

**EPA/600/P-95/002Fa**  
**August 1997**

**VOLUME I - GENERAL FACTORS**

**EXPOSURE FACTORS HANDBOOK**

Update to Exposure Factors Handbook  
EPA/600/8-89/043 - May 1989

Office of Research and Development  
National Center for Environmental Assessment  
U.S. Environmental Protection Agency  
Washington, DC 20460

## **DISCLAIMER**

This document has been reviewed in accordance with U.S. Environmental Protection Agency policy and approved for publication. Mention of trade names or commercial products does not constitute endorsement or recommendation for use.

**CONTENTS**Page No.**VOLUME I**

1.	INTRODUCTION .....	1-1
1.1.	PURPOSE .....	1-1
1.2.	INTENDED AUDIENCE .....	1-1
1.3.	BACKGROUND .....	1-1
1.3.1.	Selection of Studies for the Handbook .....	1-1
1.3.2.	Using the Handbook in an Exposure Assessment .....	1-3
1.3.3.	Approach Used to Develop Recommendations for Exposure Factors .....	1-4
1.3.4.	Characterizing Variability .....	1-5
1.4.	GENERAL EQUATION FOR CALCULATING DOSE .....	1-11
1.5.	RESEARCH NEEDS .....	1-14
1.6.	ORGANIZATION .....	1-15
1.7.	REFERENCES FOR CHAPTER 1 .....	1-16
APPENDIX 1A	.....	1A-1
2.	VARIABILITY AND UNCERTAINTY .....	2-1
2.1.	VARIABILITY VERSUS UNCERTAINTY .....	2-1
2.2.	TYPES OF VARIABILITY .....	2-2
2.3.	CONFRONTING VARIABILITY .....	2-3
2.4.	CONCERN ABOUT UNCERTAINTY .....	2-3
2.5.	TYPES OF UNCERTAINTY AND REDUCING UNCERTAINTY .....	2-4
2.6.	ANALYZING VARIABILITY AND UNCERTAINTY .....	2-4
2.7.	PRESENTING RESULTS OF VARIABILITY AND UNCERTAINTY ANALYSIS .....	2-6
2.8.	REFERENCES FOR CHAPTER 2 .....	2-7
3.	DRINKING WATER INTAKE .....	3-1
3.1.	BACKGROUND .....	3-1
3.2.	KEY GENERAL POPULATION STUDIES ON DRINKING WATER INTAKE .....	3-1
3.3.	RELEVANT GENERAL POPULATION STUDIES ON DRINKING WATER INTAKE .....	3-9
3.4.	PREGNANT AND LACTATING WOMEN .....	3-17
3.5.	HIGH ACTIVITY LEVELS/HOT CLIMATES .....	3-20
3.6.	RECOMMENDATIONS .....	3-23
3.7.	REFERENCES FOR CHAPTER 3 .....	3-30
4.	SOIL INGESTION AND PICA .....	4-1
4.1.	BACKGROUND .....	4-1
4.2.	KEY STUDIES ON SOIL INTAKE AMONG CHILDREN .....	4-1
4.3.	RELEVANT STUDIES ON SOIL INTAKE AMONG CHILDREN .....	4-11
4.4.	SOIL INTAKE AMONG ADULTS .....	4-16
4.5.	PREVALENCE OF PICA .....	4-17
4.6.	DELIBERATE SOIL INGESTION AMONG CHILDREN .....	4-18
4.7.	RECOMMENDATIONS .....	4-20
4.8.	REFERENCES FOR CHAPTER 4 .....	4-25

## CONTENTS (continued)

	<u>Page No.</u>
5. INHALATION ROUTE .....	5-1
5.1. EXPOSURE EQUATION FOR INHALATION .....	5-1
5.2. INHALATION RATE .....	5-1
5.2.1. Background .....	5-1
5.2.2. Key Inhalation Rate Studies .....	5-3
5.2.3. Relevant Inhalation Rate Studies .....	5-16
5.2.4. Recommendations .....	5-22
5.3. REFERENCES FOR CHAPTER 5 .....	5-27
APPENDIX 5A .....	5A-1
6. DERMAL ROUTE .....	6-1
6.1. EQUATION FOR DERMAL DOSE .....	6-1
6.2. SURFACE AREA .....	6-2
6.2.1. Background .....	6-2
6.2.2. Measurement Techniques .....	6-2
6.2.3. Key Body Surface Area Studies .....	6-2
6.2.4. Relevant Surface Area Studies .....	6-4
6.2.5. Application of Body Surface Area Data .....	6-4
6.3. SOIL ADHERENCE TO SKIN .....	6-6
6.3.1. Background .....	6-6
6.3.2. Key Soil Adherence to Skin Studies .....	6-6
6.3.3. Relevant Soil Adherence to Skin Studies .....	6-6
6.4. RECOMMENDATIONS .....	6-8
6.4.1. Body Surface Area .....	6-8
6.4.2. Soil Adherence to Skin .....	6-8
6.5. REFERENCES FOR CHAPTER 6 .....	6-10
APPENDIX 6A .....	6A-1
7. BODY WEIGHT STUDIES .....	7-1
7.1. KEY BODY WEIGHT STUDY .....	7-1
7.2. RELEVANT BODY WEIGHT STUDIES .....	7-4
7.3. RECOMMENDATIONS .....	7-10
7.4. REFERENCES FOR CHAPTER 7 .....	7-11
8. LIFETIME .....	8-1
8.1. KEY STUDY ON LIFETIME .....	8-1
8.2. RECOMMENDATIONS .....	8-1
8.3. REFERENCES FOR CHAPTER 8 .....	8-1

## LIST OF TABLES

Page No.

### VOLUME I

Table 1-1.	Considerations Used to Rate Confidence in Recommended Values .....	1-6
Table 1-2.	Summary of Exposure Factor Recommendations and Confidence Ratings .....	1-7
Table 1-3.	Characterization of Variability in Exposure Factors .....	1-10
Table 1A-1.	Procedures for Modifying IRIS Risk Values for Non-standard Populations .....	1A-4
Table 2-1.	Four Strategies for Confronting Variability .....	2-3
Table 2-2.	Three Types of Uncertainty and Associated Sources and Examples .....	2-5
Table 2-3.	Approaches to Quantitative Analysis of Uncertainty .....	2-6
Table 3-1.	Daily Total Tapwater Intake Distribution for Canadians, by Age Group (approx. 0.20 L increments, both sexes, combined seasons) .....	3-2
Table 3-2.	Average Daily Tapwater Intake of Canadians (expressed as milliliters per kilogram body weight) .....	3-3
Table 3-3.	Average Daily Total Tapwater Intake of Canadians, by Age and Season (L/day) .....	3-3
Table 3-4.	Average Daily Total Tapwater Intake of Canadians as a Function of Level of Physical Activity at Work and in Spare Time (16 years and older, combined seasons, L/day) .....	3-3
Table 3-5.	Average Daily Tapwater Intake by Canadians, Apportioned Among Various Beverages (both sexes, by age, combined seasons, L/day) .....	3-4
Table 3-6.	Total Tapwater Intake (mL/day) for Both Sexes Combined .....	3-5
Table 3-7.	Total Tapwater Intake (mL/kg-day) for Both Sexes Combined .....	3-6
Table 3-8.	Summary of Tapwater Intake by Age .....	3-7
Table 3-9.	Total Tapwater Intake (as percent of total water intake) by Broad Age Category .....	3-7
Table 3-10.	General Dietary Sources of Tapwater for Both Sexes .....	3-8
Table 3-11.	Summary Statistics for Best-Fit Lognormal Distributions for Water Intake Rates .....	3-9
Table 3-12.	Estimated Quantiles and Means for Total Tapwater Intake Rates (mL/day) .....	3-10
Table 3-13.	Assumed Tapwater Content of Beverages .....	3-10
Table 3-14.	Intake of Total Liquid, Total Tapwater, and Various Beverages (L/day) .....	3-11
Table 3-15.	Summary of Total Liquid and Total Tapwater Intake for Males and Females (L/day) .....	3-12
Table 3-16.	Measured Fluid Intakes (mL/day) .....	3-13
Table 3-17.	Intake Rates of Total Fluids and Total Tapwater by Age Group .....	3-14
Table 3-18.	Mean and Standard Error for the Daily Intake of Beverages and Tapwater by Age .....	3-14
Table 3-19.	Average Total Tapwater Intake Rate by Sex, Age, and Geographic Area .....	3-15
Table 3-20.	Frequency Distribution of Total Tapwater Intake Rates .....	3-15
Table 3-21.	Mean Per Capita Drinking Water Intake Based on USDA, CSFII Data From 1989-91 (mL/day) .....	3-16
Table 3-22.	Number of Respondents that Consumed Tapwater at a Specified Daily Frequency .....	3-18
Table 3-23.	Number of Respondents that Consumed Juice Reconstituted with Tapwater at a Specified Daily Frequency .....	3-19
Table 3-24.	Total Fluid Intake of Women 15-49 Years Old .....	3-20
Table 3-25.	Total Tapwater Intake of Women 15-49 Years Old .....	3-21
Table 3-26.	Total Fluid (mL/Day) Derived from Various Dietary Sources by Women Aged 15-49 Years .....	3-21
Table 3-27.	Water Intake at Various Activity Levels (L/hr) .....	3-22

## LIST OF TABLES (continued)

	<u>Page No.</u>
Table 3-28.	Planning Factors for Individual Tapwater Consumption . . . . . 3-23
Table 3-29.	Drinking Water Intake Surveys . . . . . 3-24
Table 3-30.	Summary of Recommended Drinking Water Intake Rates . . . . . 3-26
Table 3-31.	Total Tapwater Consumption Rates From Key Studies . . . . . 3-26
Table 3-32.	Daily Tapwater Intake Rates From Relevant Studies . . . . . 3-26
Table 3-33.	Key Study Tapwater Intake Rates for Children . . . . . 3-27
Table 3-34.	Summary of Intake Rates for Children in Relevant Studies . . . . . 3-27
Table 3-35.	Confidence in Tapwater Intake Recommendations . . . . . 3-29
Table 4-1.	Estimated Daily Soil Ingestion Based on Aluminum, Silicon, and Titanium Concentrations . . . 4-2
Table 4-2.	Calculated Soil Ingestion by Nursery School Children . . . . . 4-3
Table 4-3.	Calculated Soil Ingestion by Hospitalized, Bedridden Children . . . . . 4-3
Table 4-4.	Mean and Standard Deviation Percentage Recovery of Eight Tracer Elements . . . . . 4-5
Table 4-5.	Soil and Dust Ingestion Estimates for Children Aged 1-4 Years . . . . . 4-5
Table 4-6.	Average Daily Soil Ingestion Values Based on Aluminum, Silicon, and Titanium as Tracer Elements . . . . . 4-6
Table 4-7.	Geometric Mean (GM) and Standard Deviation (GSD) LTM Values for Children at Daycare Centers and Campgrounds . . . . . 4-7
Table 4-8.	Estimated Geometric Mean LTM Values of Children Attending Daycare Centers According to Age, Weather Category, and Sampling Period . . . . . 4-8
Table 4-9.	Distribution of Average (Mean) Daily Soil Ingestion Estimates Per Child for 64 Children (mg/day) . . . . . 4-9
Table 4-10.	Estimated Distribution of Individual Mean Daily Soil Ingestion Based on Data for 64 Subjects Projected Over 365 Days . . . . . 4-10
Table 4-11.	Estimates of Soil Ingestion for Children . . . . . 4-12
Table 4-12.	Estimated Soil Ingestion Rate Summary Statistics and Parameters for Distributions Using Binder et al. (1986) Data with Actual Fecal Weights . . . . . 4-13
Table 4-13.	Tukey's Multiple Comparison of Mean Log Tracer Recovery in Adults Ingesting Known Quantities of Soil . . . . . 4-14
Table 4-14.	Positive/Negative Error (bias) in Soil Ingestion Estimates in the Calabrese et al. (1989) Mass-balance Study: Effect on Mean Soil Ingestion Estimate (mg/day) . . . . . 4-15
Table 4-15.	Soil Ingestion Rates for Assessment Purposes . . . . . 4-16
Table 4-16.	Estimates of Soil Ingestion for Adults . . . . . 4-17
Table 4-17.	Adult Daily Soil Ingestion by Week and Tracer Element After Subtracting Food and Capsule Ingestion, Based on Median Amherst Soil Concentrations: Means and Medians Over Subjects (mg) . . . . . 4-18
Table 4-18.	Daily Soil Ingestion Estimation in a Soil-Pica Child by Tracer and by Week (mg/day) . . . . . 4-19
Table 4-19.	Ratios of Soil, Dust, and Residual Fecal Samples in the Pica Child . . . . . 4-19
Table 4-20.	Soil Intake Studies . . . . . 4-22
Table 4-21.	Confidence in Soil Intake Recommendation . . . . . 4-24
Table 4-22.	Summary of Estimates of Soil Ingestion By Children . . . . . 4-25
Table 4-23.	Summary of Recommended Values for Soil Ingestion . . . . . 4-25

## LIST OF TABLES (continued)

		<u>Page No.</u>
Table 5-1.	Calibration and Field Protocols for Self-Monitoring of Activities Grouped by Subject Panels . . . . .	5-4
Table 5-2.	Subject Panel Inhalation Rates by Mean VR, Upper Percentiles, and Self-Estimated Breathing Rates . . . . .	5-5
Table 5-3.	Distribution of Predicted IR by Location and Activity Levels for Elementary and High School Students . . . . .	5-6
Table 5-4.	Average Hours Spent Per Day in a Given Location and Activity Level for Elementary (EL) and High School (HS) Students . . . . .	5-6
Table 5-5.	Distribution Patterns of Daily Inhalation Rates for Elementary (EL) and High School (HS) Students Grouped by Activity Level . . . . .	5-7
Table 5-6.	Summary of Average Inhalation Rates (m <sup>3</sup> /hr) by Age Group and Activity Levels for Laboratory Protocols . . . . .	5-8
Table 5-7.	Summary of Average Inhalation Rates (m <sup>3</sup> /hr) by Age Group and Activity Levels in Field Protocols . . . . .	5-9
Table 5-8.	Distributions of Individual and Group Inhalation/Ventilation Rate for Outdoor Workers . . . . .	5-10
Table 5-9.	Individual Mean Inhalation Rate (m <sup>3</sup> /hr) by Self-Estimated Breathing Rate or Job Activity Category for Outdoor Workers . . . . .	5-10
Table 5-10.	Comparisons of Estimated Basal Metabolic Rates (BMR) with Average Food-Energy Intakes for Individuals Sampled in the 1977-78 NFCS . . . . .	5-12
Table 5-11.	Daily Inhalation Rates Calculated from Food-Energy Intakes . . . . .	5-13
Table 5-12.	Daily Inhalation Rates Obtained from the Ratios of Total Energy Expenditure to Basal Metabolic Rate (BMR) . . . . .	5-14
Table 5-13.	Daily Inhalation Rates Based on Time-Activity Survey . . . . .	5-15
Table 5-14.	Inhalation Rates for Short-Term Exposures . . . . .	5-16
Table 5-15.	Daily Inhalation Rates Estimated From Daily Activities . . . . .	5-17
Table 5-16.	Summary of Human Inhalation Rates for Men, Women, and Children by Activity Level (m <sup>3</sup> /hour) . . . . .	5-18
Table 5-17.	Activity Pattern Data Aggregated for Three Microenvironments by Activity Level for all Age Groups . . . . .	5-18
Table 5-18.	Summary of Daily Inhalation Rates Grouped by Age and Activity Level . . . . .	5-18
Table 5-19.	Distribution Pattern of Predicted VR and EVR (equivalent ventilation rate) for 20 Outdoor Workers . . . . .	5-20
Table 5-20.	Distribution Pattern of Inhalation Rate by Location and Activity Type for 20 Outdoor Workers . . . . .	5-21
Table 5-21.	Actual Inhalation Rates Measured at Four Ventilation Levels . . . . .	5-22
Table 5-22.	Confidence in Inhalation Rate Recommendations . . . . .	5-23
Table 5-23.	Summary of Recommended Values for Inhalation . . . . .	5-24
Table 5-24.	Summary of Inhalation Rate Studies . . . . .	5-25
Table 5-25.	Summary of Adult Inhalation Rates for Short-Term Exposure Studies . . . . .	5-26
Table 5-26.	Summary of Children's (18 years old or less) Inhalation Rates for Long-Term Exposure Studies . . . . .	5-26
Table 5-27.	Summary of Children's Inhalation Rates for Short-Term Exposure Studies . . . . .	5-26
Table 5A-1.	Mean Minute Ventilation (V <sub>E</sub> , L/min) by Group and Activity for Laboratory Protocols . . . . .	5A-3
Table 5A-2.	Mean Minute Ventilation (V <sub>E</sub> , L/min) by Group and Activity for Field Protocols . . . . .	5A-3

## LIST OF TABLES (continued)

Page No.

Table 5A-3.	Characteristics of Individual Subjects: Anthropometric Data, Job Categories, Calibration Results . . . . .	5A-4
Table 5A-4.	Statistics of the Age/Gender Cohorts Used to Develop Regression Equations for Predicting Basal Metabolic Rates (BMR) . . . . .	5A-4
Table 5A-5.	Selected Ventilation Values During Different Activity Levels Obtained From Various Literature Sources . . . . .	5A-5
Table 5A-6.	Estimated Minute Ventilation Associated with Activity Level for Average Male Adult . . . . .	5A-6
Table 5A-7.	Minute Ventilation Ranges by Age, Sex, and Activity Level . . . . .	5A-7
Table 6-1.	Summary of Equation Parameters for Calculating Adult Body Surface Area . . . . .	6-12
Table 6-2.	Surface Area of Adult Males in Square Meters . . . . .	6-13
Table 6-3.	Surface Area of Adult Females in Square Meters . . . . .	6-13
Table 6-4.	Surface Area of Body Part for Adults (m <sup>2</sup> ) . . . . .	6-14
Table 6-5.	Percentage of Total Body Surface Area by Part for Adults . . . . .	6-14
Table 6-6.	Total Body Surface Area of Male Children in Square Meters . . . . .	6-15
Table 6-7.	Total Body Surface Area of Female Children in Square Meters . . . . .	6-15
Table 6-8.	Percentage of Total Body Surface Area by Body Part for Children . . . . .	6-16
Table 6-9.	Descriptive Statistics for Surface Area/BodyWeight (SA/WB) Ratios (m <sup>2</sup> /kg) . . . . .	6-17
Table 6-10.	Statistical Results for Total Body Surface Area Distributions (m <sup>2</sup> ) . . . . .	6-17
Table 6-11.	Summary of Field Studies . . . . .	6-20
Table 6-12.	Geometric Mean and Geometric Standard Deviations of Soil Adherence by Activity and Body Region . . . . .	6-22
Table 6-13.	Summary of Surface Area Studies . . . . .	6-24
Table 6-14.	Summary of Recommended Values for Skin Surface Area . . . . .	6-25
Table 6-15.	Confidence in Body Surface Area Measurement Recommendations . . . . .	6-25
Table 6-16.	Recommendations for Adult Body Surface Area . . . . .	6-26
Table 6-17.	Summary of Soil Adherence Studies . . . . .	6-26
Table 6-18.	Confidence in Soil Adherence to Skin Recommendations . . . . .	6-27
Table 6-A1.	Estimated Parameter Values for Different Age Intervals . . . . .	6-A5
Table 6-A2.	Summary of Surface Area Parameter Values for the DuBois and DuBois Model . . . . .	6-A6
Table 7-1.	Smoothed Percentiles of Weight (in kg) by Sex and Age: Statistics from NCHS and Data from Fels Research Institute, Birth to 36 Months . . . . .	7-1
Table 7-2.	Body Weights of Adults (kilograms) . . . . .	7-4
Table 7-3.	Body Weights of Children (kilograms) . . . . .	7-4
Table 7-4.	Weight in Kilograms for Males 18-74 Years of Age--Number Examined, Mean, Standard Deviation, and Selected Percentiles, by Race and Age: United States, 1976-1980 . . . . .	7-5
Table 7-5.	Weight in Kilograms for Females 18-74 Years of Age--Number Examined, Mean, Standard Deviation, and Selected Percentiles, by Race and Age: United States, 1976-1980 . . . . .	7-6
Table 7-6.	Weight in Kilograms for Males 6 Months-19 Years of Age--Number Examined, Mean, Standard Deviation, and Selected Percentiles, by Sex and Age: United States, 1976-1980 . . . . .	7-7
Table 7-7.	Weight in Kilograms for Females 6 Months-19 Years of Age--Number Examined, Mean, Standard Deviation, and Selected Percentiles, by Sex and Age: United States, 1976-1980 . . . . .	7-8



**LIST OF TABLES (continued)**Page No.

Table 7-8.	Statistics for Probability Plot Regression Analyses Female's Body Weights 6 Months to 20 Years of Age .....	7-9
Table 7-9.	Statistics for Probability Plot Regression Analyses Male's Body Weights 6 Months to 20 Years of Age .....	7-10
Table 7-10.	Summary of Body Weight Studies .....	7-11
Table 7-11.	Summary of Recommended Values for Body Weight .....	7-11
Table 7-12.	Confidence in Body Weight Recommendations .....	7-12
Table 8-1.	Expectation of Life at Birth, 1970 to 1993, and Projections, 1995 to 2010 .....	8-2
Table 8-2.	Expectation of Life by Race, Sex, and Age: 1992 .....	8-3
Table 8-3.	Confidence in Lifetime Expectancy Recommendations .....	8-5

**LIST OF FIGURES**Page No.**VOLUME I**

Figure 1-1.	Schematic of Dose and Exposure: Oral Route . . . . .	1-13
Figure 1-2.	Road Map to Exposure Factor Recommendations . . . . .	1-17
Figure 6-1.	Schematic of Dose and Exposure: Dermal Route . . . . .	6-12
Figure 6-2.	SA/BW Distributions for Infants, Adults, and All Ages Combined . . . . .	6-18
Figure 6-3.	Surface Area Frequency Distribution: Men and Women . . . . .	6-19
Figure 7-1.	Weight by Age Percentiles for Boys Aged Birth-36 Months . . . . .	7-2
Figure 7-2.	Weight by Age Percentiles for Girls Aged Birth-36 Months . . . . .	7-3

**EPA/600/P-95/002Fa**  
**August 1997**

**VOLUME II - FOOD INGESTION FACTORS**

**EXPOSURE FACTORS HANDBOOK**

Update to Exposure Factors Handbook  
EPA/600/8-89/043 - May 1989

Office of Research and Development  
National Center for Environmental Assessment  
U.S. Environmental Protection Agency  
Washington, DC 20460

## **DISCLAIMER**

This document has been reviewed in accordance with U.S. Environmental Protection Agency policy and approved for publication. Mention of trade names or commercial products does not constitute endorsement or recommendation for use.

**CONTENTS (continued)**Page No.**VOLUME II**

9.	INTAKE OF FRUITS AND VEGETABLES .....	9-1
9.1.	BACKGROUND .....	9-1
9.2.	INTAKE STUDIES .....	9-2
9.2.1.	U.S. Department of Agriculture Nationwide Food Consumption Survey and Continuing Survey of Food Intake by Individuals .....	9-2
9.2.2.	Key Fruits and Vegetables Intake Study Based on the USDA CSFII .....	9-2
9.2.3.	Relevant Fruits and Vegetables Intake Studies .....	9-4
9.2.4.	Relevant Fruits and Vegetables Serving Size Study Based on the USDA NFCS .....	9-6
9.2.5.	Conversion Between As Consumed and Dry Weight Intake Rates .....	9-7
9.3.	RECOMMENDATIONS .....	9-7
9.4.	REFERENCES FOR CHAPTER 9 .....	9-8
APPENDIX 9A	.....	9A-1
APPENDIX 9B	.....	9B-1
10.	INTAKE OF FISH AND SHELLFISH .....	10-1
10.1.	BACKGROUND .....	10-1
10.2.	KEY GENERAL POPULATION STUDIES .....	10-2
10.3.	RELEVANT GENERAL POPULATION STUDIES .....	10-6
10.4.	KEY RECREATIONAL (MARINE FISH STUDIES) .....	10-8
10.5.	RELEVANT RECREATIONAL MARINE STUDIES .....	10-10
10.6.	KEY FRESHWATER RECREATIONAL STUDIES .....	10-12
10.7.	RELEVANT FRESHWATER RECREATIONAL STUDIES .....	10-18
10.8.	NATIVE AMERICAN FRESHWATER STUDIES .....	10-20
10.9.	OTHER FACTORS .....	10-24
10.10.	RECOMMENDATIONS .....	10-25
10.10.1.	Recommendations - General Population .....	10-25
10.10.2.	Recommendations - Recreational Marine Anglers .....	10-26
10.10.3.	Recommendations - Recreational Freshwater Anglers .....	10-26
10.10.4.	Recommendations - Native American Subsistence Populations .....	10-26
10.11.	REFERENCES FOR CHAPTER 10 .....	10-27
APPENDIX 10A	.....	10A-1
APPENDIX 10B	.....	10B-1
APPENDIX 10C	.....	10C-1
11.	INTAKE OF MEAT AND DAIRY PRODUCTS .....	11-1
11.1.	INTAKE STUDIES .....	11-1
11.1.1.	U.S. Department of Agriculture Nationwide Food Consumption Survey and Continuing Survey of Food Intake by Individuals .....	11-1
11.1.2.	Key Meat and Dairy Products Intake Study Based on the CSFII .....	11-2
11.1.3.	Relevant Meat and Dairy Products Intake Studies .....	11-3

## CONTENTS (continued)

	<u>Page No.</u>
11.2. FAT CONTENT OF MEAT AND DAIRY PRODUCTS .....	11-6
11.3. CONVERSION BETWEEN AS CONSUMED AND DRY WEIGHT INTAKE RATES .....	11-7
11.4. RECOMMENDATIONS .....	11-7
11.5. REFERENCES FOR CHAPTER 11 .....	11-7
APPENDIX 11A .....	11A-1
12. INTAKE OF GRAIN PRODUCTS .....	12-1
12.1. INTAKE STUDIES .....	12-1
12.1.1. U.S. Department of Agriculture Nationwide Food Consumption Survey and Continuing Survey of Food Intake by Individuals .....	12-1
12.1.2. Key Grain Products Intake Studies Based on the CSFII .....	12-2
12.1.3. Relevant Grain Products Intake Studies .....	12-2
12.1.4. Key Grain Products Serving Size Study Based on the USDA NFCS .....	12-4
12.2. CONVERSION BETWEEN AS CONSUMED AND DRY WEIGHT INTAKE RATES .....	12-4
12.3. RECOMMENDATIONS .....	12-5
12.4. REFERENCES FOR CHAPTER 12 .....	12-5
APPENDIX 12A .....	12A-1
13. INTAKE RATES FOR VARIOUS HOME PRODUCED FOOD ITEMS .....	13-1
13.1. BACKGROUND .....	13-1
13.2. METHODS .....	13-2
13.3. RESULTS .....	13-7
13.4. ADVANTAGES AND LIMITATIONS .....	13-9
13.5. RECOMMENDATIONS .....	13-10
13.6. REFERENCES FOR CHAPTER 13 .....	13-10
APPENDIX 13A .....	13A-1
14. BREAST MILK INTAKE .....	14-1
14.1. BACKGROUND .....	14-1
14.2. KEY STUDIES ON BREAST MILK INTAKE .....	14-1
14.3. RELEVANT STUDIES ON BREAST MILK INTAKE .....	14-4
14.4. KEY STUDIES ON LIPID CONTENT AND FAT INTAKE FROM BREAST MILK .....	14-5
14.5. OTHER FACTORS .....	14-6
14.6. RECOMMENDATIONS .....	14-7
14.7. REFERENCES FOR CHAPTER 14 .....	14-8

**LIST OF TABLES (continued)**Page No.**VOLUME II**

Table 9-1.	Sub-category Codes and Definitions Used in the CSFII 1989-91 Analysis	9-9
Table 9-2.	Weighted and Unweighted Number of Observations for 1989-91 CSFII Data Used in Analysis of Food Intake	9-10
Table 9-3.	Per Capita Intake of Total Fruits (g/kg-day as consumed)	9-11
Table 9-4.	Per Capita Intake of Total Vegetables (g/kg-day as consumed)	9-12
Table 9-5.	Per Capita Intake of Individual Fruits and Vegetables (g/kg-day as consumed)	9-13
Table 9-6.	Per Capita Intake of USDA Categories of Fruits and Vegetables (g/kg-day as consumed)	9-19
Table 9-7.	Per Capita Intake of Exposed Fruits (g/kg-day as consumed)	9-20
Table 9-8.	Per Capita Intake of Protected Fruits (g/kg-day as consumed)	9-21
Table 9-9.	Per Capita Intake of Exposed Vegetables (g/kg-day as consumed)	9-22
Table 9-10.	Per Capita Intake of Protected Vegetables (g/kg-day as consumed)	9-23
Table 9-11.	Per Capita Intake of Root Vegetables (g/kg-day as consumed)	9-24
Table 9-12.	Mean Daily Intake of Fruits and Vegetables Per Individual in a Day for USDA 1977-78, 87-88, 89-91, 94, and 95 Surveys	9-25
Table 9-13.	Mean Per Capita Intake Rates (as consumed) for Fruits and Vegetables Based on All Sex/Age/Demographic Subgroups	9-26
Table 9-14.	Mean Total Fruit Intake (as consumed) in a Day by Sex and Age (1977-1978)	9-33
Table 9-15.	Mean Total Fruit Intake (as consumed) in a Day by Sex and Age (1987-1988)	9-33
Table 9-16.	Mean Total Vegetable Intake (as consumed) in a Day by Sex and Age (1977-1978)	9-34
Table 9-17.	Mean Total Vegetable Intake (as consumed) in a Day by Sex and Age (1987-1988)	9-34
Table 9-18.	Mean Total Fruit Intake (as consumed) in a Day by Sex and Age (1994 and 1995)	9-35
Table 9-19.	Mean Total Vegetable Intake (as consumed) in a Day by Sex and Age (1994 and 1995)	9-35
Table 9-20.	Mean Per Capita Intake of Fats and Oils (g/day as consumed) in a Day by Sex and Age (1994 and 1995)	9-36
Table 9-21.	Mean and Standard Error for the Per Capita Daily Intake of Food Class and Subclass by Region (g/day as consumed)	9-36
Table 9-22.	Mean and Standard Error for the Daily Intake of Food Subclasses Per Capita by Age (g/day as consumed)	9-37

## LIST OF TABLES (continued)

	<u>Page No.</u>
Table 9-23.	Consumption of Foods (g dry weight/day) for Different Age Groups and Estimated Lifetime Average Daily Food Intakes for a US Citizen (averaged across sex) Calculated from the FDA Diet Data . . . . . 9-37
Table 9-24.	Mean Daily Intake of Foods (grams) Based on the Nutrition Canada Dietary Survey . . . . . 9-38
Table 9-25.	Per Capita Consumption of Fresh Fruits and Vegetables in 1991 . . . . . 9-38
Table 9-26.	Quantity (as consumed) of Fruits and Vegetables Consumed Per Eating Occasion and the Percentage of Individuals Using These Foods in Three Days . . . . . 9-39
Table 9-27.	Mean Moisture Content of Selected Fruits and Vegetables Expressed as Percentages of Edible Portions . . . . . 9-40
Table 9-28.	Summary of Fruit and Vegetable Intake Studies . . . . . 9-43
Table 9-29.	Summary of Recommended Values for Per Capita Intake of Fruits and Vegetables . . . . . 9-44
Table 9-30.	Confidence in Fruit and Vegetable Intake Recommendations . . . . . 9-45
Table 9A-1.	Fraction of Grain and Meat Mixture Intake Represented by Various Food Items/Groups . . . . . 9A-3
Table 9 B.	Food Codes and Definitions Used in Analysis of the 1989-91 USDA CSFII Data . . . . . 9 B-3
Table 10-1.	Total Fish Consumption by Demographic Variables . . . . . 10-30
Table 10-2.	Mean and 95th Percentile of Fish Consumption (g/day) by Sex and Age . . . . . 10-31
Table 10-3.	Percent Distribution of Total Fish Consumption for Females by Age . . . . . 10-32
Table 10-4.	Percent Distribution of Total Fish Consumption for Males by Age . . . . . 10-32
Table 10-5.	Mean Total Fish Consumption by Species . . . . . 10-33
Table 10-6.	Best Fits of Lognormal Distributions Using the NonLinear Optimization (NLO) Method . . . . . 10-33
Table 10-7.	Per Capita Distribution of Fish Intake (g/day) by Habitat and Fish Type for the U.S. Population (Uncooked Fish Weight) . . . . . 10-34
Table 10-8.	Per Capita Distribution of Fish (Finfish and Shellfish) Intake (g/day) by Habitat for Consumers Only (Uncooked Fish Weight) . . . . . 10-35
Table 10-9.	Per Capita Distribution of Fish Intake (mg/kg-day) by Habitat and Fish Type for U.S. Population (Uncooked Fish Weight) . . . . . 10-36
Table 10-10.	Per Capita Distribution of Fish (Finfish and Shellfish) Intake (mg/kg-day) by Habitat for Consumers Only (Uncooked Fish Weight) . . . . . 10-37
Table 10-11.	Per Capita Distribution of Fish Intake (g/day) by Habitat and Fish Type for the U.S. Population (Cooked Fish Weight - As Consumed) . . . . . 10-38
Table 10-12.	Per Capita Distribution of Fish Intake (g/day) by Habitat for Consumers Only (Cooked Fish Weight - As Consumed) . . . . . 10-39
Table 10-13.	Per Capita Distribution of Fish (Finfish and Shellfish) Intake (g/day) for the U.S. Population by Age and Gender - As Consumed (Freshwater and Estuarine) . . . . . 10-40
Table 10-14.	Per Capita Distribution of Fish (Finfish and Shellfish) Intake (g/day) for the U.S. Population by Age and Gender - As Consumed (Marine) . . . . . 10-40
Table 10-15.	Per Capita Distribution of Fish (Finfish and Shellfish) Intake (g/day) for the U.S. Population by Age and Gender - As Consumed (All Fish) . . . . . 10-41
Table 10-16.	Per Capita Distribution of Fish (Finfish and Shellfish) Intake (grams/day) for the U.S. Population Aged 18 Years and Older by Habitat - As Consumed . . . . . 10-41
Table 10-17.	Per Capita Distribution of Fish (Finfish and Shellfish) Intake (mg/kg-day) for the U.S. Population by Age and Gender - As Consumed (Freshwater and Estuarine) . . . . . 10-42



**LIST OF TABLES (continued)**Page No.

Table 10-18.	Per Capita Distribution of Fish (Finfish and Shellfish) Intake (mg/kg-day) for the U.S. Population by Age and Gender - As Consumed (Marine) . . . . .	10-42
Table 10-19.	Per Capita Distribution of Fish (Finfish and Shellfish) Intake (mg/kg-day) for the U.S. Population by Age and Gender - As Consumed (All Fish) . . . . .	10-43
Table 10-20.	Per Capita Distribution of Fish (Finfish and Shellfish) Intake (mg/kg-day) for the U.S. Population Aged 18 Years and Older by Habitat - As Consumed . . . . .	10-43
Table 10-21.	Per Capita Distribution of Fish (Finfish and Shellfish) Intake (g/day) for Consumers Only by Age and Gender - As Consumed (Freshwater and Estuarine) . . . . .	10-44
Table 10-22.	Per Capita Distribution of Fish (Finfish and Shellfish) Intake (g/day) for Consumers Only by Age and Gender - As Consumed (Marine) . . . . .	10-44
Table 10-23.	Per Capita Distribution of Fish (Finfish and Shellfish) Intake (g/day) for Consumers Only by Age and Gender - As Consumed (All Fish) . . . . .	10-45
Table 10-24.	Per Capita Distribution of Fish (Finfish and Shellfish) Intake (g/day) for Consumers Only Aged 18 Years and Older by Habitat - As Consumed . . . . .	10-45
Table 10-25.	Per Capita Distribution of Fish (Finfish and Shellfish) Intake (mg/kg-day) for Consumers Only by Age and Gender - As Consumed (Freshwater and Estuarine) . . . . .	10-46
Table 10-26.	Per Capita Distribution of Fish (Finfish and Shellfish) Intake (mg/kg-day) for Consumers Only by Age and Gender - As Consumed (Marine) . . . . .	10-46
Table 10-27.	Per Capita Distribution of Fish (Finfish and Shellfish) Intake (mg/kg-day) for Consumers Only by Age and Gender - As Consumed (All Fish) . . . . .	10-47
Table 10-28.	Per Capita Distribution of Fish (Finfish and Shellfish) Intake (mg/kg-day) for Consumers Only Aged 18 Years and Older by Habitat - As Consumed . . . . .	10-47
Table 10-29.	Per Capita Distribution of Fish (Finfish and Shellfish) Intake (g/day) for the U.S. Population by Age and Gender - Uncooked Fish Weight (Freshwater and Estuarine) . . . . .	10-48
Table 10-30.	Per Capita Distribution of Fish (Finfish and Shellfish) Intake (g/day) for the U.S. Population by Age and Gender - Uncooked Fish Weight (Marine) . . . . .	10-48
Table 10-31.	Per Capita Distribution of Fish (Finfish and Shellfish) Intake (g/day) for the U.S. Population by Age and Gender - Uncooked Fish Weight (All Fish) . . . . .	10-49
Table 10-32.	Per Capita Distribution of Fish (Finfish and Shellfish) Intake (g/day) for the U.S. Population Aged 18 Years and Older by Habitat - Uncooked Fish Weight . . . . .	10-49
Table 10-33.	Per Capita Distribution of Fish (Finfish and Shellfish) Intake (mg/kg-day) for the U.S. Population by Age and Gender - Uncooked Fish Weight (Freshwater and Estuarine) . . . . .	10-50
Table 10-34.	Per Capita Distribution of Fish (Finfish and Shellfish) Intake (mg/kg-day) for the U.S. Population by Age and Gender - Uncooked Fish Weight (Marine) . . . . .	10-50
Table 10-35.	Per Capita Distribution of Fish (Finfish and Shellfish) Intake (mg/kg-day) for the U.S. Population by Age and Gender - Uncooked Fish Weight (All Fish) . . . . .	10-51
Table 10-36.	Per Capita Distribution of Fish (Finfish and Shellfish) Intake (mg/kg-day) for the U.S. Population Aged 18 Years and Older by Habitat - Uncooked Fish Weight . . . . .	10-51
Table 10-37.	Per Capita Distribution of Fish (Finfish and Shellfish) Intake (g/day) for Consumers Only by Age and Gender - Uncooked Fish Weight (Freshwater and Estuarine) . . . . .	10-52
Table 10-38.	Per Capita Distribution of Fish (Finfish and Shellfish) Intake (g/day) for Consumers Only by Age and Gender - Uncooked Fish Weight (Marine) . . . . .	10-52

## LIST OF TABLES (continued)

	<u>Page No.</u>
Table 10-39.	Per Capita Distribution of Fish (Finfish and Shellfish) Intake (g/day) for Consumers Only by Age and Gender - Uncooked Fish Weight (All Fish) . . . . . 10-53
Table 10-40.	Per Capita Distribution of Fish (Finfish and Shellfish) Intake (g/day) for Consumers Only Aged 18 Years and Older by Habitat - Uncooked Fish Weight . . . . . 10-53
Table 10-41.	Per Capita Distribution of Fish (Finfish and Shellfish) Intake (mg/kg-day) for Consumers Only by Age and Gender - Uncooked Fish Weight (Freshwater and Estuarine) . . . . . 10-54
Table 10-42.	Per Capita Distribution of Fish (Finfish and Shellfish) Intake (mg/kg-day) for Consumers Only by Age and Gender - Uncooked Fish Weight (Marine) . . . . . 10-54
Table 10-43.	Per Capita Distribution of Fish (Finfish and Shellfish) Intake (mg/kg-day) for Consumers Only by Age and Gender - Uncooked Fish Weight (All Fish) . . . . . 10-55
Table 10-44.	Per Capita Distribution of Fish (Finfish and Shellfish) Intake (mg/kg-day) for Consumers Only Aged 18 Years and Older by Habitat - Uncooked Fish Weight . . . . . 10-55
Table 10-45.	Distribution of Quantity of Fish Consumed (in grams) Per Eating Occasion, by Age and Sex . . . . . 10-56
Table 10-46.	Mean Fish Intake in a Day, by Sex and Age . . . . . 10-56
Table 10-47.	Percent of Respondents That Responded Yes, No, or Don't Know to Eating Seafood in 1 Month (including shellfish, eels, or squid) . . . . . 10-57
Table 10-48.	Number of Respondents Reporting Consumption of a Specified Number of Servings of Seafood in 1 Month . . . . . 10-58
Table 10-49.	Number of Respondents Reporting Monthly Consumption of Seafood That Was Purchased or Caught by Someone They Knew . . . . . 10-59
Table 10-50.	Estimated Number of Participants in Marine Recreational Fishing by State and Subregion . . . . . 10-60
Table 10-51.	Estimated Weight of Fish Caught (Catch Type A and B1) by Marine Recreational Fishermen, by Wave and Subregion . . . . . 10-61
Table 10-52.	Average Daily Intake (g/day) of Marine Finfish, by Region and Coastal Status . . . . . 10-62
Table 10-53.	Estimated Weight of Fish Caught (Catch Type A and B1) by Marine Recreational Fishermen by Species Group and Subregion, Atlantic and Gulf . . . . . 10-62
Table 10-54.	Estimated Weight of Fish Caught (Catch Type A and B1) by Marine Recreational Fishermen by Species Group and Subregion, Pacific . . . . . 10-63
Table 10-55.	Median Intake Rates Based on Demographic Data of Sport Fishermen and Their Family/Living Group . . . . . 10-63
Table 10-56.	Cumulative Distribution of Total Fish/Shellfish Consumption by Surveyed Sport Fishermen in the Metropolitan Los Angeles Area . . . . . 10-64
Table 10-57.	Catch Information for Primary Fish Species Kept by Sport Fishermen (n=1059) . . . . . 10-64
Table 10-58.	Percent of Fishing Frequency During the Summer and Fall Seasons in Commencement Bay, Washington . . . . . 10-64
Table 10-59.	Selected Percentile Consumption Estimates (g/day) for the Survey and Total Angler Populations Based on the Reanalysis of the Puffer et al. (1981) and Pierce et al. (1981) Data . . . . . 10-65
Table 10-60.	Means and Standard Deviations of Selected Characteristics by Subpopulation Groups in Everglades, Florida . . . . . 10-65
Table 10-61.	Mean Fish Intake Among Individuals Who Eat Fish and Reside in Households With Recreational Fish Consumption . . . . . 10-66

**LIST OF TABLES (continued)**Page No.

Table 10-62.	Comparison of Seven-Day Recall and Estimated Seasonal Frequency for Fish Consumption . . . . .	10-66
Table 10-63.	Distribution of Usual Fish Intake Among Survey Main Respondents Who Fished and Consumed Recreationally Caught Fish . . . . .	10-66
Table 10-64.	Estimates of Fish Intake Rates of Licensed Sport Anglers in Maine During the 1989-1990 Ice Fishing or 1990 Open-Water Seasons . . . . .	10-67
Table 10-65.	Analysis of Fish Consumption by Ethnic Groups for "All Waters" (g/day) . . . . .	10-67
Table 10-66.	Total Consumption of Freshwater Fish Caught by All Survey Respondents During the 1990 Season . . . . .	10-68
Table 10-67.	Mean Sport-Fish Consumption by Demographic Variables, Michigan Sport Anglers Fish Consumption Study, 1991-1992 . . . . .	10-68
Table 10-68.	Distribution of Fish Intake Rates (from all sources and from sport-caught sources) For 1992 Lake Ontario Anglers . . . . .	10-69
Table 10-69.	Mean Annual Fish Consumption (g/day) for Lake Ontario Anglers, 1992, by Sociodemographic Characteristics . . . . .	10-69
Table 10-70.	Percentile and Mean Intake Rates for Wisconsin Sport Anglers . . . . .	10-70
Table 10-71.	Sociodemographic Characteristics of Respondents . . . . .	10-70
Table 10-72.	Number of Grams Per Day of Fish Consumed by All Adult Respondents (Consumers and Non-consumers Combined) - Throughout the Year . . . . .	10-71
Table 10-73.	Fish Intake Throughout the Year by Sex, Age, and Location by All Adult Respondents . . . . .	10-71
Table 10-74.	Children's Fish Consumption Rates - Throughout Year . . . . .	10-72
Table 10-75.	Sociodemographic Factors and Recent Fish Consumption . . . . .	10-72
Table 10-76.	Number of Local Fish Meals Consumed Per Year by Time Period for All Respondents . . . . .	10-74
Table 10-77.	Mean Number of Local Fish Meals Consumed Per Year by Time Period for All Respondents and Consumers Only . . . . .	10-74
Table 10-78.	Mean Number of Local Fish Meals Consumed Per Year by Time Period and Selected Characteristics for All Respondents (Mohawk, N=97; Control, N=154) . . . . .	10-75
Table 10-79.	Percentage of Individuals Using Various Cooking Methods at Specified Frequencies . . . . .	10-75
Table 10-80.	Percent Moisture and Fat Content for Selected Species . . . . .	10-76
Table 10-81.	Recommendations - General Population . . . . .	10-79
Table 10-82.	Recommendations - General Population - Fish Serving Size . . . . .	10-79
Table 10-83.	Recommendations - Recreational Marine Anglers . . . . .	10-79
Table 10-84.	Recommendations - Freshwater Anglers . . . . .	10-79
Table 10-85.	Recommendations - Native American Subsistence Populations . . . . .	10-80
Table 10-86.	Summary of Fish Intake Studies . . . . .	10-81
Table 10-87.	Confidence in Fish Intake Recommendations for General Population . . . . .	10-85
Table 10-88.	Confidence in Fish Intake Recommendations for Recreational Marine Anglers . . . . .	10-86
Table 10-89.	Confidence in Recommendations for Fish Consumption - Recreational Freshwater . . . . .	10-87
Table 10-90.	Confidence in Recommendations for Native American Subsistence Fish Consumption . . . . .	10-88
Table 10B-1.	Percent of Fish Meals Prepared Using Various Cooking Methods by Residence Size . . . . .	10B-3
Table 10B-2.	Percent of Fish Meals Prepared Using Various Cooking Methods by Age . . . . .	10B-3
Table 10B-3.	Percent of Fish Meals Prepared Using Various Cooking Methods by Ethnicity . . . . .	10B-4
Table 10B-4.	Percent of Fish Meals Prepared Using Various Cooking Methods by Education . . . . .	10B-4
Table 10B-5.	Percent of Fish Meals Prepared Using Various Cooking Methods by Income . . . . .	10B-5

## LIST OF TABLES (continued)

Page No.

Table 10B-6.	Percent of Fish Meals Where Fat was Trimmed or Skin was Removed, by Demographic Variables	10B-6
Table 10B-7.	Method of Cooking of Most Common Species Kept by Sportfishermen	10B-7
Table 10B-8.	Adult Consumption of Fish Parts	10B-7
Table 10C-1.	Daily Average Per Capita Estimates of Fish Consumption U.S. Population - Mean Consumption by Species Within Habitat - As Consumed Fish	10C-3
Table 10C-2.	Daily Average Per Capita Estimates of Fish Consumption U.S. Population - Mean Consumption by Species Within Habitat - Uncooked Fish	10C-4
Table 10C-3.	Daily Average Per Capita Estimates of Fish Consumption As Consumed Fish - Mean Consumption by Species Within Habitat - U.S. Population	10C-5
Table 10C-4.	Daily Average Per Capita Estimates of Fish Consumption Uncooked Fish - Mean Consumption by Species Within Habitat - U.S. Population	10C-6
Table 11-1.	Per Capita Intake of Total Meats (g/kg-day as consumed)	11-9
Table 11-2.	Per Capita Intake of Total Dairy Products (g/kg-day as consumed)	11-10
Table 11-3.	Per Capita Intake of Beef (g/kg-day as consumed)	11-11
Table 11-4.	Per Capita Intake of Pork (g/kg-day as consumed)	11-12
Table 11-5.	Per Capita Intake of Poultry (g/kg-day as consumed)	11-13
Table 11-6.	Per Capita Intake of Game (g/kg-day as consumed)	11-14
Table 11-7.	Per Capita Intake of Eggs (g/kg-day as consumed)	11-15
Table 11-8.	Main Daily Intake of Meat and Dairy Products Per Individual in a Day for USDA 1977-78, 87-88, 89-91, 94, and 95 Surveys	11-16
Table 11-9.	Mean Per Capita Intake Rates for Meat, Poultry, and Dairy Products (g/kg-day as consumed) Based on All Sex/Age/Demographic Subgroups	11-17
Table 11-10.	Mean Meat Intakes Per Individual in a Day, by Sex and Age (g/day as consumed) for 1977-1978	11-18
Table 11-11.	Mean Meat Intakes Per Individual in a Day, by Sex and Age (g/day as consumed) for 1987-1988	11-18
Table 11-12.	Mean Dairy Product Intakes Per Individual in a Day, by Sex and Age (g/day as consumed) for 1977-1978	11-19
Table 11-13.	Mean Dairy Product Intakes Per Individual in a Day, by Sex and Age (g/day as consumed) for 1987-1988	11-19
Table 11-14.	Mean Meat Intakes Per Individual in a Day, by Sex and Age (g/day as consumed) for 1994 and 1995	11-20
Table 11-15.	Mean Dairy Product Intakes Per Individual in a Day, by Sex and Age (g/day as consumed) for 1994 and 1995	11-20
Table 11-16.	Mean and Standard Error for the Dietary Intake of Food Sub Classes Per Capita by Age (g/day as consumed)	11-21
Table 11-17.	Mean and Standard Error for the Per Capita Daily Intake of Food Class and Sub Class by Region (g/day as consumed)	11-21
Table 11-18.	Consumption of Meat, Poultry, and Dairy Products for Different Age Groups (averaged across sex), and Estimated Lifetime Average Intakes for 70 Kg Adult Citizens Calculated from the FDA Diet Data	11-22

## LIST OF TABLES (continued)

		<u>Page No.</u>
Table 11-19.	Per Capita Consumption of Meat and Poultry in 1991 .....	11-22
Table 11-20.	Per Capita Consumption of Dairy Products in 1991 .....	11-23
Table 11-21.	Adult Mean Daily Intake (as consumed) of Meat and Poultry Grouped by Region and Gender .....	11-24
Table 11-22.	Amount (as consumed) of Meat Consumed by Adults Grouped by Frequency of Eatings ...	11-24
Table 11-23.	Quantity (as consumed) of Meat, Poultry, and Dairy Products Consumed Per Eating Occasion and the Percentage of Individuals Using These Foods in Three Days .....	11-25
Table 11-24.	Percentage Lipid Content (Expressed as Percentages of 100 Grams of Edible Portions) of Selected Meat and Dairy Products .....	11-26
Table 11-25.	Fat Content of Meat Products .....	11-27
Table 11-26.	Fat Intake, Contribution of Various Food Groups to Fat Intake, and Percentage of the Population in Various Meat Eater Groups of the U.S. Population .....	11-28
Table 11-27.	Mean Total Daily Dietary Fat Intake (g/day) Grouped by Age and Gender .....	11-28
Table 11-28.	Percentage Mean Moisture Content (Expressed as Percentages of 100 Grams of Edible Portions) .....	11-29
Table 11-29.	Summary of Meat, Poultry, and Dairy Intake Studies .....	11-30
Table 11-30.	Summary of Recommended Values for Per Capita Intake of Meat and Dairy Products and Serving Size .....	11-31
Table 11-31.	Confidence in Meats and Dairy Products Intake Recommendations .....	11-32
Table 12-1.	Per Capita Intake of Total Grains Including Mixtures (g/kg-day as consumed) .....	12-6
Table 12-2.	Per Capita Intake of Breads (g/kg-day as consumed) .....	12-7
Table 12-3.	Per Capita Intake of Sweets (g/kg-day as consumed) .....	12-8
Table 12-4.	Per Capita Intake of Snacks Containing Grain (g/kg-day as consumed) .....	12-9
Table 12-5.	Per Capita Intake of Breakfast Foods (g/kg-day as consumed) .....	12-10
Table 12-6.	Per Capita Intake of Pasta (g/kg-day as consumed) .....	12-11
Table 12-7.	Per Capita Intake of Cooked Cereals (g/kg-day as consumed) .....	12-12
Table 12-8.	Per Capita Intake of Rice (g/kg-day as consumed) .....	12-13
Table 12-9.	Per Capita Intake of Ready-to-Eat Cereals (g/kg-day as consumed) .....	12-14
Table 12-10.	Per Capita Intake of Baby Cereals (g/kg-day as consumed) .....	12-15
Table 12-11.	Mean Daily Intakes of Grains Per Individual in a Day for USDA 1977-78, 87-88, 89-91, 94, and 95 Surveys .....	12-16
Table 12-12.	Mean Per Capita Intake Rates for Grains Based on All Sex/Age/Demographic Subgroups .....	12-16
Table 12-13.	Mean Grain Intake Per Individual in a Day by Sex and Age (g/day as consumed) for 1977-1978 .....	12-17
Table 12-14.	Mean Grain Intakes Per Individual in a Day by Sex and Age (g/day as consumed) for 1987-1988 .....	12-17
Table 12-15.	Mean Grain Intakes Per Individual in a Day by Sex and Age (g/day as consumed) for 1994 and 1995 .....	12-18
Table 12-16.	Mean and Standard Error for the Daily Per Capita Intake of Grains, by Age (g/day as consumed) .....	12-18
Table 12-17.	Mean and Standard Error for the Daily Intake of Grains, by Region (g/day as consumed) .....	12-19

## LIST OF TABLES (continued)

Page No.

Table 12-18.	Consumption of Grains (g dry weight/day) for Different Age Groups and Estimated Lifetime Average Daily Food Intakes for a U.S. Citizen (averaged across sex) Calculated from the FDA Diet Data . . . . .	12-19
Table 12-19.	Per Capita Consumption of Flour and Cereal Products in 1991 . . . . .	12-20
Table 12-20.	Quantity (as consumed) of Grain Products Consumed Per Eating Occasion and the Percentage of Individuals Using These Foods in Three Days . . . . .	12-20
Table 12-21.	Mean Moisture Content of Selected Grains Expressed as Percentages of Edible Portions . . .	12-21
Table 12-22.	Summary of Grain Intake Studies . . . . .	12-22
Table 12-23.	Summary of Recommended Values for Per Capita Intake of Grain Products . . . . .	12-22
Table 12-24.	Confidence in Grain Products Intake Recommendation . . . . .	12-23
Table 12A-1.	Food Codes and Definitions Used in the Analysis of the 1989-91 USDA CSFII Grains Data . . . . .	12A-3
Table 13-1.	1986 Vegetable Gardening by Demographic Factors . . . . .	13-1
Table 13-2.	Percentage of Gardening Households Growing Different Vegetables in 1986 . . . . .	13-1
Table 13-3.	Sub-category Codes and Definitions . . . . .	13-4
Table 13-4.	Weighted and Unweighted Number of Observations (Individuals) for NFCS Data Used in Analysis of Food Intake . . . . .	13-6
Table 13-5.	Percent Weight Losses from Preparation of Various Meats . . . . .	13-8
Table 13-6.	Percent Weight Losses from Preparation of Various Fruits . . . . .	13-8
Table 13-7.	Percent Weight Losses from Preparation of Various Vegetables . . . . .	13-9
Table 13-8.	Consumer Only Intake of Homegrown Fruits (g/kg-day) - All Regions Combined . . . . .	13-12
Table 13-9.	Consumer Only Intake of Homegrown Fruits (g/kg-day) - Northeast . . . . .	13-13
Table 13-10.	Consumer Only Intake of Homegrown Fruits (g/kg-day) - Midwest . . . . .	13-13
Table 13-11.	Consumer Only Intake of Homegrown Fruits (g/kg-day) - South . . . . .	13-14
Table 13-12.	Consumer Only Intake of Homegrown Fruits (g/kg-day) - West . . . . .	13-14
Table 13-13.	Consumer Only Intake of Homegrown Vegetables (g/kg-day) - All Regions Combined . . .	13-15
Table 13-14.	Consumer Only Intake of Homegrown Vegetables (g/kg-day) - Northeast . . . . .	13-16
Table 13-15.	Consumer Only Intake of Homegrown Vegetables (g/kg-day) - Midwest . . . . .	13-16
Table 13-16.	Consumer Only Intake of Homegrown Vegetables (g/kg-day) - South . . . . .	13-17
Table 13-17.	Consumer Only Intake of Homegrown Vegetables (g/kg-day) - West . . . . .	13-17
Table 13-18.	Consumer Only Intake of Home Produced Meats (g/kg-day) - All Regions Combined . . . .	13-18
Table 13-19.	Consumer Only Intake of Home Produced Meats (g/kg-day) - Northeast . . . . .	13-19
Table 13-20.	Consumer Only Intake of Home Produced Meats (g/kg-day) - Midwest . . . . .	13-19
Table 13-21.	Consumer Only Intake of Home Produced Meats (g/kg-day) - South . . . . .	13-20
Table 13-22.	Consumer Only Intake of Home Produced Meats (g/kg-day) - West . . . . .	13-20
Table 13-23.	Consumer Only Intake of Home Caught Fish (g/kg-day) - All Regions Combined . . . . .	13-21
Table 13-24.	Consumer Only Intake of Home Caught Fish (g/kg-day) - Northeast . . . . .	13-22
Table 13-25.	Consumer Only Intake of Home Caught Fish (g/kg-day) - Midwest . . . . .	13-22
Table 13-26.	Consumer Only Intake of Home Caught Fish (g/kg-day) - South . . . . .	13-23
Table 13-27.	Consumer Only Intake of Home Caught Fish (g/kg-day) - West . . . . .	13-23
Table 13-28.	Consumer Only Intake of Home Produced Dairy (g/kg-day) - All Regions . . . . .	13-24
Table 13-29.	Consumer Only Intake of Home Produced Dairy (g/kg-day) - Northeast . . . . .	13-25
Table 13-30.	Consumer Only Intake of Home Produced Dairy (g/kg-day) - Midwest . . . . .	13-25

**LIST OF TABLES (continued)**Page No.

Table 13-31.	Consumer Only Intake of Home Produced Dairy (g/kg-day) - South	13-26
Table 13-32.	Consumer Only Intake of Home Produced Dairy (g/kg-day) - West	13-26
Table 13-33.	Seasonally Adjusted Consumer Only Homegrown Intake (g/kg-day)	13-27
Table 13-34.	Consumer Only Intake of Homegrown Apples (g/kg-day)	13-28
Table 13-35.	Consumer Only Intake of Homegrown Asparagus (g/kg-day)	13-29
Table 13-36.	Consumer Only Intake of Home Produced Beef (g/kg-day)	13-30
Table 13-37.	Consumer Only Intake of Homegrown Beets (g/kg-day)	13-31
Table 13-38.	Consumer Only Intake of Homegrown Broccoli (g/kg-day)	13-32
Table 13-39.	Consumer Only Intake of Homegrown Cabbage (g/kg-day)	13-33
Table 13-40.	Consumer Only Intake of Homegrown Carrots (g/kg-day)	13-34
Table 13-41.	Consumer Only Intake of Homegrown Corn (g/kg-day)	13-35
Table 13-42.	Consumer Only Intake of Homegrown Cucumbers (g/kg-day)	13-36
Table 13-43.	Consumer Only Intake of Home Produced Eggs (g/kg-day)	13-37
Table 13-44.	Consumer Only Intake of Home Produced Game (g/kg-day)	13-38
Table 13-45.	Consumer Only Intake of Home Produced Lettuce (g/kg-day)	13-39
Table 13-46.	Consumer Only Intake of Home Produced Lima Beans (g/kg-day)	13-40
Table 13-47.	Consumer Only Intake of Homegrown Okra (g/kg-day)	13-41
Table 13-48.	Consumer Only Intake of Homegrown Onions (g/kg-day)	13-42
Table 13-49.	Consumer Only Intake of Homegrown Other Berries (g/kg-day)	13-43
Table 13-50.	Consumer Only Intake of Homegrown Peaches (g/kg-day)	13-44
Table 13-51.	Consumer Only Intake of Homegrown Pears (g/kg-day)	13-45
Table 13-52.	Consumer Only Intake of Homegrown Peas (g/kg-day)	13-46
Table 13-53.	Consumer Only Intake of Homegrown Peppers (g/kg-day)	13-47
Table 13-54.	Consumer Only Intake of Home Produced Pork (g/kg-day)	13-48
Table 13-55.	Consumer Only Intake of Home Produced Poultry (g/kg-day)	13-49
Table 13-56.	Consumer Only Intake of Homegrown Pumpkins (g/kg-day)	13-50
Table 13-57.	Consumer Only Intake of Homegrown Snap Beans (g/kg-day)	13-51
Table 13-58.	Consumer Only Intake of Homegrown Strawberries (g/kg-day)	13-52
Table 13-59.	Consumer Only Intake of Homegrown Tomatoes (g/kg-day)	13-53
Table 13-60.	Consumer Only Intake of Homegrown White Potatoes (g/kg-day)	13-54
Table 13-61.	Consumer Only Intake of Homegrown Exposed Fruit (g/kg-day)	13-55
Table 13-62.	Consumer Only Intake of Homegrown Protected Fruits (g/kg-day)	13-56
Table 13-63.	Consumer Only Intake of Homegrown Exposed Vegetables (g/kg-day)	13-57
Table 13-64.	Consumer Only Intake of Homegrown Protected Vegetables (g/kg-day)	13-58
Table 13-65.	Consumer Only Intake of Homegrown Root Vegetables (g/kg-day)	13-59
Table 13-66.	Consumer Only Intake of Homegrown Dark Green Vegetables (g/kg-day)	13-60
Table 13-67.	Consumer Only Intake of Homegrown Deep Yellow Vegetables (g/kg-day)	13-61
Table 13-68.	Consumer Only Intake of Homegrown Other Vegetables (g/kg-day)	13-62
Table 13-69.	Consumer Only Intake of Homegrown Citrus (g/kg-day)	13-63
Table 13-70.	Consumer Only Intake of Homegrown Other Fruit (g/kg-day)	13-64
Table 13-71.	Fraction of Food Intake that is Home Produced	13-65
Table 13-72.	Confidence in Homegrown Food Consumption Recommendations	13-67
Table 13A-1.	Food Codes and Definitions Used in Analysis of the 1987-88 USDA NFCS Data	13A-3

## LIST OF TABLES (continued)

Page No.

Table 14-1.	Daily Intakes of Breast Milk . . . . .	14-2
Table 14-2.	Breast Milk Intake for Infants Aged 1 to 6 Months . . . . .	14-2
Table 14-3.	Breast Milk Intake Among Exclusively Breast-fed Infants During the First 4 Months of Life . . . . .	14-3
Table 14-4.	Breat Milk Intake During a 24-Hour Period . . . . .	14-3
Table 14-5.	Breast Milk Intake Estimated by the DARLING Study . . . . .	14-4
Table 14-6.	Milk Intake for Bottle- and Breast-fed Infants by Age Group . . . . .	14-4
Table 14-7.	Milk Intake for Boys and Girls . . . . .	14-4
Table 14-8.	Intake of Breast Milk and Formula . . . . .	14-5
Table 14-9.	Lipid Content of Human Milk and Estimated Lipid Intake Among Exclusively Breast-fed Infants	14-6
Table 14-10.	Predicted Lipid Intakes for Breast-fed Infants Under 12 Months of Age . . . . .	14-6
Table 14-11.	Number of Meals Per Day . . . . .	14-7
Table 14-12.	Percentage of Mothers Breast-feeding Newborn Infants in the Hospital and Infants at 5 or 6 Months of Age in the United States in 1989, by Ethnic Background and Selected Demographic Variables . . . . .	14-10
Table 14-13.	Breast Milk Intake Studies . . . . .	14-11
Table 14-14.	Confidence in Breast Milk Intake Recommendations . . . . .	14-13
Table 14-15.	Breast Milk Intake Rates Derived From Key Studies . . . . .	14-14
Table 14-16.	Summary of Recommended Breast Milk and Lipid Intake Rates . . . . .	14-15



**LIST OF FIGURES**Page No.**VOLUME II**

Figure 10-1.	Seasonal Fish Consumption: Wisconsin Chippewa, 1990 .....	10-73
Figure 10-2.	Peak Fish Consumption: Wisconsin Chippewa, 1990 .....	10-73

**EPA/600/P-95-002Fa**  
**August 1997**

**VOLUME III - ACTIVITY FACTORS**

**EXPOSURE FACTORS HANDBOOK**

Update to Exposure Factors Handbook  
EPA/600/8-89/043 - May 1989

Office of Research and Development  
National Center for Environmental Assessment  
U.S. Environmental Protection Agency  
Washington, DC 20460

## **DISCLAIMER**

This document has been reviewed in accordance with U.S. Environmental Protection Agency policy and approved for publication. Mention of trade names or commercial products does not constitute endorsement or recommendation for use.

**CONTENTS (continued)**Page No.**VOLUME III**

15.	ACTIVITY FACTORS .....	15-1
15.1.	ACTIVITY PATTERNS .....	15-1
15.1.1.	Key Activity Pattern Studies .....	15-1
15.1.2.	Relevant Activity Pattern Studies .....	15-7
15.2.	OCCUPATIONAL MOBILITY .....	15-11
15.2.1.	Background .....	15-11
15.2.2.	Key Occupational Mobility Studies .....	15-11
15.3.	POPULATION MOBILITY .....	15-12
15.3.1.	Background .....	15-12
15.3.2.	Key Population Mobility Studies .....	15-13
15.3.3.	Relevant Population Mobility Studies .....	15-15
15.4.	RECOMMENDATIONS .....	15-15
15.4.1.	Recommendations for Activity Patterns .....	15-15
15.4.2.	Recommendations: Occupational Mobility .....	15-17
15.4.3.	Recommendations: Population Mobility .....	15-17
15.4.4.	Summary of Recommended Activity Factors .....	15-18
15.5.	REFERENCES FOR CHAPTER 15 .....	15-18
APPENDIX 15A	.....	15A-1
APPENDIX 15B	.....	15B-1
16.	CONSUMER PRODUCTS .....	16-1
16.1.	BACKGROUND .....	16-1
16.2.	KEY CONSUMER PRODUCTS USE STUDIES .....	16-1
16.3.	RELEVANT CONSUMER PRODUCTS USE STUDY .....	16-4
16.4.	RECOMMENDATIONS .....	16-5
16.5.	REFERENCES FOR CHAPTER 16 .....	16-5
APPENDIX 16A	.....	16A-1
17.	RESIDENTIAL BUILDING CHARACTERISTICS .....	17-1
17.1.	INTRODUCTION .....	17-1
17.2.	BUILDING CHARACTERISTICS .....	17-2
17.2.1.	Key Volumes of Residence Studies .....	17-2
17.2.2.	Volumes and Surface Areas of Rooms .....	17-4
17.2.3.	Mechanical System Configurations .....	17-6
17.2.4.	Type of Foundation .....	17-7

## CONTENTS (continued)

	<u>Page No.</u>
17.3. TRANSPORT RATES .....	17-8
17.3.1. Background .....	17-8
17.3.2. Air Exchange Rates .....	17-10
17.3.3. Infiltration Models .....	17-12
17.3.4. Deposition and Filtration .....	17-14
17.3.5. Interzonal Airflows .....	17-15
17.3.6. Water Uses .....	17-15
17.3.7. House Dust and Soil .....	17-19
17.4. SOURCES .....	17-20
17.4.1. Source Descriptions for Airborne Contaminants .....	17-20
17.4.2. Source Descriptions for Waterborne Contaminants .....	17-22
17.4.3. Soil and House Dust Sources .....	17-22
17.5. ADVANCED CONCEPTS .....	17-23
17.5.1. Uniform Mixing Assumption .....	17-23
17.5.2. Reversible Sinks .....	17-23
17.6. RECOMMENDATIONS .....	17-23
17.7. REFERENCES FOR CHAPTER 17 .....	17-24
GLOSSARY .....	G-1

## LIST OF TABLES (continued)

Page No.

### VOLUME III

Table 15-1.	Time Use Table Locator Guide .....	15-20
Table 15-2.	Mean Time Spent (minutes) Performing Major Activities Grouped by Age, Sex and Type of Day .....	15-21
Table 15-3.	Mean Time Spent (minutes) in Major Activities Grouped by Type of Day for Five Different Age Groups .....	15-22
Table 15-4.	Cumulative Frequency Distribution of Average Shower Duration for 2,550 Households ...	15-23
Table 15-5.	Mean Time Spent (minutes/day) in Ten Major Activity Categories Grouped by Total Sample and Gender for the CARB and National Studies (age 18-64 years) .....	15-24
Table 15-6.	Total Mean Time Spent at Three Major Locations Grouped by Total Sample and Gender for the CARB and National Study (ages 18-64 years) .....	15-24
Table 15-7.	Mean Time Spent at Three Locations for both CARB and National Studies (ages 12 years and older) .....	15-25
Table 15-8.	Mean Time Spent (minutes/day) in Various Microenvironments Grouped by Total Population and Gender (12 years and over) in the National and CARB Data .....	15-26
Table 15-9.	Mean Time Spent (minutes/day) in Various Microenvironments by Type of Day for the California and National Surveys (sample population ages 12 years and older) .....	15-27
Table 15-10.	Mean Time Spent (minutes/day) in Various Microenvironments by Age Groups for the National and California Surveys .....	15-28
Table 15-11.	Mean Time (minutes/day) Children Spent in Ten Major Activity Categories for All Respondents .....	15-30

**LIST OF TABLES (continued)**Page No.

Table 15-12.	Mean Time Children Spent in Ten Major Activity Categories Grouped by Age and Gender . . . . .	15-30
Table 15-13.	Mean Time Children Spent in Ten Major Activity Categories Grouped by Seasons and Regions . . . . .	15-31
Table 15-14.	Mean Time Children Spent in Six Major Location Categories for All Respondents (minutes/day) . . . . .	15-31
Table 15-15.	Mean Time Children Spent in Six Location Categories Grouped by Age and Gender . . . . .	15-32
Table 15-16.	Mean Time Children Spent in Six Location Categories Grouped by Season and Region . . . . .	15-32
Table 15-17.	Mean Time Children Spent in Proximity to Three Potential Exposures Grouped by All Respondents, Age, and Gender . . . . .	15-33
Table 15-18.	Range of Recommended Defaults for Dermal Exposure Factors . . . . .	15-33
Table 15-19.	Number of Times Taking a Shower at Specified Daily Frequencies by the Number of Respondents . . . . .	15-34
Table 15-20.	Times (minutes) Spent Taking Showers by the Number of Respondents . . . . .	15-35
Table 15-21.	Number of Minutes Spent Taking a Shower (minutes/shower) . . . . .	15-36
Table 15-22.	Time (minutes) Spent in the Shower Room Immediately After Showering by the Number of Respondents . . . . .	15-37
Table 15-23.	Number of Minutes Spent in the Shower Room Immediately After Showering (minutes/shower) . . . . .	15-38
Table 15-24.	Number of Baths Given or Taken in One Day by Number of Respondents . . . . .	15-39
Table 15-25.	Total Time Spent Taking or Giving a Bath by the Number of Respondents . . . . .	15-40
Table 15-26.	Number of Minutes Spent Giving and Taking the Bath(s) (minutes/bath) . . . . .	15-41
Table 15-27.	Time Spent in the Bathroom Immediately After the Bath(s) by the Number of Respondents . . . . .	15-42
Table 15-28.	Number of Minutes Spent in the Bathroom Immediately After the Bath(s) (minutes/bath) . . . . .	15-43
Table 15-29.	Total Time Spent Altogether in the Shower or Bathtub by the Number of Respondents . . . . .	15-44
Table 15-30.	Total Number of Minutes Spent Altogether in the Shower or Bathtub (minutes/bath) . . . . .	15-45
Table 15-31.	Time Spent in the Bathroom Immediately Following a Shower or Bath by the Number of Respondents . . . . .	15-46
Table 15-32.	Number of Minutes Spent in the Bathroom Immediately Following a Shower or Bath (minutes/bath) . . . . .	15-47
Table 15-33.	Range of Number of Times Washing the Hands at Specified Daily Frequencies by the Number of Respondents . . . . .	15-48
Table 15-34.	Number of Minutes Spent (at home) Working or Being Near Food While Fried, Grilled, or Barbequed (minutes/day) . . . . .	15-49
Table 15-35.	Number of Minutes Spent (at home) Working or Being Near Open Flames Including Barbeque Flames (minutes/day) . . . . .	15-50
Table 15-36.	Number of Minutes Spent Working or Being Near Excessive Dust in the Air (minutes/day) . . . . .	15-51
Table 15-37.	Range of the Number of Times an Automobile or Motor Vehicle was Started in a Garage or Carport at Specified Daily Frequencies by the Number of Respondents . . . . .	15-52
Table 15-38.	Range of the Number of Times Motor Vehicle Was Started with Garage Door Closed at Specified Daily Frequencies by the Number of Respondents . . . . .	15-53

## LIST OF TABLES (continued)

Page No.

Table 15-39.	Number of Minutes Spent at a Gas Station or Auto Repair Shop (minutes/day) . . . . .	15-54
Table 15-40.	Number of Minutes Spent at Home While the Windows Were Left Open (minutes/day) . . . . .	15-55
Table 15-41.	Number of Minutes the Outside Door Was Left Open While at Home (minutes/day) . . . . .	15-56
Table 15-42.	Number of Times an Outside Door Was Opened in the Home at Specified Daily Frequencies by the Number of Respondents . . . . .	15-57
Table 15-43.	Number of Minutes Spent Running, Walking, or Standing Alongside a Road with Heavy Traffic (minutes/day) . . . . .	15-58
Table 15-44.	Number of Minutes Spent in a Car, Van, Truck, or Bus in Heavy Traffic (minutes/day) . . . . .	15-59
Table 15-45.	Number of Minutes Spent in a Parking Garage or Indoor Parking Lot (minutes/day) . . . . .	15-60
Table 15-46.	Number of Minutes Spent Walking Outside to a Car in the Driveway or Outside Parking Areas (minutes/day) . . . . .	15-61
Table 15-47.	Number of Minutes Spent Running or Walking Outside Other Than to the Car (minutes/day) . . . . .	15-62
Table 15-48.	Number of Hours Spent Working for Pay (hours/week) . . . . .	15-63
Table 15-49.	Number of Hours Spent Working for Pay Between 6PM and 6AM (hours/week) . . . . .	15-64
Table 15-50.	Number of Hours Worked in a Week That Was Outdoors (hours/week) . . . . .	15-65
Table 15-51.	Number of Times Floors Were Swept or Vacuumed at Specified Frequencies by the Number of Respondents . . . . .	15-66
Table 15-52.	Number of Days Since the Floor Area in the Home Was Swept or Vacuumed by the Number of Respondents . . . . .	15-67
Table 15-53.	Number of Loads of Laundry Washed in a Washing Machine at Home by the Number of Respondents . . . . .	15-68
Table 15-54.	Number of Times Using a Dishwasher at Specified Frequencies by the Number of Respondents . . . . .	15-69
Table 15-55.	Number of Times Washing Dishes by Hand at Specified Frequencies by the Number of Respondents . . . . .	15-70
Table 15-56.	Number of Times for Washing Clothes in a Washing Machine at Specified Frequencies by the Number of Respondents . . . . .	15-71
Table 15-57.	Number of Minutes Spent Playing on Sand or Gravel in a Day by the Number of Respondents . . . . .	15-72
Table 15-58.	Number of Minutes Spent Playing in Sand or Gravel (minutes/day) . . . . .	15-73
Table 15-59.	Number of Minutes Spent Playing in Outdoors on Sand, Gravel, Dirt, or Grass When Fill Dirt Was Present by the Number of Respondents . . . . .	15-74
Table 15-60.	Number of Minutes Spent Playing on Sand, Gravel, Dirt, or Grass When Fill Dirt Was Present (minutes/day) . . . . .	15-75
Table 15-61.	Range of the Time Spent Working in a Garden or Other Circumstances in a Month by the Number of Respondents . . . . .	15-76
Table 15-62.	Number of Hours Spent Working with Soil in a Garden or Other Circumstances Working (hours/month) . . . . .	15-77
Table 15-63.	Range of Number of Minutes Spent Playing on Grass in a Day by the Number of Respondents . . . . .	15-78
Table 15-64.	Number of Minutes Spent Playing on Grass (minutes/day) . . . . .	15-79



**LIST OF TABLES (continued)**Page No.

Table 15-65.	Number of Times Swimming in a Month in Freshwater Swimming Pool by the Number of Respondents . . . . .	15-80
Table 15-66.	Range of the Average Amount of Time Actually Spent in the Water by Swimmers by the Number of Respondents . . . . .	15-82
Table 15-67.	Number of Minutes Spent Swimming in a Month in Freshwater Swimming Pool (minutes/month) . . . . .	15-83
Table 15-68.	Statistics for 24-Hour Cumulative Number of Minutes Spent Working in a Main Job . . . . .	15-84
Table 15-69.	Statistics for 24-Hour Cumulative Number of Minutes Spent in Food Preparation . . . . .	15-85
Table 15-70.	Statistics for 24-Hour Cumulative Number of Minutes Spent in Food Cleanup . . . . .	15-86
Table 15-71.	Statistics for 24-Hour Cumulative Number of Minutes Spent Cleaning House . . . . .	15-87
Table 15-72.	Statistics for 24-Hour Cumulative Number of Minutes Spent in Outdoor Cleaning . . . . .	15-88
Table 15-73.	Statistics for 24-Hour Cumulative Number of Minutes Spent in Clothes Care . . . . .	15-89
Table 15-74.	Statistics for 24-Hour Cumulative Number of Minutes Spent in Car Repair/Maintenance . . . . .	15-90
Table 15-75.	Statistics for 24-Hour Cumulative Number of Minutes Spent in Other Repairs . . . . .	15-91
Table 15-76.	Statistics for 24-Hour Cumulative Number of Minutes Spent in Plant Care . . . . .	15-92
Table 15-77.	Statistics for 24-Hour Cumulative Number of Minutes Spent in Animal Care . . . . .	15-93
Table 15-78.	Statistics for 24-Hour Cumulative Number of Minutes Spent in Other Household Work . . . . .	15-94
Table 15-79.	Statistics for 24-Hour Cumulative Number of Minutes Spent in Indoor Playing . . . . .	15-95
Table 15-80.	Statistics for 24-Hour Cumulative Number of Minutes Spent in Outdoor Playing . . . . .	15-96
Table 15-81.	Statistics for 24-Hour Cumulative Number of Minutes Spent for Car Repair Services . . . . .	15-97
Table 15-82.	Statistics for 24-Hour Cumulative Number of Minutes Spent Washing, etc. . . . .	15-98
Table 15-83.	Statistics for 24-Hour Cumulative Number of Minutes Spent Sleeping/Napping . . . . .	15-99
Table 15-84.	Statistics for 24-Hour Cumulative Number of Minutes Spent Attending Full Time School . . . . .	15-100
Table 15-85.	Statistics for 24-Hour Cumulative Number of Minutes Spent in Active Sports . . . . .	15-101
Table 15-86.	Statistics for 24-Hour Cumulative Number of Minutes Spent in Outdoor Recreation . . . . .	15-102
Table 15-87.	Statistics for 24-Hour Cumulative Number of Minutes Spent in Exercise . . . . .	15-103
Table 15-88.	Statistics for 24-Hour Cumulative Number of Minutes Spent in Food Preparation . . . . .	15-104
Table 15-89.	Statistics for 24-Hour Cumulative Number of Minutes Spent Doing Dishes/Laundry . . . . .	15-105
Table 15-90.	Statistics for 24-Hour Cumulative Number of Minutes Spent in Housekeeping . . . . .	15-106
Table 15-91.	Statistics for 24-Hour Cumulative Number of Minutes Spent in Bathing . . . . .	15-107
Table 15-92.	Statistics for 24-Hour Cumulative Number of Minutes Spent in Yardwork/Maintenance . . . . .	15-108
Table 15-93.	Statistics for 24-Hour Cumulative Number of Minutes Spent in Sports/Exercise . . . . .	15-109
Table 15-94.	Statistics for 24-Hour Cumulative Number of Minutes Eating or Drinking . . . . .	15-110
Table 15-95.	Statistics for 24-Hour Cumulative Number of Minutes Spent Indoors at an Auto Repair Shop/Gas Station . . . . .	15-111
Table 15-96.	Statistics for 24-Hour Cumulative Number of Minutes Spent Indoors at a Gym/Health Club . . . . .	15-112
Table 15-97.	Statistics for 24-Hour Cumulative Number of Minutes Spent Indoors at the Laundromat . . . . .	15-113
Table 15-98.	Statistics for 24-Hour Cumulative Number of Minutes Spent Indoors at Work (non-specific) . . . . .	15-114
Table 15-99.	Statistics for 24-Hour Cumulative Number of Minutes Spent Indoors at the Dry Cleaners . . . . .	15-115

## LIST OF TABLES (continued)

	<u>Page No.</u>
Table 15-100.	Statistics for 24-Hour Cumulative Number of Minutes Spent Indoors at a Bar/Nightclub/Bowling Alley . . . . . 15-116
Table 15-101.	Statistics for 24-Hour Cumulative Number of Minutes Spent Indoors at a Restaurant . . . . . 15-117
Table 15-102.	Statistics for 24-Hour Cumulative Number of Minutes Spent Indoors at School . . . . . 15-118
Table 15-103.	Statistics for 24-Hour Cumulative Number of Minutes Spent Indoors at a Plant/Factory/Warehouse . . . . . 15-119
Table 15-104.	Statistics for 24-Hour Cumulative Number of Minutes Spent Outdoors on a Sidewalk, Street, or in the Neighborhood . . . . . 15-120
Table 15-105.	Statistics for 24-Hour Cumulative Number of Minutes Spent Outdoors in a Parking Lot . . . . . 15-121
Table 15-106.	Statistics for 24-Hour Cumulative Number of Minutes Spent Outdoors at a Service Station or Gas Station . . . . . 15-122
Table 15-107.	Statistics for 24-Hour Cumulative Number of Minutes Spent Outdoors at a Construction Site . . . . . 15-123
Table 15-108.	Statistics for 24-Hour Cumulative Number of Minutes Spent Outdoors on School Grounds/Playground . . . . . 15-124
Table 15-109.	Statistics for 24-Hour Cumulative Number of Minutes Spent Outdoors at a Park/Golf Course . . . . . 15-125
Table 15-110.	Statistics for 24-Hour Cumulative Number of Minutes Spent Outdoors at a Pool/River/Lake . . . . . 15-126
Table 15-111.	Statistics for 24-Hour Cumulative Number of Minutes Spent Outdoors at a Restaurant/Picnic . . . . . 15-127
Table 15-112.	Statistics for 24-Hour Cumulative Number of Minutes Spent Outdoors at a Farm . . . . . 15-128
Table 15-113.	Statistics for 24-Hour Cumulative Number of Minutes Spent at Home in the Kitchen . . . . . 15-129
Table 15-114.	Statistics for 24-Hour Cumulative Number of Minutes Spent in the Bathroom . . . . . 15-130
Table 15-115.	Statistics for 24-Hour Cumulative Number of Minutes Spent at Home in the Bedroom . . . . . 15-131
Table 15-116.	Statistics for 24-Hour Cumulative Number of Minutes Spent at Home in the Garage . . . . . 15-132
Table 15-117.	Statistics for 24-Hour Cumulative Number of Minutes Spent in the Basement . . . . . 15-133
Table 15-118.	Statistics for 24-Hour Cumulative Number of Minutes Spent at Home in the Utility Room or Laundry Room . . . . . 15-134
Table 15-119.	Statistics for 24-Hour Cumulative Number of Minutes Spent at Home in the Outdoor Pool or Spa . . . . . 15-135
Table 15-120.	Statistics for 24-Hour Cumulative Number of Minutes Spent at Home in the Yard or Other Areas Outside the House . . . . . 15-136
Table 15-121.	Statistics for 24-Hour Cumulative Number of Minutes Spent Traveling in a Car . . . . . 15-137
Table 15-122.	Statistics for 24-Hour Cumulative Number of Minutes Spent Traveling in a Truck (Pick-up/Van) . . . . . 15-138
Table 15-123.	Statistics for 24-Hour Cumulative Number of Minutes Spent Traveling on a Motorcycle, Moped, or Scooter . . . . . 15-139
Table 15-124.	Statistics for 24-Hour Cumulative Number of Minutes Spent Traveling in Other Trucks . . . . . 15-140
Table 15-125.	Statistics for 24-Hour Cumulative Number of Minutes Spent Traveling on a Bus . . . . . 15-141
Table 15-126.	Statistics for 24-Hour Cumulative Number of Minutes Spent Walking . . . . . 15-142
Table 15-127.	Statistics for 24-Hour Cumulative Number of Minutes Spent Traveling on a Bicycle/Skateboard/Rollerskate . . . . . 15-143

**LIST OF TABLES (continued)**Page No.

Table 15-128.	Statistics for 24-Hour Cumulative Number of Minutes Spent Waiting on a Bus, Train etc., Stop . . . . .	15-144
Table 15-129.	Statistics for 24-Hour Cumulative Number of Minutes Spent Traveling on a Train/Subway/Rapid Transit . . . . .	15-145
Table 15-130.	Statistics for 24-Hour Cumulative Number of Minutes Spent Traveling on an Airplane . . .	15-146
Table 15-131.	Statistics for 24-Hour Cumulative Number of Minutes Spent Indoors in a Residence (all rooms) . . . . .	15-147
Table 15-132.	Statistics for 24-Hour Cumulative Number of Minutes Spent Outdoors (outside the residence) . . . . .	15-148
Table 15-133.	Statistics for 24-Hour Cumulative Number of Minutes Spent Traveling Inside a Vehicle . . . . .	15-149
Table 15-134.	Statistics for 24-Hour Cumulative Number of Minutes Spent Outdoors Near a Vehicle . . .	15-150
Table 15-135.	Statistics for 24-Hour Cumulative Number of Minutes Spent Outdoors Other Than Near a Residence or Vehicle Such as Parks, Golf Courses, or Farms . . . . .	15-151
Table 15-136.	Statistics for 24-Hour Cumulative Number of Minutes Spent in an Office or Factory . . . .	15-152
Table 15-137.	Statistics for 24-Hour Cumulative Number of Minutes Spent in Malls, Grocery Stores, or Other Stores . . . . .	15-153
Table 15-138.	Statistics for 24-Hour Cumulative Number of Minutes Spent in Schools, Churches, Hospitals, and Public Buildings . . . . .	15-154
Table 15-139.	Statistics for 24-Hour Cumulative Number of Minutes Spent in Bars/Nightclubs, Bowling Alleys, and Restaurants . . . . .	15-155
Table 15-140.	Statistics for 24-Hour Cumulative Number of Minutes Spent in Other Outdoors Such as Auto Repair Shops, Laundromats, Gyms, and at Work (non-specific) . . . . .	15-156
Table 15-141.	Statistics for 24-Hour Cumulative Number of Minutes Spent with Smokers Present . . . . .	15-157
Table 15-142.	Range of Time (minutes) Spent Smoking Based on the Number of Respondents . . . . .	15-158
Table 15-143.	Number of Minutes Spent Smoking (minutes/day) . . . . .	15-160
Table 15-144.	Range of Time Spent Smoking Cigars or Pipe Tobacco by the Number of Respondents . . .	15-161
Table 15-145.	Number of Minutes Spent Smoking Cigars or Pipe Tobacco (minutes/day) . . . . .	15-162
Table 15-146.	Range of Numbers of Cigarettes Smoked Based on the Number of Respondents . . . . .	15-163
Table 15-147.	Range of Numbers of Cigarettes Smoked by Other People Based on Number of Respondents . . . . .	15-164
Table 15-148.	Range of Numbers of Cigarettes Smoked While at Home Based on the Number of Respondents . . . . .	15-165
Table 15-149.	Differences in Time Use (hours/week) Grouped by Sex, Employment Status, and Marital Status for the Surveys Conducted in 1965 and 1975 . . . . .	15-166
Table 15-150.	Time Use (hours/week) Differences by Age for the Surveys Conducted in 1965 and 1975 . . . . .	15-167
Table 15-151.	Time Use (hours/week) Differences by Education for the Surveys Conducted in 1965 and 1975 . . . . .	15-168
Table 15-152.	Time Use (hours/week) Differences by Race for the Surveys Conducted in 1965 and 1975 . . . . .	15-169
Table 15-153.	Mean Time Spent (hours/week) in Ten Major Activity Categories Grouped by Regions . . .	15-169
Table 15-154.	Total Mean Time Spent (minutes/day) in Ten Major Activity Categories Grouped by Type of Day . . . . .	15-170

## LIST OF TABLES (continued)

	<u>Page No.</u>
Table 15-155.	Mean Time Spent (minutes/day) in Ten Major Activity Categories During Four Waves of Interviews . . . . . 15-170
Table 15-156.	Mean Time Spent (hours/week) in Ten Major Activity Categories Grouped by Gender . . . 15-171
Table 15-157.	Percent Responses of Children's "Play" (activities) Locations in Maryvale, Arizona . . . . . 15-171
Table 15-158.	Occupational Tenure of Employed Individuals by Age and Sex . . . . . 15-172
Table 15-159.	Occupational Tenure for Employed Individuals Grouped by Sex and Race . . . . . 15-172
Table 15-160.	Occupational Tenure for Employed Individuals Grouped by Sex and Employment Status . . . . . 15-172
Table 15-161.	Occupational Tenure of Employed Individuals Grouped by Major Occupational Groups and Age . . . . . 15-173
Table 15-162.	Voluntary Occupational Mobility Rates for Workers Age 16 Years and Older . . . . . 15-173
Table 15-163.	Values and Their Standard Errors for Average Total Residence Time, T, for Each Group in Survey . . . . . 15-174
Table 15-164.	Total Residence Time, t (years), Corresponding to Selected Values of R(t) by Housing Category . . . . . 15-174
Table 15-165.	Residence Time of Owner/Renter Occupied Units . . . . . 15-175
Table 15-166.	Percent of Householders Living in Houses for Specified Ranges of Time . . . . . 15-175
Table 15-167.	Descriptive Statistics for Residential Occupancy Period . . . . . 15-176
Table 15-168.	Descriptive Statistics for Both Genders by Current Age . . . . . 15-176
Table 15-169.	Summary of Residence Time of Recent Home Buyers (1993) . . . . . 15-177
Table 15-170.	Tenure in Previous Home (Percentage Distribution) . . . . . 15-177
Table 15-171.	Number of Miles Moved (Percentage Distribution) . . . . . 15-177
Table 15-172.	Confidence in Activity Patterns Recommendations . . . . . 15-178
Table 15-173.	Confidence in Occupational Mobility Recommendations . . . . . 15-185
Table 15-174.	Recommendations for Population Mobility . . . . . 15-188
Table 15-175.	Confidence in Population Mobility Recommendations . . . . . 15-188
Table 15-176.	Summary of Recommended Values for Activity Factors . . . . . 15-187
Table 15A-1.	Activity Codes and Descriptors Used for Adult Time Diaries . . . . . 15A-3
Table 15A-2.	Differences in Average Time Spent in Different Activities Between California and National Studies (minutes per day for age 18-64 years) . . . . . 15A-17
Table 15A-3.	Time Spent in Various Microenvironments . . . . . 15A-19
Table 15A-4.	Major Time Use Activity Categories . . . . . 15A-21
Table 15A-5.	Mean Time Spent (minutes/day) for 87 Activities Grouped by Day of the Week . . . . . 15A-22
Table 15A-6.	Weighted Mean Hours Per Week by Gender: 87 Activities and 10 Subtotals . . . . . 15A-24
Table 15A-7.	Ranking of Occupations by Median Years of Occupational Tenure . . . . . 15A-27
Table 15B-1.	Annual Geographical Mobility Rates, by Type of Movement for Selected 1-Year Periods: 1960-1992 (numbers in thousands) . . . . . 15B-3
Table 15B-2.	Mobility of the Resident Population by State: 1980 . . . . . 15B-4
Table 16-1.	Consumer Products Found in the Typical U.S. Household . . . . . 16-7
Table 16-2.	Frequency of Use for Household Solvent Products (users-only) . . . . . 16-10
Table 16-3.	Exposure Time of Use for Household Solvent Products (users-only) . . . . . 16-11
Table 16-4.	Amount of Products Used for Household Solvent Products (users-only) . . . . . 16-12
Table 16-5.	Time Exposed After Duration of Use for Household Solvent Products (users-only) . . . . . 16-13
Table 16-6.	Frequency of Use and Amount of Product Used for Adhesive Removers . . . . . 16-14

**LIST OF TABLES (continued)**

	<u>Page No.</u>
Table 16-7.	Adhesive Remover Usage by Gender . . . . . 16-14
Table 16-8.	Frequency of Use and Amount of Product Used for Spray Paint . . . . . 16-15
Table 16-9.	Spray Paint Usage by Gender . . . . . 16-15
Table 16-10.	Frequency of Use and Amount of Product Used for Paint Removers/Strippers . . . . . 16-16
Table 16-11.	Paint Stripper Usage by Gender . . . . . 16-16
Table 16-12.	Total Exposure Time of Performing Task and Product Type Used by Task for Household Cleaning Products . . . . . 16-17
Table 16-13.	Percentile Rankings for Total Exposure Time in Performing Household Tasks . . . . . 16-19
Table 16-14.	Mean Percentile Rankings for Frequency of Performing Household Tasks . . . . . 16-20
Table 16-15.	Mean and Percentile Rankings for Exposure Time Per Event of Performing Household Tasks . . . . . 16-21
Table 16-16.	Total Exposure Time for Ten Product Groups Most Frequently Used for Household Cleaning . . . . . 16-21
Table 16-17.	Total Exposure Time of Painting Activity of Interior Painters (hours) . . . . . 16-22
Table 16-18.	Exposure Time of Interior Painting Activity/Occasion (hours) and Frequency of Occasions Spent Painting Per Year . . . . . 16-22
Table 16-19.	Amount of Paint Used by Interior Painters . . . . . 16-22
Table 16-20.	Number of Respondents Using Cologne, Perfume, Aftershave or Other Fragrances at Specified Daily Frequencies . . . . . 16-23
Table 16-21.	Number of Respondents Using Any Aerosol Spray Product for Personal Care Item Such as Deodorant or Hair Spray at Specified Daily Frequencies . . . . . 16-24
Table 16-22.	Number of Minutes Spent in Activities Working with or Being Near Freshly Applied Paints (minutes/day) . . . . . 16-25
Table 16-23.	Number of Minutes Spent in Activities Working with or Near Household Cleaning Agents Such as Scouring Powders or Ammonia (minutes/day) . . . . . 16-26
Table 16-24.	Number of Minutes Spent in Activities (at home or elsewhere) Working with or Near Floorwax, Furniture Wax or Shoe Polish (minutes/day) . . . . . 16-27
Table 16-25.	Number of Minutes Spent in Activities Working with or Being Near Glue . . . . . 16-28
Table 16-26.	Number of Minutes Spent in Activities Working with or Near Solvents, Fumes or Strong Smelling Chemicals (minutes/day) . . . . . 16-29
Table 16-27.	Number of Minutes Spent in Activities Working with or Near Stain or Spot Removers (minutes/day) . . . . . 16-30
Table 16-28.	Number of Minutes Spent in Activities Working with or Near Gasoline or Diesel-powered Equipment, Besides Automobiles (minutes/day) . . . . . 16-31
Table 16-29.	Number of Minutes Spent Using Any Microwave Oven (minutes/day) . . . . . 16-32
Table 16-30.	Number of Respondents Using a Humidifier at Home . . . . . 16-33
Table 16-31.	Number of Respondents Indicating that Pesticides Were Applied by the Professional at Home to Eradicate Insects, Rodents, or Other Pests at Specified Frequencies . . . . . 16-34
Table 16-32.	Number of Respondents Reporting Pesticides Applied by the Consumer at Home to Eradicate Insects, Rodents, or Other Pests at Specified Frequencies . . . . . 16-35
Table 16-33.	Number of Minutes Spent in Activities Working with or Near Pesticides, Including Bug Sprays or Bug Strips (minutes/day) . . . . . 16-36
Table 16-34.	Amount and Frequency of Use of Various Cosmetic and Baby Products . . . . . 16-37
Table 16-35.	Summary of Consumer Products Use Studies . . . . . 16-40
Table 16A-1.	Volumes Included in 1992 Simmons Study . . . . . 16A-3

## LIST OF TABLES (continued)

	<u>Page No.</u>
Table 17-1.	Summary of Residential Volume Distributions ..... 17-3
Table 17-2.	Average Estimated Volumes of U.S. Residences, by Housing Type and Ownership ..... 17-4
Table 17-3.	Residential Volumes in Relation to Household Size and Year of Construction ..... 17-4
Table 17-4.	Dimensional Quantities for Residential Rooms ..... 17-5
Table 17-5.	Examples of Products and Materials Associated with Floor and Wall Surfaces in Residences ..... 17-6
Table 17-6.	Percent of Residences with Basement, by Census Region and EPA Region ..... 17-8
Table 17-7.	Percent of Residences with Certain Foundation Types by Census Region ..... 17-9
Table 17-8.	States Associated with EPA Regions and Census Regions ..... 17-9
Table 17-9.	Summary of Major Projects Providing Air Exchange Measurements in the PFT Database ..... 17-11
Table 17-10.	Summary Statistics for Air Exchange Rates (air changes per hour-ACH), by Region ..... 17-12
Table 17-11.	Distributions of Residential Air Exchange Rates by Climate Region and Season ..... 17-13
Table 17-12.	Deposition Rates for Indoor Particles ..... 17-15
Table 17-13.	Particle Deposition During Normal Activities ..... 17-15
Table 17-14.	In-house Water Use Rates (gcd), by Study and Type of Use ..... 17-17
Table 17-15.	Summary of Selected HUD and Power Authority Water Use Studies ..... 17-17
Table 17-16.	Showering and Bathing Water Use Characteristics ..... 17-18
Table 17-17.	Showering Characteristics for Various Types of Shower Heads ..... 17-18
Table 17-18.	Toilet Water Use Characteristics ..... 17-18
Table 17-19.	Toilet Frequency Use Characteristics ..... 17-18
Table 17-20.	Dishwasher Frequency Use Characteristics ..... 17-18
Table 17-21.	Dishwasher Water Use Characteristics ..... 17-19
Table 17-22.	Clothes Washer Frequency Use Characteristics ..... 17-19
Table 17-23.	Clothes Washer Water Use Characteristics ..... 17-19
Table 17-24.	Range of Water Uses for Clothes Washers ..... 17-19
Table 17-25.	Total Dust Loading for Carpeted Areas ..... 17-19
Table 17-26.	Particle Deposition and Resuspension During Normal Activities ..... 17-20
Table 17-27.	Dust Mass Loading After One Week Without Vacuum Cleaning ..... 17-20
Table 17-28.	Simplified Source Descriptions for Airborne Contaminants ..... 17-21
Table 17-29.	Volume of Residence Surveys ..... 17-29
Table 17-30.	Air Exchange Rates Surveys ..... 17-29
Table 17-31.	Recommendations - Residential Parameters ..... 17-30
Table 17-32.	Confidence in House Volume Recommendations ..... 17-30
Table 17-33.	Confidence in Air Exchange Rate Recommendations ..... 17-31

**LIST OF FIGURES**Page No.**VOLUME III**

Figure 15-1.	Distribution of Individuals Moving by Type of Move: 1991-92 .....	15-14
Figure 17-1.	Elements of Residential Exposure .....	17-1
Figure 17-2.	Cumulative Frequency Distributions for Residential Volumes from the PFT Data Base and the U.S. DOE's RECs .....	17-3
Figure 17-3.	Configuration for Residential Forced-air Systems .....	17-7
Figure 17-4.	Idealized Patterns of Particle Deposition Indoors .....	17-14
Figure 17-5.	Air Flows for Multiple-zone Systems .....	17-16

## PREFACE

The National Center for Environmental Assessment (NCEA) of EPA's Office of Research and Development (ORD) has prepared this handbook to address factors commonly used in exposure assessments. This handbook was first published in 1989 in response to requests from many EPA Program and Regional offices for additional guidance on how to select values for exposure factors.

Several events sparked the efforts to revise the Exposure Factors Handbook. First, since its publication in 1989, new data have become available. Second, the Risk Assessment Council issued a memorandum titled, "Guidance on Risk Characterization for Risk Managers and Risk Assessors," dated February 26, 1992, which emphasized the use of multiple descriptors of risk (i.e., measures of central tendency such as average or mean, or high end), and characterization of individual risk, population risk, important subpopulations. A new document was issued titled "Guidance for Risk Characterization," dated February 1995. This document is an update of the guidance issued with the 1992 policy. Third, EPA published the revised Guidelines for Exposure Assessment in 1992.

As part of the efforts to revise the handbook, the EPA Risk Assessment Forum sponsored a two-day peer involvement workshop which was conducted during the summer of 1993. The workshop was attended by 57 scientists from academia, consulting firms, private industry, the States, and other Federal agencies. The purpose of the workshop was to identify new data sources, to discuss adequacy of the data and the feasibility of developing statistical distributions and to establish priorities.

As a result of the peer involvement workshop, three new chapters were added to the handbook. These chapters are: Consumer Product Use, Residential Building Characteristics, and Intake of Grains. This document also provides a summary of the available data on consumption of drinking water; consumption of fruits, vegetables, beef, dairy products, grain products, and fish; breast milk intake; soil ingestion; inhalation rates; skin surface area; soil adherence; lifetime; activity patterns; and body weight.

A new draft handbook that incorporated comments from the 1993 workshop was published for peer review in June 1995. A peer review workshop was held in July 1995 to discuss comments on the draft handbook. A new draft of the handbook that addressed comments from the 1995 peer review workshop was submitted to the Science Advisory Board (SAB) for review in August 1996. An SAB workshop meeting was held December 19-20, 1996, to discuss the comments of the SAB reviewers. Comments from the SAB review have been incorporated into the current handbook.



## FOREWORD

The National Center for Environmental Assessment (NCEA) of EPA's Office of Research and Development (ORD) has five main functions: (1) providing risk assessment research, methods, and guidelines; (2) performing health and ecological assessments; (3) developing, maintaining, and transferring risk assessment information and training; (4) helping ORD set research priorities; and (5) developing and maintaining resource support systems for NCEA. The activities under each of these functions are supported by and respond to the needs of the various program offices. In relation to the first function, NCEA sponsors projects aimed at developing or refining techniques used in exposure assessments.

This handbook was first published in 1989 to provide statistical data on the various factors used in assessing exposure. This revised version of the handbook provides the up-to-date data on these exposure factors. The recommended values are based solely on our interpretations of the available data. In many situations different values may be appropriate to use in consideration of policy, precedent or other factors.

Michael A. Callahan  
Director  
National Center for Environmental Assessment  
Washington Office

## AUTHORS, CONTRIBUTORS, AND REVIEWERS

The National Center for Environmental Assessment (NCEA), Office of Research and Development was responsible for the preparation of this handbook. The original document was prepared by Versar Inc. under EPA Contract No. 68-02-4254, Work Assignment No. 189. John Schaum, of NCEA-Washington Office, served as the EPA Work Assignment Manager, providing overall direction and coordination of the production effort as well as technical assistance and guidance. Revisions, updates, and additional preparation were provided by Versar Inc. under Contract Numbers 68-D0-0101, 68-D3-0013, and 68-D5-0051. Russell Kinerson and Greg Kew have served as EPA Work Assignment Managers during previous efforts of the update process. Jackie Moya served as Work Assignment Manager for the current updated version, providing overall direction, technical assistance, and serving as contributing author.

### AUTHORS

Patricia Wood  
Linda Phillips  
Aderonke Adenuga  
Mike Koontz  
Harry Rector  
Charles Wilkes  
Maggie Wilson

### DESKTOP PUBLISHING

Susan Perry

### WORD PROCESSING

Valerie Schwartz

### GRAPHICS

Kathy Bowles  
Jennifer Baker

Exposure Assessment Division  
Versar Inc.  
Springfield, VA

### CONTRIBUTORS AND REVIEWERS

The following EPA individuals have reviewed and/or have been contributing authors of this document.

Michael Dellarco  
Robert McGaughy  
Amy Mills  
Jacqueline Moya  
Susan Perlin

Paul Pinsky  
John Schaum  
Paul White  
Amina Wilkins  
Chieh Wu

The following individuals were Science Advisory Board Reviewers:

#### Members

Dr. Joan Daisey  
Lawrence Berkley Laboratory  
Berkley, California

Dr. Paul Bailey  
Mobil Business Resources Corporation  
Paulsboro, New Jersey

Dr. Robert Hazen  
State of New Jersey Department of  
Environmental Protection and Energy  
Trenton, New Jersey

Dr. Timothy Larson  
Department of Civil Engineering  
University of Washington  
Seattle, Washington

Dr. Kai-Shen Liu  
California Department of Health Services  
Berkeley, California

Dr. Paul Liroy  
Environmental Occupational Health  
Sciences Institute  
Piscataway, New Jersey

Dr. Maria Morandi  
University of Texas School of Public Health  
Houston, Texas

Dr. Jonathan M. Samet  
The Johns Hopkins University  
Baltimore, Maryland

Mr. Ron White  
American Lung Association  
Washington, D.C.

Dr. Lauren Zeise  
California Environmental Protection Agency  
Berkeley, California

#### Federal Experts

Dr. Richard Ellis  
U.S. Department of Agriculture  
Washington, D.C.

Ms. Alanna J. Moshfegh  
U.S. Department of Agriculture  
Washington, D.C.

An earlier draft of this document was peer reviewed by a panel of experts at a peer-review workshop held in 1995. Members of the Peer Review Panel were as follows:

Edward Avol  
Department of Preventive Medicine  
School of Medicine  
University of Southern California

James Axley  
School of Architecture  
Yale University

David Burmaster  
Alceon Corporation

Steven Colome  
Integrated Environmental Services

Michael DiNovi  
Chemistry Review Branch  
U.S. Food & Drug Administration

Dennis Druck  
Environmental Scientist  
Center of Health Promotion & Preventive  
Medicine  
U.S. Army

J. Mark Fly  
Department of Forestry, Wildlife, &  
Fisheries  
University of Tennessee

Larry Gephart  
Exxon Biomedical Sciences, Inc.

Patricia Guenther  
Beltsville Human Nutrition Research Center  
U.S. Department of Agriculture

P.J. (Bert) Hakkinen  
Paper Product Development & Paper  
Technology Divisions  
The Proctor & Gamble Company

Mary Hama  
Beltsville Human Nutrition Research Center  
U.S. Department of Agriculture

Dennis Jones  
Agency for Toxic Substances & Disease Registry

John Kissel  
Department of Environmental Health  
School of Public Health & Community Medicine

Neil Klepeis  
Information Systems & Services, Inc.

Andrew Persily  
National Institute of Standards & Technologies

Barbara Petersen  
Technical Assessment Systems, Inc.

Thomas Phillips  
Research Division  
California Air Resources Board

Paul Price  
ChemRisk

John Risher  
Division of Toxicology  
The Agency for Toxic Substances & Disease Registry

John Robinson  
University of Maryland

Peter Robinson  
The Proctor & Gamble Company

P. Barry Ryan  
Department of Environmental & Occupational  
Health  
Rollins School of Public Health  
Emory University

Val Schaeffer  
U.S. Consumer Product Safety Commission

Brad Shurdut  
DowElanco

John Talbott

U.S. Department of Energy

Frances Vecchio  
Beltsville Human Nutrition Research Center  
U.S. Department of Agriculture

The following individuals within EPA have reviewed an earlier draft of this document and provided valuable comments:

---

OFFICE	REVIEWERS/CONTRIBUTORS
Office of Research and Development	Maurice Berry Jerry Blancato Elizabeth Bryan Curtis Dary Stan Durkee Manuel Gomez Wayne Marchant Sue Perlin James Quanckenboss Glen Rice Lance Wallace
Office of Emergency and Remedial Response	Jim Konz
Office of Pollution, Pesticides and Toxic Substances	Pat Kennedy Cathy Fehrenbacher
Office of Water	Denis Borum Helen Jacobs
Office of Air Quality Planning and Standards	Warren Peters
EPA Regions	Steve Ehlers - Reg. VI Maria Martinez - Reg. VI Mike Morton - Reg. VI Jeffrey Yurk - Reg. VI Youngmoo Kim - Reg. VI

---

In addition, the National Exposure Research Laboratory (NERL) of the Office of Research and Development of EPA made an important contribution to this handbook by conducting additional analyses of the National Human Activity Pattern Survey (NHAPS) data. EPA input to the NHAPS data analysis came from Karen A. Hammerstrom and Jacqueline Moya from NCEA-Washington Office; William C. Nelson from NERL-RTP, and Stephen C. Hern, Joseph V. Behar (retired), and William H. Englemann from NERL-Las Vegas.

The EPA Office of Water made an important contribution by conducting an analysis of the USDA Continuing Survey of Food Intakes by Individual (CSFII) data. They provided fish intake rates for the general population. The analysis was conducted under the direction of Helen Jacobs from the Office of Water.

Errata Sheet  
Exposure Factors Handbook, August 1997

EPA/600/P-95/002Fa,b,c

Location	Change
Volume I, Chapter 1	
Page 1-7, Table 1-2	Fish intake rate - General population <u>63</u> g/day (total fish) should be <u>53</u> g/day (total fish) Recreational freshwater <u>25</u> g/day (95th percentile) should be <u>26</u> g/day (95th percentile) Time Indoors - Residential 16.4 hrs/day should be 16.7 hrs/day
Volume I, Chapter 4	
Page 4-6, Equation 4-2	Equation should read as follows:  $S_{i,p} = \frac{((DW_f + DW_p) \times E_f) + 2E_u}{E_{soil}} - (DW_{fd} \times E_{fd})$
Volume II, Chapter 10	
Page 10-6, 1st Column, 2nd ¶	Table 10-13 should be Table 10-45
Page 10-6, 2nd Column, 4th ¶	Table 10-14 should be Table 10-46
Page 10-7, 2nd Column, 3rd ¶	Table 10-15 should be Table 10-47 Table 10-16 should be Table 10-48 Table 10-17 should be Table 10-49
Page 10-7, 2nd Column, 4th ¶	Table 10-8 should be Table 10-82
Page 10-9, 1st Column, 3rd ¶	Table 10-18 should be Table 10-50
Page 10-9, 2nd Column, 2nd ¶	Table 10-19 should be Table 10-51
Page 10-9, 2nd Column, 3rd ¶	Table 10-20 should be Table 10-52 Table 10-21 should be Table 10-53 Table 10-22 should be Table 10-54
Page 10-10, 2nd Column, 2nd ¶	Table 10-23 should be Table 10-55 Table 10-24 should be Table 10-56 Table 10-25 should be Table 10-57
Page 10-11, 2nd Column, 2nd ¶	Table 10-26 should be Table 10-58
Page 10-11, 2nd Column, 4th ¶	Table 10-27 should be Table 10-59
Page 10-12, 2nd Column, 2nd ¶	Table 10-28 should be Table 10-60

Location	Change
Page 10-13, 2nd Column, 2nd ¶	Table 10-29 should be Table 10-61
Page 10-13, 2nd Column, 3rd ¶	Table 10-30 should be Table 10-62
Page 10-14, 1st Column, 3rd & 4th ¶	Table 10-31 should be Table 10-63
Page 10-15, 1st Column, 3rd ¶	Chemrisk (1991) should be Chemrisk (1992)
Page 10-15, 1st Column, 4th ¶	Table 10-32 should be Table 10-64 Table 10-33 should be Table 10-65 Chemrisk (1991) should be Chemrisk (1992)
Page 10-15, 1st Column, 5th ¶	Table 10-34 should be Table 10-66
Page 10-15, 2nd Column, 1st ¶	Chemrisk (1991) should be Chemrisk (1992)
Page 10-16, 1st Column, 2nd ¶	Chemrisk (1991) should be Chemrisk (1992)
Page 10-16, 2nd Column, 4th ¶	Table 10-35 should be Table 10-67
Page 10-17, 2nd Column, 2nd ¶	Table 10-36 should be Table 10-68 Table 10-37 should be Table 10-69
Page 10-18, 2nd Column, 1st ¶	Table 10-38 should be Table 10-70
Page 10-19, 1st Column, 6th ¶	Table 10-39 should be Table 10-71
Page 10-21, 2nd Column, 5th ¶	Table 10-40 should be Table 10-72 Table 10-41 should be Table 10-73
Page 10-22, 1st Column, 2nd ¶	Table 10-42 should be Table 10-74
Page 10-22, 2nd Column, 3rd ¶	Table 10-43 should be Table 10-75
Page 10-23, 2nd Column, 3rd ¶	Table 10-44 should be Table 10-76 Table 10-45 should be Table 10-77
Page 10-23, 2nd Column, 4th ¶	Table 10-46 should be Table 10-78
Page 10-24, 2nd Column, 1st ¶	Table 10-47 should be Table 10-79
Page 10-24, 2nd Column, 2nd ¶	Table 10-48 should be Table 10-80
Page 10-24, 2nd Column, 3rd ¶	Table 10-48 should be Table 10-80
Page 10-24, 2nd Column, 4th ¶	Table 10-48 should be Table 10-80
Page 10-25, 2nd Column, 2nd ¶	Table 10-49 should be Table 10-81
Page 10-25, 2nd Column, 3rd ¶	6.6 g/day should be 6.0 g/day 13.5 g/day should be 14.1 g/day
Page 10-26, 1st Column, 2nd ¶	Table 10-49 should be Table 10-81 56 g/day should be 53 g/day

Location	Change
Page 10-26, 2nd Column, 1st ¶	Table 10-50 should be Table 10-82
Page 10-26, 2nd Column, 2nd ¶	Table 10-51 should be Table 10-83
Page 10-26, 2nd Column, 3rd ¶	Table 10-52 should be Table 10-84 25 g/day should be 26 g/day
Page 10-25, 2nd Column, 4th ¶	Table 10-53 should be Table 10-85
Page 10-27, 1st Column, 3rd ¶	Table 10-54 should be Table 10-86 Table 10-55 should be Table 10-87 Table 10-56 should be Table 10-88 Table 10-57 should be Table 10-89 Table 10-58 should be Table 10-90
Page 10-26, 1st Column, References	Chemrisk (1991) . . . should read: Chemrisk (1992) Consumption of freshwater fish by Maine anglers. A Technical Report. Portland, ME: Chemrisk, A Division of McLaren/Hart. Revised July 24, 1994.
Page 10-79, Table 10-81	63 (value of 42 . . .) should be 53 (value of 42 . . .) . . . by 50 percent . . . should be . . . by 25 percent . . .
Page 10-79, Table 10-84	13 (95th percentile) should be 21 (95th percentile)



1.	INTRODUCTION .....	1
1.1.	PURPOSE .....	1
1.2.	INTENDED AUDIENCE .....	1
1.3.	BACKGROUND .....	1
	1.3.1. Selection of Studies for the Handbook .....	1
	1.3.2. Using the Handbook in an Exposure Assessment .....	3
	1.3.3. Approach Used to Develop Recommendations for Exposure Factors ...	4
	1.3.4. Characterizing Variability .....	5
1.4.	GENERAL EQUATION FOR CALCULATING DOSE .....	11
1.5.	RESEARCH NEEDS .....	14
1.6.	ORGANIZATION .....	15
1.7.	REFERENCES FOR CHAPTER 1 .....	16

Chapter 1 - Introduction

1. INTRODUCTION

1.1. PURPOSE

The purpose of the Exposure Factors Handbook is to: (1) summarize data on human behaviors and characteristics which affect exposure to environmental contaminants, and (2) recommend values to use for these factors. These recommendations are not legally binding on any EPA program and should be interpreted as suggestions which program offices or individual exposure assessors can consider and modify as needed. Most of these factors are best quantified on a site or situation-specific basis. The handbook has strived to include full discussions of the issues which assessors should consider in deciding how to use these data and recommendations. The handbook is intended to serve as a support document to EPA's Guidelines for Exposure Assessment (U.S. EPA, 1992a). The Guidelines were developed to promote consistency among the various exposure assessment activities that are carried out by the various EPA program offices. This handbook assists in this goal by providing a consistent set of exposure factors to calculate dose.

- update of homegrown food intake;
- expansion of data in the dermal chapter;
- update of fish intake data;
- expansion of data for time spent at residence;
- update of body weight data;
- addition of body weight data for infants;
- update of population mobility data;
- addition of new data for average time spent in different locations and various microenvironments;
- addition of data for occupational mobility;
- addition of breast milk ingestion;
- addition of consumer product use; and
- addition of reference residence factors.

1.2. INTENDED AUDIENCE

The Exposure Factors Handbook is addressed to exposure assessors inside the Agency as well as outside, who need to obtain data on standard factors needed to calculate human exposure to toxic chemicals.

**Purpose**

- Summarize data on human behaviors and characteristics affecting exposure
- Recommend exposure factor values

1.3. BACKGROUND

This handbook is the update of an earlier version prepared in 1989. Revisions have been made in the following areas:

- addition of drinking water rates for children;
- changes in soil ingestion rates for children;
- addition of soil ingestion rates for adults;
- addition of tapwater consumption for adults and children;
- addition of mean daily intake of food class and subclass by region, age and per capita rates;
- addition of mean moisture content of selected fruits, vegetables, grains, fish, meat, and dairy products;
- addition of food intake by class in dry weight per kg of body weight per day;

Variation Among Studies

This handbook is a compilation of available data from a variety of different sources. With very few exceptions, the data presented are the analyses of the individual study authors. Since the studies included in this handbook varied in terms of their objectives, design, scope,

presentation of results, etc., the level of detail, statistics, and terminology may vary from study to study and from factor to factor. For example, some authors used geometric means to present their results, while others used arithmetic means or distributions.

Authors have sometimes used different terms to describe the same racial populations. Within the constraint of presenting the original material as accurately as

possible, EPA has made an effort to present discussions and results in a consistent manner. Further, the strengths and limitations of each study are discussed to provide the reader with a better understanding of the uncertainties associated with the values derived from the study.

1.3.1. Selection of Studies for the Handbook

Information in this handbook has been summarized from studies documented in the scientific literature and

other available sources. Studies were chosen that were seen as useful and appropriate for estimating exposure factors. The handbook contains summaries of selected studies published through August 30, 1997.

#### General Considerations

Many scientific studies were reviewed for possible inclusion in this handbook. Studies were selected based on the following considerations:

- Level of peer review: Studies were selected predominantly from the peer-reviewed literature and final government reports. Internal or interim reports were therefore avoided.
- Accessibility: Studies were preferred that the user could access in their entirety if needed.
- Reproducibility: Studies were sought that contained sufficient information so that methods could be reproduced, or at least so the details of the author's work could be accessed and evaluated.
- Focus on exposure factor of interest: Studies were chosen that directly addressed the exposure factor of interest, or addressed related factors that have significance for the factor under consideration. As an example of the latter case, a selected study contained useful ancillary information concerning fat content in fish, although it did not directly address fish consumption.
- Data pertinent to the U.S.: Studies were selected that addressed the U.S. population. Data from populations outside the U.S. were sometimes included if behavioral patterns and other characteristics of exposure were similar.
- Primary data: Studies were deemed preferable if based on primary data, but studies based on secondary sources were also included where they offered an original analysis. For example, the handbook cites studies of food consumption based on original data collected by the USDA National Food Consumption Survey.
- Current information: Studies were chosen only if they were sufficiently recent to represent current exposure conditions. This is an important consideration for those factors that change with time.
- Adequacy of data collection period: Because most users of the handbook are primarily addressing chronic exposures, studies were sought that utilized the most appropriate techniques for collecting data to characterize long-term behavior.
- Validity of approach: Studies utilizing experimental procedures or approaches that more likely or closely capture the desired measurement were selected. In general, direct exposure data collection techniques, such as direct observation, personal monitoring devices, or other known methods were preferred where available. If studies utilizing direct measurement were not available, studies were selected that rely on validated indirect measurement methods such as surrogate measures (such as heart rate for inhalation rate), and use of questionnaires. If questionnaires or surveys were used, proper design and procedures include an adequate sample size for the population under consideration, a response rate large enough to avoid biases, and avoidance of bias in the design of the instrument and interpretation of the results.
- Representativeness of the population: Studies seeking to characterize the national population, a particular region, or sub-population were selected, if appropriately representative of that population. In cases where data were limited, studies with limitations in this area were included and limitations were noted in the handbook.
- Variability in the population: Studies were sought that characterized any variability within populations.
- Minimal (or defined) bias in study design: Studies were sought that were designed with minimal bias, or at least if biases were

suspected to be present, the direction of the bias (i.e., an over or under estimate of the parameter) was either stated or apparent from the study design.

- Minimal (or defined) uncertainty in the data: Studies were sought with minimal uncertainty in the data, which was judged by evaluating all the considerations listed above. At least, studies were preferred that identified uncertainties, such as those due to inherent variability in environmental and exposure-related parameters or possible measurement error. Studies that documented Quality Assurance/Quality Control measures were preferable.

- Guidelines for Exposure Assessment (U.S. EPA 1992a);
- Dermal Exposure Assessment: Principles and Applications (U.S. EPA 1992b);
- Methodology for Assessing Health Risks Associated with Indirect Exposure to Combustor Emissions (U.S. EPA, 1990);
- Risk Assessment Guidance for Superfund (U.S. EPA, 1989);
- Estimating Exposures to Dioxin-Like Compounds (U.S. EPA, 1994);
- Superfund Exposure Assessment Manual (U.S. EPA, 1988a);
- Selection Criteria for Mathematical Models Used in Exposure Assessments (U.S. EPA 1988b);

Key versus relevant studies

Certain studies described in this handbook are designated as "key," that is, the most useful for deriving exposure factors. The recommended values for most exposure factors are based on the results of the key studies. Other studies are designated "relevant," meaning applicable or pertinent, but not necessarily the most important. This distinction was made on the strength of the attributes listed in the "General Considerations." For example, in Chapter 14 of Volume III, one set of studies is deemed to best address the attributes listed and is designated as "key." Other applicable studies, including foreign data, believed to have value to handbook users, but having fewer attributes, are designated "relevant."

**Key vs. Relevant Studies**

- Key studies used to derive recommendations
- Relevant studies included to provide

- Selection Criteria for Mathematical Models Used in Exposure Assessments (U.S. EPA 1987);
- Standard Scenarios for Estimating Exposure to Chemical Substances During Use of Consumer Products (U.S. EPA 1986a);

- Pesticide Assessment Guidelines, Subdivisions K and U (U.S. EPA, 1984, 1986b); and
- Methods for Assessing Exposure to Chemical Substances, Volumes 1-13 (U.S. EPA, 1983-1989).

These documents may serve as valuable information resources to assist in the assessment of exposure. The reader is encouraged to refer to them for more detailed discussion.

In addition to the references listed above, this handbook discusses the recommendations provided by the American Industrial Health Council (AIHC) - Exposure Factors Sourcebook (May 1994) for some of the major exposure factors. The AIHC Sourcebook summarizes and evaluates statistical data for various exposure factors used in risk assessments. Probability distributions for

**1.3.2. Using the Handbook in an Exposure Assessment**

Some of the steps for performing an exposure assessment are (1) determining the pathways of exposure, (2) identifying the environmental media which transports the contaminant, (3) determining the contaminant concentration, (4) determining the exposure time, frequency, and duration, and (5) identifying the exposed population. Many of the issues related to characterizing exposure from selected exposure pathways have been addressed in a number of existing EPA guidance documents. These include, but are not limited to the following:

specific exposure factors were derived from the available scientific literature using @Risk simulation software. Each factor is described by a specific term, such as lognormal, normal, cumulative type, or triangular. Other distributions included Weibull, beta logistic, and gamma. Unlike this handbook, however, the Sourcebook does not provide a description and evaluation of every study available on each exposure factor.

Most of the data presented in this handbook are derived from studies that targeted (1) the general population (e.g., USDA food consumption surveys); and (2) a sample population from a specific area or group (e.g., Calabrese's et al. (1989) soil ingestion study using children from the Amherst, Massachusetts, area). Due to unique activity patterns, preferences, practices and biological differences, various segments of the population may experience exposures that are different from those of the general population, which, in many cases, may be greater. It is necessary for risk or exposure assessors characterizing a diverse population, to identify and enumerate certain groups within the general population who are at risk for greater contaminant exposures or exhibit a heightened

sensitivity to particular chemicals. For further guidance on addressing susceptible populations, it is recommended to consult the EPA, National Center for Environmental Assessment document *Socio-demographic Data Used for Identifying Potentially Highly Exposed Subpopulations* (to be released as a final document in the Fall of 1997).

Most users of the handbook will be preparing estimates of exposure which are to be combined with dose-response factors to estimate risk. Some of the exposure factors (e.g., life time, body weight) presented in this document are also used in generating dose-response relationships. In order to develop risk estimates properly, assessors must use dose-response relationships in a manner consistent with exposure conditions. Although, it is beyond the scope of this document to explain in detail how assessors should address this issue, a discussion (see Appendix A of this chapter) has been included which describes how dose-response factors can be modified to be

consistent with the exposure factors for a population of interest. This should serve as a guide for when this issue is a concern.

**1.3.3. Approach Used to Develop Recommendations for Exposure Factors**

As discussed above, EPA first reviewed all literature pertaining to a factor and determined relevant and key studies. The key studies were used to derive recommendations for the values of each factor. The recommended values were derived solely from EPA's interpretation of the available data. Different values may be appropriate for the user to select in consideration of policy, precedent, strategy, or other factors such as site-specific information. EPA's procedure for developing recommendations was as follows:

***Recommendations and Confidence Ratings***

- Recommendations based on data from single or multiple key studies
- Variability and limitation of the data evaluated
- Recommendations rated as low, medium, and

1. Key studies were evaluated in terms of both quality and relevance to specific populations (general U. S. population, age groups, gender, etc.). The criteria for assessing the quality of studies is described in Section 1.3.1.

2. If only one study was classified as key for a particular factor, the mean value from that study was selected as the recommended central value for that population. If there were multiple key studies, all with reasonably equal quality, relevance, and study design information were available, a weighted mean (if appropriate, considering sample size and other statistical factors) of the studies were chosen as the recommended mean value. If the key studies were judged to be unequal in quality, relevance, or study design, the range of means were presented and the user of this handbook must employ judgment in selecting the most appropriate value for the population of interest. In cases where the national population was of interest, the mid-point of the

range was usually judged to be the most appropriate value.

3. The variability of the factor across the population was discussed. If adequate data were available, the variability was described as either a series of percentiles or a distribution.
4. Limitations of the data were discussed in terms of data limitations, the range of circumstances over which the estimates were (or were not) applicable, possible biases in the values themselves, a statement about parameter uncertainties (measurement error, sampling error) and model or scenario uncertainties if models or scenarios have been used in the derivation of the recommended value.
5. Finally, EPA assigned a confidence rating of low, medium or high to each recommended value. This rating is not intended to represent an uncertainty analysis, rather it represents EPA's judgment on the quality of the underlying data used to derive the recommendation. This judgment was made using the guidelines shown in Table 1-1. Table 1-1 is an adaptation of the General Considerations discussed earlier in Section 1.3.1. Clearly this is a continuum from low to high and judgment was used to determine these ratings. Recommendations given in this handbook are accompanied by a discussion of the rationale for their rating.

Table 1-2 summarizes EPA's recommendations and confidence ratings for the various exposure factors.

It is important to note that the study elements listed in Table 1-1 do not have the same weight when arriving at the overall confidence rating for the various exposure factors. The relative weight of each of these elements depend on the exposure factor of interest. Also, the relative weights given to the elements for the various factors were subjective and based on the professional judgement of the authors of this handbook. In general, most studies would rank high with regard to "level of peer review," "accessibility," "focus on the factor of interest," and "data pertinent to the U.S." These elements are important for the study to be included in this handbook. However, a high score of these elements does not necessarily translate into a high overall score. Other elements in Table 1-1 were also examined to determine the overall score. For example, the adequacy of data collection period may be more important

when determining usual intake of foods in a population. On the other hand, it is not as important for factors where long-term variability may be small such as tapwater intake. In the case of tapwater intake, the currency of the data was a critical element in determining the final rating. In addition, some exposure factors are more easily measured than others. For example, soil ingestion by children is estimated by measuring, in the feces, the levels of certain elements found in soil. Body weight, however, can be measured directly and it is, therefore, a more reliable measurement. This is reflected in the confidence rating given to both of these factors. In general, the better the methodology used to measure the exposure factor, the higher the confidence in the value.

#### **1.3.4. Characterizing Variability**

This document attempts to characterize variability of each of the factors. Variability is characterized in one or more of three ways: (1) as tables with various percentiles or ranges of values; (2) as analytical distributions with specified parameters; and/or (3) as a qualitative discussion. Analyses to fit standard or parametric distributions (e.g., normal, lognormal) to the exposure data have not been performed by the authors of this handbook, but have been reproduced in this document wherever they were found in the literature. Recommendations on the use of these distributions are made where appropriate based on the adequacy of the supporting data. The list of exposure factors and the way that variability has been characterized (i.e., average, upper percentiles, multiple percentiles, fitted distribution) are presented in Table 1-3. The term upper percentile is used throughout this handbook and it is intended to represent values in the upper tail (i.e., between 90th and 99.9th percentile) of the distribution of values for a particular exposure factor.

An attempt was made to present percentile values in the recommendations that are consistent with the exposure estimators defined in the Exposure Guidelines (i.e., mean, 50th, 90th, 95th, 98th, and 99.9th percentile). This was not, however, always possible because either the data available were limited for some factors, or the authors of the study did not provide such information. It is important to note, however, that these percentiles were discussed in the Exposure Guidelines within the context of risk descriptors and not individual exposure factors. For example, the Guidelines stated

Table 1-1. Considerations Used to Rate Confidence in Recommended Values

<b>CONSIDERATIONS</b>	<b>HIGH CONFIDENCE</b>	<b>LOW CONFIDENCE</b>
<b>Study Elements</b>		
Level of peer review	The studies received high level of peer review (e.g., they appear in peer review journals).	The studies received limited peer review.
Accessibility	The studies are widely available to the public.	The studies are difficult to obtain (e.g., draft reports, unpublished data).
Reproducibility	The results can be reproduced or methodology can be followed and evaluated.	The results cannot be reproduced, the methodology is hard to follow, and the author(s) cannot be located.
Focus on factor of interest	The studies focused on the exposure factor of interest.	The purpose of the studies was to characterize a related factor.
Data pertinent to U.S.	The studies focused on the U.S. population.	The studies focused on populations outside the U.S.
Primary data	The studies analyzed primary data.	The studies are based on secondary sources.
Currency	The data were published after 1990.	The data were published before 1980.
Adequacy of data collection period	The study design captures the measurement of interest (e.g., usual consumption patterns of a population).	The study design does not very accurately capture the measurement of interest.
Validity of approach	The studies used the best methodology available to capture the measurement of interest.	There are serious limitations with the approach used.
Study sizes	The sample size is greater than 100 samples.	The sample size is less than 20 samples.
	The sample size depends on how the target population is defined. As the size of a sample relative to the total size of the target population increases, estimates are made with greater statistical assurance that the sample results reflect actual characteristics of the target population.	
Representativeness of the population	The study population is the same as population of interest.	The study population is very different from the population of interest. <sup>a</sup>
Variability in the population	The studies characterized variability in the population studied.	The characterization of variability is limited.
Lack of bias in study design (a high rating is desirable)	Potential bias in the studies are stated or can be determined from the study design.	The study design introduces biases in the results.
Response rates		The response rate is less than 40 percent.
In-person interviews	The response rate is greater than 80 percent.	The response rate is less than 40 percent.
Telephone interviews	The response rate is greater than 80 percent.	The response rate is less than 40 percent.
Mail surveys	The response rate is greater than 70 percent.	
Measurement error	The study design minimizes measurement errors.	Uncertainties with the data exist due to measurement error.
<b>Other Elements</b>		
Number of studies	The number of studies is greater than 3.	The number of studies is 1.
Agreement between researchers	The results of studies from different researchers are in agreement.	The results of studies from different researchers are in disagreement.

<sup>a</sup> Differences include age, sex, race, income, or other demographic parameters.

Table 1-2. Summary of Exposure Factor Recommendations and Confidence Ratings

EXPOSURE FACTOR	RECOMMENDATION	CONFIDENCE RATING
Drinking water intake rate	21 ml/kg-day/1.4 L/day (average)	Medium
	34 ml/kg-day/2.3 L/day (90th percentile) Percentiles and distribution also included Means and percentiles also included for pregnant and lactating women	Medium
Total fruit intake rate	3.4 g/kg-day ( per capita average)	Medium
	12.4 g/kg-day (per capita 95th percentile) Percentiles also included Means presented for individual fruits	Low
Total vegetable intake rate	4.3 g/kg-day ( per capita average)	Medium
	10 g/kg-day (per capita 95th percentile) Percentiles also included Means presented for individual vegetables	Low
Total meat intake rate	2.1 g/kg-day ( per capita average)	Medium
	5.1 g/kg-day (per capita 95th percentile) Percentiles also included Percentiles also presented for individual meats	Low
Total dairy intake rate	8.0 g/kg-day (per capita average)	Medium
	29.7 g/kg-day (per capita 95th percentile) Percentiles also included Means presented for individual dairy products	Low
Grain intake	4.1 g/kg-day (per capita average)	High
	10.8 g/kg-day (per capita 95th percentile) Percentiles also included	Low in long-term upper percentiles
Breast milk intake rate	742 ml/day (average)	Medium
	1,033 ml/day (upper percentile)	Medium
Fish intake rate	<u>General Population</u>	
	20.1 g/day (total fish) average	High
	14.1 g/day (marine) average	High
	6.0 g/day (freshwater/estuarine)average	High
	63 g/day (total fish) 95th percentile long-term	Medium
	Percentiles also included	
	<u>Serving size</u>	High
	129 g (average)	High
	326 g (95th percentile)	
	<u>Recreational marine anglers</u>	Medium
	2 - 7 g/day (finfish only)	
	<u>Recreational freshwater</u>	Medium
	8 g/day (average)	Medium
25 g/day (95th percentile)		
<u>Native American Subsistence Population</u>	Medium	
70 g/day (average)	Low	
170 g/day (95th percentile)		



Table 1-2. Summary of Exposure Factor Recommendations and Confidence Ratings (continued)

EXPOSURE FACTOR	RECOMMENDATION	CONFIDENCE RATING	
Home produced food intake	<u>Total Fruits</u> 2.7 g/kg-day (consumer only average) 11.1 g/kg-day (consumer only 95th percentile) Percentiles also included	Medium (for means and short-term distributions) Low (for long-term distributions)	
	<u>Total vegetables</u> 2.1 g/kg-day (consumer only average) 7.5 g/kg-day (consumer only 95th percentile) Percentiles also included		
	<u>Total meats</u> 2.2 g/kg-day (consumer only average) 6.8 g/kg-day (consumer only 95th percentile) Percentiles also included		
	<u>Total dairy products</u> 14 g/kg-day (consumer only average) 44 g/kg-day (consumer only 95th percentile) Percentiles also included		
	Inhalation rate	<u>Children (&lt;1 year)</u> 4.5 m <sup>3</sup> /day (average)	High
		<u>Children (1-12 years)</u> 8.7 m <sup>3</sup> /day (average)	High
		<u>Adult Females</u> 11.3 m <sup>3</sup> /day (average)	High
		<u>Adult Males</u> 15.2 m <sup>3</sup> /day (average)	High
		Surface area	<u>Water contact (bathing and swimming)</u> Use total body surface area for children in Tables 6-6 through 6-8; for adults use Tables 6-2 through 6-4 (percentiles are included)
	<u>Soil contact (outdoor activities)</u> Use whole body part area based on Table 6-6 through 6-8 for children and 6-2 through 6-4 for adults (percentiles are included)		High
	Soil adherence	Use values presented in Table 6-16 depending on activity and body part (central estimates only)	Low
	Soil ingestion rate	<u>Children</u> 100 mg/day (average) 400 mg/day (upper percentile)	Medium
		<u>Adults</u> 50 mg/day (average)	Low
<u>Pica child</u> 10 g/day		Low	
Life expectancy	75 years	High	
Body weight for adults	71.8 kg Percentiles also presented in tables 7-4 and 7-5	High	
Body weights for children	Use values presented in Tables 7-6 and 7-7 (mean and percentiles)	High	
Body weights for infants (birth to 6 months)	Use values presented in Table 7-1 (percentiles)	High	

Table 1-2. Summary of Exposure Factor Recommendations and Confidence Ratings (continued)

EXPOSURE FACTOR	RECOMMENDATION	CONFIDENCE RATING	
Showering/Bathing	<u>Showering time</u> 10 min/day (average) 35 min/day (95th percentile) (percentiles are also included)	High	
	<u>Bathing time</u> 20 min/event (median) 45 min/event (90th percentile)	High	
	<u>Bathing/showering frequency</u> 1 shower event/day	High	
	Swimming	<u>Frequency</u> 1 event/month	High
		<u>Duration</u> 60 min/event (median) 180 min/event (90th percentile)	High
Time indoors	<u>Children (ages 3-11)</u> 19 hr/day (weekdays) 17 hr/day (weekends)	Medium	
	<u>Adults (ages 12 and older)</u> 21 hr/day	Medium	
	<u>Residential</u> 16.4 hrs/day	High	
	Time outdoors	<u>Children (ages 3-11)</u> 5 hr/day (weekdays) 7 hr/day (weekends)	Medium
<u>Adults</u> 1.5 hr/day		Medium	
<u>Residential</u> 2 hrs/day		High	
Time spent inside vehicle		<u>Adults</u> 1 hr 20 min/day	Medium
Occupational tenure	6.6 years (16 years old and older)	High	
Population mobility	9 years (average)	Medium	
	30 years (95th percentile)	Medium	
Residence volume	369 m <sup>3</sup> (average)	Medium	
	217 m <sup>3</sup> (conservative)	Medium	
Residential air exchange	0.45 (median)	Low	
	0.18 (conservative)	Low	

Table 1-3. Characterization of Variability in Exposure Factors

Exposure Factors	Average	Upper percentile	Multiple Percentiles	Fitted Distributions
Drinking water intake rate	✓	✓	✓	✓
Total fruits and total vegetables intake rate	✓	✓ Qualitative discussion for long-term	✓	
Individual fruits and individual vegetables intake rate	✓			
Total meats and dairy products intake rate	✓	✓ Qualitative discussion for long-term	✓	
Individual meats and dairy products intake rate	✓			
Grains intake	✓	✓	✓	
Breast milk intake rate	✓	✓		
Fish intake rate for general population, recreational marine, recreational freshwater, and native american	✓	✓		
Serving size for fish	✓	✓	✓	
Homeproduced food intake rates	✓	✓	✓	
Soil intake rate	✓	Qualitative discussion for long-term		
Inhalation rate	✓	✓		
Surface area	✓	✓	✓	
Soil adherence	✓			
Life expectancy	✓			
Body weight	✓	✓	✓	
Time indoors	✓			
Time outdoors	✓			
Showering time	✓	✓	✓	
Occupational tenure	✓			
Population mobility	✓	✓	✓	
Residence volume	✓			
Residential air exchange	✓			

that the assessor may derive a high-end estimate of exposure by using maximum or near maximum values for one or more sensitive exposure factors, leaving others at their mean value.

The use of Monte Carlo or other probabilistic analysis require a selection of distributions or histograms for the input parameters. Although this handbook is not intended to provide a complete guidance on the use of Monte Carlo and other probabilistic analyses, the following should be considered when using such techniques:

- The exposure assessor should only consider using probabilistic analysis when there are credible distribution data (or ranges) for the factor under consideration. Even if these distributions are known, it may not be necessary to apply this technique. For example, if only average exposure values are needed, these can often be computed accurately by using average values for each of the input parameters. Probabilistic analysis is also not necessary when conducting assessments for screening

*Chapter 1 - Introduction*

---

purposes, i.e., to determine if unimportant pathways can be eliminated. In this case, bounding estimates can be calculated using maximum or near maximum values for each of the input parameters.

- It is important to note that the selection of distributions can be highly site specific and will always involve some degree of judgment. Distributions derived from national data may not represent local conditions. To the extent possible, an assessor should use distributions or frequency histograms derived from local surveys to assess risks locally. When distributional data are drawn from national or other surrogate population, it is important that the assessor address the extent to which local conditions may differ from the surrogate data.

In addition to a qualitative statement of uncertainty, the representativeness assumption should be appropriately addressed as part of a sensitivity analysis.

- Distribution functions to be used in Monte Carlo analysis may be derived by fitting an appropriate function to empirical data. In doing this, it should be recognized that in the lower and upper tails of the distribution the data are scarce, so that several functions, with radically different shapes in the extreme tails, may be consistent with the data. To avoid introducing errors into the analysis by the arbitrary choice of an inappropriate function, several techniques can be used. One way is to avoid the problem by using the empirical data itself rather than an analytic function. Another is to do separate analyses with several functions which have adequate fit but form upper and lower bounds to the empirical data. A third way is to use truncated analytical distributions. Judgment must be used in choosing the appropriate goodness of fit test. Information on the theoretical basis for fitting distributions can be found in a standard statistics text such as *Statistical Methods for Environmental Pollution Monitoring*, Gilbert, R.O., 1987, Van Nostrand Reinhold; off-the-shelf computer software such as Best-Fit by Palisade Corporation can be used

to statistically determine the distributions that fit the data.

- If only a range of values is known for an exposure factor, the assessor has several options.
  - keep that variable constant at its central value;
  - assume several values within the range of values for the exposure factor;
  - calculate a point estimate(s) instead of using probabilistic analysis; and
  - assume a distribution (The rationale for the selection of a distribution should be discussed at length.) There are, however, cases where assuming a distribution is not recommended. These include:
    - data are missing or very limited for a key parameter - examples include: soil ingestion by adults;
    - data were collected over a short time period and may not represent long term trends (the respondent usual behavior) - examples include: food consumption surveys; activity pattern data;
    - data are not representative of the population of interest because sample size was small or the population studied was selected from a local area and was therefore not representative of the area of interest - examples include: soil ingestion by children; and
    - ranges for a key variable are uncertain due to experimental error or other limitations in the study design or methodology - examples include: soil ingestion by children.

**1.4. GENERAL EQUATION FOR CALCULATING DOSE**

The definition of exposure as used in the Exposure Guidelines (U.S. EPA, 1992a) is "condition of a

chemical contacting the outer boundary of a human." This means contact with the visible exterior of a person such as the skin, and openings such as the mouth, nostrils, and lesions. The process of a chemical entering the body can be described in two steps: contact (exposure), followed by entry (crossing the boundary). The magnitude of exposure (dose) is the amount of agent available at human exchange boundaries (skin, lungs, gut) where absorption takes place during some specified time. An example of exposure and dose for the oral route as presented in the the EPA Exposure Guidelines is shown in Figure 1-1. Starting with a general integral equation for exposure (U.S. EPA 1992a), several dose equations can be derived depending upon boundary assumptions. One of the more useful of these derived equations is the Average Daily Dose (ADD). The ADD, which is used for many noncancer effects, averages exposures or doses over the period of time over which exposure occurred. The ADD can be calculated by averaging the potential dose ( $D_{pot}$ ) over body weight and an averaging time.

$$ADD_{pot} = \frac{\text{Total Potential Dose}}{\text{Body Weight} \times \text{Averaging Time}} \quad (\text{Eqn. 1-1})$$

For cancer effects, where the biological response is usually described in terms of lifetime probabilities, even though exposure does not occur over the entire lifetime, doses are often presented as lifetime average daily doses (LADDs). The LADD takes the form of the Equation 1-1 with lifetime replacing averaging time. The LADD is a very common term used in carcinogen risk assessment where linear non-threshold models are employed.

The total exposure can be expressed as follows:

$$\text{Total Potential Dose} = C \times IR \times ED \quad (\text{Eqn. 1-2})$$

Where:

- C = Contaminant Concentration
- IR = Intake Rate
- ED = Exposure Duration

Contaminant concentration is the concentration of the contaminant in the medium (air, food, soil, etc.) contacting the body and has units of mass/volume or mass/mass.

The intake rate refers to the rates of inhalation, ingestion, and dermal contact depending on the route of exposure. For ingestion, the intake rate is simply the amount of food containing the contaminant of interest that an individual ingests during some specific time period (units of mass/time). Much of this handbook is devoted to rates of ingestion for some broad classes of food. For inhalation, the intake rate is the rate at which contaminated air is inhaled. Factors that affect dermal exposure are the amount of material that comes into contact with the skin, and the rate at which the contaminant is absorbed.

The exposure duration is the length of time that contaminant contact lasts. The time a person lives in an area, frequency of bathing, time spent indoors versus outdoors, etc. all affect the exposure duration. The Activity Factors Chapter (Volume III, Chapter 15) gives some examples of population behavior patterns, which may be useful for estimating exposure durations to be used in the exposure calculations.

When the above parameter values remain constant over time, they are substituted directly into the exposure equation. When they change with time, a summation approach is needed to calculate exposure. In either case, the exposure duration is the length of time exposure occurs at the concentration and intake rate specified by the other parameters in the equation.

Dose can be expressed as a total amount (with units of mass, e.g., mg) or as a dose rate in terms of mass/time (e.g., mg/day), or as a rate normalized to body mass (e.g., with units of mg of chemical per kg of body weight per day (mg/kg-day)). The LADD is usually expressed in terms of mg/kg-day or other mass/mass-time units.

In most cases (inhalation and ingestion exposure) the dose-response parameters for carcinogen risks have been adjusted for the difference in absorption across body barriers between humans and the experimental animals used to derive such parameters. Therefore, the exposure assessment in these cases is based on the potential dose with no explicit correction for the fraction absorbed. However, the exposure assessor needs to make such an adjustment when calculating dermal exposure and in other specific cases when current information indicates that the human absorption factor

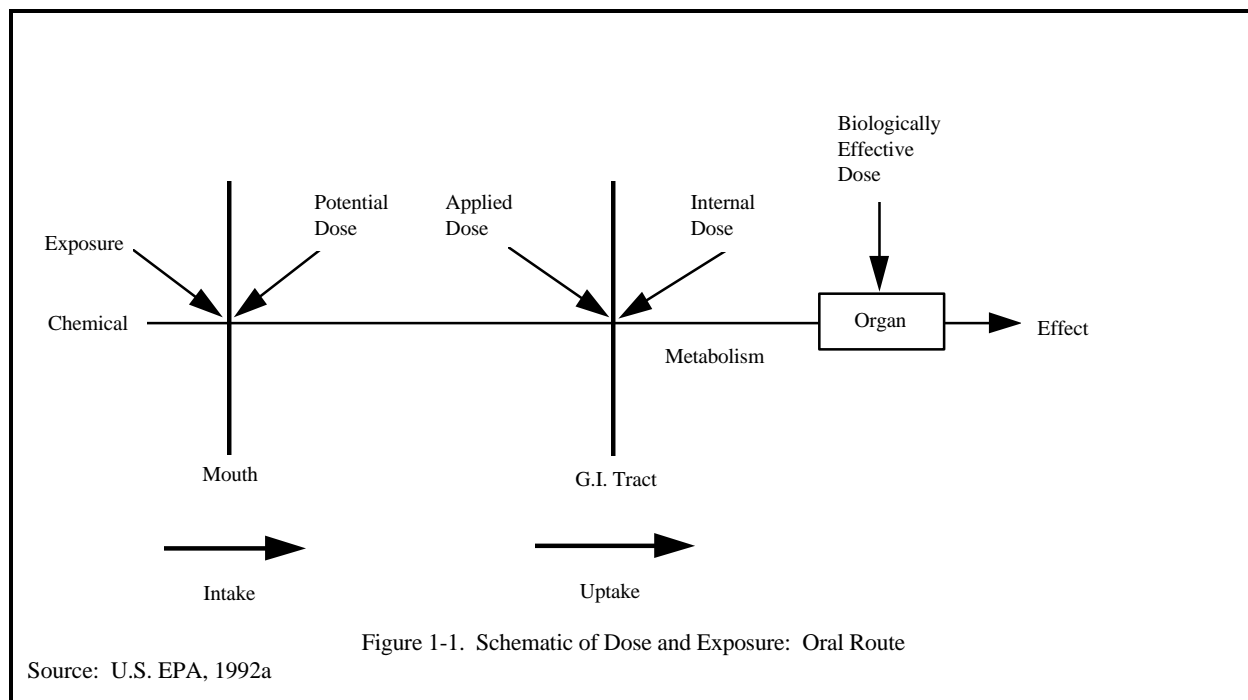

used in the derivation of the dose-response factor is inappropriate.

The lifetime value used in the LADD version of Equation 1-1 is the period of time over which the dose is averaged. For carcinogens, the derivation of the dose-response parameters usually assumes no explicit number of years as the duration of a lifetime, and the nominal value of 75 years is considered a reasonable approximation. For exposure estimates to be used for assessments other than carcinogenic risk, various averaging periods have been used. For acute exposures, the administered doses are usually averaged over a day or a single event. For nonchronic noncancer effects, the time period used is the actual period of exposure. The objective in selecting the exposure averaging time is to express the exposure in a way which can be combined with the dose-response relationship to calculate risk.

The body weight to be used in the exposure Equation 1-1 depends on the units of the exposure data presented in this handbook. For food ingestion, the body weights of the surveyed populations were known in the USDA surveys and they were explicitly factored into the food intake data in order to calculate the intake as grams per day per kilogram body weight. In this case, the body weight has already been

included in the "intake rate" term in Equation 1-2 and the exposure assessor does not need to explicitly include body weight.

The units of intake in this handbook for the ingestion of fish, breast milk, and the inhalation of air are not normalized to body weight. In this case, the exposure assessor needs to use (in Equation 1-1) the average weight of the exposed population during the time when the exposure actually occurs. If the exposure occurs continuously throughout an individual's life or only during the adult ages, using an adult weight of 71.8 kg should provide sufficient accuracy. If the body weight of the individuals in the population whose risk is being evaluated is non-standard in some way, such as for children or for first-generation immigrants who may be smaller than the national population, and if reasonable values are not available in the literature, then a model of intake as a function of body weight must be used. One such model is discussed in Appendix 1A of this chapter. Some of the parameters (primarily concentrations) used in estimating exposure are exclusively site specific, and therefore default recommendations could not be used.

The food ingestion rate values provided in this handbook are generally expressed as "as consumed" since this is the fashion in which data are reported by survey

respondents. This is of importance because concentration data to be used in the dose equation are generally measured in uncooked food samples. In most situations, the only practical choice is to use the "as consumed" ingestion rate and the uncooked concentration. However, it should be recognized that cooking generally results in some reductions in weight (e.g., loss of moisture), and that if the mass of the contaminant in the food remains constant, then the concentration of the contaminant in the cooked food item will increase. Therefore, if the "as consumed" ingestion rate and the uncooked concentration are used in the dose equation, dose may be underestimated. On the other hand, cooking may cause a reduction in mass of contaminant and other ingredients such that the overall concentration of contaminant does not change significantly. In this case, combining cooked ingestion rates and uncooked concentration will provide an appropriate estimate of dose. Ideally, food concentration data should be adjusted to account for changes after cooking, then the "as consumed" intake rates are appropriate. In the absence of data, it is reasonable to assume that no change in contaminant concentration occurs after cooking. Except for general population fish consumption and home produced foods, uncooked intake rate data were not available for presentation in this handbook. Data on the general population fish consumption have been presented in this handbook (Section 10.2) in both "as consumed" and uncooked basis. It is important for the assessor to be aware of these issues and choose intake rate data that best matches the concentration data that is being used.

The link between the intake rate value and the exposure duration value is a common source of confusion in defining exposure scenarios. It is important to define the duration estimate so that it is consistent with the intake rate:

- The intake rate can be based on an individual event, such as 129 g of fish eaten per meal (U.S. EPA, 1996). The duration should be based on the number of events or, in this case, meals.
- The intake rate also can be based on a long-term average, such as 10 g/day. In this case the duration should be based on the total time interval over which the exposure occurs.

The objective is to define the terms so that when multiplied, they give the appropriate estimate of mass of contaminant contacted. This can be accomplished by basing the intake rate on either a long-term average (chronic exposure) or an event (acute exposure) basis, as long as the duration value is selected appropriately. Consider the case in which a person eats a 129-g fish meal approximately five times per month (long-term average is 21.5 g/day) for 30 years; or 21.5 g/day of fish every day for 30 years.

$$(129 \text{ g/meal})(5 \text{ meals/mo})(\text{mo}/30 \text{ d})(365 \text{ d/yr})(30 \text{ yrs}) = 235,425 \text{ g}$$

$$(21.5 \text{ g/day})(365 \text{ d/yr})(30 \text{ yrs}) = 235,425 \text{ g}$$

Thus, a frequency of either 60 meals/year or a duration of 365 days/year could be used as long as it is matched with the appropriate intake rate.

**1.5. RESEARCH NEEDS**

In an earlier draft of this handbook, reviewers were asked to identify factors or areas where further research is needed. The following list is a compilation of areas for future research identified by the peer reviewers and authors of this document:

- The data and information available with respect to occupational exposures are quite limited. Efforts need to be directed to identify data or references on occupational exposure.
- Further research is necessary to refine estimates of fish consumption, particularly by subpopulations of subsistence fishermen.
- Research is needed to better estimate soil intake rates, particularly how to extrapolate short-term data to chronic exposures. Data on soil intake rates by adults are very limited. Research in this area is also recommended. Research is also needed to refine methods to calculate soil intake rate (i.e., inconsistencies among tracers and input/output misalignment errors indicate a fundamental problem with the methods). Research is also needed to obtain more data to better estimate soil adherence.

---

*Chapter 1 - Introduction*

---

- In cases where several studies of equal quality and data collection procedures are available for an exposure factor, procedures need to be developed to combine the data in order to create a single distribution of likely values for that factor.
- Reviewers recommended that the handbook be made available in CD ROM and that the data presented be made available in a format that will allow the users to conduct their own analysis. The intent is to provide a comprehensive factors tool with interactive menu to guide users to areas of interest, word searching features, and data base files.
- Reviewers recommended that EPA derive distribution functions using the empirical data for the various exposure factors to be used in Monte Carlo or other probabilistic analysis.
- Research is needed to derive a methodology to extrapolate from short-term data to long-term or chronic exposures.
- Reviewers recommended that the consumer products chapter be expanded to include more products. A comprehensive literature search needs to be conducted to investigate other sources of data.
- Breastmilk intake.
- More recent data on tapwater intake.
- SAB recommended analysis of 1994 and 1995 CSFII data.

**1.6. ORGANIZATION**

The handbook is organized into three volumes as follows:

**Volume I - General Factors**

- Chapter 1 Provides the overall introduction to the handbook
- Chapter 2 Presents an analysis of uncertainty and discusses methods that can be used to

evaluate and present the uncertainty associated with exposure scenario estimates.

- Chapter 3 Provides factors for estimating human exposure through ingestion of water.
- Chapter 4 Provides factors for estimating exposure through ingestion of soil.
- Chapter 5 Provides factors for estimating exposure as a result of inhalation of vapors and particulates.
- Chapter 6 Presents factors for estimating dermal exposure to environmental contaminants that come in contact with the skin.
- Chapter 7 Provides data on body weight.
- Chapter 8 Provides data on life expectancy.

**Volume II - Ingestion Factors**

- Chapter 9 Provides factors for estimating exposure through ingestion of fruits and vegetables.
- Chapter 10 Provides factors for estimating exposure through ingestion of fish.
- Chapter 11 Provides factors for estimating exposure through ingestion of meats and dairy products.
- Chapter 12 Presents data for estimating exposure through ingestion of grain products.
- Chapter 13 Presents factors for estimating exposure through ingestion of home produced food.
- Chapter 14 Presents data for estimating exposure through ingestion of breast milk.



**Volume III - Activity Factors**

- Chapter 15 Presents data on activity factors (activity patterns, population mobility, and occupational mobility).
- Chapter 16 Presents data on consumer product use.
- Chapter 17 Presents factors used in estimating residential exposures.

Figure 1-2 provides a roadmap to assist users of this handbook in locating recommended values and confidence ratings for the various exposure factors presented in these chapters. A glossary is provided at the end of Volume III.

**1.7. REFERENCES FOR CHAPTER 1**

- AIHC. (1994) Exposure factors sourcebook. Washington, DC: American Industrial Health Council.
- Calabrese, E.J.; Pastides, H.; Barnes, R.; Edwards, C.; Kostecki, P.T.; et al. (1989) How much soil do young children ingest: an epidemiologic study. In: Petroleum Contaminated Soils, Lewis Publishers, Chelsea, MI. pp. 363-397.
- Gilbert, R.O. (1987) Statistical methods for environmental pollution monitoring. New York: Van Nostrand Reinhold.
- U.S. EPA. (1983-1989) Methods for assessing exposure to chemical substances. Volumes 1-13. Washington, DC: Office of Toxic Substances, Exposure Evaluation Division.
- U.S. EPA. (1984) Pesticide assessment guidelines subdivision K, exposure: reentry protection. Office of Pesticide Programs, Washington, DC. EPA/540/9-48/001. Available from NTIS, Springfield, VA; PB-85-120962.
- U.S. EPA. (1986a) Standard scenarios for estimating exposure to chemical substances during use of consumer products. Volumes I and II. Washington, DC: Office of Toxic Substance, Exposure Evaluation Division.
- U.S. EPA. (1986b) Pesticide assessment guidelines subdivision U, applicator exposure monitoring. Office of Pesticide Programs, Washington, DC. EPA/540/9-87/127. Available from NTIS, Springfield, VA; PB-85-133286.
- U.S. EPA. (1987) Selection criteria for mathematical models used in exposure assessments: surface water models. Exposure Assessment Group, Office of Health and Environmental Assessment, Washington, DC. WPA/600/8-87/042. Available from NTIS, Springfield, VA; PB-88-139928/AS.
- U.S. EPA. (1988a) Superfund exposure assessment manual. Office of Emergency and Remedial Response, Washington, DC. EPA/540/1-88/001. Available from NTIS, Springfield, VA; PB-89-135859.
- U.S. EPA. (1988b) Selection criteria for mathematical models used in exposure assessments: groundwater models. Exposure Assessment Group, Office of Health and Environmental Assessment, Washington, DC. EPA/600/8-88/075. Available from NTIS, Springfield, VA; PB-88-248752/AS.
- U.S. EPA. (1989) Risk assessment guidance for Superfund. Human health evaluation manual: part A. Interim Final. Office of Solid Waste and Emergency Response, Washington, DC. Available from NTIS, Springfield, VA; PB-90-155581.
- U.S. EPA. (1990) Methodology for assessing health risks associated with indirect exposure to combustor emissions. EPA 600/6-90/003. Available from NTIS, Springfield, VA; PB-90-187055/AS.
- U.S. EPA. (1992a) Guidelines for exposure assessment. Washington, DC: Office of Research and Development, Office of Health and Environmental Assessment. EPA/600/Z-92/001.
- U.S. EPA. (1992b) Dermal exposure assessment: principles and applications. Washington, DC: Office of Health and Environmental Assessments. EPA/600/8-9/011F.
- U.S. EPA. (1994) Estimating exposures to dioxin-like compounds. (Draft Report). Office of Research and Development, Washington, DC. EPA/600/6-88/005Cb.
- U.S. EPA. (1996) Daily average per capita fish consumption estimates based on the combined 1989, 1990, and 1999 continuing survey of food intakes by individuals (CSFII) 1989-91 data. Volumes I and II. Preliminary Draft Report. Washington, DC: Office of Water.

EXPOSURE ROUTE	EXPOSURE FACTOR	POPULATION	VOLUME	CHAPTER	RECOMMENDATIONS/ RATINGS TABLE PAGE NOS.	
Ingestion	Drinking Water Intake Rate	Adults Children Pregnant Women High Activity	I	3.	3-23/3-39	
	Fruit and Vegetable Intake Rate	Various Demographic Groups — Age, Region, Season, Urbanization, Race	II	9.	9-7/9-45	
	Meat and Dairy Intake Rate		II	11.	11-7/11-32	
	Homegrown Foods		II	13.	13-10/13-67	
	Breast milk Intake Rate		II	14.	14-7/14-13	
	Fish and Shellfish Intake Rate		General Population	II	10.	10-25/10-85
			Freshwater Recreational	II	10.	10-26/10-87
			Marine Recreational	II	10.	10-26/10-86
			Subsistence	II	10.	10-26/10-88
	Soil Intake Rate	Typical Children Adults Pica Children	I	4.	4-20/4-21	
Grain Intake			II	12.	12-5/12-23	
Inhalation	Inhalation Rate	Adults Children High Activity	I	5.	5-22/5-23	
		Dermal	Skin Surface Area	Adults Children	I	6.
Soil Adherence	General Population		I	6.	6-8/6-27	
(All Routes) Human Characteristics	Body Weight	Adults Children	I	7.	7-10/7-12	
		Lifetime	Adults Children	I	8.	8-1/8-5
(All Routes) Activity Factors	Activity Patterns	Adults Children	III	15.	15-15/15-164	
		Occupational Mobility	Adults	III	15.	15-17/15-171
	Population Mobility	Adults Children	III	15.	15-17/15-172	
(All Routes) Consumer Product Use	Frequency of Use	Adults	III	16.	16-5	
	Amount Used	Adults				
(All Routes) Residential Building Characteristics	Water Use Air Exchange Rates House Volumes Building Characteristics	General Population	III	17.	17-6/17-30, 17-31	

**APPENDIX 1A**

**RISK CALCULATIONS USING EXPOSURE FACTORS HANDBOOK DATA  
AND DOSE-RESPONSE INFORMATION FROM THE  
INTEGRATED RISK INFORMATION SYSTEM (IRIS)**



**APPENDIX 1A  
RISK CALCULATIONS USING EXPOSURE FACTORS HANDBOOK  
DATA AND DOSE-RESPONSE INFORMATION FROM IRIS**

**1. INTRODUCTION**

When calculating risk estimates for a specific population, whether the entire national population or some sub-population, the exposure information (either from this handbook or from other data) must be combined with dose-response information. The latter typically comes from the IRIS data base, which summarizes toxicity data for each agent separately. Care must be taken that the assumptions about population parameters in the dose-response analysis are consistent with the population parameters used in the exposure analysis. This Appendix discusses procedures for insuring this consistency.

In the IRIS derivation of threshold based dose-response relationships (U.S. EPA, 1996), such as the RfD and the RfCs based on adverse systemic effects, there has generally been no explicit use of human exposure factors. In these cases the numerical value of the RfD and RfC comes directly from animal dosing experiments (and occasionally from human studies) and from the application of uncertainty factors to reflect issues such as the duration of the experiment, the fact that animals are being used to represent humans and the quality of the study. However in developing cancer dose-response (D-R) assessments, a standard exposure scenario is assumed in calculating the slope factor (i.e., human cancer risk per unit dose) on the basis of either animal bioassay data or human data. This standard scenario has traditionally been assumed to be typical of the U.S. population: 1) body weight = 70 kg; 2) air intake rate = 20 m<sup>3</sup>/day; 3) drinking water intake = 2 liters/day; 4) lifetime = 70 years. In RfC derivations for cases involving an adverse effect on the respiratory tract, the air intake rate of 20 m<sup>3</sup>/day is assumed. The use of these specific values has depended on whether the slope factor was derived from animal or human epidemiologic data:

- **Animal Data:** For dose-response (D-R) studies based on animal data, scale animal doses to human equivalent doses using a human body weight assumption of 70 kg. No explicit lifetime adjustment is necessary because the assumption is made that events occurring in the lifetime animal bioassay will occur with equal probability in a human lifetime, whatever that might happen to be.
- **Human Data -** In the analysis of human studies (either occupational or general population), the Agency has usually made no explicit assumption of body weight or human lifetime. For both of these parameters there is an implicit assumption that the population usually of interest has the same descriptive parameters as the population analyzed by the Agency. In the rare situation where this assumption is known to be wrong, the Agency has made appropriate corrections so that the dose-response parameters represent the national average population.

When the population of interest is different than the national average (standard) population, the dose-response parameter needs to be adjusted. In addition, when the population of interest is different than the population from which the exposure factors in this handbook were derived, the exposure factor needs to be adjusted. Two generic examples of situations where these adjustments are needed are as follows:

A) Detailed study of recent data, such as are presented in this handbook, show that EPA's standard assumptions (i.e., 70 kg body weight, 20 m<sup>3</sup>/day air inhaled, and 2 L/day water intake) are inaccurate for the national population and may be inappropriate for sub-populations under consideration. The handbook addresses most of these situations by providing gender- and age-specific values and by normalizing the intake values to body weight when the data are available, but it may not have covered all possible situations. An example of a sub-population with a different mean body weight would be females, with an average body weight of 60 kg or children with a body weight dependent on age. Another example of a non-standard sub-population would be a sedentary hospital population with lower than 20 m<sup>3</sup>/day air intake rates.

B) The population variability of these parameters is of interest and it is desired to estimate percentile limits of the population variation. Although the detailed methods for estimating percentile limits of exposure and risk in a population are beyond the scope of this document, one would treat the body weight and the intake rates discussed in Sections 2 to 4 of this appendix as distributions, rather than constants.

**2. CORRECTIONS FOR DOSE-RESPONSE PARAMETERS**

The correction factors for the dose-response values tabulated in the IRIS data base for carcinogens are summarized in Table 1A-1. Use of these correction parameters is necessary to avoid introducing errors into the risk analysis. The second column of Table 1A-1 shows the dependencies that have been assumed in the typical situation where the human dose-response factors have been derived from the administered dose in animal studies. This table is applicable in most cases that will be encountered, but it is not applicable when: a) the effective dose has been derived with a pharmacokinetic model and b) the dose-response data has been derived from human data. In the former case, the subpopulation parameters need to be incorporated into the model. In the latter case, the correction factor for the dose-response parameter must be evaluated on a case-by case basis by examining the specific data and assumptions in the derivation of the parameter.

Table 1A-1. Procedures for Modifying IRIS Risk Values for Non-standard Populations<sup>a,b</sup>

IRIS Risk Measure [Units]	IRIS Risk Measure is Proportional to: <sup>b</sup>	Correction Factor (CF) for modifying IRIS Risk Measures: <sup>c</sup>
Slope Factor [per mg/(kg/day)]	$(W^S)^{1/3} = (70)^{1/3}$	$(W^P/70)^{1/3}$
Water Unit Risk [per µg/l]	$I_W^S / [(W^S)^{2/3}] = 2 / [(70)^{2/3}]$	$(I_W^P) / 2 \times [70 / (W^P)]^{2/3}$
Air Unit Risk: A. Particles or aerosols [per µg/m <sup>3</sup> ], air concentration by weight	$I_A^S / [(W^S)^{2/3}] = 20 / [(70)^{2/3}]$	$(I_A^P) / 20 \times [70 / (W^P)]^{2/3}$
Air Unit Risk: B. Gases [per parts per million], air concentration by volume,	No explicit proportionality to body weight or air intake is assumed.	1.0 ppm by volume is assumed to be the effective dose in both animals and humans.

<sup>a</sup> W = Body weight (kg)  
I<sub>w</sub> = Drinking water intake (liters per day)  
I<sub>A</sub> = Air intake (cubic meters per day)

<sup>b</sup> W<sup>S</sup>, I<sub>w</sub><sup>S</sup>, I<sub>A</sub><sup>S</sup> denote standard parameters assumed by IRIS

<sup>c</sup> Modified risk measure = (CF) x IRIS value  
W<sup>P</sup>, I<sub>w</sub><sup>P</sup>, I<sub>A</sub><sup>P</sup> denote non-standard parameters of the actual population

As one example of the use of Table 1A-1, the recommended value for the average consumption of tapwater for adults in the U. S. population derived in this document (Chapter 3), is 1.4 liters per day. The drinking water unit risk for dichlorvos, as given in the IRIS information data base is 8.3 x 10<sup>-6</sup> per µg/l, and was calculated from the slope factor assuming the standard intake, I<sub>w</sub><sup>S</sup>, of 2 liters per day. For the United States population drinking 1.4 liters of tap water per

Appendix 1A

day the corrected drinking water unit risk should be  $8.3 \times 10^{-6} \times (1.4/2) = 5.8 \times 10^{-6}$  per  $\mu\text{g/l}$ . The risk to the average individual is then estimated by multiplying this by the average concentration in units of  $\mu\text{g/l}$ .

Another example is when the risk for women drinking water contaminated with dichlorvos is to be estimated. If the women have an average body weight of 60 kg, the correction factor for the drinking water unit risk is (disregarding the correction discussed in the above paragraph), from Table 1A-1, is  $(70/60)^{2/3} = 1.11$ . Here the ratio of 70 to 60 is raised to the power of 2/3. The corrected water unit risk for dichlorvos is  $8.3 \times 10^{-6} \times 1.11 = 9.2 \times 10^{-6}$  per  $\mu\text{g/l}$ . As before, the risk to the average individual is estimated by multiplying this by the water concentration.

When human data are used to derive the risk measure, there is a large variation in the different data sets encountered in IRIS, so no generalizations can be made about global corrections. However, the typical default exposure values used for the air intake of an air pollutant over an occupational lifetime are: air intake is  $10 \text{ m}^3/\text{day}$  for an 8-hour shift, 240 days per year with 40 years on the job. If there is continuous exposure to an ambient air pollutant, the lifetime dose is usually calculated assuming a 70-year lifetime.

**3. CORRECTIONS FOR INTAKE DATA**

When the body weight,  $W^P$ , of the population of interest differs from the body weight,  $W^E$ , of the population from which the exposure values in this handbook were derived, the following model furnishes a reasonable basis for estimating the intake of food and air (and probably water also) in the population of interest. Such a model is needed in the absence of data on the dependency of intake on body size. This occurs for inhalation data, where the intake data are not normalized to body weight, whereas the model is not needed for food and tap water intakes if they are given in units of intake per kg body weight.

The model is based on the dependency of metabolic oxygen consumption on body size. Oxygen consumption is directly related to food (calorie) consumption and air intake and indirectly to water intake. For mammals of a wide range of species sizes (Prosser and Brown, 1961), and also for individuals of various sizes within a species, the oxygen consumption and calorie (food) intake varies as the body weight raised to a power between 0.65 and 0.75. A value of  $0.667 = 2/3$  has been used in EPA as the default value for adjusting cross-species intakes, and the same factor has been used for intra-species intake adjustments.

[NOTE: Following discussions by an interagency task force (Federal Register, 1992), the agreement was that a more accurate and defensible default value would be to choose the power to 3/4 rather than 2/3. A recent article (West et al., 1997) has provided a theoretical basis for the 3/4 power scaling. This will be the standard value to be used in future assessments, and all equations in this Appendix will be modified in future risk assessments. However, because risk assessors now use the current IRIS information, this discussion is presented with the previous default assumption of 2/3].

With this model, the relation between the daily air intake in the population of interest,  $I_A^P = (\text{m}^3/\text{day})^P$ , and the intake in the population described in this handbook,  $I_A^E = (\text{m}^3/\text{day})^E$  is:

$$I_A^P = I_A^E \times (W^P/W^E)^{2/3}.$$

**4. CALCULATION OF RISKS FOR AIR CONTAMINANTS**

The risk is calculated by multiplying the IRIS air unit risk, corrected as described in Table 1A-1, by the air concentration. But since the correction factor involves the intake in the population of interest ( $I_A^P$ ), that quantity must be included in the equation, as follows:

$$\begin{aligned} (\text{Risk})^P &= (\text{air unit risk})^P \times (\text{air concentration}) \\ &= (\text{air unit risk})^S \times (I_A^P/20) \times (70/W^P)^{2/3} \times (\text{air concentration}) \end{aligned}$$

$$\begin{aligned} &= (\text{air unit risk})^S \times [(I_A^E \times (W^P/W^E)^{2/3}/20)] \times (70/W^P)^{2/3} \times (\text{air concentration}) \\ &= (\text{air unit risk})^S \times (I_A^E/20) \times (70/W^E)^{2/3} \times (\text{air concentration}) \end{aligned}$$

In this equation the air unit risk from the IRIS data base (air unit risk)<sup>S</sup>, the air intake data in the handbook for the populations where it is available (I<sub>A</sub><sup>E</sup>) and the body weight of that population (W<sup>E</sup>) are included along with the standard IRIS values of the air intake (20 m<sup>3</sup>/day) and body weight (70 kg).

For food ingestion and tap water intake, if body weight-normalized intake values from this handbook are used, the intake data do not have to be corrected as in Section 3 above. In these cases, corrections to the dose-response parameters in Table 1A-1 are sufficient.

## 5. REFERENCES

- Federal Register. (1992) Cross-species scaling factor for carcinogen risk assessments based on equivalence of (mg/kg-day)<sup>3/4</sup>. Draft report. Federal Register, 57(109): 24152-24173, June 5, 1992.
- Prosser, C.L.; Brown, F.A. (1961) Comparative Animal physiology, 2nd edition. WB Saunders Co. p. 161.
- U.S. EPA. (1996) Background Documentation. Integrated Risk Information System (IRIS). Online. National Center for Environmental Assessment, Cincinnati, Ohio. Background Documentation available from: Risk Information Hotline, National Center for Environmental Assessment, U.S. EPA, 26 W. Martin Luther King Dr. Cincinnati, OH 45268. (513) 569-7254
- West, G.B.; Brown, J.H.; Enquist, B.J. (1997) A general model of the origin of allometric scaling laws in biology. Science 276:122-126.



## TABLE OF CONTENTS

	<u>Page No.</u>
2. VARIABILITY AND UNCERTAINTY .....	1
2.1. VARIABILITY VERSUS UNCERTAINTY .....	1
2.2. TYPES OF VARIABILITY .....	2
2.3. CONFRONTING VARIABILITY .....	3
2.4. CONCERN ABOUT UNCERTAINTY .....	3
2.5. TYPES OF UNCERTAINTY AND REDUCING UNCERTAINTY .....	4
2.6. ANALYZING VARIABILITY AND UNCERTAINTY .....	4
2.7. PRESENTING RESULTS OF VARIABILITY AND UNCERTAINTY ANALYSIS .....	6
<b>2.8. REFERENCES FOR CHAPTER 2 .....</b>	<b>7</b>

**2. VARIABILITY AND UNCERTAINTY**

The chapters that follow will discuss exposure factors and algorithms for estimating exposure. Exposure factor values can be used to obtain a range of exposure estimates such as average, high-end and bounding estimates. It is instructive here to return to the general equation for potential Average Daily Dose (ADD<sub>pot</sub>) that was introduced in the opening chapter of this handbook:

$$ADD_{pot} = \frac{\text{Contaminant Concentration} \times \text{Intake Rate} \times \text{Exposure Duration}}{\text{Body Weight} \times \text{Averaging Time}} \quad (\text{Eqn. 2-1})$$

With the exception of the contaminant concentration, all parameters in the above equation are considered exposure factors and, thus, are treated in fair detail in other chapters of this handbook. Each of the exposure factors involves humans, either in terms of their characteristics (e.g., body weight) or behaviors (e.g., amount of time spent in a specific location, which affects exposure duration). While the topics of variability and uncertainty apply equally to contaminant concentrations and the rest of the exposure factors in equation 2-1, the focus of this chapter is on variability and uncertainty as they relate to exposure factors. Consequently, examples provided in this chapter relate primarily to exposure factors, although contaminant concentrations may be used when they better illustrate the point under discussion.

This chapter also is intended to acquaint the exposure assessor with some of the fundamental concepts and precepts related to variability and uncertainty, together with methods and considerations for evaluating and presenting the uncertainty associated with exposure estimates. Subsequent sections in this chapter are devoted to the following topics:

- Distinction between variability and uncertainty;
- Types of variability;
- Methods of confronting variability;
- Types of uncertainty and reducing uncertainty;
- Analysis of variability and uncertainty; and
- Presenting results of variability/uncertainty analysis.

Fairly extensive treatises on the topic of uncertainty have been provided, for example, by Morgan and Henrion (1990), the National Research Council (NRC, 1994) and, to a lesser extent, the U.S. EPA (1992; 1995). The topic

commonly has been treated as it relates to the overall process of conducting risk assessments; because exposure assessment is a component of risk-assessment process, the general concepts apply equally to the exposure-assessment component.

**2.1. VARIABILITY VERSUS UNCERTAINTY**

While some authors have treated variability as a specific type or component of uncertainty, the U.S. EPA (1995) has advised the risk assessor (and, by analogy, the exposure assessor) to distinguish between variability and uncertainty. Uncertainty represents a lack of knowledge about factors affecting exposure or risk, whereas variability arises from true heterogeneity across people, places or time. In other words, uncertainty can lead to inaccurate or biased estimates, whereas variability can affect the precision of the estimates and the degree to which they can be generalized. Most of the data presented in this handbook concerns variability.

Variability and uncertainty can complement or confound one another. An instructive analogy has been drawn by the National Research Council (NRC, 1994: Chapter 10), based on the objective of estimating the distance between the earth and the moon. Prior to fairly recent technology developments, it was difficult to make accurate measurements of this distance, resulting in measurement uncertainty. Because the moon's orbit is elliptical, the distance is a variable quantity. If only a few measurements were to be taken without knowledge of the elliptical pattern, then either of the following incorrect conclusions might be reached:

- That the measurements were faulty, thereby ascribing to uncertainty what was actually caused by variability; or
- That the moon's orbit was random, thereby not allowing uncertainty to shed light on seemingly unexplainable differences that are in fact variable and predictable.

A more fundamental error in the above situation would be to incorrectly estimate the true distance, by assuming that a few observations were sufficient. This latter pitfall -- treating a highly variable quantity as if it were invariant or only uncertain -- is probably the most relevant to the exposure or risk assessor.

Now consider a situation that relates to exposure, such as estimating the average daily dose by one exposure

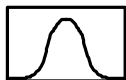

route -- ingestion of contaminated drinking water. Suppose that it is possible to measure an individual's daily water consumption (and concentration of the contaminant) exactly, thereby eliminating uncertainty in the measured daily dose. The daily dose still has an inherent day-to-day variability, however, due to changes in the individual's daily water intake or the contaminant concentration in water.

It is impractical to measure the individual's dose every day. For this reason, the exposure assessor may estimate the average daily dose (ADD) based on a finite number of measurements, in an attempt to "average out" the day-to-day variability. The individual has a true (but unknown) ADD, which has now been estimated based on a sample of measurements. Because the individual's true average is unknown, it is uncertain how close the estimate is to the true value. Thus, the variability across daily doses has been translated into uncertainty in the ADD. Although the individual's true ADD has no variability, the estimate of the ADD has some uncertainty.

The above discussion pertains to the ADD for one person. Now consider a distribution of ADDs across individuals in a defined population (e.g., the general U.S. population). In this case, variability refers to the range and distribution of ADDs across individuals in the population. By comparison, uncertainty refers to the exposure assessor's state of knowledge about that distribution, or about parameters describing the distribution (e.g., mean, standard deviation, general shape, various percentiles).

As noted by the National Research Council (NRC, 1994), the realms of variability and uncertainty have fundamentally different ramifications for science and judgment. For example, uncertainty may force decision-makers to judge how probable it is that exposures have been overestimated or underestimated for every member of the exposed population, whereas variability forces them to cope with the certainty that different individuals are subject to exposures both above and below any of the exposure levels chosen as a reference point.

## 2.2. TYPES OF VARIABILITY

Variability in exposure is related to an individual's location, activity, and behavior or preferences at a particular point in time, as well as pollutant emission rates and physical/chemical processes that affect concentrations in various media (e.g., air, soil, food and water). The variations in pollutant-specific emissions or processes, and in individual locations, activities or behaviors, are not necessarily independent of one another. For example, both personal activities and pollutant concentrations at a specific

location might vary in response to weather conditions, or between weekdays and weekends.

At a more fundamental level, three types of variability can be distinguished:

- Variability across locations (Spatial Variability);
- Variability over time (Temporal Variability); and
- Variability among individuals (Inter-individual Variability).

**Spatial variability** can occur both at regional (macroscale) and local (microscale) levels. For example, fish intake rates can vary depending on the region of the country. Higher consumption may occur among populations located near large bodies of water such as the Great Lakes or coastal areas. As another example, outdoor pollutant levels can be affected at the regional level by industrial activities and at the local level by activities of individuals. In general, higher exposures tend to be associated with closer proximity to the pollutant source, whether it be an industrial plant or related to a personal activity such as showering or gardening. In the context of exposure to airborne pollutants, the concept of a "microenvironment" has been introduced (Duan, 1982) to denote a specific locality (e.g., a residential lot or a room in a specific building) where the airborne concentration can be treated as homogeneous (i.e., invariant) at a particular point in time.

**Temporal variability** refers to variations over time, whether long- or short-term. Seasonal fluctuations in weather, pesticide applications, use of woodburning appliances and fraction of time spent outdoors are examples of longer-term variability. Examples of shorter-term variability are differences in industrial or personal activities on weekdays versus weekends or at different times of the day.

**Inter-individual variability** can be either of two types: (1) human characteristics such as age or body weight, and (2) human behaviors such as location and activity patterns. Each of these variabilities, in turn, may be related to several underlying phenomena that vary. For example, the natural variability in human weight is due to a combination of genetic, nutritional, and other lifestyle or environmental factors. Variability arising from independent factors that combine multiplicatively generally will lead to an approximately lognormal distribution across the population, or across spatial/temporal dimensions.

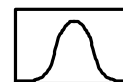

**2.3. CONFRONTING VARIABILITY**

According to the National Research Council (NRC 1994), variability can be confronted in four basic ways (Table 2-1) when dealing with science-policy questions surrounding issues such as exposure or risk assessment. The first is to **ignore the variability** and hope for the best. This strategy tends to work best when the variability is relatively small. For example, the assumption that all adults weigh 70 kg is likely to be correct within  $\pm 25\%$  for most adults.

The second strategy involves **disaggregating the variability** in some explicit way, in order to better understand it or reduce it. Mathematical models are appropriate in some cases, as in fitting a sine wave to the annual outdoor concentration cycle for a particular pollutant and location. In other cases, particularly those involving human characteristics or behaviors, it is easier to disaggregate the data by considering all the relevant subgroups or subpopulations. For example, distributions of body weight could be developed separately for adults, adolescents and children, and even for males and females within each of these subgroups. Temporal and spatial analogies for this concept involve measurements on appropriate time scales and choosing appropriate subregions or microenvironments.

The third strategy is to **use the average value** of a quantity that varies. Although this strategy might appear as tantamount to ignoring variability, it needs to be based

on a decision that the average value can be estimated reliably in light of the variability (e.g., when the variability is known to be relatively small, as in the case of adult body weight).

The fourth strategy involves **using the maximum or minimum value** for an exposure factor. In this case, the variability is characterized by the range between the extreme values and a measure of central tendency. This is perhaps the most common method of dealing with variability in exposure or risk assessment -- to focus on one time period (e.g., the period of peak exposure), one spatial region (e.g., in close proximity to the pollutant source of concern), or one subpopulation (e.g., exercising asthmatics). As noted by the U.S. EPA (1992), when an exposure assessor develops estimates of high-end individual exposure and dose, care must be taken not to set all factors to values that maximize exposure or dose -- such an approach will almost always lead to an overestimate.

**2.4. CONCERN ABOUT UNCERTAINTY**

Why should the exposure assessor be concerned with uncertainty? As noted by the U.S. EPA (1992), exposure assessment can involve a broad array of information sources and analysis techniques. Even in situations where actual exposure-related measurements exist, assumptions or inferences will still be required because data are not likely to be available for all aspects of the exposure assessment. Moreover, the data that are available may be of questionable or unknown quality. Thus, exposure assessors have a responsibility to present not just numbers, but also a clear and explicit explanation of the implications and limitations of their analyses.

Table 2-1. Four Strategies for Confronting Variability		
Strategy	Example	Comment
Ignore variability	Assume that all adults weigh 70 kg	Works best when variability is small
Disaggregate the variability	Develop distributions of body weight for age/gender groups	Variability will be smaller in each group
Use the average value	Use average body weight for adults	Can the average be estimated reliably given what is known about the variability?
Use a maximum or minimum value	Use a lower-end value from the weight distribution	Conservative approach -- can lead to unrealistically high exposure estimate if taken for all factors

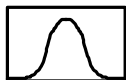

Morgan and Henrion (1990) provide an argument by analogy. When scientists report quantities that they have measured, they are expected to routinely report an estimate of the probable error associated with such measurements. Because uncertainties inherent in policy analysis (of which exposure assessment is a part) tend to be even greater than those in the natural sciences, exposure assessors also should be expected to report or comment on the uncertainties associated with their estimates.

Additional reasons for addressing uncertainty in exposure or risk assessments (U.S. EPA, 1992, Morgan and Henrion, 1990) include the following:

- Uncertain information from different sources of different quality often must be combined for the assessment;
- Decisions need to be made about whether or how to expend resources to acquire additional information,;
- Biases may result in so-called "best estimates" that in actuality are not very accurate; and
- Important factors and potential sources of disagreement in a problem can be identified.

Addressing uncertainty will increase the likelihood that results of an assessment or analysis will be used in an appropriate manner. Problems rarely are solved to everyone's satisfaction, and decisions rarely are reached on the basis of a single piece of evidence. Results of prior analyses can shed light on current assessments, particularly if they are couched in the context of prevailing uncertainty at the time of analysis. Exposure assessment tends to be an iterative process, beginning with a screening-level assessment that may identify the need for more in-depth assessment. One of the primary goals of the more detailed assessment is to reduce uncertainty in estimated exposures. This objective can be achieved more efficiently if guided by presentation and discussion of factors thought to be primarily responsible for uncertainty in prior estimates.

### **2.5. TYPES OF UNCERTAINTY AND REDUCING UNCERTAINTY**

The problem of uncertainty in exposure or risk assessment is relatively large, and can quickly become too complex for facile treatment unless it is divided into smaller and more manageable topics. One method of division (Bogen, 1990) involves classifying sources of uncertainty according to the step in the risk assessment process (hazard identification, dose-response assessment, exposure

assessment or risk characterization) at which they can occur. A more abstract and generalized approach preferred by some scientists is to partition all uncertainties among the three categories of bias, randomness and true variability. These ideas are discussed later in some examples.

The U.S. EPA (1992) has classified uncertainty in exposure assessment into three broad categories:

1. Uncertainty regarding missing or incomplete information needed to fully define exposure and dose (Scenario Uncertainty).
2. Uncertainty regarding some parameter (Parameter Uncertainty).
3. Uncertainty regarding gaps in scientific theory required to make predictions on the basis of causal inferences (Model Uncertainty).

Identification of the sources of uncertainty in an exposure assessment is the first step in determining how to reduce that uncertainty. The types of uncertainty listed above can be further defined by examining their principal causes. Sources and examples for each type of uncertainty are summarized in Table 2-2.

Because uncertainty in exposure assessments is fundamentally tied to a lack of knowledge concerning important exposure factors, strategies for reducing uncertainty necessarily involve reduction or elimination of knowledge gaps. Example strategies to reduce uncertainty include (1) collection of new data using a larger sample size, an unbiased sample design, a more direct measurement method or a more appropriate target population, and (2) use of more sophisticated modeling and analysis tools.

### **2.6. ANALYZING VARIABILITY AND UNCERTAINTY**

Exposure assessments often are developed in a phased approach. The initial phase usually screens out the exposure scenarios or pathways that are not expected to pose much risk, to eliminate them from more detailed, resource-intensive review. Screening-level assessments typically examine exposures that would fall on or beyond the high end of the expected exposure distribution. Because screening-level analyses usually are included in the final exposure assessment, the final document may contain scenarios that differ quite markedly in

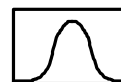

Table 2-2. Three Types of Uncertainty and Associated Sources and Examples

Type of Uncertainty	Sources	Examples
Scenario Uncertainty	Descriptive errors	Incorrect or insufficient information
	Aggregation errors	Spatial or temporal approximations
	Judgment errors	Selection of an incorrect model
	Incomplete analysis	Overlooking an important pathway
Parameter Uncertainty	Measurement errors	Imprecise or biased measurements
	Sampling errors	Small or unrepresentative samples
	Variability	In time, space or activities
	Surrogate data	Structurally-related chemicals
Model Uncertainty	Relationship errors	Incorrect inference on the basis for correlations
	Modeling errors	Excluding relevant variables

sophistication, data quality, and amenability to quantitative expressions of variability or uncertainty.

According to the U.S. EPA (1992), uncertainty characterization and uncertainty assessment are two ways of describing uncertainty at different degrees of sophistication. Uncertainty characterization usually involves a qualitative discussion of the thought processes used to select or reject specific data, estimates, scenarios, etc. Uncertainty assessment is a more quantitative process that may range from simpler measures (e.g., ranges) and simpler analytical techniques (e.g., sensitivity analysis) to more complex measures and techniques. Its goal is to provide decision makers with information concerning the quality of an assessment, including the potential variability in the estimated exposures, major data gaps, and the effect that these data gaps have on the exposure estimates developed.

A distinction between variability and uncertainty was made in Section 2.1. Although the quantitative process mentioned above applies more directly to variability and the qualitative approach more so to uncertainty, there is some degree of overlap. In general, either method provides the assessor or decision-maker with insights to better evaluate the assessment in the context of available data and assumptions. The following paragraphs describe some of the more common procedures for analyzing variability and uncertainty in exposure assessments. Principles that pertain to presenting the results of variability/uncertainty analysis are discussed in the next section.

Several approaches can be used to characterize uncertainty in parameter values. When uncertainty is high,

the assessor may use order-of-magnitude bounding estimates of parameter ranges (e.g., from 0.1 to 10 liters for daily water intake). Another method describes the range for each parameter including the lower and upper bounds as well as a "best estimate" (e.g., 1.4 liters per day) determined by available data or professional judgement.

When sensitivity analysis indicates that a parameter profoundly influences exposure estimates, the assessor should develop a probabilistic description of its range. If there are enough data to support their use, standard statistical methods are preferred. If the data are inadequate, expert judgment can be used to generate a subjective probabilistic representation. Such judgments should be developed in a consistent, well-documented manner. Morgan and Henrion (1990) and Rish (1988) describe techniques to solicit expert judgment.

Most approaches to quantitative analysis examine how variability and uncertainty in values of specific parameters translate into the overall uncertainty of the assessment. Details may be found in reviews such as Cox and Baybutt (1981), Whitmore (1985), Inman and Helton (1988), Seller (1987), and Rish and Marnicio (1988). These approaches can generally be described (in order of increasing complexity and data needs) as: (1) sensitivity analysis; (2) analytical uncertainty propagation; (3) probabilistic uncertainty analysis; or (4) classical statistical methods (U.S. EPA 1992). The four approaches are summarized in Table 2-3.

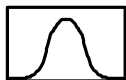

Table 2-3. Approaches to Quantitative Analysis of Uncertainty

Approach	Description	Example
Sensitivity Analysis	Changing one input variable at a time while leaving others constant, to examine effect on output	Fix each input at lower (then upper) bound while holding others at nominal values (e.g., medians)
Analytical Uncertainty Propagation	Examining how uncertainty in individual parameters affects the overall uncertainty of the exposure assessment	Analytically or numerically obtain a partial derivative of the exposure equation with respect to each input parameter
Probabilistic Uncertainty Analysis	Varying each of the input variables over various values of their respective probability distributions	Assign probability density function to each parameter; randomly sample values from each distribution and insert them in the exposure equation (Monte Carlo)
Classical Statistical Methods	Estimating the population exposure distribution directly, based on measured values from a representative sample	Compute confidence interval estimates for various percentiles of the exposure distribution

**2.7. PRESENTING RESULTS OF VARIABILITY AND UNCERTAINTY ANALYSIS**

Comprehensive qualitative analysis and rigorous quantitative analysis are of little value for use in the decision-making process, if their results are not clearly presented. In this chapter, variability (the receipt of different levels of exposure by different individuals) has been distinguished from uncertainty (the lack of knowledge about the correct value for a specific exposure measure or estimate). Most of the data that are presented in this handbook deal with variability directly, through inclusion of statistics that pertain to the distributions for various exposure factors.

Not all approaches historically used to construct measures or estimates of exposure have attempted to distinguish between variability and uncertainty. The assessor is advised to use a variety of exposure descriptors, and where possible, the full population distribution, when presenting the results. This information will provide risk managers with a better understanding of how exposures are distributed over the population and how variability in population activities influences this distribution.

Although incomplete analysis is essentially unquantifiable as a source of uncertainty, it should not be ignored. At a minimum, the assessor should describe the rationale for excluding particular exposure scenarios; characterize the uncertainty in these decisions as high, medium, or low; and state whether they were based on data, analogy, or professional judgment. Where uncertainty is

high, a sensitivity analysis can be used to credible upper limits on exposure by way of a series of "what if" questions.

Although assessors have always used descriptors to communicate the kind of scenario being addressed, the 1992 Exposure Guidelines establish clear quantitative definitions for these risk descriptors. These definitions were established to ensure that consistent terminology is used throughout the Agency. The risk descriptors defined in the Guidelines include descriptors of individual risk and population risk. Individual risk descriptors are intended to address questions dealing with risks borne by individuals within a population, including not only measures of central tendency (e.g., average or median), but also those risks at the high end of the distribution. Population risk descriptors refer to an assessment of the extent of harm to the population being addressed. It can be either an estimate of the number of cases of a particular effect that might occur in a population (or population segment), or a description of what fraction of the population receives exposures, doses, or risks greater than a specified value. The data presented in the Exposure Factors Handbook is one of the tools available to exposure assessors to construct the various risk descriptors.

However, it is not sufficient to merely present the results using different exposure descriptors. Risk managers should also be presented with an analysis of the uncertainties surrounding these descriptors. Uncertainty may be presented using simple or very sophisticated techniques, depending on the requirements of the



assessment and the amount of data available. It is beyond the scope of this handbook to discuss the mechanics of uncertainty analysis in detail. At a minimum, the assessor should address uncertainty qualitatively by answering questions such as:

- What is the basis or rationale for selecting these assumptions/parameters, such as data, modeling, scientific judgment, Agency policy, "what if" considerations, etc.?
- What is the range or variability of the key parameters? How were the parameter values selected for use in the assessment? Were average, median, or upper-percentile values chosen? If other choices had been made, how would the results have differed?
- What is the assessor's confidence (including qualitative confidence aspects) in the key parameters and the overall assessment? What are the quality and the extent of the data base(s) supporting the selection of the chosen values?

Any exposure estimate developed by an assessor will have associated assumptions about the setting, chemical, population characteristics, and how contact with the chemical occurs through various exposure routes and pathways. The exposure assessor will need to examine many sources of information that bear either directly or indirectly on these components of the exposure assessment. In addition, the assessor will be required to make many decisions regarding the use of existing information in constructing scenarios and setting up the exposure equations. In presenting the scenario results, the assessor should strive for a balanced and impartial treatment of the evidence bearing on the conclusions with the key assumptions highlighted. For these key assumptions, one should cite data sources and explain any adjustments of the data.

The exposure assessor also should qualitatively describe the rationale for selection of any conceptual or mathematical models that may have been used. This discussion should address their verification and validation status, how well they represent the situation being assessed (e.g., average versus high-end estimates), and any plausible alternatives in terms of their acceptance by the scientific community.

Table 2-2 summarizes the three types of uncertainty, associated sources, and examples. Table 2-3 summarizes four approaches to analyze uncertainty quantitatively. These are described further in the 1992 Exposure Guidelines.

## **2.8. REFERENCES FOR CHAPTER 2**

- Bogen, K.T. (1990) Uncertainty in environmental health risk assessment. Garland Publishing, New York, NY.
- Cox, D.C.; Baybutt, P.C. (1981) Methods for uncertainty analysis. A comparative survey. *Risk Anal.* 1(4):251-258.
- Duan, N. (1982) Microenvironment types: A model for human exposure to air pollution. *Environ. Intl.* 8:305-309.
- Inman, R.L.; Helton, J.C. (1988) An investigation of uncertainty and sensitivity analysis techniques for computer models. *Risk Anal.* 8(1):71-91.
- Morgan, M.G.; Henrion, M. (1990) Uncertainty: A guide to dealing with uncertainty in quantitative risk and policy analysis. Cambridge University Press, New York, NY.
- National Research Council (NRC). (1994) Science and judgment in risk assessment. National Academy Press, Washington, DC.
- Rish, W.R. (1988) Approach to uncertainty in risk analysis. Oak Ridge National Laboratory. ORNL/TM-10746.
- Rish, W.R.; Marnicio, R.J. (1988) Review of studies related to uncertainty in risk analysis. Oak Ridge National Laboratory. ORNL/TM-10776.
- Seller, F.A. (1987) Error propagation for large errors. *Risk Anal.* 7(4):509-518.
- U.S. EPA (1992) Guidelines for exposure assessment. Washington, DC: Office of Research and Development, Office of Health and Environmental Assessment. EPA/600/2-92/001.
- U.S. EPA (1995) Guidance for risk characterization. Science Policy Council, Washington, DC.
- Whitmore, R.W. (1985) Methodology for characterization of uncertainty in exposure assessments. EPA/600/8-86/009.



3.	DRINKING WATER INTAKE .....	1
3.1.	BACKGROUND .....	1
3.2.	KEY GENERAL POPULATION STUDIES ON DRINKING WATER INTAKE .....	1
3.3.	RELEVANT GENERAL POPULATION STUDIES ON DRINKING WATER INTAKE .....	9
3.4.	PREGNANT AND LACTATING WOMEN .....	17
3.5.	HIGH ACTIVITY LEVELS/HOT CLIMATES .....	20
<b>3.6.</b>	<b>RECOMMENDATIONS</b> .....	<b>23</b>
3.7.	REFERENCES FOR CHAPTER 3 .....	30



### 3. DRINKING WATER INTAKE

#### 3.1. BACKGROUND

Drinking water is a potential source of human exposure to toxic substances. Contamination of drinking water may occur by, for example, percolation of toxics through the soil to ground water that is used as a source of drinking water; runoff or discharge to surface water that is used as a source of drinking water; intentional or unintentional addition of substances to treat water (e.g., chlorination); and leaching of materials from plumbing systems (e.g., lead). Estimating the magnitude of the potential dose of toxics from drinking water requires information on the quantity of water consumed. The purpose of this section is to describe key published studies that provide information on drinking water consumption (Section 3.2) and to provide recommendations of consumption rate values that should be used in exposure assessments (Section 3.6).

Currently, the U.S. EPA uses the quantity of 2 L per day for adults and 1 L per day for infants (individuals of 10 kg body mass or less) as default drinking water intake rates (U.S. EPA, 1980; 1991). These rates include drinking water consumed in the form of juices and other beverages containing tapwater (e.g., coffee). The National Academy of Sciences (NAS, 1977) estimated that daily consumption of water may vary with levels of physical activity and fluctuations in temperature and humidity. It is reasonable to assume that some individuals in physically-demanding occupations or living in warmer regions may have high levels of water intake.

Numerous studies cited in this chapter have generated data on drinking water intake rates. In general, these sources support EPA's use of 2 L/day for adults and 1 L/day for children as upper-percentile tapwater intake rates. Many of the studies have reported fluid intake rates for both total fluids and tapwater. *Total fluid intake* is defined as consumption of all types of fluids including tapwater, milk, soft drinks, alcoholic beverages, and water intrinsic to purchased foods. *Total tapwater* is defined as water consumed directly from the tap as a beverage or used in the preparation of foods and beverages (i.e., coffee, tea, frozen juices, soups, etc.). Data for both consumption categories are presented in the sections that follow. However, for the purposes of exposure assessments involving source-specific contaminated drinking water, intake rates based on total tapwater are more representative of source-specific tapwater intake. Given the assumption that purchased foods and beverages are widely distributed and less likely to contain source-specific water, the use of total fluid intake

rates may overestimate the potential exposure to toxic substances present only in local water supplies; therefore tapwater intake, rather than total fluid intake, is emphasized in this section.

All studies on drinking water intake that are currently available are based on short-term survey data. Although short-term data may be suitable for obtaining mean intake values that are representative of both short- and long-term consumption patterns, upper-percentile values may be different for short-term and long-term data because more variability generally occurs in short-term surveys. It should also be noted that most drinking water surveys currently available are based on recall. This may be a source of uncertainty in the estimated intake rates because of the subjective nature of this type of survey technique.

The distribution of water intakes is usually, but not always, lognormal. Instead of presenting only the lognormal parameters, the actual percentile distributions are presented in this handbook, usually with a comment on whether or not it is lognormal. To facilitate comparisons between studies, the mean and the 90th percentiles are given for all studies where the distribution data are available. With these two parameters, along with information about which distribution is being followed, one can calculate, using standard formulas, the geometric mean and geometric standard deviation and hence any desired percentile of the distribution. Before doing such a calculation one must be sure that one of these distributions adequately fits the data.

The available studies on drinking water consumption are summarized in the following sections. They have been classified as either key studies or relevant studies based on the applicability of their survey designs to exposure assessment of the entire United States population. Recommended intake rates are based on the results of key studies, but relevant studies are also presented to provide the reader with added perspective on the current state-of-knowledge pertaining to drinking water intake.

#### 3.2. KEY GENERAL POPULATION STUDIES ON DRINKING WATER INTAKE

*Canada Department of Health and Welfare (1981) - Tapwater Consumption in Canada* - In a study conducted by the Canadian Department of Health and Welfare, 970 individuals from 295 households were surveyed to



determine the per capita total tapwater intake rates for various age/sex groups during winter and summer seasons (Canadian Ministry of National Health and Welfare, 1981). Intake rate was also evaluated as a function of physical activity. The population that was surveyed matched the Canadian 1976 census with respect to the proportion in different age, regional, community size and dwelling type

at home and tapwater consumed away from home. The survey also did not attempt to estimate intake rates for fluids other than tapwater. Consequently, no intake rates for total fluids were reported.

Daily consumption distribution patterns for various age groups are presented in Table 3-1. For adults (over 18 years of age) only, the average total tapwater intake rate was

Table 3-1. Daily Total Tapwater Intake Distribution for Canadians, by Age Group (approx. 0.20 L increments, both sexes, combined seasons)

Amount Consumed <sup>a</sup> L/day	Age Group (years)					
	5 and under		6-17		18 and over	
	%	Number	%	Number	%	Number
0.00 - 0.21	11.1	9	2.8	7	0.5	3
0.22 - 0.43	17.3	14	10.0	25	1.9	12
0.44 - 0.65	24.8	20	13.2	33	5.9	38
0.66 - 0.86	9.9	8	13.6	34	8.5	54
0.87 - 1.07	11.1	9	14.4	36	13.1	84
1.08 - 1.29	11.1	9	14.8	37	14.8	94
1.30 - 1.50	4.9	4	9.6	24	15.3	98
1.51 - 1.71	6.2	5	6.8	17	12.1	77
1.72 - 1.93	1.2	1	2.4	6	6.9	44
1.94 - 2.14	1.2	1	1.2	3	5.6	36
2.15 - 2.36	1.2	1	4.0	10	3.4	22
2.37 - 2.57	-	0	0.4	1	3.1	20
2.58 - 2.79	-	0	2.4	6	2.7	17
2.80 - 3.00	-	0	2.4	6	1.4	9
3.01 - 3.21	-	0	0.4	1	1.1	7
3.22 - 3.43	-	0	-	0	0.9	6
3.44 - 3.64	-	0	-	0	0.8	5
3.65 - 3.86	-	0	-	0	-	0
>3.86	-	0	1.6	4	2.0	13
TOTAL	100.0	81	100.0	250	100.0	639

<sup>a</sup> Includes tapwater and foods and beverages derived from tapwater.  
Source: Canadian Ministry of National Health and Welfare, 1981.

groups. Participants monitored water intake for a 2-day period (1 weekday, and 1 weekend day) in both late summer of 1977 and winter of 1978. All 970 individuals participated in both the summer and winter surveys. The amount of tapwater consumed was estimated based on the respondents' identification of the type and size of beverage container used, compared to standard sized vessels. The survey questionnaires included a pictorial guide to help participants in classifying the sizes of the vessels. For example, a small glass of water was assumed to be equivalent to 4.0 ounces of water, and a large glass was assumed to contain 9.0 ounces of water. The study also accounted for water derived from ice cubes and popsicles, and water in soups, infant formula, and juices. The survey did not attempt to differentiate between tapwater consumed

1.38 L/day, and the 90th percentile rate was 2.41 L/day as determined by graphical interpolation. These data follow a lognormal distribution. The intake data for males, females, and both sexes combined as a function of age and expressed in the units of milliliters (grams) per kilogram body weight are presented in Table 3-2. The tapwater survey did not include body weights of the participants, but the body weight information was taken from a Canadian health survey dated 1981; it averaged 65.1 kg for males and 55.6 kg for females. Intake rates for specific age groups and seasons are presented in Table 3-3. The average daily total tapwater intake rates for all ages and seasons combined was 1.34 L/day, and the 90th percentile rate was 2.36 L/day. The summer intake rates are nearly the same as the winter intake rates. The authors speculate that the reason for the



Chapter 3 - Drinking Water Intake

small seasonal variation here is that in Canada, even in the summer, the ambient temperature seldom exceeded 20 degrees C and marked increase in water consumption with high activity levels has been observed in other studies only when the ambient temperature has been higher than 20 degrees. Average daily total tapwater intake rates as a function of the level of physical activity, as estimated subjectively, are presented in Table 3-4. The amounts of tapwater consumed that are derived from various foods and beverages are presented in Table 3-5. Note that the consumption of direct “raw” tapwater is almost constant across all age groups from school-age children through the oldest ages. The increase in total tapwater consumption beyond school age is due to coffee and tea consumption.

Table 3-2. Average Daily Tapwater Intake of Canadians (expressed as milliliters per kilogram body weight)

Age Group (years)	Average Daily Intake (mL/kg)		
	Females	Males	Both Sexes
<3	53	35	45
3-5	49	48	48
6-17	24	27	26
18-34	23	19	21
35-54	25	19	22
55+	24	21	22
Total Population	24	21	22

Source: Canadian Ministry of National Health and Welfare, 1981.

Table 3-3. Average Daily Total Tapwater Intake of Canadians, by Age and Season (L/day)<sup>a</sup>

	Age (years)						
	<3	3-5	6-17	18-34	35-54	≤55	All Ages
<u>Average</u>							
Summer	0.57	0.86	1.14	1.33	1.52	1.53	1.31
Winter	0.66	0.88	1.13	1.42	1.59	1.62	1.37
Summer/Winter	0.61	0.87	1.14	1.38	1.55	1.57	1.34
<u>90th Percentile</u>							
Summer/Winter	1.50	1.50	2.21	2.57	2.57	2.29	2.36

<sup>a</sup> Includes tapwater and foods and beverages derived from tapwater.  
Source: Canadian Ministry of National Health and Welfare, 1981.

Table 3-4. Average Daily Total Tapwater Intake of Canadians as a Function of Level of Physical Activity at Work and in Spare Time (16 years and older, combined seasons, L/day)

Activity Level <sup>a</sup>	Work		Spare Time	
	Consumption <sup>b</sup> L/day	Number of Respondents	Consumption <sup>b</sup> L/day	Number of Respondents
Extremely Active	1.72	99	1.57	52
Very Active	1.47	244	1.51	151
Somewhat Active	1.47	217	1.44	302
Not Very Active	1.27	67	1.52	131
Not At All Active	1.30	16	1.35	26
Did Not State	1.30	<u>45</u>	1.31	<u>26</u>
TOTAL		688		688

<sup>a</sup> The levels of physical activity listed here were not defined any further by the survey report, and categorization of activity level by survey participants is assumed to be subjective.  
<sup>b</sup> Includes tapwater and foods and beverages derived from tapwater.  
Source: Canadian Ministry of National Health and Welfare, 1981.

Table 3-5. Average Daily Tapwater Intake by Canadians, Apportioned Among Various Beverages (both sexes, by age, combined seasons, L/day)<sup>a</sup>



	Age Group (years)					
	Under 3	3-5	6-17	18-34	35-54	55 and Over
Total Number in Group 34	47	250	232	254	153	
Water	0.14	0.31	0.42	0.39	0.38	0.38
Ice/Mix	0.01	0.01	0.02	0.04	0.03	0.02
Tea	*	0.01	0.05	0.21	0.31	0.42
Coffee	0.01	*	0.06	0.37	0.50	0.42
"Other Type of Drink"	0.21	0.34	0.34	0.20	0.14	0.11
Reconstituted Milk	0.10	0.08	0.12	0.05	0.04	0.08
Soup	0.04	0.08	0.07	0.06	0.08	0.11
Homemade Beer/Wine	*	*	0.02	0.04	0.07	0.03
Homemade Popsicles	0.01	0.03	0.03	0.01	*	*
Baby Formula, etc.	0.09	*	*	*	*	*
<b>TOTAL</b>	<b>0.61</b>	<b>0.86</b>	<b>1.14</b>	<b>1.38</b>	<b>1.55</b>	<b>1.57</b>
<sup>a</sup>	Includes tapwater and foods and beverages derived from tapwater.					
*	Less than 0.01 L/day					
Source: Canadian Ministry of National Health and Welfare, 1981.						

Data concerning the source of tapwater (municipal, well, or lake) was presented in one table of the study. This categorization is not appropriate for making conclusions about consumption of ground versus surface water.

This survey may be more representative of total tapwater consumption than some other less comprehensive surveys because it included data for some tapwater-containing items not covered by other studies (i.e., ice cubes, popsicles, and infant formula). One potential source of error in the study is that estimated intake rates were based on identification of standard vessel sizes; the accuracy of this type of survey data is not known. The cooler climate of Canada may have reduced the importance of large tapwater intakes resulting from high activity levels, therefore making the study less applicable to the United States. The authors were not able to explain the surprisingly large variations between regional tapwater intakes; the largest regional difference was between Ontario (1.18 liters/day) and Quebec (1.55 liters/day).

*Ershow and Cantor (1989) - Total Water and Tapwater Intake in the United States: Population-Based Estimates of Quantities and Sources* - Ershow and Cantor (1989) estimated water intake rates based on data collected by the USDA 1977-1978 Nationwide Food Consumption Survey (NFCS). Daily intake rates for tapwater and total water were calculated for various age groups for males, females, and both sexes combined. Tapwater was defined

as "all water from the household tap consumed directly as a beverage or used to prepare foods and beverages." Total water was defined as tapwater plus "water intrinsic to foods and beverages" (i.e., water contained in purchased food and beverages). The authors showed that the age, sex, and racial distribution of the surveyed population closely matched the estimated 1977 U. S. population.

Daily total tapwater intake rates, expressed as mL (grams) per day by age group are presented in Table 3-6. These data follow a lognormal distribution. The same data, expressed as mL (grams) per kg body weight per day are presented in Table 3-7. A summary of these tables, showing the mean, the 10th and 90th percentile intakes, expressed as both mL/day and mL/kg-day as a function of age, is presented in Table 3-8. This shows that the mean and 90th percentile intake rates for adults (ages 20 to 65+) are approximately 1,410 mL/day and 2,280 mL/day and for all ages the mean and 90th percentile intake rates are 1,190 mL/day and 2,090 mL/day. Note that older adults have greater intakes than do adults between age 20 and



Table 3-6. Total Tapwater Intake (mL/day) for Both Sexes Combined<sup>a</sup>

Age (years)	Number of Observations	Mean	SD	S.E. of Mean	Percentile Distribution								
					1	5	10	25	50	75	90	95	99
<0.5	182	272	247	18	*	0	0	80	240	332	640	800	*
0.5 - 0.9	221	328	265	18	*	0	0	117	268	480	688	764	*
1 - 3	1498	646	390	10	33	169	240	374	567	820	1162	1419	1899
4 - 6	1702	742	406	10	68	204	303	459	660	972	1302	1520	1932
7 - 10	2405	787	417	9	68	241	318	484	731	1016	1338	1556	1998
11 - 14	2803	925	521	10	76	244	360	561	838	1196	1621	1924	2503
15 - 19	2998	999	593	11	55	239	348	587	897	1294	1763	2134	2871
20 - 44	7171	1255	709	8	105	337	483	766	1144	1610	2121	2559	3634
45 - 64	4560	1546	723	11	335	591	745	1057	1439	1898	2451	2870	3994
65 - 74	1663	1500	660	16	301	611	766	1044	1394	1873	2333	2693	3479
75+	878	1381	600	20	279	568	728	961	1302	1706	2170	2476	3087
Infants (ages <1)	403	302	258	13	0	0	0	113	240	424	649	775	1102
Children (ages 1-10)	5605	736	410	5	56	192	286	442	665	960	1294	1516	1954
Teens (ages 11-19)	5801	965	562	7	67	240	353	574	867	1246	1701	2026	2748
Adults (ages 20-64)	11731	1366	728	7	148	416	559	870	1252	1737	2268	2707	3780
Adults (ages 65+)	2541	1459	643	13	299	598	751	1019	1367	1806	2287	2636	3338
All	26081	1193	702	4	80	286	423	690	1081	1561	2092	2477	3415

<sup>a</sup> Total tapwater is defined as "all water from the household tap consumed directly as a beverage or used to prepare foods and beverages."

\* Value not reported due to insufficient number of observations.

Source: Ershow and Cantor, 1989.

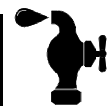

Table 3-7. Total Tapwater Intake (mL/kg-day) for Both Sexes Combined<sup>a</sup>

Age (years)	Number of Observations		Mean	SD	S.E. of Mean	1	5	10	25	50	75	90	95	99
	Actual Count	Weighted Count												
<0.5	182	201.2	52.4	53.2	3.9	*	0.0	0.0	14.8	37.8	66.1	128.3	155.6	*
0.5 - 0.9	221	243.2	36.2	29.2	2.0	*	0.0	0.0	15.3	32.2	48.1	69.4	102.9	*
1 - 3	1498	1687.7	46.8	28.1	0.7	2.7	11.8	17.8	27.2	41.4	60.4	82.1	101.6	140.6
4 - 6	1702	1923.9	37.9	21.8	0.5	3.4	10.3	14.9	21.9	33.3	48.7	69.3	81.1	103.4
7 - 10	2405	2742.4	26.9	15.3	0.3	2.2	7.4	10.3	16.0	24.0	35.5	47.3	55.2	70.5
11 - 14	2803	3146.9	20.2	11.6	0.2	1.5	4.9	7.5	11.9	18.1	26.2	35.7	41.9	55.0
15 - 19	2998	3677.9	16.4	9.6	0.2	1.0	3.9	5.7	9.6	14.8	21.5	29.0	35.0	46.3
20 - 44	7171	13444.5	18.6	10.7	0.1	1.6	4.9	7.1	11.2	16.8	23.7	32.2	38.4	53.4
45 - 64	4560	8300.4	22.0	10.8	0.2	4.4	8.0	10.3	14.7	20.2	27.2	35.5	42.1	57.8
65 - 74	1663	2740.2	21.9	9.9	0.2	4.6	8.7	10.9	15.1	20.2	27.2	35.2	40.6	51.6
75+	878	1401.8	21.6	9.5	0.3	3.8	8.8	10.7	15.0	20.5	27.1	33.9	38.6	47.2
Infants (ages <1)	403	444.3	43.5	42.5	2.1	0.0	0.0	0.0	15.3	35.3	54.7	101.8	126.5	220.5
Children (ages 1-10)	5605	6354.1	35.5	22.9	0.3	2.7	8.3	12.5	19.6	30.5	46.0	64.4	79.4	113.9
Teens (ages 11-19)	5801	6824.9	18.2	10.8	0.1	1.2	4.3	6.5	10.6	16.3	23.6	32.3	38.9	52.6
Adults (ages 20-64)	11731	21744.9	19.9	10.8	0.1	2.2	5.9	8.0	12.4	18.2	25.3	33.7	40.0	54.8
Adults (ages 65+)	2541	4142.0	21.8	9.8	0.2	4.5	8.7	10.9	15.0	20.3	27.1	34.7	40.0	51.3
All	26081	39510.2	22.6	15.4	0.1	1.7	5.8	8.2	13.0	19.4	28.0	39.8	50.0	79.8

<sup>a</sup> Total tapwater is defined as "all water from the household tap consumed directly as a beverage or used to prepare foods and beverages."

\* Value not reported due to insufficient number of observations.

Source: Ershow and Cantor, 1989.



Table 3-8. Summary of Tapwater Intake by Age

Age Group	Intake (mL/day)		Intake (mL/kg-day)	
	Mean	10th-90th Percentiles	Mean	10th-90th Percentiles
Infants (<1 year)	302	0-649	43.5	0 - 100
Children (1-10 years)	736	286-1,294	35.5	12.5 - 64.4
Teens (11-19 years)	965	353-1,701	18.2	6.5 - 32.3
Adults (20 -64 years)	1,366	559-2,268	19.9	8.0 - 33.7
Adults (65+ years)	1,459	751-2,287	21.8	10.9 - 34.7
All ages	1,193	423-2,092	22.6	8.2 - 39.8

Source: Ershow and Cantor (1989)

65, an observation bearing on the interpretation of the Cantor, et al. (1987) study which surveyed a population that was older than the national average (see Section 3.3).

Ershow and Cantor (1989) also measured total water intake for the same age groups and concluded that it averaged 2,070 mL/day for all groups combined and that tapwater intake (1,190 mL/day) is 55 percent of the total water intake. (The detailed intake data for various age groups are presented in Table 3-9). Ershow and Cantor (1989) also concluded that, for all age groups combined, the proportion of tapwater consumed as drinking water, foods, and beverages is 54 percent, 10 percent and 36 percent, respectively. (The detailed data on proportion of tapwater consumed for various age groups are presented in Table 3-10). Ershow and Cantor (1989) also observed that males of all age groups had higher total water and tapwater consumption rates than

females; the variation of each from the combined-sexes mean was about 8 percent.

Ershow and Cantor (1989) also presented data on total water intake and tapwater intake for children of various ages. They found, for infants and children between the ages of 6 months and 15 years, that the total water intake per unit body weight increased smoothly and sharply from 30 mL/kg-day above age 15 years to 190 mL/kg-day for ages less than 6 months. This probably represents metabolic requirements for water as a dietary constituent. However, they found that the intake of tapwater alone went up only slightly with decreasing age (from 20 to 45 mL/kg-day as age decreases from 11 years to less than 6 months). Ershow and Cantor (1989) attributed this small effect of age on tapwater intake to the large number of alternative water sources (besides tapwater) used for the younger age groups.

Table 3-9. Total Tapwater Intake (as percent of total water intake) by Broad Age Category<sup>a,b</sup>

Age (years)	Mean	Percentile Distribution								
		1	5	10	25	50	75	90	95	99
<1	26	0	0	0	12	22	37	55	62	82
1-10	45	6	19	24	34	45	57	67	72	81
11-19	47	6	18	24	35	47	59	69	74	83
20-64	59	12	27	35	49	61	72	79	83	90
65+	65	25	41	47	58	67	74	81	84	90

<sup>a</sup> Does not include pregnant women, lactating women, or breast-fed children.  
<sup>b</sup> Total tapwater is defined as "all water from the household tap consumed directly as a beverage or used to prepare foods and beverages."  
 0 = Less than 0.5 percent.

Source: Ershow and Cantor, 1989.





Table 3-10. General Dietary Sources of Tapwater for Both Sexes<sup>a,b</sup>

Age (years)	Source	% of Tapwater							
		Mean	Standard Deviation	5	25	50	75	95	99
<1	Food <sup>c</sup>	11	24	0	0	0	10	70	100
	Drinking Water	69	37	0	39	87	100	100	100
	Other Beverages	20	33	0	0	0	22	100	100
	All Sources	100							
1-10	Food <sup>c</sup>	15	16	0	5	10	19	44	100
	Drinking Water	65	25	0	52	70	84	96	100
	Other Beverages	20	21	0	0	15	32	63	93
	All Sources	100							
11-19	Food <sup>c</sup>	13	15	0	3	8	17	38	100
	Drinking Water	65	25	0	52	70	85	98	100
	Other Beverages	22	23	0	0	16	34	68	96
	All Sources	100							
20-64	Food <sup>c</sup>	8	10	0	2	5	11	25	49
	Drinking Water	47	26	0	29	48	67	91	100
	Other Beverages	45	26	0	25	44	63	91	100
	All Sources	100							
65+	Food <sup>c</sup>	8	9	0	2	5	11	23	38
	Drinking Water	50	23	0	36	52	66	87	99
	Other Beverages	42	23	3	27	40	57	85	100
	All Sources	100							
All	Food <sup>c</sup>	10	13	0	2	6	13	31	64
	Drinking Water	54	27	0	36	56	75	95	100
	Other Beverages	36	27	0	14	34	55	87	100
	All Sources	100							

<sup>a</sup> Does not include pregnant women, lactating women, or breast-fed children.  
<sup>b</sup> Individual values may not add to totals due to rounding.  
<sup>c</sup> Food category includes soups.  
0 = Less than 0.5 percent.  
Source: Ershow and Cantor, 1989.

With respect to region of the country, the northeast states had slightly lower average tapwater intake (1,200 mL/day) than the three other regions (which were approximately equal at 1,400 mL/day).

This survey has an adequately large size (26,446 individuals) and it is a representative sample of the United States population with respect to age distribution, sex, racial composition, and residential location. It is therefore suitable as a description of national tapwater consumption. The chief limitation of the study is that the data were collected in 1978 and do not reflect the expected increase in the consumption of soft drinks and bottled water or changes in the diet within the last two decades. Since the data were

collected for only a three-day period, the extrapolation to chronic intake is uncertain.

*Roseberry and Burmaster (1992) - Lognormal Distributions for Water Intake* - Roseberry and Burmaster (1992) fit lognormal distributions to the water intake data reported by Ershow and Cantor (1989) and estimated population-wide distributions for total fluid and total tapwater intake based on proportions of the population in each age group. Their publication shows the data and the fitted log-normal distributions graphically. The mean was estimated as the zero intercept, and the standard deviation was estimated as the slope of the best fit line for the natural logarithm of the intake rates plotted against their



Chapter 3 - Drinking Water Intake

corresponding z-scores (Roseberry and Burmaster, 1992). Least squares techniques were used to estimate the best fit straight lines for the transformed data. Summary statistics for the best-fit lognormal distribution are presented in Table 3-11. In this table, the simulated balanced population represents an adjustment to account for the different age distribution of the United States population in 1988 from the age distribution in 1978 when Ershow and Cantor (1989) collected their data. Table 3-12 summarizes the quantiles and means of tapwater intake as estimated from the best-fit distributions. The mean total tapwater intake rates for the two adult populations (age 20 to 65 years, and 65+ years) were estimated to be 1.27 and 1.34 L/day.

These intake rates were based on the data originally presented by Ershow and Cantor (1989). Consequently, the same advantages and disadvantages associated with the Ershow and Cantor (1989) study apply to this data set.

3.3. RELEVANT GENERAL POPULATION STUDIES ON DRINKING WATER INTAKE

*National Academy of Sciences (1977) - Drinking Water and Health* - NAS (1977) calculated the average per capita water (liquid) consumption per day to be 1.63 L. This figure was based on a survey of the following literature sources: Evans (1941); Bourne and Kidder (1953); Walker et al. (1957); Wolf (1958); Guyton (1968); McNall and Schlegel (1968); Randall (1973); NAS (1974); and Pike and Brown (1975). Although the calculated average intake rate was 1.63 L per day, NAS (1977) adopted a larger rate (2 L per day) to represent the intake of the majority of water consumers. This value is relatively consistent with the total tapwater intakes rate estimated from the key studies presented previously. However, the use of the term "liquid" was not clearly defined in this study, and it is not known whether the populations surveyed are representative of the adult U.S. population. Consequently, the results of this study are of limited use in recommending total tapwater intake rates and this study is not considered a key study.

*Hopkins and Ellis (1980) - Drinking Water Consumption in Great Britain* - A study conducted in Great Britain over a 6-week period during September and October 1978, estimated the drinking water consumption rates of 3,564 individuals from 1,320 households in England, Scotland, and Wales (Hopkins and Ellis, 1980). The participants were selected randomly and were asked to complete a questionnaire and a diary indicating the type and quantity of beverages consumed over a 1-week period. Total liquid intake included total tapwater taken at home and away from home; purchased alcoholic beverages; and non-tapwater-based drinks. Total tapwater included water content of tea, coffee, and other hot water drinks; homemade alcoholic beverages; and tapwater consumed directly as a beverage. The assumed tapwater contents for these beverages are presented in Table 3-13. Based on responses from 3,564 participants, the mean intake rates and frequency distribution data for various beverage categories were estimated by Hopkins and Ellis (1980). These data are listed in Table 3-14. The mean per capita total liquid intake rate for all individuals surveyed was 1.59 L/day, and the mean per capita total tapwater intake rate was 0.95 L/day, with a 90th percentile

Table 3-11. Summary Statistics for Best-Fit Lognormal Distributions for Water Intake Rates<sup>a</sup>

Group (age in years)	In Total Fluid Intake Rate		R <sup>2</sup>
	$\mu$	$\sigma$	
0 < age <1	6.979	0.291	0.996
1 ≤ age <11	7.182	0.340	0.953
11 ≤ age <20	7.490	0.347	0.966
20 ≤ age <65	7.563	0.400	0.977
65 ≤ age	7.583	0.360	0.988
All ages	7.487	0.405	0.984
Simulated balanced population	7.492	0.407	1.000

Group (age in years)	In Total Tapwater Intake		R <sup>2</sup>
	$\mu$	$\sigma$	
0 < age <1	5.587	0.615	0.970
1 ≤ age <11	6.429	0.498	0.984
11 ≤ age <20	6.667	0.535	0.986
20 ≤ age <65	7.023	0.489	0.956
65 ≤ age	7.088	0.476	0.978
All ages	6.870	0.530	0.978
Simulated balanced population	6.864	0.575	0.995

<sup>a</sup> These values (mL/day) were used in the following equations to estimate the quantiles and averages for total tapwater intake shown in Tables 3-12.

97.5 percentile intake rate =  $\exp [\mu + (1.96 \cdot \sigma)]$   
 75 percentile intake rate =  $\exp [\mu + (0.6745 \cdot \sigma)]$   
 50 percentile intake rate =  $\exp [\mu]$   
 25 percentile intake rate =  $\exp [\mu - (0.6745 \cdot \sigma)]$   
 2.5 percentile intake rate =  $\exp [\mu - (1.96 \cdot \sigma)]$   
 Mean intake rate =  $\exp [\mu + 0.5 \cdot \sigma^2]$   
 Source: Roseberry and Burmaster, 1992.



Table 3-12. Estimated Quantiles and Means for Total Tapwater Intake Rates (mL/day)<sup>a</sup>

Age Group (years)	Percentile					Arithmetic Average
	2.5	25	50	75	97.5	
0 < age < 1	80	176	267	404	891	323
1 ≤ age < 11	233	443	620	867	1,644	701
11 ≤ age < 20	275	548	786	1,128	2,243	907
20 ≤ age < 65	430	807	1,122	1,561	2,926	1,265
65 ≤ age	471	869	1,198	1,651	3,044	1,341
All ages	341	674	963	1,377	2,721	1,108
Simulated Balanced Population	310	649	957	1,411	2,954	1,129

<sup>a</sup> Total tapwater is defined as "all water from the household tap consumed directly as a beverage or used to prepare foods and beverages."  
Source: Roseberry and Burmaster, 1992

Table 3-13. Assumed Tapwater Content of Beverages

Beverage	% Tapwater
Cold Water	100
Home-made Beer/Cider/Lager	100
Home-made Wine	100
Other Hot Water Drinks	100
Ground/Instant Coffee: <sup>a</sup>	
Black	100
White	80
Half Milk	50
All Milk	0
Tea	80
Hot Milk	0
Cocoa/Other Hot Milk Drinks	0
Water-based Fruit Drink	75
Fizzy Drinks	0
Fruit Juice 1 <sup>b</sup>	0
Fruit Juice 2 <sup>b</sup>	75
Milk	0
Mineral Water <sup>c</sup>	0
Bought cider/beer/lager	0
Bought Wine	0

<sup>a</sup> Black - coffee with all water, milk not added; White - coffee with 80% water, 20% milk; Half Milk - coffee with 50% water, 50% milk; All Milk - coffee with all milk, water not added;  
<sup>b</sup> Fruit juice: individuals were asked in the questionnaire if they consumed ready-made fruit juice (type 1 above), or the variety that is diluted (type 2);  
<sup>c</sup> Information on volume of mineral water consumed was obtained only as "number of bottles per week." A bottle was estimated at 500 mL, and the volume was split so that 2/7 was assumed to be consumed on weekends, and 5/7 during the week.  
Source: Hopkins and Ellis, 1980.

respectively, 1.07 L/day and 1.87 L/day, as determined by pooling data for males and females for the three adult age ranges in Table 3-15. This calculation assumes, as does Table 3-14 and 3-15, that the underlying distribution is normal and not lognormal.

The advantage of using these data is that the responses were not generated on a recall basis, but by recording daily intake in diaries. The latter approach may result in more accurate responses being generated. Also, the use of total liquid and total tapwater was well defined in this study. However, the relatively short-term nature of the survey make extrapolation to long-term consumption patterns difficult. Also, these data were based on the population of Great Britain and not the United States. Drinking patterns may differ among these populations as a result of varying weather conditions and socio-economic factors. For these reasons this study is not considered a key study in this document.

*International Commission on Radiological Protection (ICRP) (1981) - Report to the Task Group on Reference Man* - Data on fluid intake levels have also been summarized by the International Commission on Radiological Protection (ICRP) in the Report of the Task Group on Reference Man (ICRP, 1981). These intake levels for adults and children are summarized in Table 3-16. The amount of drinking water (tapwater and water-based drinks) consumed by adults ranged from about 0.37 L/day to about 2.18 L/day under "normal" conditions. The levels for children ranged from 0.54 to 0.79 L/day. Because the populations, survey design, and intake categories are not clearly defined, this study has limited usefulness in developing recommended intake rates for use in exposure assessment. It is reported here as a relevant study because the findings, although poorly defined, are consistent with the results of other studies.

value of about 1.3 L/day (which is the value of the percentile for the home tapwater alone in Table 3-14). Liquid intake rates were also estimated for males and females in various age groups. Table 3-15 summarizes the total liquid and total tapwater intake rates for 1,758 males and 1,800 females grouped into six age categories (Hopkins and Ellis, 1980). The mean and 90th percentile total tapwater intake values for adults over age 18 years are,



Table 3-14. Intake of Total Liquid, Total Tapwater, and Various Beverages (L/day)

Beverage	All Individuals					Consumers Only			
	Mean Intake	Approx. Std. Error of Mean	Approx. 95% Confidence Interval for Mean	10 and 90 Percentiles	1 and 99 Percentiles	Percentage of Total Number of Individuals	Mean Intake	Approx. Std. Error of Mean	Approx. 95% Confidence Interval for Mean
Total Liquid	1.589	0.0203	1.547-1.629	0.77-2.57	0.34-4.50	100.0	1.589	0.0203	1.547-1.629
Total Liquid Home	1.104	0.0143	1.075-1.133	0.49-1.79	0.23-3.10	100.0	1.104	0.0143	1.075-1.133
Total Liquid Away	0.484	0.0152	0.454-0.514	0.00-1.15	0.00-2.89	89.9	0.539	0.0163	0.506-0.572
Total Tapwater	0.955	0.0129	0.929-0.981	0.39-1.57	0.10-2.60	99.8	0.958	0.0129	0.932-0.984
Total Tapwater Home	0.754	0.0116	0.731-0.777	0.26-1.31	0.02-2.30	99.4	0.759	0.0116	0.736-0.782
Total Tapwater Away	0.201	0.0056	0.190-0.212	0.00-0.49	0.00-0.96	79.6	0.253	0.0063	0.240-0.266
Tea	0.584	0.0122	0.560-0.608	0.01-1.19	0.00-2.03	90.9	0.643	0.0125	0.618-0.668
Coffee	0.190	0.0059	0.178-0.202	0.00-0.56	0.00-1.27	63.0	0.302	0.0105	0.281-0.323
Other Hot Water Drinks	0.011	0.0015	0.008-0.014	0.00-0.00	0.00-0.25	9.2	0.120	0.0133	0.093-0.147
Cold Water	0.103	0.0049	0.093-0.113	0.00-0.31	0.00-0.85	51.0	0.203	0.0083	0.186-0.220
Fruit Drinks	0.057	0.0027	0.052-0.062	0.00-0.19	0.00-0.49	46.2	0.123	0.0049	0.113-0.133
Non Tapwater	0.427	0.0058	0.415-0.439	0.20-0.70	0.06-1.27	99.8	0.428	0.0058	0.416-0.440
Home-brew	0.010	0.0017	0.007-0.013	0.00-0.00	0.00-0.20	7.0	0.138	0.0209	0.096-0.180
Bought Alcoholic Beverages	0.206	0.0123	0.181-0.231	0.00-0.68	0.00-2.33	43.5	0.474	0.0250	0.424-0.524

<sup>a</sup> Consumers only is defined as only those individuals who reported consuming the beverage during the survey period.  
Source: Hopkin and Ellis, 1980.



Table 3-15. Summary of Total Liquid and Total Tapwater Intake for Males and Females (L/day)

Beverage	Age Group (years)	Number		Mean Intake		Approx. Std. Error of Mean		Approx 95% Confidence Interval for Mean		10 and 90 Percentiles	
		Male	Female	Male	Female	Male	Female	Male	Female	Male	Female
Total Liquid Intake	1-4	88	75	0.853	0.888	0.0557	0.0660	0.742-0.964	0.756-1.020	0.38-1.51	0.39-1.48
	5-11	249	201	0.986	0.902	0.0296	0.0306	0.917-1.045	0.841-0.963	0.54-1.48	0.51-1.39
	12-17	180	169	1.401	1.198	0.0619	0.0429	1.277-1.525	1.112-1.284	0.75-2.27	0.65-1.74
	18-30	333	350	2.184	1.547	0.0691	0.0392	2.046-2.322	1.469-1.625	1.12-3.49	0.93-2.30
	31-54	512	551	2.112	1.601	0.0526	0.0215	2.007-2.217	1.558-1.694	1.15-3.27	0.95-2.36
	55+	396	454	1.830	1.482	0.0498	0.0356	1.730-1.930	1.411-1.553	1.03-2.77	0.84-2.17
Total Tapwater Intake	1-4	88	75	0.477	0.464	0.0403	0.0453	0.396-0.558	0.373-0.555	0.17-0.85	0.15-0.89
	5-11	249	201	0.550	0.533	0.0223	0.0239	0.505-0.595	0.485-0.581	0.22-0.90	0.22-0.93
	12-17	180	169	0.805	0.725	0.0372	0.0328	0.731-0.8790	0.659-0.791	0.29-1.35	0.31-1.16
	18-30	333	350	1.006	0.991	0.0363	0.0304	0.933-1.079	0.930-1.052	0.45-1.62	0.50-1.55
	31-54	512	551	1.201	1.091	0.0309	0.0240	1.139-1.263	1.043-1.139	0.64-1.88	0.62-1.68
	55+	396	454	1.133	1.027	0.0347	0.0273	1.064-1.202	0.972-1.082	0.62-1.72	0.54-1.57
Source: Hopkin and Ellis, 1980.											



Table 3-16. Measured Fluid Intakes (mL/day)

Subject	Total Fluids	Milk	Tapwater	Water-Based Drinks <sup>a</sup>
Adults ("normal" conditions) <sup>b</sup>	1000-2400	120-450	45-730	320-1450
Adults (high environmental temperature to 32°C)	2840-3410 3256 ± SD = 900			
Adults (moderately active)	3700			
Children (5-14 yr)	1000-1200 1310-1670	330-500 540-650	ca. 200	ca. 380 540-790

<sup>a</sup> Includes tea, coffee, soft drinks, beer, cider, wine, etc.  
<sup>b</sup> "Normal" conditions refer to typical environmental temperature and activity levels.  
 Source: ICRP, 1981.

*Gillies and Paulin (1983) - Variability of Mineral Intakes from Drinking Water* - Gillies and Paulin (1983) conducted a study to evaluate variability of mineral intake from drinking water. A study population of 109 adults (75 females; 34 males) ranging in age from 16 to 80 years (mean age = 44 years) in New Zealand was asked to collect duplicate samples of water consumed directly from the tap or used in beverage preparation during a 24-hour period. Participants were asked to collect the samples on a day when all of the water consumed would be from their own home. Individuals were selected based on their willingness to participate and their ability to comprehend the collection procedures. The mean total tapwater intake rate for this population was 1.25 (±0.39) L/day, and the 90th percentile rate was 1.90 L/day. The median total tapwater intake rate (1.26 L/day) was very similar to the mean intake rate (Gillies and Paulin, 1983). The reported range was 0.26 to 2.80 L/day.

The advantage of these data are that they were generated using duplicate sampling techniques. Because this approach is more objective than recall methods, it may result in more accurate response. However, these data are based on a short-term survey that may not be representative of long-term behavior, the population surveyed is small and the procedures for selecting the survey population were not designed to be representative of the New Zealand population, and the results may not be applicable to the United States. For these reasons the study is not regarded as a key study in this document.

*Pennington (1983) - Revision of the Total Diet Study Food List and Diets* - Based on data from the U.S. Food and Drug Administration's (FDA's) Total Diet Study, Pennington (1983) reported average intake rates for various foods and beverages for five age groups of the population. The Total Diet Study is conducted annually to monitor the nutrient and contaminant content of the U.S. food supply

and to evaluate trends in consumption. Representative diets were developed based on 24-hour recall and 2-day diary data from the 1977-1978 U.S. Department of Agriculture (USDA) Nationwide Food Consumption Survey (NFCS) and 24-hour recall data from the Second National Health and Nutrition Examination Survey (NHANES II). The number of participants in NFCS and NHANES II was approximately 30,000 and 20,000, respectively. The diets were developed to "approximate 90 percent or more of the weight of the foods usually consumed" (Pennington, 1983). The source of water (bottled water as distinguished from tapwater) was not stated in the Pennington study. For the purposes of this report, the consumption rates for the food categories defined by Pennington (1983) were used to calculate total fluid and total water intake rates for five age groups. Total water includes water, tea, coffee, soft drinks, and soups and frozen juices that are reconstituted with water. Reconstituted soups were assumed to be composed of 50 percent water, and juices were assumed to contain 75 percent water. Total fluids include total water in addition to milk, ready-to-use infant formula, milk-based soups, carbonated soft drinks, alcoholic beverages, and canned fruit juices. These intake rates are presented in Table 3-17. Based on the average intake rates for total water for the two adult age groups, 1.04 and 1.26 L/day, the average adult intake rate is about 1.15 L/day. These rates should be more representative of the amount of source-specific water consumed than are total fluid intake rates. Because this study was designed to measure food intake, and it used both USDA 1978 data and NHANES II data, there was not necessarily a systematic attempt to define tapwater intake per se, as distinguished from bottled



water. For this reason, it is not considered a key tapwater study in this document.

Table 3-17. Intake Rates of Total Fluids and Total Tapwater by Age Group

Average Daily Consumption Rate (L/day)		
Age Group	Total Fluids <sup>a</sup>	Total Tapwater <sup>b</sup>
6-11 months	0.80	0.20
2 years	0.99	0.50
14-16 years	1.47	0.72
25-30 years	1.76	1.04
60-65 years	1.63	1.26

<sup>a</sup> Includes milk, "ready-to-use" formula, milk-based soup, carbonated soda, alcoholic beverages, canned juices, water, coffee, tea, reconstituted juices, and reconstituted soups. Does not include reconstituted infant formula.

<sup>b</sup> Includes water, coffee, tea, reconstituted juices, and reconstituted soups.

Source: Derived from Pennington, 1983.

U.S. EPA (1984) - *An Estimation of the Daily Average Food Intake by Age and Sex for Use in Assessing the Radionuclide Intake of the General Population* - Using data collected by USDA in the 1977-78 NFCS, U.S. EPA (1984) determined daily food and beverage intake levels by age to be used in assessing radionuclide intake through food consumption. Tapwater, water-based drinks, and soups were identified subcategories of the total beverage category. Daily intake rates for tapwater, water-based drinks, soup, and total beverage are presented in Table 3-18. As seen in Table 3-18, mean tapwater

intake for different adult age groups (age 20 years and older) ranged from 0.62 to 0.76 L/day, water-based drinks intake ranged from 0.34 to 0.69 L/day, soup intake ranged from 0.03 to 0.06 L/day, and mean total beverage intake levels ranged from 1.48 to 1.73 L/day. Total tapwater intake rates were estimated by combining the average daily intakes of tapwater, water-based drinks, and soups for each age group. For adults (ages 20 years and older), mean total tapwater intake rates range from 1.04 to 1.47 L/day, and for children (ages <1 to 19 years), mean intake rates range from 0.19 to 0.90 L/day. These intake rates do not include reconstituted infant formula. The total tapwater intake rates, derived by combining data on tapwater, water-based drinks, and soup should be more representative of source-specific drinking water intake than the total beverage intake rates reported in this study. These intake rates are based on the same USDA NFCS data used in Ershow and Cantor (1989). Therefore, the data limitations discussed previously also apply to this study.

Cantor et al. (1987) - *Bladder Cancer, Drinkign Water Source, and Tapwater Consumption* - The National Cancer Institute (NCI), in a population-based, case control study investigating the possible relationship between bladder cancer and drinking water, interviewed approximately 8,000 adult white individuals, 21 to 84 years of age (2,805 cases and 5,258 controls) in their homes, using a standardized questionnaire (Cantor et al., 1987). The cases and controls resided in one of five metropolitan areas (Atlanta, Detroit, New Orleans, San

Table 3-18. Mean and Standard Error for the Daily Intake of Beverages and Tapwater by Age

Age (years)	Tapwater Intake (mL)	Water-Based Drinks (mL) <sup>a</sup>	Soups (mL)	Total Beverage Intake <sup>b</sup> (mL)
All ages	662.5 ± 9.9	457.1 ± 6.7	45.9 ± 1.2	1434.0 ± 13.7
Under 1	170.7 ± 64.5	8.3 ± 43.7	10.1 ± 7.9	307.0 ± 89.2
1 to 4	434.6 ± 31.4	97.9 ± 21.5	43.8 ± 3.9	743.0 ± 43.5
5 to 9	521.0 ± 26.4	116.5 ± 18.0	36.6 ± 3.2	861.0 ± 36.5
10 to 14	620.2 ± 24.7	140.0 ± 16.9	35.4 ± 3.0	1025.0 ± 34.2
15 to 19	664.7 ± 26.0	201.5 ± 17.7	34.8 ± 3.2	1241.0 ± 35.9
20 to 24	656.4 ± 33.9	343.1 ± 23.1	38.9 ± 4.2	1484.0 ± 46.9
25 to 29	619.8 ± 34.6	441.6 ± 23.6	41.3 ± 4.2	1531.0 ± 48.0
30 to 39	636.5 ± 27.2	601.0 ± 18.6	40.6 ± 3.3	1642.0 ± 37.7
40 to 59	735.3 ± 21.1	686.5 ± 14.4	51.6 ± 2.6	1732.0 ± 29.3
60 and over	762.5 ± 23.7	561.1 ± 16.2	59.4 ± 2.9	1547.0 ± 32.8

<sup>a</sup> Includes water-based drinks such as coffee, etc. Reconstituted infant formula does not appear to be included in this group.

<sup>b</sup> Includes tapwater and water-based drinks such as coffee, tea, soups, and other drinks such as soft drinks, fruitades, and alcoholic drinks.

Source: U.S. EPA, 1984.



Chapter 3 - Drinking Water Intake

Francisco, and Seattle) and five States (Connecticut, Iowa, New Jersey, New Mexico, and Utah). The individuals interviewed were asked to recall the level of intake of tapwater and other beverages in a typical week during the winter prior to the interview. Total beverage intake was divided into the following two components: 1) beverages derived from tapwater; and 2) beverages from other sources. Tapwater used in cooking foods and in ice cubes was apparently not considered. Participants also supplied information on the primary source of the water consumed (i.e., private well, community supply, bottled water, etc.). The control population was randomly selected from the general population and frequency matched to the bladder cancer case population in terms of age, sex, and geographic location of residence. The case population consisted of Whites only, had no people under the age of 21 years and 57 percent were over the age of 65 years. The fluid intake rates for the bladder cancer cases were not used because their participation in the study was based on selection factors that could bias the intake estimates for the general population. Based on responses from 5,258 White controls (3,892 males; 1,366 females), average tapwater intake rates for a "typical" week were compiled by sex, age group, and geographic region. These rates are listed in Table 3-19. The average total fluid intake rate was 2.01 L/day for men of which 70 percent (1.4 L/day) was derived from tapwater, and 1.72 L/day for women of which 79 percent (1.35 L/day) was derived from tapwater. Frequency distribution data for the 5,081 controls, for which the authors had information on both tapwater consumption and cigarette smoking habits, are presented in Table 3-20. These data follow a lognormal distribution having an average value of 1.30 L/day and an upper 90th percentile value of approximately 2.40 L/day. These values were determined by graphically interpolating the data of Table 3-20 after plotting it on log probability graph paper. These values represent the usual level of intake for this population of adults in the winter.

A limitation associated with this data set is that the population surveyed was older than the general population and consisted exclusively of Whites. Also, the intake data are based on recall of behavior from the winter previous to the interview. Extrapolation to other seasons and intake durations is difficult.

The authors presented data on person-years of residence with various types of water supply sources (municipal versus private, chlorinated versus nonchlorinated, and surface versus well water). Unfortunately, these data can not be used to draw conclusions about the National average apportionment of

surface versus groundwater since a large fraction (24 percent) of municipal water intake in this survey could not be specifically attributed to either ground or surface water.

Table 3-19. Average Total Tapwater Intake Rate by Sex, Age, and Geographic Area

Group/Subgroup	Number of Respondents	Average Total Tapwater Intake, <sup>a,b</sup> L/day
Total group	5,258	1.39
Sex		
Males	3,892	1.40
Females	1,366	1.35
Age, years		
21-44	291	1.30
45-64	1,991	1.48
65-84	2,976	1.33
Geographic area		
Atlanta	207	1.39
Connecticut	844	1.37
Detroit	429	1.33
Iowa	743	1.61
New Jersey	1,542	1.27
New Mexico	165	1.49
New Orleans	112	1.61
San Francisco	621	1.36
Seattle	316	1.44
Utah	279	1.35

<sup>a</sup> Standard deviations not reported in Cantor et al. (1987).  
<sup>b</sup> Total tapwater defined as all water and beverages derived from tapwater.  
 Source: Cantor et al., 1987.

Table 3-20. Frequency Distribution of Total Tapwater Intake Rates<sup>a</sup>

Consumption Rate (L/day)	Frequency <sup>b</sup> (%)	Cumulative Frequency <sup>b</sup> (%)
≤0.80	20.6	20.6
0.81-1.12	21.3	41.9
1.13-1.44	20.5	62.4
1.45-1.95	19.5	81.9
≥1.96	18.1	100.0

<sup>a</sup> Represents consumption of tapwater and beverages derived from tapwater in a "typical" winter week.  
<sup>b</sup> Extracted from Table 3 in Cantor et al. (1987).  
 Source: Cantor, et al., 1987.

AIHC (1994) - Exposure Factors Handbook - The Exposure Factors Sourcebook (AIHC, 1994) presented





drinking water intake rate recommendations for adults. Although AIHC (1994) provided little information on the studies used to derive mean and upper percentile recommendations, the references indicate that several of the studies used were the same as ones categorized as relevant studies in this handbook. The mean adult drinking water recommendations in AIHC (1994) and this handbook are in agreement. However, the upper percentile value recommended by AIHC (1994) (2.0 L/day) is slightly lower than that recommended by this handbook (2.4 L/day). Based on data provided by Ershow and Cantor (1989), 2.0 L/day corresponds to only approximately the 84th percentile of the drinking water intake rate distribution. Thus, a slightly higher value is appropriate for representing the upper percentile (i.e., 90 to 95th percentile) of the distribution. AIHC (1994) also presents simulated distributions of drinking water intake based on Roseberry and Burmaster (1992). These distributions are also described in detail in Section 3.2 of this handbook. AIHC (1994) has been classified as a relevant rather than a key study because it is not the primary source for the data used

to make recommendations for this document.

USDA (1995) - *Food and Nutrient Intakes by Individuals in the United States, 1 Day, 1989-91*. - USDA (1995) collected data on the quantity of "plain drinking water" and various other beverages consumed by individuals in 1 day during 1989 through 1991. The data were collected as part of USDA's Continuing Survey of Food Intakes by Individuals (CSFII). The data used to estimate mean per capita intake rates combined one-day dietary recall data from 3 survey years: 1989, 1990, and 1991 during which 15,128 individuals supplied one-day intake data. Individuals from all income levels in the 48 conterminous states and Washington D.C. were included in the sample. A complex three-stage sampling design was employed and the overall response rate for the study was 58 percent. To minimize the biasing effects of the low response rate and adjust for the seasonality, a series of weighting factors was incorporated into the data analysis. The intake rates based on this study are presented in Table 3-21. Table 3-21 includes data for: a) "plain drinking water", which might be assumed to mean tapwater directly

Table 3-21 Mean Per Capita Drinking Water Intake Based on USDA, CSFII Data From 1989-91 (mL/day)

Sex and Age (years)	Plain Drinking Water	Coffee	Tea	Fruit Drinks and Ades <sup>a</sup>	Total
Males and Females:					
Under 1	194	0	<0.5	17	211.5
1-2	333	<0.5	9	85	427.5
3-5	409	2	26	100	537
5 & Under	359	1	17	86	463
Males:					
6-11	537	2	44	114	697
12-19	725	12	95	104	936
20-29	842	168	136	101	1,247
30-39	793	407	136	50	1,386
40-49	745	534	149	53	1,481
50-59	755	551	168	51	1,525
60-69	946	506	115	34	1,601
70-79	824	430	115	45	1,414
80 and over	747	326	165	57	1,295
20 and over	809	408	139	60	1,416
Females:					
6-11	476	1	40	86	603
12-19	604	21	87	87	799
20-29	739	154	120	61	1,074
30-39	732	317	136	59	1,244
40-49	781	412	174	36	1,403
50-59	819	438	137	37	1,431
60-69	829	429	124	36	1,418
70-79	772	324	161	34	1,291
80 and over	856	275	149	28	1,308
20 and over	774	327	141	46	1,288
All individuals	711	260	114	65	1,150

<sup>a</sup> Includes regular and low calorie fruit drinks, punches, and ades, including those made from powdered mix and frozen concentrate. Excludes fruit juices and carbonated drinks.  
Source: USDA, 1995.



consumed rather than bottled water; b) coffee and tea, which might be assumed to be constituted from tapwater; and 3) fruit drinks and ades, which might be assumed to be reconstituted from tapwater rather than canned products; and 4) the total of the three sources. With these assumptions, the mean per capita total intake of water is estimated to be 1,416 mL/day for adult males (i.e., 20 years of age and older), 1,288 mL/day for adult females (i.e., 20 years of age and older) and 1,150 mL/day for all ages and both sexes combined. Although these assumptions appear reasonable, a close reading of the definitions used by USDA (1995) reveals that the word "tapwater" does not occur, and this uncertainty prevents the use of this study as a key study of tapwater intake.

The advantages of using these data are that; 1) the survey had a large sample size; 2) the authors attempted to represent the general United States population by oversampling low-income groups and by weighting the data to compensate for low response rates; and 3) it reflects more recent intake data than the key studies. The disadvantages are that: 1) the response rate was low; 2) the word "tapwater" was not defined and the assumptions that must be used in order to compare the data with the other tapwater studies might not be valid; 3) the data collection period reflects only a one-day intake period, and may not reflect long-term drinking water intake patterns; and 4) data on the percentiles of the distribution of intakes were not given.

*Tsang and Klepeis (1996) - National Human Activity Pattern Survey (NHAPS)* - The U.S. EPA collected information on the number of glasses of drinking water and juice reconstituted with tapwater consumed by the general population as part of the National Human Activity Pattern Survey (Tsang and Klepeis, 1996). NHAPS was conducted between October 1992 and September 1994. Over 9,000 individuals in the 48 contiguous United States provided data on the duration and frequency of selected activities and the time spent in selected microenvironments via 24-hour diaries. Over 4,000 NHAPS respondents also provided information of the number of 8-ounce glasses of water and the number of 8-ounce glasses of juice reconstituted with water than they drank during the 24-hour survey period (Tables 3-22 and 3-23). The median number of glasses of tapwater consumed was 1-2 and the median number of glasses of juice with tapwater consumed was 1-2.

For both individuals who drank tapwater and individuals who drank juices reconstituted with tapwater, the number of glasses ranged from 1 to 20. The highest percentage of the population (37.1 percent) who drank tapwater consumed 3-5 glasses and the highest percentage of the population (51.5 percent) who consumed juice reconstituted with tapwater drank 1-2 glasses. Based on the assumption that each glass contained 8 ounces of water (226.4 mL), the total volume of tapwater and juice with tapwater consumed would range from 0.23 L/day (1 glass) to 4.5 L/day (20 glasses) for respondents who drank tapwater. Using the same assumption, the volume of tapwater consumed for the population who consumed 3-5 glasses would be 0.68 L/day to 1.13 L/day and the volume of juice with tapwater consumed for the population who consumed 1-2 glasses would be 0.23 L/day to 0.46 L/day. Assuming that the average individual consumes 3-5 glasses of tapwater plus 1-2 glasses of juice with tapwater, the range of total tapwater intake for this individual would range from 0.9 L/day to 1.64 L/day. These values are consistent with the average intake rates observed in other studies.

The advantages of NHAPS is that the data were collected for a large number of individuals and that the data are representative of the U.S. population. However, evaluation of drinking water intake rates was not the primary purpose of the study and the data do not reflect the total volume of tapwater consumed. However, using the assumptions described above, the estimated drinking water intake rates from this study are within the same ranges observed for other drinking water studies.

### **3.4. PREGNANT AND LACTATING WOMEN**

*Ershow et al. (1991) - Intake of Tapwater and Total Water by Pregnant and Lactating Women* - Ershow et al. (1991) used data from the 1977-78 USDA NFCS to estimate total fluid and total tapwater intake among pregnant and lactating women (ages 15-49 years). Data for 188 pregnant women, 77 lactating women, and 6,201 non-pregnant, non-lactating control women were evaluated. The participants were interviewed based on 24 hour recall, and then asked to record a food diary for the next 2 days. "Tapwater" included tapwater consumed directly as a beverage and tapwater used to prepare food and tapwater-based beverages. "Total water" was defined as all water from tapwater and non-tapwater sources, including water contained in food. Estimated total fluid and total tapwater intake rates for the three groups are



Table 3-22. Number of Respondents that Consumed Tapwater at a Specified Daily Frequency

Population Group	Total N	Number of Glasses in a Day						
		None	1-2	3-5	6-9	10-19	20+	DK
<b>Overall</b>	4,663	1,334	1,225	1,253	500	151	31	138
<b>Gender</b>								
Male	2,163	604	582	569	216	87	25	65
Female	2,498	728	643	684	284	64	6	73
Refused	2	2	•	•	•	•	•	•
<b>Age (years)</b>								
1-4	263	114	96	40	7	1	0	5
5-11	348	90	127	86	15	7	2	20
12-17	326	86	109	88	22	7	•	11
18-64	2,972	908	751	769	334	115	26	54
> 64	670	117	127	243	112	20	2	42
<b>Race</b>								
White	3,774	1,048	1,024	1,026	416	123	25	92
Black	463	147	113	129	38	9	1	21
Asian	77	25	18	23	6	1	•	4
Some Others	96	36	18	22	6	7	2	5
Hispanic	193	63	42	40	28	10	2	7
Refused	60	15	10	13	6	1	1	9
<b>Hispanic</b>								
No	4,244	1,202	1,134	1,162	451	129	26	116
Yes	347	116	80	73	41	18	4	13
DK	26	5	6	7	4	3	•	1
Refused	46	11	5	11	4	1	1	8
<b>Employment</b>								
Full-time	2,017	637	525	497	218	72	18	40
Part-time	379	90	94	120	50	13	7	5
Not Employed	1,309	313	275	413	188	49	3	54
Refused	32	6	4	11	1	2	1	4
<b>Education</b>								
< High School	399	89	95	118	51	14	2	28
High School Graduate	1,253	364	315	330	132	52	13	37
< College	895	258	197	275	118	31	5	9
College Graduate	650	195	157	181	82	19	4	6
Post Graduate	445	127	109	113	62	16	3	12
<b>Census Region</b>								
Northeast	1,048	351	262	266	95	32	7	28
Midwest	1,036	243	285	308	127	26	9	33
South	1,601	450	437	408	165	62	11	57
West	978	290	241	271	113	31	4	20
<b>Day of Week</b>								
Weekday	3,156	864	840	862	334	96	27	106
Weekend	1,507	470	385	391	166	55	4	32
<b>Season</b>								
Winter	1,264	398	321	336	128	45	5	26
Spring	1,181	337	282	339	127	33	10	40
Summer	1,275	352	323	344	155	41	9	40
Fall	943	247	299	234	90	32	7	32
<b>Asthma</b>								
No	4,287	1,232	1,137	1,155	459	134	29	115
Yes	341	96	83	91	40	16	1	13
DK	35	6	5	7	1	1	1	10
<b>Angina</b>								
No	4,500	1,308	1,195	1,206	470	143	29	123
Yes	125	18	25	40	27	6	1	6
DK	38	8	5	7	3	2	1	9
<b>Bronchitis/Emphysema</b>								
No	4,424	1,280	1,161	1,189	474	142	29	124
Yes	203	48	55	58	24	9	1	5
DK	36	6	9	6	2	•	1	9

NOTE: "•" = Missing Data  
 "DK" = Don't know  
 N = sample size  
 Refused = respondent refused to answer  
 Source: Tsang and Kleipeis, 1996



Table 3-23. Number of Respondents that Consumed Juice Reconstituted with Tapwater at a Specified Daily Frequency

Population Group	Total N	Number of Glasses in a Day						
		None	1-2	3-5	6-9	10-19	20+	DK
<b>Overall</b>	4,663	1,877	1,418	933	241	73	21	66
<b>Gender</b>								
Male	2,163	897	590	451	124	35	17	33
Female	2,498	980	826	482	117	38	4	33
Refused	2	•	2	•	•	•	•	•
<b>Age (years)</b>								
1-4	263	126	71	48	11	4	1	2
5-11	348	123	140	58	12	2	1	11
12-17	326	112	118	63	18	7	1	4
18-64	2,972	1,277	817	614	155	46	16	30
> 64	670	206	252	133	43	12	2	14
<b>Race</b>								
White	3,774	1,479	1,168	774	216	57	16	44
Black	463	200	142	83	15	9	1	7
Asian	77	33	27	15	1	•	•	0
Some Others	96	46	19	24	2	1	3	1
Hispanic	193	95	51	30	5	5	1	5
Refused	60	24	11	7	2	1	•	9
<b>Hispanic</b>								
No	4,244	1,681	1,318	863	226	64	17	49
Yes	347	165	87	61	14	7	4	7
DK	26	11	6	5	•	1	•	3
Refused	46	20	7	4	1	1	•	7
<b>Employment</b>								
Full-time	2,017	871	559	412	103	32	9	20
Part-time	379	156	102	88	19	7	2	5
Not Employed	1,309	479	426	265	75	20	7	21
Refused	32	15	4	4	2	1	•	3
<b>Education</b>								
< High School	399	146	131	82	25	7	2	4
High School Graduate	1,253	520	355	254	68	21	7	17
< College	895	367	253	192	47	18	5	11
College Graduate	650	274	201	125	31	7	1	5
Post Graduate	445	182	130	92	26	5	3	4
<b>Census Region</b>								
Northeast	1,048	440	297	220	51	13	4	15
Midwest	1,036	396	337	200	63	17	4	14
South	1,601	593	516	332	84	26	10	28
West	978	448	268	181	43	17	3	9
<b>Day of Week</b>								
Weekday	3,156	1,261	969	616	162	51	11	46
Weekend	1,507	616	449	307	79	22	10	20
<b>Season</b>								
Winter	1,264	529	382	245	66	23	4	10
Spring	1,181	473	382	215	54	19	8	17
Summer	1,275	490	389	263	68	18	6	28
Fall	943	385	265	210	53	13	3	11
<b>Asthma</b>								
No	4,287	1,734	1,313	853	216	69	20	55
Yes	341	130	102	74	25	3	1	5
DK	35	13	3	6	•	1	•	6
<b>Angina</b>								
No	4,500	1,834	1,362	900	231	67	20	59
Yes	125	31	53	25	7	5	1	1
DK	38	12	3	8	3	1	•	6
<b>Bronchitis/Emphysema</b>								
No	4,424	1,782	1,361	882	230	65	21	57
Yes	203	84	53	44	10	6	•	3
DK	36	11	4	7	1	2	•	6

NOTE: "•" = Missing Data  
 "DK" = Don't know  
 N = sample size  
 Refused = Respondent refused to answer  
 Source: Tsang and Klepeis, 1996



presented in Tables 3-24 and 3-25, respectively. Lactating women had the highest mean total fluid intake rate (2.24 L/day) compared with both pregnant women (2.08 L/day) and control women (1.94 L/day). Lactating women also had a higher mean total tapwater intake rate (1.31 L/day) than pregnant women (1.19 L/day) and control women (1.16 L/day). The tapwater distributions are neither normal nor lognormal, but lactating women had a higher mean tapwater intake than controls and pregnant women. Ershow et al. (1991) also reported that rural women (n=1,885) consumed more total water (1.99 L/day) and tapwater (1.24 L/day) than urban/suburban women (n=4,581, 1.93 and 1.13 L/day, respectively). Total water and tapwater intake rates were lowest in the northeastern region of the United States (1.82 and 1.03 L/day) and highest in the western region of the United States (2.06 L/day and 1.21 L/day). Mean intake per unit body weight was highest among lactating women for both total fluid and total tapwater intake. Total tapwater intake accounted for over 50 percent of mean total fluid in all

these data sets (Section 3.2). A further advantage of this study is that it provides information on estimates of total water and tapwater intake rates for pregnant and lactating women. This topic has rarely been addressed in the literature.

3.5. HIGH ACTIVITY LEVELS/HOT CLIMATES

McNall and Schlegel (1968) - Practical Thermal Environmental Limits for Young Adult Males Working in Hot, Humid Environments - McNall and Schlegel (1968) conducted a study that evaluated the physiological tolerance of adult males working under varying degrees of physical activity. Subjects were required to pedal pedal-driven propeller fans for 8-hour work cycles under varying environmental conditions. The activity pattern for each individual was: cycled at 15 minute pedalling and 15 minute rest for each 8-hour period. Two groups of eight subjects each were used. Work rates were divided into three categories as follows: high activity level [0.15 horsepower (hp) per person], medium activity level (0.1

Table 3-24. Total Fluid Intake of Women 15-49 Years Old

Reproductive Status <sup>a</sup>	Mean	Standard Deviation	Percentile Distribution						
			5	10	25	50	75	90	95
<u>mL/day</u>									
Control	1940	686	995	1172	1467	1835	2305	2831	3186
Pregnant	2076	743	1085	1236	1553	1928	2444	3028	3475
Lactating	2242	658	1185	1434	1833	2164	2658	3169	3353
<u>mL/kg/day</u>									
Control	32.3	12.3	15.8	18.5	23.8	30.5	38.7	48.4	55.4
Pregnant	32.1	11.8	16.4	17.8	17.8	30.5	40.4	48.9	53.5
Lactating	37.0	11.6	19.6	21.8	21.8	35.1	45.0	53.7	59.2

<sup>a</sup> Number of observations: nonpregnant, nonlactating controls (n = 6,201); pregnant (n = 188); lactating (n = 77).  
Source: Ershow et al., 1991.

three groups of women (Table 3-25). Drinking water accounted for the largest single proportion of the total fluid intake for control (30 percent), pregnant (34 percent), and lactating women (30 percent) (Table 3-26). All other beverages combined accounted for approximately 46 percent, 43 percent, and 45 percent of the total water intake for control, pregnant, and lactating women, respectively. Food accounted for the remaining portion of total water intake.

The same advantages and limitations associated with the Ershow and Cantor (1989) data also apply to

hp per person), and low activity level (0.05 hp per person). Evidence of physical stress (i.e., increased body temperature, blood pressure, etc.) was recorded, and individuals were eliminated from further testing if certain stress criteria were met. The amount of water consumed by the test subjects during the work cycles was also recorded. Water was provided to the individuals on request. The water intake rates obtained at the three different activity levels and the various environmental temperatures are presented in Table 3-27. The data



Table 3-25. Total Tapwater Intake of Women 15-49 Years Old

Reproductive Status <sup>a</sup>	Mean	Standard Deviation	Percentile Distribution						
			5	10	25	50	75	90	95
<u>mL/day</u>									
Control	1157	635	310	453	709	1065	1503	1983	2310
Pregnant	1189	699	274	419	713	1063	1501	2191	2424
Lactating	1310	591	430	612	855	1330	1693	1945	2191
<u>mL/kg/day</u>									
Control	19.1	10.8	5.2	7.5	11.7	17.3	24.4	33.1	39.1
Pregnant	18.3	10.4	4.9	5.9	10.7	16.4	23.8	34.5	39.6
Lactating	21.4	9.8	7.4	9.8	14.8	20.5	26.8	35.1	37.4
<u>Fraction of daily fluid intake that is tapwater (%)</u>									
Control	57.2	18.0	24.6	32.2	45.9	59.0	70.7	79.0	83.2
Pregnant	54.1	18.2	21.2	27.9	42.9	54.8	67.6	76.6	83.2
Lactating	57.0	15.8	27.4	38.0	49.5	58.1	65.9	76.4	80.5

<sup>a</sup> Number of observations: nonpregnant, nonlactating controls (n = 6,201); pregnant (n = 188); lactating (n = 77).  
Source: Ershov et al., 1991.

Table 3-26. Total Fluid (mL/Day) Derived from Various Dietary Sources by Women Aged 15-49 Years<sup>a</sup>

Sources	Control Women			Pregnant Women			Lactating Women		
	Mean <sup>b</sup>	Percentile		Mean <sup>b</sup>	Percentile		Mean <sup>b</sup>	Percentile	
		50	95		50	95		50	95
Drinking Water	583	480	1440	695	640	1760	677	560	1600
Milk and Milk Drinks	162	107	523	308	273	749	306	285	820
Other Dairy Products	23	8	93	24	9	93	36	27	113
Meats, Poultry, Fish, Eggs	126	114	263	121	104	252	133	117	256
Legumes, Nuts, and Seeds	13	0	77	18	0	88	15	0	72
Grains and Grain Products	90	65	257	98	69	246	119	82	387
Citrus and Noncitrus Fruit Juices	57	0	234	69	0	280	64	0	219
Fruits, Potatoes, Vegetables, Tomatoes	198	171	459	212	185	486	245	197	582
Fats, Oils, Dressings, Sugars, Sweets	9	3	41	9	3	40	10	6	50
Tea	148	0	630	132	0	617	253	77	848
Coffee and Coffee Substitutes	291	159	1045	197	0	955	205	80	955
Carbonated Soft Drinks <sup>c</sup>	174	110	590	130	73	464	117	57	440
Noncarbonated Soft Drinks <sup>c</sup>	38	0	222	48	0	257	38	0	222
Beer	17	0	110	7	0	0	17	0	147
Wine Spirits, Liqueurs, Mixed Drinks	10	0	66	5	0	25	6	0	59
All Sources	1940	NA	NA	2076	NA	NA	2242	NA	NA

<sup>a</sup> Number of observations: nonpregnant, nonlactating controls (n = 6,201); pregnant (n = 188); lactating (n = 77).  
<sup>b</sup> Individual means may not add to all-sources total due to rounding.  
<sup>c</sup> Includes regular, low-calorie, and noncalorie soft drinks.  
NA: Not appropriate to sum the columns for the 50th and 95th percentiles of intake.  
Source: Ershov et al., 1991.



Table 3-27. Water Intake at Various Activity Levels (L/hr)<sup>a</sup>

Room Temperature <sup>b</sup> (°F)	Activity Level					
	High (0.15 hp/man) <sup>c</sup>		Medium (0.10 hp/man) <sup>c</sup>		Low (0.05 hp/man) <sup>c</sup>	
	No. <sup>d</sup>	Intake	No.	Intake	No.	Intake
100	--	--	--	--	15	0.653 (0.75)
95	18	0.540 (0.31)	12	0.345 (0.59)	6	0.50 (0.31)
90	7	0.286 (0.26)	7	0.385 (0.26)	16	0.23 (0.20)
85	7	0.218 (0.36)	16	0.213 (0.20)	--	--
80	16	0.222 (0.14)	--	--	--	--

<sup>a</sup> Data expressed as mean intake with standard deviation in parentheses.  
<sup>b</sup> Humidity = 80 percent; air velocity = 60 ft/min.  
<sup>c</sup> The symbol "hp" refers to horsepower.  
<sup>d</sup> Number of subjects with continuous data.  
Source: McNall and Schlegel, 1968.

presented are for test subjects with continuous data only (i.e., those test subjects who were not eliminated at any stage of the study as a result of stress conditions). Water intake was the highest at all activity levels when environmental temperatures were increased. The highest intake rate was observed at the low activity level at 100°F (0.65 L/hour) however, there were no data for higher activity levels at 100°F. It should be noted that this study estimated intake on an hourly basis during various levels of physical activity. These hourly intake rates cannot be converted to daily intake rates by multiplying by 24 hours/day because they are only representative of intake during the specified activity levels and the intake rates for the rest of the day are not known. Therefore, comparison of intake rate values from this study cannot be made with values from the previously described studies on drinking water intake.

*United States Army (1983) - Water Consumption Planning Factors Study* - The U.S. Army has developed water consumption planning factors to enable them to transport an adequate amount of water to soldiers in the field under various conditions (U.S. Army, 1983). Both

climate and activity levels were used to determine the appropriate water consumption needs. Consumption factors have been established for the following uses: 1) drinking, 2) heat treatment, 3) personal hygiene, 4) centralized hygiene, 5) food preparation, 6) laundry, 7) medical treatment, 8) vehicle and aircraft maintenance, 9) graves registration, and 10) construction. Only personal drinking water consumption factors are described here.

Drinking water consumption planning factors are based on the estimated amount of water needed to replace fluids lost by urination, perspiration, and respiration. It assumes that water lost to urinary output averages one quart/day (0.9 L/day) and perspiration losses range from almost nothing in a controlled environment to 1.5 quarts/day (1.4 L/day) in a very hot climate where individuals are performing strenuous work. Water losses to respiration are typically very low except in extreme cold where water losses can range from 1 to 3 quarts/day (0.9 to 2.8 L/day). This occurs when the humidity of inhaled air is near zero, but expired air is 98 percent saturated at body temperature (U.S. Army, 1983). Drinking water is defined by the U.S. Army (1983)



as "all fluids consumed by individuals to satisfy body needs for internal water." This includes soups, hot and cold drinks, and tapwater. Planning factors have been established for hot, temperate, and cold climates based on the following mixture of activities among the work force: 15 percent of the force performing light work, 65 percent of the force performing medium work, and 20 percent of the force performing heavy work. Hot climates are defined as tropical and arid areas where the temperature is greater than 80°F. Temperate climates are defined as areas where the mean daily temperature ranges from 32°F to 80°F. Cold regions are areas where the mean daily temperature is less than 32°F. Drinking water consumption factors for these three climates are presented in Table 3-28. These factors are based on research on individuals and small unit training exercises. The estimates are assumed to be conservative because they are rounded up to account for the subjective nature of the activity mix and minor water losses that are not considered (U.S. Army, 1983). The advantage of using these data is that they provide a conservative estimate of drinking water intake among individuals performing at various levels of physical activity in hot, temperate, and cold climates. However, the planning factors described here are based on assumptions about water loss from urination, perspiration, and respiration, and are not based on survey data or actual measurements.

**3.6. RECOMMENDATIONS**

The key studies described in this section were used in selecting recommended drinking water (tapwater) consumption rates for adults and children. The studies on other subpopulations were not classified as key versus

relevant. Although different survey designs and populations were utilized by key and relevant studies described in this report, the mean and upper-percentile estimates reported in these studies are reasonably similar. The general design of both key and relevant studies and their limitations are summarized in Table 3-29. It should be noted that studies that surveyed large representative samples of the population provide more reliable estimates of intake rates for the general population. Most of the surveys described here are based on short-term recall which may be biased toward excess intake rates. However, Cantor et al. (1987) noted that retrospective dietary assessments generally produce moderate correlations with "reference data from the past." A summary of the recommended values for drinking water intake rates is presented in Table 3-30.

*Adults* - The total tapwater consumption rates for adults (older than 18 or 20 years) that have been reported in the key surveys can be summarized in Table 3-31. For comparison, values for daily tapwater intake for the relevant studies are shown in Table 3-32.

Note that both Ershow and Cantor (1989) and Pennington (1983) found that adults above 60 years of age had larger intakes than younger adults. This is difficult to reconcile with the Cantor et al. (1987) study because the latter, older population had a smaller average intake. Because of these results, combined with the fact that the Cantor et al. (1987) study was not intended to be representative of the U. S. population, it is not included here in the determination of the recommended value. The

Table 3-28. Planning Factors for Individual Tapwater Consumption		
Environmental Condition	Recommended Planning Factor (gal/day) <sup>a</sup>	Recommended Planning Factor (L/day) <sup>a,b</sup>
Hot	3.0 <sup>c</sup>	11.4
Temperate	1.5 <sup>d</sup>	5.7
Cold	2.0 <sup>e</sup>	7.6

<sup>a</sup> Based on a mix of activities among the work force as follows: 15% light work; 65% medium work; 20% heavy work. These factors apply to the conventional battlefield where no nuclear, biological, or chemical weapons are used.

<sup>b</sup> Converted from gal/day to L/day.

<sup>c</sup> This assumes 1 quart/12-hour rest period/man for perspiration losses and 1 quart/day/man for urination plus 6 quarts/12-hours light work/man, 9 quarts/12-hours moderate work/man, and 12 quarts/12-hours heavy work/man.

<sup>d</sup> This assumes 1 quart/12-hour rest period/man for perspiration losses and 1 quart/day/man for urination plus 1 quart/12-hours light work/man, 3 quarts/12-hours moderate work/man, and 6 quarts/12-hours heavy work/man.

<sup>e</sup> This assumes 1 quart/12-hour rest period/man for perspiration losses, 1 quart/day/man for urination, and 2 quarts/day/man for respiration losses plus 1 quart/12-hours light work/man, 3 quarts/12-hours moderate work/man, and 6 quarts/6-hours heavy work/man.

Source: U.S. Army, 1983.





Table 3-29. Drinking Water Intake Surveys

Study	Number of Individuals	Type of Water Consumed	Time Period/ Survey Type	Population Surveyed	Comments
<u>KEY</u>					
Canadian Ministry of National Health and Welfare, 1981	970	Total tapwater consumption	Weekday and weekend day in both summer and winter; estimation based on sizes and types of containers used	All ages; Canada	Seasonal data; includes many tapwater-containing items not commonly surveyed; possible bias because identification of vessel size used as survey techniques; short-term study
Ershow and Cantor, 1989	Based on data from NFCS; approximately 30,000 individuals	Total tapwater; total fluid consumption	3-day recall, diaries	All ages; large sample representative of U.S. population	Short-term recall data; seasonally balanced data
Rosenberry and Burmaster, 1992	Based on data from Ershow and Cantor, 1989	Total tapwater; total fluid consumption	3-day recall, diaries	All ages; large sample representative of US population	Short-term recall data; seasonally balanced; suitable for Monte Carlo simulations
<u>RELEVANT</u>					
Cantor et al., 1987	5,258	Total tapwater; total fluid consumption	1 week/usual intake in winter based on recall	Adults only; weighted toward older adults; U.S. population	Based on recall of behavior from previous winter; short-term data; population not representative of general U.S. population
Gillies and Paulin, 1983	109	Total tapwater consumption	24 hours; duplicate water samples collected	Adults only; New Zealand	Based on short-term data
Hopkin and Ellis, 1980	3,564	Total tapwater, total liquid consumption	1 week period, diaries	All ages; Great Britain	Short-term diary data
ICRP, 1981	Based on data from several sources	Water and water-based drinks; milk; total fluids	NA <sup>a</sup>	NA <sup>a</sup>	Survey design and intake categories not clearly defined
NAS, 1977	Calculated average based on several sources	Average per capita "liquid" consumption	NA <sup>a</sup>	NA <sup>a</sup>	Total tapwater not reported; population and survey design not reported



Table 3-29. Drinking Water Intake Surveys (continued)

Study	Number of Individuals	Type of Water Consumed	Time Period/ Survey Type	Population Surveyed	Comments
Pennington, 1983	Based on NFCS and NHANES II; approximately 30,000 and 20,000 participants, respectively	Total tapwater; total fluid consumption	NFCS:24-hour recall on 2-day dairy; NHANES II:24-hour recall	NFCS:1 month to 97 years; NHANES II:6 months to 74 years; representative samples of U.S. population	Based on short-term recall data
USDA, 1995	Based on 89-91 CSF11; approximately 15,000 individuals	Plain drinking water, coffee, tea, fruit drinks and ades	1-day recall	All ages, large sample representative of U.S. population	Short-term recall data; seasonally adjusted
U.S. EPA, 1984	Based on NFCS; approximately 30,000 individuals	Tapwater; water based foods and beverages; soups; beverage consumption	3-day recall, diaries	All ages; large sample representative of U.S. population	Short-term recall data; seasonally balanced
U.S. EPA, 1995	Over 4,000 participants of NHAPS	Number of glasses of drinking water and juice with tapwater	24-hour diaries	All ages, large representative sample of U.S. population	Does not provide data on the volume of tapwater consumed
McNall and Schlegel, 1968	Based on 2 groups of 8 subjects each	Tapwater	8-hour work cycle	Males between 17-25 years of age; small sample; high activity levels/hot climates	Based on short-term data
U.S. Army, 1983	NA	All fluids consumed to satisfy body needs for internal water; includes soups, hot and cold drinks and tapwater	NA	High activity levels/hot climates	Study designed to provide water consumption planning factors for various activities and field conditions; based on estimated amount of water required to account for losses from urination, perspiration, and respiration

<sup>a</sup> Not applicable.



Table 3-30. Summary of Recommended Drinking Water Intake Rates

Age Group/ Population	Percentiles				Multiple	Fitted Distributions
	Mean	50th	90th	95th		
<1 year <sup>a</sup>	0.30 L/day 44 mL/kg-day	0.24 L/day 35 mL/kg-day	0.65 L/day 102 mL/kg-day	0.76 L/day 127 mL/kg-day	Tables 3-6, 3-7, and 3-8	Table 3-11 <sup>b</sup>
<3 years <sup>c</sup>	0.61 L/day	--	1.5 L/day	--	Table 3-3	
3-5 years <sup>c</sup>	0.87 L/day	--	1.5 L/day	--	Table 3-3	
1-10 years <sup>a</sup>	0.74 L/day 35 mL/kg-day	0.66 L/day 31 mL/kg-day	1.3 L/day 64 mL/kg-day	1.5 L/day 79.4 mL/kg-day	Tables 3-6, 3-7, and 3-8	Table 3-11 <sup>b</sup>
11-19 years <sup>a</sup>	0.97 L/day 18 mL/kg-day	0.87 L/day 16 mL/kg-day	1.7 L/day 32 mL/kg-day	2.0 L/day 40 mL/kg-day	Tables 3-6, 3-7, and 3-8	Table 3-11 <sup>b</sup>
Adults <sup>a</sup>	1.4 L/day 21 mL/kg-day	1.3 L/day 19 mL/kg-day	2.3 L/day 34 mL/kg-day		Tables 3-6, 3-7, and 3-8	Table 3-11 <sup>b</sup>
Pregnant Women <sup>d</sup>	1.2 L/day 18.3 mL/kg-day	1.1 L/day 16 mL/kg-day	2.2 L/day 35 mL/kg-day	2.4 L/day 40 mL/kg-day	Table 3-25	
Lactating Women <sup>d</sup>	1.3 L/day 21.4 mL/kg-day	1.3 L/day 21 mL/kg-day	1.9 L/day 35 mL/kg-day	2.2 L/day 37 mL/kg-day	Table 3-25	
Adults in High Activity/Hot Climate Conditions <sup>e</sup>	0.21 to 0.65 L/hour, depending on ambient temperature and activity level; see Table 3-27.					
Active Adults <sup>f</sup>	6 L/day (temperate climate) to 11 L/day (hot climate); see Table 3-28.					

a Source: Ershow and Cantor, 1989  
 b Source: Roseberry and Burmaster, 1992  
 c Source: Canadian Ministry of Health and Welfare, 1981  
 d Ershow et al. (1991) presented data for pregnant women, lactating women, and control women.  
 e Source: McNall and Schlegal, 1968  
 f Source: U.S. Army, 1983

Table 3-31. Total Tapwater Consumption Rates From Key Studies

Mean (L/day)	90th Percentile (L/day)	Number in Survey	Reference
1.38	2.41	639	Canadian Ministry of Health and Welfare, 1981
1.41	2.28	11,731	Ershow and Cantor, 1989

Table 3-32. Daily Tapwater Intake Rates From Relevant Studies

Mean (L/day)	90th Percentile	Reference
1.30 <sup>a</sup>	2.40	Cantor et al., 1987
1.63 (calculated)	--	NAS, 1977
1.25	1.90	Gillies and Paulin, 1983
1.04 (25 to 30 yrs)	--	Pennington, 1983
1.26 (60 to 65 yrs)	--	Pennington, 1983
1.04-1.47 (ages 20+)	--	U.S. EPA, 1984
1.37 (20 to 64 yrs)	2.27	Ershow and Cantor, 1989
1.46 (65+ yrs)	2.29	Ershow and Cantor, 1989
1.15	--	USDA, 1995
1.07	1.87	Hopkins and Ellis, 1980

<sup>a</sup> Age of the Cantor et al. (1987) population was higher than the U.S. average.

USDA (1995) data are not included because tapwater was not defined in the survey and because the response rate was low, although the results (showing lower intakes than the studies based on older data) may be accurately reflecting an expected lower use of tapwater (compared to 1978) because of increasing use of bottled water and soft drinks in recent years.

A value of 1.41 L/day, which is the population-weighted mean of the two national studies (Ershow and Cantor, 1989 and Canadian Ministry of Health and Welfare, 1981) is the recommended average tapwater intake rate.

The average of the 90th percentile values from the same two studies (2.35 L/day) is recommended as the appropriate upper limit. (The commonly-used 2.0 L/day intake rate corresponds to the 84th percentile of the intake rate distribution among the adults in the Ershow and Cantor (1989) study). In keeping with the desire to incorporate body weight into exposure assessments without introducing extraneous errors, the values from the



Chapter 3 - Drinking Water Intake

Ershow and Cantor (1989) study (Tables 3-7 and 3-8) expressed as mL/kg-day are recommended in preference to the liters/day units. For adults, the mean and 90th percentile values are 21 mL/kg-day and 34.2 mL/kg/day, respectively.

In the absence of actual data on chronic intake, the values in the previous paragraph are recommended as chronic values, although the chronic 90th upper percentile may very well be larger than 2.35 L/day. If a mathematical description of the intake distribution is needed, the parameters of lognormal fit to the Ershow and Cantor (1989) data (Tables 3-11 and 3-12) generated by Roseberry and Burmaster (1992) may be used. The simulated balanced population distribution of intakes generated by Roseberry and Burmaster is not recommended for use in the post-1997 time frame, since it corrects the 1978 data only for the differences in the age structure of the U. S. population between 1978 and 1988.

These recommended values are different than the 2 liters/day commonly assumed in EPA risk assessments. Assessors are encouraged to use values which most accurately reflect the exposed population. When using values other than 2 liters/day, however, the assessors should consider if the dose estimate will be used to estimate risk by combining with a dose-response relationship which was derived assuming a tap water intake of 2 liters/day. If such an inconsistency exists, the assessor should adjust the dose-response relationship as described in Appendix 1 of Chapter 1. IRIS does not use a tap water intake assumption in the derivation of RfCs and RfDs, but does make the 2 liter/day assumption in the derivation of cancer slope factors and unit risks.

*Children* - The tapwater intake rates for children reported in the key studies are summarized in Table 3-33.

The intake rates, as expressed as liters per day, generally increase with age, and the data are consistent across ages for the two key studies except for the Canadian Ministry of Health and Welfare (1981) data for ages 6 to 17 years; it is recommended that any of the liters/day values that match the age range of interest except the Canada data for ages 6 to 17 years be used. The mL/kg-day intake values show a consistent downward trend with increasing ages; using the Ershow and Cantor (1989) data in preference to the Canadian Ministry of National Health and Welfare (1981) data is recommended where the age ranges overlap.

The intakes for children as reported in the relevant studies are shown in Table 3-34.

Age (years)	Mean (L/day)	90th Percentile (L/day)	Reference
<1	0.30	0.65	Ershow and Cantor, 1989
<3	0.61	1.50	Canadian Ministry of National Health and Welfare, 1981
3-5	0.87	1.50	Canadian Ministry of National Health and Welfare, 1981
1-10	0.74	1.29	Ershow and Cantor, 1989
6-17	1.14	2.21	Canadian Ministry of National Health and Welfare, 1981
11-19	0.97	1.70	Ershow and Cantor, 1989

Age	Mean (L/day)	Reference
6-11 months	0.20	Pennington, 1983
<1 yr	0.19	U.S. EPA, 1984
<1 yr	0.32	Roseberry and Burmaster, 1992
2 yrs	0.50	Pennington, 1983
1-4 yrs	0.58	U.S. EPA, 1984
5-9 yrs	0.67	U.S. EPA, 1984
1-10 yrs	0.70	Roseberry and Burmaster, 1992
10-14 yrs	0.80	U.S. EPA, 1984
14-16 yrs	0.72	Pennington, 1983
15-19 yrs	0.90	U.S. EPA, 1984
11-19 yrs	0.91	Roseberry and Burmaster, 1992

Disregarding the Roseberry and Burmaster study, which is a recalculation of the Ershow and Cantor (1989) study, the non-key studies generally have lower mean intake values than the Ershow and Cantor (1899) study. The reason is not known, but the results are not persuasive enough to discount the recommendations based on the latter study. Intake rates for specific percentiles of the distribution may be selected using the lognormal distribution data generated by Roseberry and Burmaster (1992) (Tables 3-11 and 3-12).

*Pregnant and Lactating Women* -The data on tapwater intakes for control, pregnant, and lactating



women are presented in Table 3-25. The recommended intake values are presented in Table 3-30.

*High Activity/Hot Climates* - Data on intake rates for individuals performing strenuous activities under various environmental conditions are limited. None of these is classed as a key study because the populations in these studies are not representative of the general U.S. population. However, the data presented by McNall and Schlegel (1968) and U.S. Army (1983) provide bounding intake values for these individuals. According to McNall and Schlegel (1968), hourly intake can range from 0.21 to 0.65 L/hour depending on the temperature and activity level. Intake among physically active individuals can range from 6 L/day in temperate climates to 11 L/day in hot climates (U.S. Army, 1983).

A characterization of the overall confidence in the accuracy and appropriateness of the recommendations for drinking water is presented in Table 3-35. Although the study of Ershow and Cantor (1989) is of high quality and consistent with the other surveys, the low currency of the information (1978 data collection), in the presence of anecdotal information (not presented here) that the consumption of bottled water and beverages has increased since 1980 was the main reason for lowering the confidence score of the overall recommendations from high to medium.



Table 3-35. Confidence in Tapwater Intake Recommendations

Considerations	Rationale	Rating
<b>Study Elements</b>		
• Level of peer review	The study of Ershow and Cantor (1989) had a thorough expert panel review. Review procedures were not reported in the Canadian study; it was a government report. Other reports presented are published in scientific journals.	High
• Accessibility	The two monographs are available from the sponsoring agencies; the others are library-accessible.	High
• Reproducibility	Methods are well-described.	High
• Focus on factor of interest	The studies are directly relevant to tapwater.	High
• Data pertinent to U.S.	See "representativeness" below.	NA
• Primary data	The two monographs used recent primary data (less than one week) on recall of intake.	High
• Currency	Data were all collected in the 1978 era. Tapwater use may have changed since that time period.	Low
• Adequacy of data collection period	These are one- to three-day intake data. However, long term variability may be small. Their use as a chronic intake measure can be assumed.	Medium
• Validity of approach	The approach was competently executed.	High
• Study size	This study was the largest monograph that had data for 11,000 individuals.	High
• Representativeness of the population	The Ershow and Cantor (1989) and Canadian surveys were validated as demographically representative.	High
• Characterization of variability	The full distributions were given in the main studies.	High
• Lack of bias in study design (high rating is desirable)	Bias was not apparent.	High
• Measurement error	No physical measurements were taken. The method relied on recent recall of standardized volumes of drinking water containers, and was not validated.	Medium
<b>Other Elements</b>		
• Number of studies	There were two key studies for the adult and child recommendations. There were six other studies for adults, one study for pregnant and lactating women, and two studies for high activity/hot climates.	High for adult and children. Low for the other recommended subpopulation values.
• Agreement between researchers	This agreement was good.	High
<b>Overall Rating</b>	The data are excellent, but are not current.	Medium



3.7. REFERENCES FOR CHAPTER 3

American Industrial Health Council (AIHC). (1994) Exposure factors sourcebook. AIHC, Washington, DC.

Bourne, G.H.; Kidder, G.W., eds. (1953) Biochemistry and physiology of nutrition. Vol. 1. New York, NY: Academic Press.

Canadian Ministry of National Health and Welfare (1981) Tapwater consumption in Canada. Document number 82-EHD-80. Public Affairs Directorate, Department of National Health and Welfare, Ottawa, Canada.

Cantor, K.P.; Hoover, R.; Hartge, P.; Mason, T.J.; Silverman, D.T.; et al. (1987) Bladder cancer, drinking water source, and tapwater consumption: A case-control study. *J. Natl. Cancer Inst.* 79(6):1269-1279.

Ershow, A.G.; Brown, L.M.; Cantor, K.P. (1991) Intake of tapwater and total water by pregnant and lactating women. *American Journal of Public Health.* 81:328-334.

Ershow, A.G.; Cantor, K.P. (1989) Total water and tapwater intake in the United States: population-based estimates of quantities and sources. Life Sciences Research Office, Federation of American Societies for Experimental Biology.

Evans, C.L., ed. (1941) Starling's principles of human physiology, 8th ed. Philadelphia, PA: Lea and Febiger.

Gillies, M.E.; Paulin, H.V. (1983) Variability of mineral intakes from drinking water: A possible explanation for the controversy over the relationship of water quality to cardiovascular disease. *Int. J. Epid.* 12(1):45-50.

Guyton, A.C. (1968) Textbook of medical physiology, 3rd ed. Philadelphia, PA: W.B. Saunders Co.

Hopkins, S.M.; Ellis, J.C. (1980) Drinking water consumption in Great Britain: a survey of drinking habits with special reference to tap-water-based beverages. Technical Report 137, Water Research Centre, Wiltshire Great Britain.

ICRP. (1981) International Commission on Radiological Protection. Report of the task group on reference man. New York: Pergamon Press.

McNall, P.E.; Schlegel, J.C. (1968) Practical thermal environmental limits for young adult males working in hot, humid environments. American Society of Heating, Refrigerating and Air-Conditioning Engineers (ASHRAE) Transactions 74:225-235.

National Academy of Sciences (NAS). (1974) Recommended dietary allowances, 8th ed. Washington, DC: National Academy of Sciences-National Research Council.

National Academy of Sciences (NAS). (1977) Drinking water and health. Vol. 1. Washington, DC: National Academy of Sciences-National Research Council.

Pennington, J.A.T. (1983) Revision of the total diet study food list and diets. *J. Am. Diet. Assoc.* 82:166-173.

Pike, R.L.; Brown, M. (1975) Minerals and water in nutrition--an integrated approach, 2nd ed. New York, NY: John Wiley.

Randall, H.T. (1973) Water, electrolytes and acid base balance. In: Goodhart RS, Shils ME, eds. Modern nutrition in health and disease. Philadelphia, PA: Lea and Febiger.

Roseberry, A.M.; Burmaster, D.E. (1992) Lognormal distribution for water intake by children and adults. *Risk Analysis* 12:99-104.

Tsang, A.M.; Klepeis, N.E. (1996) Results tables from a detailed analysis of the National Human Activity Pattern Survey (NHAPS) responses. Draft Report prepared for the U.S. Environmental Protection Agency by Lockheed Martin, Contract No. 68-W6-001, Delivery Order No. 13.

U.S. Army. (1983) Water Consumption Planning Factors Study. Directorate of Combat Developments, United States Army Quartermaster School, Fort Lee, Virginia.

USDA. (1995) Food and nutrient intakes by individuals in the United States, 1 day, 1989-91. United States Department of Agriculture, Agricultural Research Service. NFS Report No. 91-2.

U.S. EPA. (1980) U.S. Environmental Protection Agency. Water quality criteria documents; availability. Federal Register, (November 28) 45(231):79318-79379.

U.S. EPA. (1984) An estimation of the daily average food intake by age and sex for use in assessing the radionuclide intake of individuals in the general population. EPA-520/1-84-021.

U.S. EPA. (1991) U.S. Environmental Protection Agency. National Primary Drinking Water Regulation; Final Rule. Federal Register 56(20):3526-3597. January 30, 1991.

Walker, B.S.; Boyd, W.C.; Asimov, I. (1957) Biochemistry and human metabolism, 2nd ed. Baltimore, MD: Williams & Wilkins Co.

Wolf, A.V. (1958) Body water. *Sci. Am.* 99:125.

## TABLE OF CONTENTS

	<u>Page No.</u>
4. SOIL INGESTION AND PICA .....	1
4.1 BACKGROUND .....	1
4.2. KEY STUDIES ON SOIL INTAKE AMONG CHILDREN .....	1
4.3. RELEVANT STUDIES ON SOIL INTAKE AMONG CHILDREN .....	11
4.4. SOIL INTAKE AMONG ADULTS .....	16
4.5. PREVALENCE OF PICA .....	17
4.6. DELIBERATE SOIL INGESTION AMONG CHILDREN .....	18
4.7. RECOMMENDATIONS .....	20
4.8. REFERENCES FOR CHAPTER 4 .....	25





**4. SOIL INGESTION AND PICA**

**4.1. BACKGROUND**

The ingestion of soil is a potential source of human exposure to toxicants. The potential for exposure to contaminants via this source is greater for children because they are more likely to ingest more soil than adults as a result of behavioral patterns present during childhood. Inadvertent soil ingestion among children may occur through the mouthing of objects or hands. Mouthing behavior is considered to be a normal phase of childhood development. Adults may also ingest soil or dust particles that adhere to food, cigarettes, or their hands. Deliberate soil ingestion is defined as pica and is considered to be relatively uncommon. Because normal, inadvertent soil ingestion is more prevalent and data for individuals with pica behavior are limited, this section focuses primarily on normal soil ingestion that occurs as a result of mouthing or unintentional hand-to-mouth activity.

Several studies have been conducted to estimate the amount of soil ingested by children. Most of the early studies attempted to estimate the amount of soil ingested by measuring the amount of dirt present on children's hands and making generalizations based on behavior. More recently, soil intake studies have been conducted using a methodology that measures trace elements in feces and soil that are believed to be poorly absorbed in the gut. These measurements are used to estimate the amount of soil ingested over a specified time period. The available studies on soil intake are summarized in the following sections. Studies on soil intake among children have been classified as either key studies or relevant studies based on their applicability to exposure assessment needs. Recommended intake rates are based on the results of key studies, but relevant studies are also presented to provide the reader with added perspective on the current state-of-knowledge pertaining to soil intake. Information on soil ingestion among adults is presented based on available data from a limited number of studies. This is an area where more data and more research are needed. Relevant information on the prevalence of pica and intake among individuals exhibiting pica behavior is also presented.

**4.2. KEY STUDIES ON SOIL INTAKE AMONG CHILDREN**

*Binder et al. (1986) - Estimating Soil Ingestion: Use of Tracer Elements in Estimating the Amount of Soil Ingested by Young Children* - Binder et al. (1986) studied the ingestion of soil among children 1 to 3 years of age who wore diapers using a tracer technique modified from a

method previously used to measure soil ingestion among grazing animals. The children were studied during the summer of 1984 as part of a larger study of residents living near a lead smelter in East Helena, Montana. Soiled diapers were collected over a 3-day period from 65 children (42 males and 23 females), and composited samples of soil were obtained from the children's yards. Both excreta and soil samples were analyzed for aluminum, silicon, and titanium. These elements were found in soil, but were thought to be poorly absorbed in the gut and to have been present in the diet only in limited quantities. This made them useful tracers for estimating soil intake. Excreta measurements were obtained for 59 of the children. Soil ingestion by each child was estimated based on each of the three tracer elements using a standard assumed fecal dry weight of 15 g/day, and the following equation:

$$T_{i,e} = \frac{f_{i,e} \times F_i}{S_{i,e}} \quad \text{(Eqn. 4-1)}$$

where:

- $T_{i,e}$  = estimated soil ingestion for child i based on element e (g/day);
- $f_{i,e}$  = concentration of element e in fecal sample of child i (mg/g);
- $F_i$  = fecal dry weight (g/day); and
- $S_{i,e}$  = concentration of element e in child i's yard soil (mg/g).

The analysis conducted by Binder et al. (1986) assumed that: (1) the tracer elements were neither lost nor introduced during sample processing; (2) the soil ingested by children originates primarily from their own yards; and (3) that absorption of the tracer elements by children occurred in only small amounts. The study did not distinguish between ingestion of soil and housedust nor did it account for the presence of the tracer elements in ingested foods or medicines.

The arithmetic mean quantity of soil ingested by the children in the Binder et al. (1986) study was estimated to be 181 mg/day (range 25 to 1,324) based on the aluminum tracer; 184 mg/day (range 31 to 799) based on the silicon tracer; and 1,834 mg/day (range 4 to 17,076) based on the titanium tracer (Table 4-1). The



Table 4-1. Estimated Daily Soil Ingestion Based on Aluminum, Silicon, and Titanium Concentrations

Estimation Method	Mean (mg/day)	Median (mg/day)	Standard Deviation (mg/day)	Range (mg/day)	95th Percentile (mg/day)	Geometric Mean (mg/day)
Aluminum	181	121	203	25-1,324	584	128
Silicon	184	136	175	31-799	5,78	130
Titanium	1,834	618	3,091	4-17,076	9,590	401
Minimum	108	88	121	4-708	386	65

Source: Binder et al., 1986.

overall mean soil ingestion estimate based on the minimum of the three individual tracer estimates for each child was 108 mg/day (range 4 to 708). The 95th percentile values for aluminum, silicon, and titanium were 584 mg/day, 578 mg/day, and 9,590 mg/day, respectively. The 95th percentile value based on the minimum of the three individual tracer estimates for each child was 386 mg/day.

The authors were not able to explain the difference between the results for titanium and for the other two elements, but speculated that unrecognized sources of titanium in the diet or in the laboratory processing of stool samples may have accounted for the increased levels. The frequency distribution graph of soil ingestion estimates based on titanium shows that a group of 21 children had particularly high titanium values (i.e., >1,000 mg/day). The remainder of the children showed titanium ingestion estimates at lower levels, with a distribution more comparable to that of the other elements.

The advantages of this study are that a relatively large number of children were studied and tracer elements were used to estimate soil ingestion. However, the children studied may not be representative of the U.S. population and the study did not account for tracers ingested via foods or medicines. Also, the use of an assumed fecal weight instead of actual fecal weights may have biased the results of this study. Finally, because of the short-term nature of the survey, soil intake estimates may not be entirely representative of long-term behavior, especially at the upper-end of the distribution of intake.

*Clausing et al. (1987) - A Method for Estimating Soil Ingestion by Children* - Clausing et al. (1987) conducted a soil ingestion study with Dutch children using a tracer element methodology similar to that of Binder et al. (1986). Aluminum, titanium, and acid-insoluble residue (AIR) contents were determined for fecal samples from

children, aged 2 to 4 years, attending a nursery school, and for samples of playground dirt at that school. Twenty-seven daily fecal samples were obtained over a 5-day period for the 18 children examined. Using the average soil concentrations present at the school, and assuming a standard fecal dry weight of 10 g/day, Clausing et al. (1987) estimated soil ingestion for each tracer. Clausing et al. (1987) also collected eight daily fecal samples from six hospitalized, bedridden children. These children served as a control group, representing children who had very limited access to soil.

The average quantity of soil ingested by the school children in this study was as follows: 230 mg/day (range 23 to 979 mg/day) for aluminum; 129 mg/day (range 48 to 362 mg/day) for AIR; and 1,430 mg/day (range 64 to 11,620 mg/day) for titanium (Table 4-2). As in the Binder et al. (1986) study, a fraction of the children (6/19) showed titanium values well above 1,000 mg/day, with most of the remaining children showing substantially lower values. Based on the Limiting Tracer Method (LTM), mean soil intake was estimated to be 105 mg/day with a population standard deviation of 67 mg/day (range 23 to 362 mg/day). Use of the LTM assumed that "the maximum amount of soil ingested corresponded with the lowest estimate from the three tracers" (Clausing et al., 1987). Geometric mean soil intake was estimated to be 90 mg/day. This assumes that the maximum amount of soil ingested cannot be higher than the lowest estimate for the individual tracers.

Mean soil intake for the hospitalized children was estimated to be 56 mg/day based on aluminum (Table 4-3). For titanium, three of the children had estimates well in excess of 1,000 mg/day, with the remaining three children in the range of 28 to 58 mg/day. Using the LTM



Table 4-2. Calculated Soil Ingestion by Nursery School Children

Child	Sample Number	Soil Ingestion as Calculated from Ti (mg/day)	Soil Ingestion as Calculated from Al (mg/day)	Soil Ingestion as Calculated from AIR (mg/day)	Limiting Tracer (mg/day)
1	L3	103	300	107	103
	L14	154	211	172	154
	L25	130	23	-	23
2	L5	131	-	71	71
	L13	184	103	82	82
	L27	142	81	84	81
3	L2	124	42	84	42
	L17	670	566	174	174
4	L4	246	62	145	62
	L11	2,990	65	139	65
5	L8	293	-	108	108
	L21	313	-	152	152
6	L12	1,110	693	362	362
	L16	176	-	145	145
7	L18	11,620	-	120	120
	L22	11,320	77	-	77
8	L1	3,060	82	96	82
	L6	624	979	111	111
10	L7	600	200	124	124
	L9	133	-	95	95
12	L10	354	195	106	106
	L15	2,400	-	48	48
14	L19	124	71	93	71
	L20	269	212	274	212
16	L23	1,130	51	84	51
	L24	64	566	-	64
18	L26	184	56	-	56
	Arithmetic Mean	1,431	232	129	105

Source: Adapted from Clausing et al. 1987.

Table 4-3. Calculated Soil Ingestion by Hospitalized, Bedridden Children

Child	Sample	Soil Ingestion as Calculated from Ti (mg/day)	Soil Ingestion as Calculated from Al (mg/day)	Limiting Tracer (mg/day)
1	G5	3,290	57	57
	G6	4,790	71	71
2	G1	28	26	26
	G2	6,570	94	84
3	G8	2,480	57	57
	G3	28	77	28
4	G4	1,100	30	30
	G7	58	38	38
Arithmetic Mean		2,293	56	49

Source: Adapted from Clausing et al. 1987.

method, the mean soil ingestion rate was estimated to be 49 mg/day with a population standard deviation of 22 mg/day (range 26 to 84 mg/day). The geometric mean soil intake rate was 45 mg/day. The data on hospitalized children

suggest a major nonsoil source of titanium for some children, and may suggest a background nonsoil source of aluminum. However, conditions specific to hospitalization (e.g., medications) were not considered. AIR



measurements were not reported for the hospitalized children. Assuming that the tracer-based soil ingestion rates observed in hospitalized children actually represent background tracer intake from dietary and other nonsoil sources, mean soil ingestion by nursery school children was estimated to be 56 mg/day, based on the LTM (i.e., 105 mg/day for nursery school children minus 49 mg/day for hospitalized children) (Clausing et al. 1987).

The advantages of this study are that Clausing et al. (1987) evaluated soil ingestion among two populations of children that had differences in access to soil, and corrected soil intake rates based on background estimates derived from the hospitalized group. However, a smaller number of children were used in this study than in the Binder et al. (1986) study and these children may not be representative of the U.S. population. Tracer elements in foods or medicines were not evaluated. Also, intake rates derived from this study may not be representative of soil intake over the long-term because of the short-term nature of the study. In addition, one of the factors that could affect soil intake rates is hygiene (e.g., hand washing frequency). Hygienic practices can vary across countries and cultures and may be more stringently emphasized in a more structured environment such as child care centers in The Netherlands and other European countries than in child care centers in the United States.

*Calabrese et al. (1989) - How Much Soil do Young Children Ingest: An Epidemiologic Study* - Calabrese et al. (1989) studied soil ingestion among children using the basic tracer design developed by Binder et al. (1986). However, in contrast to the Binder et al. (1986) study, eight tracer elements (i.e., aluminum, barium, manganese, silicon, titanium, vanadium, yttrium, and zirconium) were analyzed instead of only three (i.e., aluminum, silicon, and titanium). A total of 64 children between the ages of 1 and 4 years old were included in the study. These children were all selected from the greater Amherst, Massachusetts area and were predominantly from two-parent households where the parents were highly educated. The Calabrese et al. (1989) study was conducted over eight days during a two week period and included the use of a mass-balance methodology in which duplicate samples of food, medicines, vitamins, and others were collected and analyzed on a daily basis, in addition to soil and dust samples collected from the child's home and play area. Fecal and urine samples were also collected and analyzed for tracer elements. Toothpaste, low in tracer content, was provided to all participants.

In order to validate the mass-balance methodology used to estimate soil ingestion rates among children and to

determine which tracer elements provided the most reliable data on soil ingestion, known amounts of soil (i.e., 300 mg over three days and 1,500 mg over three days) containing eight tracers were administered to six adult volunteers (i.e., three males and three females). Soil samples and feces samples from these adults and duplicate food samples were analyzed for tracer elements to calculate recovery rates of tracer elements in soil. Based on the adult validation study, Calabrese et al. (1989) confirmed that the tracer methodology could adequately detect tracer elements in feces at levels expected to correspond with soil intake rates in children. Calabrese et al. (1989) also found that aluminum, silicon, and yttrium were the most reliable of the eight tracer elements analyzed. The standard deviation of recovery of these three tracers was the lowest and the percentage of recovery was closest to 100 percent (Calabrese, et al., 1989). The recovery of these three tracers ranged from 120 to 153 percent when 300 mg of soil had been ingested over a three-day period and from 88 to 94 percent when 1,500 mg soil had been ingested over a three-day period (Table 4-4).

Using the three most reliable tracer elements, the mean soil intake rate for children, adjusted to account for the amount of tracer found in food and medicines, was estimated to be 153 mg/day based on aluminum, 154 mg/day based on silicon, and 85 mg/day based on yttrium (Table 4-5). Median intake rates were somewhat lower (29 mg/day for aluminum, 40 mg/day for silicon, and 9 mg/day for yttrium). Upper-percentile (i.e., 95th) values were 223 mg/day for aluminum, 276 mg/day for silicon, and 106 mg/day for yttrium. Similar results were observed when soil and dust ingestion was combined (Table 4-5). Intake of soil and dust was estimated using a weighted average of tracer concentration in dust composite samples and in soil composite samples based on the time children spent at home and away from home, and indoors and outdoors. Calabrese et al. (1989) suggested that the use of titanium as a tracer in earlier studies that lacked food ingestion data may have significantly overestimated soil intake because of the high levels of titanium in food. Using the median values of aluminum and silicon, Calabrese et al. (1989) estimated the quantity of soil ingested daily to be 29 mg/day and 40 mg/day, respectively. It should be noted that soil



Tracer Element	300 mg Soil Ingested		1500 mg Soil Ingested	
	Mean	SD	Mean	SD
Al	152.8	107.5	93.5	15.5
Ba	2304.3	4533.0	149.8	69.5
Mn	1177.2	1341.0	248.3	183.6
Si	139.3	149.6	91.8	16.6
Ti	251.5	316.0	286.3	380.0
V	345.0	247.0	147.6	66.8
Y	120.5	42.4	87.5	12.6
Zr	80.6	43.7	54.6	33.4

Source: Adapted from Calabrese et al., 1989.

Tracer Element	N	Intake (mg/day) <sup>a</sup>				
		Mean	Median	SD	95th Percentile	Maximum
Aluminum						
soil	64	153	29	852	223	6,837
dust	64	317	31	1,272	506	8,462
soil/dust combined	64	154	30	629	478	4,929
Silicon						
soil	64	154	40	693	276	5,549
dust	64	964	49	6,848	692	54,870
soil/dust combined	64	483	49	3,105	653	24,900
Yttrium						
soil	62	85	9	890	106	6,736
dust	64	62	15	687	169	5,096
soil/dust combined	62	65	11	717	159	5,269
Titanium						
soil	64	218	55	1,150	1,432	6,707
dust	64	163	28	659	1,266	3,354
soil/dust combined	64	170	30	691	1,059	3,597

<sup>a</sup> Corrected for Tracer Concentrations in Foods  
 Source: Adapted from Calabrese et al., 1989.

ingestion for one child in the study ranged from approximately 10 to 14 grams/day during the second week of observation. Average soil ingestion for this child was 5 to 7 mg/day, based on the entire study period.

The advantages of this study are that intake rates were corrected for tracer concentrations in foods and medicines and that the methodology was validated using adults. Also, intake was observed over a longer time period in this study than in earlier studies and the number of tracers

used was larger than for other studies. A relatively large population was studied, but they may not be entirely representative of the U.S. population because they were selected from a single location.

*Davis et al. (1990) - Quantitative Estimates of Soil Ingestion in Normal Children Between the ages of 2 and 7 years: Population-Based Estimates Using Aluminum, Silicon, and Titanium as Soil Tracer Elements - Davis et*



al. (1990) also used a mass-balance/tracer technique to estimate soil ingestion among children. In this study, 104 children between the ages of 2 and 7 years were randomly selected from a three-city area in southeastern Washington State. The study was conducted over a seven day period, primarily during the summer. Daily soil ingestion was evaluated by collecting and analyzing soil and house dust samples, feces, urine, and duplicate food samples for aluminum, silicon, and titanium. In addition, information on dietary habits and demographics was collected in an attempt to identify behavioral and demographic characteristics that influence soil intake rates among children. The amount of soil ingested on a daily basis was estimated using the following equation:

$$S_{i,e} = \frac{(DW_f + DW_p)}{E_{soil}} \quad (\text{Eqn. 4-2})$$

where:

- $S_{i,e}$  = soil ingested for child i based on tracer e (g);
- $DW_f$  = feces dry weight (g);
- $DW_p$  = feces dry weight on toilet paper (g);
- $E_f$  = tracer amount in feces ( $\mu\text{g/g}$ );
- $E_u$  = tracer amount in urine ( $\mu\text{g/g}$ );
- $DW_{fd}$  = food dry weight (g);
- $E_{fd}$  = tracer amount in food ( $\mu\text{g/g}$ ); and
- $E_{soil}$  = tracer concentration in soil ( $\mu\text{g/g}$ ).

The soil intake rates were corrected by adding the amount of tracer in vitamins and medications to the amount of tracer in food, and adjusting the food quantities, feces dry weights, and tracer concentrations in urine to account for missing samples.

Soil ingestion rates were highly variable, especially those based on titanium. Mean daily soil ingestion estimates were 38.9 mg/day for aluminum, 82.4 mg/day for silicon and 245.5 mg/day for titanium (Table 4-6). Median values were 25 mg/day for aluminum, 59 mg/day for silicon, and 81 mg/day for titanium. Davis et al. (1990) also evaluated the extent to which differences in tracer concentrations in house dust and yard soil impacted estimated soil ingestion rates. The value used in the denominator of the mass balance equation was recalculated

to represent a weighted average of the tracer concentration in yard soil and house dust based on the proportion of time the child spent indoors and outdoors. The adjusted mean soil/dust intake rates were 64.5 mg/day for aluminum, 160.0 mg/day for silicon, and 268.4 mg/day for titanium. Adjusted median soil/dust intake rates were: 51.8 mg/day for aluminum, 112.4 mg/day for silicon, and 116.6 mg/day for titanium. Davis et al. (1990) also observed that the following demographic characteristics were associated with high soil intake rates: male sex, non-white racial group, low income, operator/laborer as the principal

Table 4-6. Average Daily Soil Ingestion Values Based on Aluminum, Silicon, and Titanium as Tracer Elements<sup>a</sup>

Element	Mean (mg/d)	Median (mg/d)	Standard Error of the Mean (mg/d)	Range (mg/d) <sup>b</sup>
Aluminum	38.9	25.3	14.4	279.0 to 904.5
Silicon	82.4	59.4	12.2	-404.0 to 534.6
Titanium	245.5	81.3	119.7	-5,820.8 to 6,182.2
Minimum	38.9	25.3	12.2	-5,820.8
Maximum	245.5	81.3	119.7	6,182.2

<sup>a</sup> Excludes three children who did not provide any samples (N=101).

<sup>b</sup> Negative values occurred as a result of correction for nonsoil sources of the tracer elements.

Source: Adapted from Davis et al., 1990.

occupation of the parent, and city of residence. However, none of these factors were predictive of soil intake rates when tested using multiple linear regression.

The advantages of the Davis et al. (1990) study are that soil intake rates were corrected based on the tracer content of foods and medicines and that a relatively large



Chapter 4 - Soil Ingestion and Pica

number of children were sampled. Also, demographic and behavioral information was collected for the survey group. However, although a relatively large sample population was surveyed, these children were all from a single area of the U.S. and may not be representative of the U.S. population as a whole. The study was conducted over a one-week period during the summer and may not be representative of long-term (i.e., annual) patterns of intake.

*Van Wijnen et al. (1990) - Estimated Soil Ingestion by Children* - In a study by Van Wijnen et al. (1990), soil ingestion among Dutch children ranging in age from 1 to 5 years was evaluated using a tracer element methodology similar to that used by Clausung et al. (1987). Van Wijnen et al. (1990) measured three tracers (i.e., titanium, aluminum, and AIR) in soil and feces and estimated soil ingestion based on the LTM. An average daily feces weight of 15 g dry weight was assumed. A total of 292 children attending daycare centers were sampled during the first of two sampling periods and 187 children were sampled in the second sampling period; 162

of these children were sampled during both periods (i.e., at the beginning and near the end of the summer of 1986). A total of 78 children were sampled at campgrounds, and 15 hospitalized children were sampled. The mean values for these groups were: 162 mg/day for children in daycare centers, 213 mg/day for campers and 93 mg/day for hospitalized children. Van Wijnen et al. (1990) also reported geometric mean LTM values because soil intake rates were found to be skewed and the log transformed data were approximately normally distributed. Geometric mean LTM values were estimated to be 111 mg/day for children in daycare centers, 174 mg/day for children vacationing at campgrounds (Table 4-7) and 74 mg/day for hospitalized children (70-120 mg/day based on the 95 percent confidence limits of the mean). AIR was the limiting tracer in about 80 percent of the samples. Among children attending daycare centers, soil intake was also found to be higher when the weather was good (i.e., <2 days/week precipitation) than when the weather was bad (i.e., >4 days/week precipitation (Table 4-8). Van Wijnen et al. (1990) suggest that the mean LTM value for hospitalized infants represents background intake of tracers and should be used to correct the soil intake rates based on LTM values for other sampling groups. Using mean values, corrected soil intake rates were 69 mg/day (162 mg/day minus 93 mg/day) for daycare children and 120 mg/day (213 mg/day minus 93 mg/day) for campers.

Table 4-7. Geometric Mean (GM) and Standard Deviation (GSD) LTM Values for Children at Daycare Centers and Campgrounds

Age (yrs)	Sex	Daycare Centers			Campgrounds		
		n	GM LTM (mg/day)	GSD LTM (mg/day)	n	GM LTM (mg/day)	GSD LTM (mg/day)
<1	Girls	3	81	1.09	-	-	-
	Boys	1	75	-	-	-	-
1-<2	Girls	20	124	1.87	3	207	1.99
	Boys	17	114	1.47	5	312	2.58
2-<3	Girls	34	118	1.74	4	367	2.44
	Boys	17	96	1.53	8	232	2.15
3-4	Girls	26	111	1.57	6	164	1.27
	Boys	29	110	1.32	8	148	1.42
4-<5	Girls	1	180	-	19	164	1.48
	Boys	4	99	1.62	18	136	1.30
All girls		86	117	1.70	36	179	1.67
All boys		72	104	1.46	42	169	1.79
Total		162 <sup>a</sup>	111	1.60	78 <sup>b</sup>	174	1.73

<sup>a</sup> Age and/or sex not registered for eight children.  
<sup>b</sup> Age not registered for seven children.  
 Source: Adapted from Van Wijnen et al., 1990.



Table 4-8. Estimated Geometric Mean LTM Values of Children Attending Daycare Centers According to Age, Weather Category, and Sampling Period

Weather Category	Age (years)	First Sampling Period		Second Sampling Period	
		Estimated Geometric Mean LTM Value (mg/day)		Estimated Geometric Mean LTM Value (mg/day)	
		n		n	
Bad (>4 days/week precipitation)	<1	3	94	3	67
	1-<2	18	103	33	80
	2-<3	33	109	48	91
	4-<5	5	124	6	109
Reasonable (2-3 days/week precipitation)	<1			1	61
	1-<2			10	96
	2-<3			13	99
	3-<4			19	94
Good (<2 days/week precipitation)	<1	4	102		
	1-<2	42	229		
	2-<3	65	166		
	3-<4	67	138		
	4-<5	10	132		

Source: Van Wijnen et al., 1990.

Corrected geometric mean soil intake was estimated to range from 0 to 90 mg/day with a 90th percentile value of 190 mg/day for the various age categories within the daycare group and 30 to 200 mg/day with a 90th percentile value of 300 mg/day for the various age categories within the camping group.

The advantage of this study is that soil intake was estimated for three different populations of children; one expected to have high intake, one expected to have "typical" intake, and one expected to have low or background-level intake. Van Wijnen et al. (1990) used the background tracer measurements to correct soil intake rates for the other two populations. Tracer concentrations in food and medicine were not evaluated. Also, the population of children studied was relatively large, but may not be representative of the U.S. population. This study was conducted over a relatively short time period. Thus, estimated intake rates may not reflect long-term patterns, especially at the high-end of the distribution. Another limitation of this study is that values were not reported element-by-element which would be the preferred way of reporting. In addition, one of the factors that could affect soil intake rates is hygiene (e.g., hand washing frequency). Hygienic practices can vary across countries and cultures and may be more stringently emphasized in a more

structured environment such as child care centers in The Netherlands and other European countries than in child care centers in the United States.

*Stanek and Calabrese (1995a) - Daily Estimates of Soil Ingestion in Children* - Stanek and Calabrese (1995a) presented a methodology which links the physical passage of food and fecal samples to construct daily soil ingestion estimates from daily food and fecal trace-element concentrations. Soil ingestion data for children obtained from the Amherst study (Calabrese et al., 1989) were reanalyzed by Stanek and Calabrese (1995a). In the Amherst study, soil ingestion measurements were made over a period of 2 weeks for a non-random sample of sixty-four children (ages of 1-4 years old) living adjacent to an academic area in western Massachusetts. During each week, duplicate food samples were collected for 3 consecutive days and fecal samples were collected for 4 consecutive days for each subject. The total amount of each of eight trace elements present in the food and fecal samples were measured. The eight trace elements are aluminum, barium, manganese, silicon, titanium, vanadium, yttrium, and zirconium. The authors expressed the amount of trace element in food input or fecal output as a "soil equivalent," which was defined as the amount of the element in average daily food intake (or average daily fecal output) divided by





Chapter 4 - Soil Ingestion and Pica

the concentration of the element in soil. A lag period of 28 hours between food intake and fecal output was assumed for all respondents. Day 1 for the food sample corresponded to the 24 hour period from midnight on Sunday to midnight on Monday of a study week; day 1 of the fecal sample corresponded to the 24 hour period from noon on Monday to noon on Tuesday (Stanek and Calabrese, 1995a). Based on these definitions, the food soil equivalent was subtracted from the fecal soil equivalent to obtain an estimate of soil ingestion for a trace element. A daily “overall” ingestion estimate was constructed for each child as the median of trace element values remaining after tracers falling outside of a defined range around the overall median were excluded. Additionally, estimates of the distribution of soil ingestion projected over a period of 365 days were derived by fitting log-normal distributions to the “overall” daily soil ingestion estimates.

Table 4-9 presents the estimates of mean daily soil ingestion intake per child (mg/day) for the 64 study participants. (The authors also presented estimates of the median values of daily intake for each child. For most risk assessment purposes the child mean values, which are proportional to the cumulative soil intake by the child, are needed instead of the median values.) The approach adopted in this paper led to changes in ingestion estimates from those presented in Calabrese et al. (1989).

Specifically, among elements that may be more useful for estimation of ingestion, the mean estimates decreased for Al (153 mg/d to 122 mg/d) and Si (154 mg/d to 139 mg/d), but increased for Ti (218 mg/d to 271 mg/d) and Y (85 mg/d to 165 mg/d). The “overall” mean estimate from this reanalysis was 179 mg/d. Table 4-9 presents the empirical distribution of the the “overall” mean daily soil ingestion estimates for the 8-day study period (not based on lognormal modeling). The estimated intake based on the “overall” estimates is 45 mg/day or less for 50 percent of the children and 208 mg/day or less for 95 percent of the children. The upper percentile values for most of the individual trace elements are somewhat higher. Next, estimates of the respondents soil intake averaged over a period of 365 days were presented based upon the lognormal models fit to the daily ingestion estimates (Table 4-10). The estimated median value of the 64 respondents' daily soil ingestion averaged over a year is 75 mg/day, while the 95th percentile is 1,751 mg/day.

A strength of this study is that it attempts to make full use of the collected data through estimation of daily ingestion rates for children. The data are then screened to remove less consistent tracer estimates and the remaining values are aggregated. Individual daily estimates of ingestion will be subject to larger errors than are weekly average values, particularly since the assumption of a constant lag time between food intake and fecal output may be not be correct for many subject days. The aggregation approach used to arrive at the “overall” ingestion estimates rests on the assumption that the mean

Table 4-9. Distribution of Average (Mean) Daily Soil Ingestion Estimates Per Child for 64 Children<sup>a</sup> (mg/day)

Type of Estimate Number of Samples	Overall (64)	Al (64)	Ba (33)	Mn (19)	Si (63)	Ti (56)	V (52)	Y (61)	Zr (62)
Mean	179	122	655	1,053	139	271	112	165	23
25th Percentile	10	10	28	35	5	8	8	0	0
50th Percentile	45	19	65	121	32	31	47	15	15
75th Percentile	88	73	260	319	94	93	177	47	41
90th Percentile	186	131	470	478	206	154	340	105	87
95th Percentile	208	254	518	17,374	224	279	398	144	117
Maximum	7,703	4,692	17,991	17,374	4,975	12,055	845	8,976	208

<sup>a</sup> For each child, estimates of soil ingestion were formed on days 4-8 and the mean of these estimates was then evaluated for each child. The values in the column "overall" correspond to percentiles of the distribution of these means over the 64 children. When specific trace elements were not excluded via the relative standard deviation criteria, estimates of soil ingestion based on the specific trace element were formed for 108 days for each subject. The mean soil ingestion estimate was again evaluated. The distribution of these means for specific trace elements is shown.  
Source: Stanek and Calabrese, 1995a.



ingestion estimates across acceptable tracers provides the most reliable ingestion estimates. The validity of this assumption depends on the particular set of tracers used in the study, and is not fully assessed.

Range	1 - 2,268 mg/d <sup>b</sup>
50th Percentile (median)	75 mg/d
90th Percentile	1,190 mg/d
95th Percentile	1,751 mg/d

<sup>a</sup> Based on fitting a log-normal distribution to model daily soil ingestion values.  
<sup>b</sup> Subject with pica excluded.  
Source: Stanek and Calabrese, 1995a.

In developing the 365 day soil ingestion estimates, data that were obtained over a short period of time (as is the case with all available soil ingestion studies) were extrapolated over a year. The 2-week study period may not reflect variability in tracer element ingestion over a year. While Stanek and Calabrese (1995a) attempt to address this through lognormal modeling of the long term intake, new uncertainties are introduced through the parametric modeling of the limited subject day data. Also, the sample population size of the original study was small and site limited, and, therefore, is not representative of the U.S. population. Study mean estimates of soil ingestion, such as the study mean estimates presented in Table 4-9, are substantially more reliable than any available distributional estimates.

*Stanek and Calabrese (1995b) - Soil Ingestion Estimates for Use in Site Evaluations Based on the Best Tracer Method* - Stanek and Calabrese (1995b) recalculated ingestion rates that were estimated in three previous mass-balance studies (Calabrese et al., 1989 and Davis et al., 1990 for children's soil ingestion, and Calabrese et al., 1990 for adult soil ingestion) using the Best Tracer Method (BTM). This method allows for the selection of the most recoverable tracer for a particular subject or group of subjects. The selection process involves ordering trace elements for each subject based on food/soil (F/S) ratios. These ratios are estimated by dividing the total amount of the tracer in food by the tracer concentration in soil. The F/S ratio is small when the tracer concentration in food is almost zero when compared to the tracer concentration in soil. A small F/S ratio is desirable because it lessens the impact of transit time error (the error that occurs when fecal output does not reflect food ingestion,

due to fluctuation in gastrointestinal transit time) in the soil ingestion calculation. Because the recoverability of tracers can vary within any group of individuals, the BTM uses a ranking scheme of F/S ratios to determine the best tracers for use in the ingestion rate calculation. To reduce biases that may occur as a result of sources of fecal tracers other than food or soil, the median of soil ingestion estimates based on the four lowest F/S ratios was used to represent soil ingestion among individuals.

For adults, Stanek and Calabrese (1995b) used data for 8 tracers from the Calabrese et al. (1990) study to estimate soil ingestion by the BTM. The lowest F/S ratios were Zr and Al and the element with the highest F/S ratio was Mn. For soil ingestion estimates based on the median of the lowest four F/S ratios, the tracers contributing most often to the soil ingestion estimates were Al, Si, Ti, Y, V, and Zr. Using the median of the soil ingestion rates based on the best four tracer elements, the average adult soil ingestion rate was estimated to be 64 mg/day with a median of 87 mg/day. The 90th percentile soil ingestion estimate was 142 mg/day. These estimates are based on 18 subject weeks for the six adult volunteers described in Calabrese et al. (1990).

For children, Stanek and Calabrese (1995b) used data on 8 tracers from Calabrese et al., 1989 and data on 3 tracers from Davis et al. (1990) to estimate soil ingestion rates. The median of the soil ingestion estimates from the lowest four F/S ratios from the Calabrese et al. (1989) study most often included Al, Si, Ti, Y, and Zr. Based on the median of soil ingestion estimates from the best four tracers, the mean soil ingestion rate was 132 mg/day and the median was 33 mg/day. The 95th percentile value was 154 mg/day. These estimates are based on data for 128 subject weeks for the 64 children in the Calabrese et al. (1989) study. For the 101 children in the Davis et al. (1990) study, the mean soil ingestion rate was 69 mg/day and the median soil ingestion rate was 44 mg/day. The 95th percentile estimate was 246 mg/day. These data are based on the three tracers (i.e., Al, Si, and Ti) from the Davis et al. (1990) study. When the Calabrese et al. (1989) and Davis et al. (1990) studies were combined, soil ingestion was estimated to be 113 mg/day (mean); 37 mg/day (median); and 217 mg/day (95th percentile), using the BTM.

This study provides a reevaluation of previous studies. Its advantages are that it combines data from 2 studies for children, one from California and one from Massachusetts, which increases the number of observations. It also corrects for biases associated with the differences in tracer metabolism. The limitations associated with the data



used in this study are the same as the limitations described in the summaries of the Calabrese et al. (1989), Davis et al. (1990) and Calabrese et al. (1990) studies.

### **4.3. RELEVANT STUDIES ON SOIL INTAKE AMONG CHILDREN**

*Lepow et al. (1975) - Investigations Into Sources of Lead in the Environment of Urban Children* - Lepow et al. (1975) used data from a previous study (Lepow et al., 1974) to estimate daily soil ingestion rates of children. Lepow et al. (1974) estimated ingestion of airborne lead fallout among urban children by: (1) analyzing surface dirt and dust samples from locations where children played; (2) measuring hand dirt by applying preweighed adhesive labels to the hands and weighing the amount of dirt that was removed; and (3) observing "mouthing" behavior over 3 to 6 hours of normal play. Twenty-two children from an urban area of Connecticut were included in the study. Lepow et al. (1975) used data from the 1974 study and found that the mean weight of soil/dust on the hands was 11 mg. Assuming that a child would put fingers or other "dirty" objects into his mouth about 10 times a day ingesting 11 mg of dirt each time, Lepow et al. (1975) estimated that the daily soil ingestion rate would be about 100 mg/day. According to Lepow et al. (1975), the amount of hand dirt measured with this technique is probably an underestimate because dirt trapped in skin folds and creases was probably not removed by the adhesive label. Consequently, mean soil ingestion rates may be somewhat higher than the values estimated in this study.

*Day et al. (1975) - Lead in Urban Street Dust* - Day et al. (1975) evaluated the contribution of incidental ingestion of lead-contaminated street dust and soil to children's total daily intake of lead by measuring the amount of lead in street dust and soil and estimating the amount of dirt ingested by children. The amount of soil that might be ingested was estimated by measuring the amount of dirt that was transferred to a "sticky sweet" during 30 minutes of play and assuming that a child might eat from 2 to 20 such sweets per day. Based on "a small number of direct measurements," Day et al. (1975) found that 5 to 50 mg of dirt from a child's hands may be transferred to a "sticky sweet" during 30 minutes of "normal playground activity. Assuming that all of the dirt is ingested with the 2 to 20 "sticky sweets," Day et al. (1975) estimated that intake of soil among children could range from 10 to 1000 mg/day.

*Duggan and Williams (1977) - Lead in Dust in City Streets* - Duggan and Williams (1977) assessed the risks associated with lead in street dust by analyzing street dust

from areas in and around London for lead, and estimating the amount of hand dirt that a child might ingest. Duggan and Williams (1977) estimated the amount of dust that would be retained on the forefinger and thumb by removing a small amount of dust from a weighed amount, rubbing the forefinger and thumb together, and reweighing to determine the amount retained on the finger and thumb. The results of "a number of tests with several different people" indicated that the mean amount of dust retained on the finger and thumb was approximately 4 mg with a range of 2 to 7 mg (Duggan and Williams, 1977). Assuming that a child would suck his/her finger or thumb 10 times a day and that all of the dirt is removed each time and replaced with new dirt prior to subsequent mouthing behavior, Duggan and Williams (1977) estimated that 20 mg of dust would be ingested per day.

*Hawley et al. (1985) - Assessment of Health Risk from Exposure to Contaminated Soil* - Using existing literature, Hawley (1985) developed scenarios for estimating exposure of young children, older children, and adults to contaminated soil. Annual soil ingestion rates were estimated based on assumed intake rates of soil and housedust for indoor and outdoor activities and assumptions about the duration and frequency of the activities. These soil ingestion rates were based on the assumption that the contaminated area is in a region having a winter season. Housedust was assumed to be comprised of 80 percent soil.

Outdoor exposure to contaminated soil among young children (i.e., 2.5 years old) was assumed to occur 5 days per week during only 6 months of the year (i.e., mid-April through mid-October). Children were assumed to ingest 250 mg soil/day while playing outdoors based on data presented in Lepow et al. (1974; 1975) and Roels et al. (1980). Indoor exposures among this population were based on the assumption that young children ingest 100 mg of housedust per day while spending all of their time indoors during the winter months, and 50 mg of housedust per day during the warmer months when only a portion of their time is spent indoors. Based on these assumptions, Hawley (1985) estimated that the annual average soil intake rate for young children is 150 mg/day (Table 4-11). Older children (i.e., 6 year olds) were assumed to ingest 50 mg of soil per day from an area equal to the area of the



Table 4-11. Estimates of Soil Ingestion for Children

Scenarios	Media	Exposure (mg/day)	Days/Year Activity	Fraction Soil Content	Annual Average Soil Intake (mg/day)
<u>Young Child (2.5 Years Old)</u>					
Outdoor Activities (Summer)	Soil	250	130	1	90
Indoor Activities (Summer)	Dust	50	182	0.8	20
Indoor Activities (Winter)	Dust	100	182	0.8	40
TOTAL SOIL INTAKE					150
<u>Older Child (6 Years Old)</u>					
Outdoor Activities (Summer)	Soil	50	152	1	21
Indoor Activities (Year-Round)	Dust	3	365	0.8	2.4
TOTAL SOIL INTAKE					23.4

Source: Hawley, 1985.

fingers on one hand while playing outdoors. This assumption was based on data from Lepow et al. (1975). Outdoor activities were assumed to occur each day over 5 months of the year (i.e., during May through October). These children were also assumed to ingest 3 mg/day of housedust from the indoor surfaces of the hands during indoor activities occurring over the entire year. Using these data, Hawley (1985) estimated the annual average soil intake rate for older children to be 23.4 mg/day (Table 4-11).

*Thompson and Burmaster (1991) - Parametric Distributions for Soil Ingestion by Children* - Thompson and Burmaster (1991) developed parameterized distributions of soil ingestion rates for children based on a reanalysis of the data collected by Binder et al. (1986). In the original Binder et al. (1986) study, an assumed fecal weight of 15 g/day was used. Thompson and Burmaster reestimated the soil ingestion rates from the Binder et al. (1986) study using the actual stool weights of the study participants instead of the assumed stool weights. Because the actual stool weights averaged only 7.5 g/day, the soil ingestion estimates presented by Thompson and Burmaster (1991) are approximately one-half of those reported by Binder et al. (1986). Table 4-12 presents the distribution of estimated soil ingestion rates calculated by Thompson and Burmaster (1991) based on the three tracers elements (i.e., aluminum, silicon, and titanium), and on the arithmetic average of soil ingestion based on aluminum and silicon. The mean soil intake rates were 97 mg/day for aluminum, 85 mg/day for silicon, and 1,004 mg/day for titanium. The 90th percentile estimates were 197 mg/day for aluminum, 166 mg/day for silicon, and 2,105 mg/day for titanium. Based on the arithmetic average of aluminum and silicon for

each child, mean soil intake was estimated to be 91 mg/day and 90th percentile intake was estimated to be 143 mg/day.

Thompson and Burmaster (1991) tested the hypothesis that soil ingestion rates based on the adjusted Binder et al. (1986) data for aluminum, silicon and the average of these two tracers were lognormally distributed. The distribution of soil intake based on titanium was not tested for lognormality because titanium may be present in food in high concentrations and the Binder et al. (1986) study did not correct for food sources of titanium (Thompson and Burmaster, 1991). Although visual inspection of the distributions for aluminum, silicon, and the average of these tracers all indicated that they may be lognormally distributed, statistical tests indicated that only silicon and the average of the silicon and aluminum tracers were lognormally distributed. Soil intake rates based on aluminum were not lognormally distributed. Table 4-12 also presents the lognormal distribution parameters and underlying normal distribution parameters (i.e., the natural logarithms of the data) for aluminum, silicon, and the average of these two tracers. According to the authors, "the parameters estimated from the underlying normal distribution are much more reliable and robust" (Thompson and Burmaster, 1991).

The advantages of this study are that it provides percentile data and defines the shape of soil intake distributions. However, the number of data points used to fit the distribution was limited. In addition, the study did not generate "new" data. Instead, it provided a reanalysis of previously-reported data using actual fecal weights. No corrections were made for tracer intake from food or



Table 4-12. Estimated Soil Ingestion Rate Summary Statistics and Parameters for Distributions Using Binder et al. (1986) Data with Actual Fecal Weights

Trace Element Basis	Soil Intake (mg/day)			
	Al	Si	Ti	MEAN <sup>a</sup>
Mean	97	85	1,004	91
Min	11	10	1	13
10th	21	19	3	22
20th	33	23	22	34
30th	39	36	47	43
40th	43	52	172	49
Med	45	60	293	59
60th	55	65	475	69
70th	73	79	724	92
80th	104	106	1,071	100
90th	197	166	2,105	143
Max	1,201	642	14,061	921
<i>Lognormal Distribution Parameters</i>				
Median	45	60	--	59
Standard Deviation	169	95	--	126
Arithmetic Mean	97	85	--	91
<i>Underlying Normal Distribution Parameters</i>				
Mean	4.06	4.07	--	4.13
Standard Deviation	0.88	0.85	--	0.80

<sup>a</sup> MEAN = arithmetic average of soil ingestion based on aluminum and silicon.  
Source: Thompson and Burmaster, 1991.

medicine and the results may not be representative of long-term intake rates because the data were derived from a short-term study.

*Sedman and Mahmood (1994) - Soil Ingestion by Children and Adults Reconsidered Using the Results of Recent Tracer Studies* - Sedman and Mahmood (1994) used the results of two recent children's (Calabrese et al. 1989; Davis et al. 1990) tracer studies to determine estimates of average daily soil ingestion in young children and for over a lifetime. In the two studies, the intake and excretion of a variety of tracers were monitored, and concentrations of tracers in soil adjacent to the children's dwellings were determined (Sedman and Mahmood, 1994). From a mass balance approach, estimates of soil ingestion in these children were determined by dividing the excess tracer intake (i.e., quantity of tracer recovered in the feces in excess of the measured intake) by the average concentration of tracer in soil samples from each child's dwelling. Sedman and Mahmood (1994) adjusted the mean estimates of soil ingestion in children for each tracer (Y) from both studies to reflect that of a 2-year old child using the following equation:

$$Y_i = x e^{(-0.112 \cdot yr)} \quad (\text{Eqn. 4-3})$$

where:

- Y<sub>i</sub> = adjusted mean soil ingestion (mg/day)
- x = a constant
- yr = average age (2 years)

In addition to the study in young children, a study (Calabrese et al., 1989) in adults was conducted to evaluate the tracer methodology. In the adult studies, percent recoveries of tracers were determined in six adults who ingested known quantities of tracers in 1.5 or 0.3 grams of soil. The distribution of tracer recoveries from adults was evaluated using data analysis techniques involving visualization and exploratory data analysis (Sedman and Mahmood, 1994). From the results obtained in these studies, the distribution of tracer recoveries from adults were determined. In addition, an analysis of variance (ANOVA) and Tukey's multiple comparison methodologies



were employed to identify differences in the recoveries of the various tracers (Sedman and Mahmood, 1994).

From the adult studies, the ANOVA of the natural logarithm of the recoveries of tracers from 0.3 or 1.5 g of ingested soil showed a significant difference ( $\alpha = 0.05$ ) among the estimates of recovery of the tracers regardless of whether the recoveries were combined or analyzed separately (Sedman and Mahmood, 1994). Sedman and Mahmood (1994) also reported that barium, manganese, and zirconium yielded significantly different estimates of soil ingestion than the other tracers (aluminum, silicon, yttrium, titanium, and vanadium). Table 4-13 presents the Tukey's multiple comparison of mean log tracer recovery in adults ingesting known quantities of soil.

The average ages of children in the two recent studies were 2.4 years in Calabrese, et al. (1989) and 4.7 years in Davis et al. (1990). The mean of the adjusted levels of soil ingestion for a two year old child was 220 mg/kg for the Calabrese et al. (1989) study and 170 mg/kg for the Davis et al. (1990) study (Sedman and Mahmood, 1994). From the adjusted soil ingestion estimates, based on a normal distribution of means, the mean estimate for a 2-year old child was 195 mg/day and the overall mean of soil ingestion and the standard error of the mean was 53 mg/day (Sedman and Mahmood, 1994). Based on uncertainties associated with the method employed, Sedman and Mahmood (1994) recommended a conservative estimate of soil ingestion in young children of 250 mg/day. Based on the 250 mg/day ingestion rate

in a 2-year old child, an average daily soil ingestion over a lifetime was estimated to be 70 mg/day. The lifetime estimates were derived using the equation presented above that describes changes in soil ingestion with age (Sedman and Mahmood, 1994).

*AIHC Exposure Factors Sourcebook (1994)* - The Exposure Factors Sourcebook (AIHC, 1994) uses data from the Calabrese et al. (1990) study to derive soil ingestion rates using zirconium as the tracer. More recent papers indicate that zirconium is not a good tracer. Therefore, the values recommended in the AIHC Sourcebook are not appropriate. Furthermore, because individuals were only studied for a short period of time, deriving a distribution of usual intake is not possible and is inappropriate.

*Calabrese and Stanek (1995) - Resolving Intertracer Inconsistencies in Soil Ingestion Estimation* - Calabrese and Stanek (1995) explored sources and magnitude of positive and negative errors in soil ingestion estimates for children on a subject-week and trace element basis. Calabrese and Stanek (1995) identified possible sources of positive errors to be the following:

- Ingestion of high levels of tracers before the study starts and low ingestion during study period may result in over estimation of soil ingestion; and
- Ingestion of element tracers from a non-food or non-soil source during the study period.

Table 4-13. Tukey's Multiple Comparison of Mean Log Tracer Recovery in Adults Ingesting Known Quantities of Soil		
Tracer	Reported Mean (mg/day)	Age Adjusted Mean (mg/day)
Calabrese et al., 1989 Study		
Aluminum	153	160
Silicon	154	161
Titanium	218	228
Vanadium	459	480
Yttrium	85	89
Davis et al., 1990 Study		
Aluminum	39	53
Silicon	81	111
Titanium	246	333
<sup>a</sup> Age adjusted mean estimates of soil ingestion in young children. Mean estimates of soil ingestion for each tracer in each study were adjusted using the following equation: $Y = x e^{(-0.112 * yr)}$ , where Y = adjusted mean soil ingestion (mg/day), x = a constant, and yr = age in years. Source: Sedman and Mahmood, 1994.		



Chapter 4 - Soil Ingestion and Pica

Possible sources of negative bias identified by Calabrese and Stanek (1995) are the following:

- Ingestion of tracers in food, but the tracers are not captured in the fecal sample either due to slow lag time or not having a fecal sample available on the final study day; and
- Sample measurement errors which result in diminished detection of fecal tracers, but not in soil tracer levels.

The authors developed an approach which attempted to reduce the magnitude of error in the individual trace element ingestion estimates. Results from a previous study conducted by Calabrese et al. (1989) were used to quantify these errors based on the following criteria: (1) a lag period of 28 hours was assumed for the passage of tracers ingested in food to the feces (this value was applied to all subject-day estimates); (2) daily soil ingestion rate was estimated for each tracer for each 24-hr day a fecal sample was obtained; (3) the median tracer-based soil ingestion rate for each subject-day was determined. Also, upper and lower bound estimates were determined based on criteria formed using an assumption of the magnitude of the relative standard deviation (RSD) presented in another study conducted by Stanek and Calabrese (1995a). Daily soil ingestion rates for tracers that fell beyond the upper and lower ranges were excluded from subsequent calculations, and the median soil ingestion rates of the remaining tracer elements were

considered the best estimate for that particular day. The magnitude of positive or negative error for a specific tracer per day was derived by determining the difference between the value for the tracer and the median value; (4) negative errors due to missing fecal samples at the end of the study period were also determined (Calabrese and Stanek, 1995).

Table 4-14 presents the estimated magnitude of positive and negative error for six tracer elements in the children's study (i.e., conducted by Calabrese et al., 1989). The original mean soil ingestion rates ranged from a low of 21 mg/day based on zirconium to a high of 459 mg/day based on titanium (Table 4-14). The adjusted mean soil ingestion rate after correcting for negative and positive errors ranged from 97 mg/day based on yttrium to 208 mg/day based on titanium (Table 4-14). Calabrese and Stanek (1995) concluded that correcting for errors at the individual level for each tracer element provides more reliable estimates of soil ingestion.

This report is valuable in providing additional understanding of the nature of potential errors in trace element specific estimates of soil ingestion. However, the operational definition used for estimating the error in a trace element estimate was the observed difference of that tracer from a median tracer value. Specific identification of sources of error, or direct evidence that individual tracers were indeed in error was not developed. Corrections to individual tracer means were then made according to how different values for that tracer were from the median values. This approach is based on the hypothesis that the median tracer value is the most

Table 4-14. Positive/Negative Error (bias) in Soil Ingestion Estimates in the Calabrese et al. (1989) Mass-balance Study: Effect on Mean Soil Ingestion Estimate (mg/day) <sup>a</sup>							
Negative Error							
	Lack of Fecal Sample on Final Study Day	Other Causes <sup>b</sup>	Total Negative Error	Total Positive Error	Net Error	Original Mean	Adjusted Mean
Aluminum	14	11	25	43	+18	153	136
Silicon	15	6	21	41	+20	154	133
Titanium	82	187	269	282	+13	218	208
Vanadium	66	55	121	432	+311	459	148
Yttrium	8	26	34	22	-12	85	97
Zirconium	6	91	97	5	-92	21	113

<sup>a</sup> How to read table: for example, aluminum as a soil tracer displayed both negative and positive error. The cumulative total negative error is estimated to bias the mean estimate by 25 mg/day downward. However, aluminum has positive error biasing the original mean upward by 43 mg/day. The net bias in the original mean was 18 mg/day positive bias. Thus, the original 156 mg/day mean for aluminum should be corrected downward to 136 mg/day.

<sup>b</sup> Values indicate impact on mean of 128-subject-weeks in milligrams of soil ingested per day.

Source: Calabrese and Stanek, 1995.



accurate estimate of soil ingestion, and the validity of this assumption depends on the specific set of tracers used in the study and need not be correct. The approach used for the estimation of daily tracer intake is the same as in Stanek and Calabrese (1995a), and some limitations of that approach are mentioned in the review of that study.

*Sheppard (1995) - Parameter Values to Model the Soil Ingestion Pathway* - Sheppard (1995) summarized the available literature on soil ingestion to estimate the amount of soil ingestion in humans for the purposes of risk assessment. Sheppard (1995) categorized the available soil ingestion studies into two general approaches: (1) those that measured the soil intake rate with the use of tracers in the soil, and (2) those that estimated soil ingestion based on activity (e.g., hand-to-mouth) and exposure duration. Sheppard (1995) provided estimates of soil intake based on previously published tracer studies. The data from these studies were assumed to be lognormally distributed due to the broad range, the concept that soil ingestion is never zero, and the possibility of very high values. In order to account for skewness in the data, geometric means rather than arithmetic means, were calculated by age, excluding pica and geophagy values. The geometric mean for soil ingestion rate for children under six was estimated to be 100 mg/day. For children over six and adults, the geometric mean intake rate was estimated to be 20 mg/day. Sheppard (1995) also provided soil ingestion estimates for indoor and outdoor activities based on data from Hawley (1985) and assumptions regarding duration of exposure (Table 4-15).

Sheppard's (1995) estimates, based on activity and exposure duration, are quite similar to the mean values from intake rate estimates described in previous sections. The advantages of this study are that the model can be used to calculate the ingestion rate from non-food sources with variability in exposure ingestion rates and exposure durations. The limitation of this study is that it does not introduce new data; previous data are re-evaluated. In addition, because the model is based on previous data, the same advantages and limitations of those studies apply.

#### 4.4. SOIL INTAKE AMONG ADULTS

*Hawley 1985 - Assessment of Health Risk from Exposure to Contaminated Soil* - Information on soil ingestion among adults is very limited. Hawley (1985) estimated soil ingestion among adults based on assumptions regarding activity patterns and corresponding ingestion amounts. Hawley (1985) assumed that adults ingest outdoor soil at a rate of 480 mg/day while engaged in yardwork or other physical activity. These outdoor exposures were assumed to occur 2 days/week during 5 months of the year (i.e., May through October). The ingestion estimate was based on the assumption that a 50  $\mu$ m thick layer of soil is ingested from the inside surfaces of the thumb and fingers of one hand. Ingestion of indoor housedust was assumed to occur from typical living space activities such as eating and smoking, and work in attics or other uncleaned areas of the house. Hawley (1985) assumed that adults ingest an average of 0.56 mg housedust/day during typical living space activities and 110 mg housedust/day while working in attics. Attic work

Table 4-15. Soil Ingestion Rates for Assessment Purposes

Receptor Age	Setting	Soil Load on Hands (mg/cm <sup>2</sup> )	Soil Exposure Ingestion Rate (mg/hr)	Suggested Exposure Durations (hr/yr)	Average Daily Soil Ingestion (mg/day)
Pica Child		---	1,000	200	500
2.5 yrs	Outdoor	0.5	20	1,000	50
	Indoor	0.4	3	Remaining <sup>a</sup>	60
6 yrs	Outdoor	0.5	10	700	20
	Indoor	0.04	0.15	5,000	2
Adult	Gardening	1.0	20	300	20
	Indoor	0.04	0.03	5,000	0.4

<sup>a</sup> Hawley (1985) assumed the child spent all the time at home, so that the indoor time was 8,760 hours/year minus the outdoor time.

Source: Sheppard, 1995

was assumed to occur 12 days/year. Hawley (1985) also assumed that soil comprises 80 percent of household dust.

Based on these assumptions about soil intake and the frequency of indoor and outdoor activities, Hawley (1985)





Chapter 4 - Soil Ingestion and Pica

estimated the annual average soil intake rate for adults to be 60.5 mg/day (Table 4-16).

The soil intake value estimated by Hawley (1985) is consistent with adult soil intake rates suggested by other researchers. Calabrese et al. (1987) suggested that soil intake among adults ranges from 1 to 100 mg/day.

during each of the 3 weeks. In addition, all medications and vitamins ingested by the adults were collected. Total excretory output were collected from Monday noon through Friday midnight over 3 consecutive weeks. Table 4-17 provides the mean and median values of soil ingestion for each element by week. Data obtained from the first week,

Table 4-16. Estimates of Soil Ingestion for Adults

Scenarios	Media	Exposure (mg/day)	Days/Year Activity	Fraction Soil Content	Annual Average Soil Intake (mg/day)
<u>Adult</u>					
Work in attic (year-round)	Dust	110	12	0.8	3
Living Space (year-round)	Dust	0.56	365	0.8	0.5
Outdoor Work (summer)	Soil	480	43	1	<u>57</u>
<b>TOTAL SOIL INTAKE</b>					<b>60.5</b>

Source: Hawley, 1985.

According to Calabrese et al. (1987), these values "are conjectural and based on fractional estimates" of earlier Center for Disease Control (CDC) estimates. In an evaluation of the scientific literature concerning soil ingestion rates for children and adults (Krablin, 1989), Arco Coal Company suggested that 10 mg/day may be an appropriate value for adult soil ingestion. This value is based on "extrapolation from urine arsenic epidemiological studies and information on mouthing behavior and time activity patterns" (Krablin, 1989).

Calabrese et al. (1990) - Preliminary Adult Soil Ingestion Estimates: Results of a Pilot Study- Calabrese et al. (1990) studied six adults to evaluate the extent to which they ingest soil. This adult study was originally part of the children soil ingestion study conducted by Calabrese and was used to validate part of the analytical methodology used in the children study. The participants were six healthy adults, three males and three females, 25-41 years old. Each volunteer ingested one empty gelatin capsule at breakfast and one at dinner Monday, Tuesday, and Wednesday during the first week of the study. During the second week, they ingested 50 mg of sterilized soil within a gelatin capsule at breakfast and at dinner (a total of 100 mg of sterilized soil per day) for 3 days. For the third week, the participants ingested 250 mg of sterilized soil in a gelatin capsule at breakfast and at dinner (a total of 500 mg of soil per day) during the three days. Duplicate meal samples (food and beverage) were collected from the six adults. The sample included all foods ingested from breakfast Monday, through the evening meal Wednesday

when empty gelatin capsules were ingested, may be used to derive an estimate of soil intake by adults. The mean intake rates for the eight tracers are: Al, 110 mg; Ba, -232 mg; Mn, 330 mg; Si, 30 mg; Ti, 71 mg; V, 1,288 mg; Y, 63 mg; and Zr, 134 mg.

The advantage of this study is that it provides quantitative estimates of soil ingestion for adults. The study also corrected for tracer concentrations in foods and medicines. However, a limitation of this study is that a limited number of subjects were studied. In addition, the subjects were only studied for one week before soil capsules were ingested.

4.5. PREVALENCE OF PICA

The scientific literature define pica as "the repeated eating of non-nutritive substances" (Feldman, 1986). For the purposes of this handbook, pica is defined as an deliberately high soil ingestion rate. Numerous articles have been published that report on the incidence of pica among various populations. However, most of these papers describe pica for substances other than soil including sand, clay, paint, plaster, hair, string, cloth, glass, matches, paper, feces, and various other items. These papers indicate that the pica occurs in approximately half of all children



Week	Al	Ba	Mn	Si	Ti	V	Y	Zr
Means								
1	110	-232	330	30	71	1,288	63	134
2	98	12,265	1,306	14	25	43	21	58
3	28	201	790	-23	896	532	67	-74
Medians								
1	60	-71	388	31	102	1,192	44	124
2	85	597	1,368	15	112	150	35	65
3	66	386	831	-27	156	047	60	-144

<sup>a</sup> Data were converted to milligrams  
<sup>b</sup> Negative values occur because of correction for food and capsule ingestion.  
Source: Calabrese et al., 1990

between the ages of 1 and 3 years (Sayetta, 1986). The incidence of deliberate ingestion behavior in children has been shown to differ for different subpopulations. The incidence rate appears to be higher for black children than for white children. Approximately 30 percent of black children aged 1 to 6 years are reported to have deliberate ingestion behavior, compared with 10 to 18 percent of white children in the same age group (Danford, 1982). There does not appear to be any sex differences in the incidence rates for males or females (Kaplan and Sadock, 1985). Lourie et al. (1963) states that the incidence of pica is higher among children in lower socioeconomic groups (i.e., 50 to 60 percent) than in higher income families (i.e., about 30 percent). Deliberate soil ingestion behavior appears to be more common in rural areas (Vermeer and Frate, 1979). A higher rate of pica has also been reported for pregnant women and individuals with poor nutritional status (Danford, 1982). In general, deliberate ingestion behavior is more frequent and more severe in mentally retarded children than in children in the general population (Behrman and Vaughan 1983, Danford 1982, Forfar and Arneil 1984, Illingworth 1983, Sayetta 1986).

It should be noted that the pica statistics cited above apply to the incidence of general pica and not soil pica. Information on the incidence of soil pica is limited, but it appears that soil pica is less common. A study by Vermeer and Frate (1979) showed that the incidence of geophagia (i.e., earth-eating) was about 16 percent among children from a rural black community in Mississippi. However, geophagia was described as a cultural practice among the community surveyed and may not be representative of the general population. Average daily consumption of soil was estimated to be 50 g/day. Bruhn and Pangborn (1971) reported the incidence of pica for "dirt" to be 19 percent in children, 14 percent in pregnant women, and 3 percent in

nonpregnant women. However, "dirt" was not clearly defined. The Bruhn and Pangborn (1971) study was conducted among 91 non-black, low income families of migrant agricultural workers in California. Based on the data from the five key tracer studies (Binder et al., 1986; Clausing et al., 1987; Van Wijnen et al., 1990; Davis et al., 1990; and Calabrese et al., 1989) only one child out of the more than 600 children involved in all of these studies ingested an amount of soil significantly greater than the range for other children. Although these studies did not include data for all populations and were representative of short-term ingestions only, it can be assumed that the incidence rate of deliberate soil ingestion behavior in the general population is low. However, it is incumbent upon the user to use the appropriate value for their specific study population.

#### 4.6. DELIBERATE SOIL INGESTION AMONG CHILDREN

Information on the amount of soil ingested by children with abnormal soil ingestion behavior is limited. However, some evidence suggests that a rate on the order of 10 g/day may not be unreasonable.

*Calabrese et al. (1991) - Evidence of Soil Pica Behavior and Quantification of Soil Ingestion* - Calabrese et al. (1991) estimated that upper range soil ingestion values may range from approximately 5-7 grams/day. This estimate was based on observations of one pica child among the 64 children who participated in the study. In the study, a 3.5-year old female exhibited extremely high soil ingestion behavior during one of the two weeks of observation. Intake ranged from 74 mg/day to 2.2 g/day during the first week of observation and 10.1 to 13.6 g/day during the second week of observation (Table 4-18). These results are based on mass-balance analyses for seven (i.e.,



Chapter 4 - Soil Ingestion and Pica

aluminum, barium, manganese, silicon, titanium, vanadium, and yttrium) of the eight tracer elements used. Intake rates based on zirconium was significantly lower but Calabrese et al. (1991) indicated that this may have "resulted from a limitation in the analytical protocol."

Table 4-18. Daily Soil Ingestion Estimation in a Soil-Pica Child by Tracer and by Week (mg/day)

Tracer	Week 1	Week 2
	Estimated Soil Ingestion	Estimated Soil Ingestion
Al	74	13,600
Ba	458	12,088
Mn	2,221	12,341
Si	142	10,955
Ti	1,543	11,870
V	1,269	10,071
Y	147	13,325
Zr	86	2,695

Source: Calabrese et al., 1991

Calabrese and Stanek (1992) - Distinguishing Outdoor Soil Ingestion from Indoor Dust Ingestion in a Soil Pica Child - Calabrese and Stanek (1992) quantitatively distinguished the amount of outdoor soil ingestion from indoor dust ingestion in a soil pica child. This study was based on a previous mass-balance study (conducted in 1991) in which a 3-1/2 year old child

ingested 10-13 grams of soil per day over the second week of a 2-week soil ingestion study. Also, the previous study utilized a soil tracer methodology with eight different tracers (Al, Ba, Mn, Si, Ti, V, Y, Zr). The reader is referred to Calabrese et al. (1989) for a detailed description and results of the soil ingestion study. Calabrese and Stanek (1992) distinguished indoor dust from outdoor soil in ingested soil based on a methodology which compared differential element ratios.

Table 4-19 presents tracer ratios of soil, dust, and residual fecal samples in the soil pica child. Calabrese and Stanek (1992) reported that there was a maximum total of 28 pairs of tracer ratios based on eight tracers. However, only 19 pairs of tracer ratios were available for quantitative evaluation as shown in Table 4-19. Of these 19 pairs, 9 fecal tracer ratios fell within the boundaries for soil and dust (Table 4-19). For these 9 tracer soils, an interpolation was performed to estimate the relative contribution of soil and dust to the residual fecal tracer ratio. The other 10 fecal tracer ratios that fell outside the soil and dust boundaries were concluded to be 100 percent of the fecal tracer ratios from soil origin (Calabrese and Stanek, 1992). Also, the 9 residual fecal samples within the boundaries revealed that a high percentage (71-99 percent) of the residual fecal tracers were estimated to be of soil origin. Therefore, Calabrese and Stanek (1992) concluded that the predominant proportion of the fecal tracers was from outdoor soil and not from indoor dust origin.

Table 4-19. Ratios of Soil, Dust, and Residual Fecal Samples in the Soil Pica Child

Tracer Ratio Pairs	Soil	Fecal	Dust	Estimated % of Residual Fecal Tracers of Soil Origin as Predicted by Specific Tracer Ratios
1. Mn/Ti	208.368	215.241	260.126	87
2. Ba/Ti	187.448	206.191	115.837	100
3. Si/Ti	148.117	136.662	7.490	92
4. V/Ti	14.603	10.261	17.887	100
5. Al/Ti	18.410	21.087	13.326	100
6. Y/Ti	8.577	9.621	5.669	100
7. Mn/Y	24.293	22.373	45.882	100
8. Ba/Y	21.854	21.432	20.432	71
9. Si/Y	17.268	14.205	1.321	81
10. V/Y	1.702	1.067	3.155	100
11. Al/Y	2.146	2.192	2.351	88
12. Mn/Al	11.318	10.207	19.520	100
13. Ba/Al	10.182	9.778	8.692	73
14. Si/Al	8.045	6.481	0.562	81
15. V/Al	0.793	0.487	1.342	100
16. Si/V	10.143	13.318	0.419	100
17. Mn/Si	1.407	1.575	34.732	99
18. Ba/Si	1.266	1.509	15.466	83
19. Mn/Ba	1.112	1.044	2.246	100

Source: Calabrese and Stanek, 1992.



In conducting a risk assessment for TCDD, U.S. EPA (1984) used 5 g/day to represent the soil intake rate for pica children. The Centers for Disease Control (CDC) also investigated the potential for exposure to TCDD through the soil ingestion route. CDC used a value of 10 g/day to represent the amount of soil that a child with deliberate soil ingestion behavior might ingest (Kimbrough et al., 1984). These values are consistent with those observed by Calabrese et al. (1991).

#### **4.7. RECOMMENDATIONS**

The key studies described in this section were used to recommend values for soil intake among children. The key and relevant studies used different survey designs and study populations. These studies are summarized in Table 4-20. For example, some of the studies considered food and nonfood sources of trace elements, while others did not. In other studies, soil ingestion estimates were adjusted to account for the contribution of house dust to this estimate. Despite these differences, the mean and upper-percentile estimates reported for these studies are relatively consistent. The confidence rating for soil intake recommendations is presented in Table 4-21.

It is important, however, to understand the various uncertainties associated with these values. First, individuals were not studied for sufficient periods of time to get a good estimate of the usual intake. Therefore, the values presented in this section may not be representative of long term exposures. Second, the experimental error in measuring soil ingestion values for individual children is also a source of uncertainty. For example, incomplete sample collection of both input (i.e., food and nonfood sources) and output (i.e., urine and feces) is a limitation for some of the studies conducted. In addition, an individual's soil ingestion value may be artificially high or low depending on the extent to which a mismatch between input and output occurs due to individual variation in the gastrointestinal transit time. Third, the degree to which the tracer elements used in these studies are absorbed in the human body is uncertain. Accuracy of the soil ingestion estimates depends on how good this assumption is. Fourth, there is uncertainty with regard to the homogeneity of soil samples and the accuracy of parent's knowledge about their child's playing areas. Fifth, all the soil ingestion studies presented in this section with the exception of Calabrese et al. (1989) were conducted during the summer when soil contact is more likely.

Although the recommendations presented below are derived from studies which were mostly conducted in the

summer, exposure during the winter months when the ground is frozen or snow covered should not be considered as zero. Exposure during these months, although lower than in the summer months, would not be zero because some portion of the house dust comes from outdoor soil.

*Soil Ingestion Among Children* - Estimates of the amount of soil ingested by children are summarized in Table 4-22. The mean values ranged from 39 mg/day to 271 mg/day with an average of 146 mg/day for soil ingestion and 191 mg/day for soil and dust ingestion. Results obtained using titanium as a tracer in the Binder et al. (1986) and Clausing et al. (1987) studies were not considered in the derivation of this recommendation because these studies did not take into consideration other sources of the element in the diet which for titanium seems to be significant. Therefore, these values may overestimate the soil intake. One can note that this group of mean values is consistent with the 200 mg/day value that EPA programs have used as a conservative mean estimate. Taking into consideration that the highest values were seen with titanium, which may exhibit greater variability than the other tracers, and the fact that the Calabrese et al. (1989) study included a pica child, 100 mg/day is the best estimate of the mean for children under 6 years of age. However, since the children were studied for short periods of time and the prevalence of pica behavior is not known, excluding the pica child from the calculations may underestimate soil intake rates. It is plausible that many children may exhibit some pica behavior if studied for longer periods of time. Over the period of study, upper percentile values ranged from 106 mg/day to 1,432 mg/day with an average of 383 mg/day for soil ingestion and 587 mg/day for soil and dust ingestion. Rounding to one significant figure, the recommended upper percentile soil ingestion rate for children is 400 mg/day. However, since the period of study was short, these values are not estimates of usual intake. The recommended values for soil ingestion among children and adults are summarized in Table 4-23.

Data on soil ingestion rates for children who deliberately ingest soil are also limited. An ingestion rate of 10 g/day is a reasonable value for use in acute exposure assessments, based on the available information. It should be noted, however, that this value is based on only one pica child observed in the Calabrese et al. (1989) study.

*Soil Ingestion Among Adults* - Only three studies have attempted to estimate adult soil ingestion. Hawley (1985) suggested a value of 480 mg/day for adults engaged in outdoor activities and a range of 0.56 to 110 mg/day of house dust during indoor activities. These estimates were



---

*Chapter 4 - Soil Ingestion and Pica*

---

derived from assumptions about soil/dust levels on hands and mouthing behavior; no supporting measurements were made. Making further assumptions about frequencies of indoor and outdoor activities, Hawley (1985) derived an annual average of 60.5 mg/day. Given the lack of supporting measurements, these estimates must be considered conjectural. Krablin (1989) used arsenic levels in urine (n=26) combined with information on mouthing behavior and activity patterns to suggest an estimate for adult soil ingestion of 10 mg/day. The study protocols are not well described and has not been formally published. Finally, Calabrese et al. (1990) conducted a tracer study on 6 adults and found a range of 30 to 100 mg/day. This study is probably the most reliable of the three, but still has two significant uncertainties: (1)

representativeness of the general population is unknown due to the small study size (n=6); and (2) representativeness of long-term behavior is unknown since the study was conducted over only 2 weeks. In the past, many EPA risk assessments have assumed an adult soil ingestion rate of 50 mg/day for industrial settings and 100 mg/day for residential and agricultural scenarios. These values are within the range of estimates from the studies discussed above. Thus, 50 mg/day still represents a reasonable central estimate of adult soil ingestion and is the recommended value in this handbook. This recommendation is clearly highly uncertain; however, and as indicated in Table 4-21, is given a low confidence rating. Considering the uncertainties in the central estimate, a recommendation for an upper percentile value would be inappropriate. Table 4-23 summarizes soil ingestion recommendations for adults.



Table 4-20. Soil Intake Studies

Study	Study Type	Number of Observations	Age	Population Studied	Comments
<b><u>CHILDREN KEY STUDIES:</u></b>					
Binder et al., 1986	Tracer study using aluminum, silicon, and titanium	59 children	1-3 years	Children living near lead smelter in Montana	Did not account for tracer in food and medicine; used assumed fecal weight of 15 g/day; short-term study conducted over 3 days
Calabrese et al., 1989	Tracer - mass balance study using aluminum, barium, manganese, silicon, titanium, vanadium, yttrium, and zirconium	64 Children	1-4 years	Children from greater Amherst area of Massachusetts; highly-educated parents	Corrected for tracer in food and medicine; study conducted over two-week period; used adults to validate methods; one pica child in study group.
Clausing et al., 1987	Tracer study using aluminum, acid insoluble residue, and titanium	18 nursery school children; 6 hospitalized children	2-4 years	Dutch children	Did not account for tracer in food and medicines; used tracer-based intake rates for hospitalized children as background values; short-term study conducted over 5 days
Davis et al., 1990	Tracer - mass balance study using aluminum silicon and titanium	104 children	2-7 years	Children from 3-city area in Washington State	Corrected for tracer in food and medicine; short-term study conducted over seven-day period; collected information on demographic characteristics affecting soil intake.
Stanek and Calabrese, 1995a	Adjusted soil intake estimates	64 children	1-4 years	Same children as in Calabrese et al., 1989	Based on data from Calabrese et al., 1989
Stanek and Calabrese, 1995b	Recalculated intake rates based on three previous mass-balance studies using the Best Tracer Method	164 children 6 adults	1-7 years 25-41 years	Children from three mass-balance studies	Based on studies of Calabrese et al., 1989; Davis et al., 1990; and Calabrese et al., 1990.
Van Wijnen et al., 1990	Tracer study using aluminum, acid insoluble residue, and titanium	292 daycare children; 78 campers; 15 hospitalized children	1-5 years	Dutch children	Did not account for tracer in food and medicines; used tracer-based intake for hospitalized children as background values; evaluated population (campers) with greater access to soil; evaluated differences in soil intake due to weather conditions.
<b><u>CHILDREN RELEVANT STUDIES</u></b>					
AIHC, 1994	Reanalysis of data from Calabrese et al., 1990	6 adults	21-41 years	Health adults	Used data from Calabrese et al. (1990) study to derive soil ingestion rates using zirconium as a tracer; recent studies indicate that zirconium is not a good tracer
Calabrese and Stanek, 1995	Evaluated errors in soil ingestion estimates	64 children	1-4 years	Study population of Calabrese et al., 1989	Based on Calabrese et al., 1989 data.



Table 4-20. Soil Intake Studies (continued)

Study	Study Type	Number of Observations	Age	Population Studied	Comments
<b><u>CHILDREN RELEVANT STUDIES(continued):</u></b>					
Day et al., 1977	Measured dirt on sticky sweets and assumed number of sweets eaten per day	Not specified	Not specified	Not specified	Based on observations and crude measurements.
Duggan and Williams, 1977	Measured soil on fingers and observed mouthing behavior	Not specified	Not specified	Areas around London	Based on observations and crude measurements.
Hawley, 1985	Assumed soil intake rates based on nature and duration of activities	Not specified	Young children, older children, adults	Not specified	No data on soil intake collected; estimates based on assumptions regarding data from previous studies.
Lepow et al., 1974; 1975	Measured soil on hands and observed mouthing behavior	22 children	2-6 years	Urban children from Connecticut	Based on observations over 3-6 hours of play and crude measurement techniques.
Sedman and Mahmood, 1994	Adjusted data from earlier tracer-mass balance studies to generate mean soil intake rates for a 2-year old child	64 children from Calabrese et al., 1989 study and 104 children from Davis et al., 1990 study	Adjusted to 2-year old child	Same children as in Calabrese et al., 1989 and Davis et al., 1990 study	Based on data from Calabrese et al., 1989 and Davis et al., 1990.
Sheppard, 1995	Provides estimates based on the current literature on soil ingestion from tracer methods and recommends values for use in assessments	Not specified	1 year-adults (age not specified)	Various	Presents mean estimates for children and adults; provides ingestion estimates for indoor and outdoor activities based on Hawley, 1985.
Thompson and Burmaster, 1991	Re-evaluation of Binder et al., 1986 data	59 children	1-3 years	Children living near lead smelter in Montana	Re-calculated soil intake rates from Binder et al., 1986 data using actual fecal weights instead of assumed weights.
<b><u>ADULT SOIL INTAKE STUDIES</u></b>					
Hawley, 1985	Assumed soil intake rates based on nature and duration of activities	Not specified	Young children, older children, adults	Not specified	No data on soil intake collected; estimates based on assumptions regarding data from previous studies.
Calabrese et al., 1990	Measured excretory output after ingestion of capsules with sterilized soil	6 adults	21-41 years	Healthy adult volunteers	Data used to validate the analytical methodology used in the children's study (Calabrese, 1989).
<b><u>PICA STUDIES:</u></b>					
Calabrese et al., 1991	Tracer - mass balance	1 pica child	3.5 years	1 pica child from greater Amherst area of Massachusetts	Child was observed as part of the Calabrese et al., 1989 study.
Calabrese and Stanek, 1992	Reanalysis of data from Calabrese et al., 1991	1 pica child	3.5 years	1 pica child from greater Amherst area of Massachusetts	Distinguished between outdoor soil ingestion and indoor dust ingestion in a soil pica child.



Table 4-21. Confidence in Soil Intake Recommendation		
Considerations	Rationale	Rating
<b>Study Elements</b>		
<ul style="list-style-type: none"> <li>Level of peer review</li> </ul>	All key studies are from peer review literature.	High
<ul style="list-style-type: none"> <li>Accessibility</li> </ul>	Papers are widely available from peer review journals.	High
<ul style="list-style-type: none"> <li>Reproducibility</li> </ul>	Methodology used was presented, but results are difficult to reproduce.	Medium
<ul style="list-style-type: none"> <li>Focus on factor of interest</li> </ul>	The focus of the studies was on estimating soil intake rate by children; studies did not focus on intake rate by adults.	High (for children) Low (for adults)
<ul style="list-style-type: none"> <li>Data pertinent to U.S.</li> </ul>	Two of the key studies focused on Dutch children; other studies used children from specific areas of the U.S.	Medium
<ul style="list-style-type: none"> <li>Primary data</li> </ul>	All the studies were based on primary data.	High
<ul style="list-style-type: none"> <li>Currency</li> </ul>	Studies were conducted after 1980.	High
<ul style="list-style-type: none"> <li>Adequacy of data collection period</li> </ul>	Children were not studied long enough to fully characterize day to day variability.	Medium
<ul style="list-style-type: none"> <li>Validity of approach</li> </ul>	The basic approach is the only practical way to study soil intake, but refinements are needed in tracer selection and matching input with outputs. The more recent studies corrected the data for sources of the tracers in food. There are, however, some concerns about absorption of the tracers into the body and lag time between input and output.	Medium
<ul style="list-style-type: none"> <li>Study size</li> </ul>	The sample sizes used in the key studies were adequate for children. However, only few adults have been studied.	Medium (for children) Low (for adults)
<ul style="list-style-type: none"> <li>Representativeness of the population</li> </ul>	The study population may not be representative of the U.S. in terms of race, socio-economics, and geographical location; Studies focused on specific areas; two of the studies used Dutch children.	Low
<ul style="list-style-type: none"> <li>Characterization of variability</li> </ul>	Day-to-day variability was not very well characterized.	Low
<ul style="list-style-type: none"> <li>Lack of bias in study design (high rating is desirable)</li> </ul>	The selection of the population studied may introduce some bias in the results (i.e., children near a smelter site, volunteers in nursery school, Dutch children).	Medium
<ul style="list-style-type: none"> <li>Measurement error</li> </ul>	Errors may result due to problems with absorption of the tracers in the body and mismatching inputs and outputs.	Medium
<b>Other Elements</b>		
<ul style="list-style-type: none"> <li>Number of studies</li> </ul>	There are 7 key studies.	High
<ul style="list-style-type: none"> <li>Agreement between researchers</li> </ul>	Despite the variability, there is general agreement among researchers on central estimates of daily intake for children.	Medium
<b>Overall Rating</b>	Studies were well designed; results were fairly consistent; sample size was adequate for children and very small for adults; accuracy of methodology is uncertain; variability cannot be characterized due to limitations in data collection period. Insufficient data to recommend upper percentile estimates for both children and adults.	Medium (for children - long-term central estimate) Low (for adults) Low (for upper percentile)





Table 4-22. Summary of Estimates of Soil Ingestion by Children									
Mean (mg/day)					Upper Percentile (mg/day)				References
Al	Si	AIR <sup>a</sup>	Ti	Y	Al	Si	Ti	Y	
181	184				584	578			Binder et al. 1986
230		129							Clausing et al. 1987
39	82		245.5						Davis et al. 1990
64.5 <sup>b</sup>	160 <sup>b</sup>		268.4 <sup>b</sup>						
153	154		218	85	223	276	1,432	106	Calabrese et al. 1989
154 <sup>b</sup>	483 <sup>b</sup>		170 <sup>b</sup>	65 <sup>b</sup>	478 <sup>b</sup>	653 <sup>b</sup>	1,059 <sup>b</sup>	159 <sup>b</sup>	
122	139	--	271	165	254	224	279	144	Stanek and Calabrese, 1995a
133 <sup>c</sup>					217 <sup>c</sup>				Stanek and Calabrese, 1995b
69-120 <sup>d</sup>									Van Wijnen et al. 1990
Average	=	146 mg/day soil			383 mg/day soil				
		191 mg/day soil and dust combined			587 mg/day soil and dust combined				
<sup>a</sup>	AIR = Acid Insoluble Residue								
<sup>b</sup>	Soil and dust combined								
<sup>c</sup>	BTM								
<sup>d</sup>	LTM; corrected value								

Population	Mean	Upper Percentile
Children	100 mg/day <sup>a</sup>	400 mg/day <sup>b</sup>
Adults	50 mg/day	--
Pica child	10 g/day <sup>c</sup>	---
<sup>a</sup>	200 mg/day may be used as a conservative estimate of the mean (see text).	
<sup>b</sup>	Study period was short; therefore, these values are not estimates of usual intake.	
<sup>c</sup>	To be used in acute exposure assessments. Based on only one pica child (Calabrese et al., 1989).	

4.8. REFERENCES FOR CHAPTER 4

American Industrial Health Council (AIHC). (1994) Exposure factors sourcebook. AIHC, Washington, DC.

Binder, S.; Sokal, D.; Maughan, D. (1986) Estimating soil ingestion: the use of tracer elements in estimating the amount of soil ingested by young children. Arch. Environ. Health. 41(6):341-345.

Behrman, L.E.; Vaughan, V.C., III. (1983) Textbook of Pediatrics. Philadelphia, PA: W.B. Saunders Company.

Bruhn, C.M.; Pangborn, R.M. (1971) Reported incidence of pica among migrant families. J. of the Am. Diet. Assoc. 58:417-420.

Calabrese, E.J.; Kostecki, P.T.; Gilbert, C.E. (1987) How much soil do children eat? An emerging consideration for environmental health risk assessment. In press (Comments in Toxicology).

Calabrese, E.J.; Pastides, H.; Barnes, R.; Edwards, C.; Kostecki, P.T.; et al. (1989) How much soil do young children ingest: an epidemiologic study. In: Petroleum Contaminated Soils, Lewis Publishers, Chelsea, MI. pp. 363-397.

Calabrese, E.J.; Stanek, E.J.; Gilbert, C.E.; Barnes, R.M. (1990) Preliminary adult soil ingestion estimates; results of a pilot study. Regul. Toxicol. Pharmacol. 12:88-95.

Calabrese, E.J.; Stanek, E.J.; Gilbert, C.E. (1991) Evidence of soil-pica behavior and quantification of soil ingested. Hum. Exp. Toxicol. 10:245-249.



- Calabrese, E.J.; Stanek, E.J. (1992) Distinguishing outdoor soil ingestion from indoor dust ingestion in a soil pica child. *Regul. Toxicol. Pharmacol.* 15:83-85.
- Calabrese, E.J.; Stanek, E.J. (1995) Resolving intertracer inconsistencies in soil ingestion estimation. *Environ. Health Perspect.* 103(5):454-456.
- Clausing, P.; Brunekreef, B.; Van Wijnen, J.H. (1987) A method for estimating soil ingestion by children. *Int. Arch. Occup. Environ. Health (W. Germany)* 59(1):73-82.
- Danford, D.C. (1982) Pica and nutrition. *Annual Review of Nutrition.* 2:303-322.
- Davis, S.; Waller, P.; Buschbon, R.; Ballou, J.; White, P. (1990) Quantitative estimates of soil ingestion in normal children between the ages of 2 and 7 years: population based estimates using aluminum, silicon, and titanium as soil tracer elements. *Arch. Environ. Hlth.* 45:112-122.
- Day, J.P.; Hart, M.; Robinson, M.S. (1975) Lead in urban street dust. *Nature* 253:343-345.
- Duggan, M.J.; Williams, S. (1977) Lead in dust in city streets. *Sci. Total Environ.* 7:91-97.
- Feldman, M.D. (1986) Pica: current perspectives. *Psychosomatics (USA)* 27(7):519-523.
- Forfar, J.O.; Arneil, G.C., eds. (1984) *Textbook of Paediatrics.* 3rd ed. London: Churchill Livingstone.
- Hawley, J.K. (1985) Assessment of health risk from exposure to contaminated soil. *Risk Anal.* 5:289-302.
- Illingworth, R.S. (1983) *The normal child.* New York: Churchill Livingstone.
- Kaplan, H.I.; Sadock, B.J. (1985) *Comprehensive textbook of psychiatry/IV.* Baltimore, MD: Williams and Wilkins.
- Kimbrough, R.; Falk, H.; Stemr, P.; Fries, G. (1984) Health implications of 2,3,7,8-tetrachlorodibenzo-p-dioxin (TCDD) contamination of residential soil. *J. Toxicol. Environ. Health* 14:47-93.
- Krablin, R. (1989) [Letter to Jonathan Z. Cannon concerning soil ingestion rates.] Denver, CO: Arco Coal Co.; October 13, 1989.
- Lepow, M.L.; Bruckman, L.; Robino, R.A.; Markowitz, S.; Gillette, M.; et al. (1974) Role of airborne lead in increased body burden of lead in Hartford children. *Environ. Health Perspect.* 6:99-101.
- Lepow, M.L.; Buckman, L.; Gillette, M.; Markowitz, S.; Robino, R.; et al. (1975) Investigations into sources of lead in the environment of urban children. *Environ. Res.* 10:415-426.
- Lourie, R.S.; Layman, E.M.; Millican, F.K. (1963) Why children eat things that are not food. *Children* 10:143-146.
- Roels, H.; Buchet, J.P.; Lauwerys, R.R. (1980) Exposure to lead by the oral and pulmonary route of children living in the vicinity of a primary lead smelter. *Environ. Res.* 22:81-94.
- Sayetta, R.B. (1986) Pica: An overview. *American Family Physician* 33(5):181-185.
- Sedman, R.; Mahmood, R.S. (1994) Soil ingestion by children and adults reconsidered using the results of recent tracer studies. *Air and Waste*, 44:141-144.
- Sheppard, S.C. (1995) Parameter values to model the soil ingestion pathway. *Environmental Monitoring and Assessment* 34:27-44.
- Stanek, E.J.; Calabrese, E.J. (1995a) Daily estimates of soil ingestion in children. *Environ. Health Perspect.* 103(3):276-285.
- Stanek, E.J.; Calabrese, E.J. (1995b) Soil ingestion estimates for use in site evaluations based on the best tracer method. *Human and Ecological Risk Assessment.* 1:133-156.
- Thompson, K.M.; Burmaster, D.E. (1991) Parametric distributions for soil ingestion by children. *Risk Analysis.* 11:339-342.
- U.S. EPA. (1984) *Risk analysis of TCDD contaminated soil.* Washington, DC: U.S. Environmental Protection Agency, Office of Health and Environmental Assessment. EPA 600/8-84-031.
- Van Wijnen, J.H.; Clausing, P.; Brunekreef, B. (1990) Estimated soil ingestion by children. *Environ. Res.* 51:147-162.
- Vermeer, D.E.; Frate, D.A. (1979) Geophagia in rural Mississippi: environmental and cultural contexts and nutritional implications. *Am. J. Clin. Nutr.* 32:2129-2135.

## TABLE OF CONTENTS

	<u>Page No.</u>
5. INHALATION ROUTE .....	1
5.1. EXPOSURE EQUATION FOR INHALATION .....	1
5.2. INHALATION RATE .....	1
5.2.1. Background .....	1
5.2.2. Key Inhalation Rate Studies .....	3
5.2.3. Relevant Inhalation Rate Studies .....	16
5.2.4. Recommendations .....	22
5.3. REFERENCES FOR CHAPTER 5 .....	27



## 5. INHALATION ROUTE

This chapter presents data and recommendations for inhalation rates that can be used to assess exposure to contaminants in air. The studies discussed in this chapter have been classified as key or relevant. Key studies are used as the basis for deriving recommendations and the relevant studies are included to provide additional background and perspective. The recommended inhalation rates are summarized in Section 5.2.4 and cover adults, children, and outdoor workers/athletes.

Inclusion of this chapter in the Exposure Factors Handbook does not imply that assessors will always need to select and use inhalation rates when evaluating exposure to air contaminants. In fact, it is unnecessary to calculate inhaled dose when using dose-response factors from Integrated Risk Information System (IRIS) (U.S. EPA, 1994). This is due to the fact that IRIS methodology accounts for inhalation rates in the development of “dose-response” relationships. When using IRIS for inhalation risk assessments, “dose-response” relationships require only an average air concentration to evaluate health concerns:

- For non-carcinogens, IRIS uses Reference Concentrations (RfC) which are expressed in concentration units. Hazard is evaluated by comparing the inspired air concentration to the RfC.
- For carcinogens, IRIS uses unit risk values which are expressed in inverse concentration units. Risk is evaluated by multiplying the unit risk by the inspired air concentration.

Detailed descriptions of the IRIS methodology for derivation of inhalation reference concentrations can be found in two methods manuals produced by the Agency (U.S. EPA, 1992; 1994).

IRIS employs a default inhalation rate of 20 m<sup>3</sup>/day. This is greater than the recommended value in this chapter. When using IRIS, adjustments of dose-response relationships using inhalation rates other than the default, 20 m<sup>3</sup>/day, are not currently recommended. There are instances where the inhalation rate data presented in this chapter may be used for estimating average daily dose. For example, the inhalation average daily dose is often estimated in cases where a comparative pathway analysis is desired or to determine a total dose by adding across

pathways in cases where RfCs and unit risk factors are not available.

### 5.1. EXPOSURE EQUATION FOR INHALATION

For those cases where the average daily dose (ADD) needs to be estimated, the general equation is:

$$ADD = [(C \times IR \times ED) / (BW \times AT)] \quad (\text{Eqn. 5-1})$$

where:

- ADD = average daily dose (mg/kg-day);
- C = contaminant concentration in inhaled air ( $\mu\text{g}/\text{m}^3$ );
- IR = inhalation rate ( $\text{m}^3/\text{day}$ );
- ED = exposure duration (days);
- BW = body weight (kg); and
- AT = averaging time (days), for non-carcinogenic effects AT = ED, for carcinogenic or chronic effects AT = 70 years or 25,550 days (lifetime).

The average daily dose is the dose rate averaged over a pathway-specific period of exposure expressed as a daily dose on a per-unit-body-weight basis. The ADD is used for exposure to chemicals with non-carcinogenic non-chronic effects. For compounds with carcinogenic or chronic effects, the lifetime average daily dose (LADD) is used. The LADD is the dose rate averaged over a lifetime. The contaminant concentration refers to the concentration of the contaminant in inhaled air. Exposure duration refers to the total time an individual is exposed to an air pollutant.

### 5.2. INHALATION RATE

#### 5.2.1. Background

The Agency defines exposure as the chemical concentration at the boundary of the body (U.S. EPA, 1992). In the case of inhalation, the situation is complicated by the fact that oxygen exchange with carbon dioxide takes place in the distal portion of the lung. The anatomy and physiology of the respiratory system diminishes the pollutant concentration in inspired air (potential dose) such that the amount of a pollutant that actually enters the body through the lung (internal dose) is less than that measured at the boundary of the body (Figure 5-1). When constructing risk assessments that concern the inhalation route of exposure, one must be aware if any adjustments have been employed in the estimation of the pollutant concentration to account for this reduction in potential dose.

The respiratory system is comprised of three regions: nasopharyngeal, tracheobronchial, and pulmonary. The

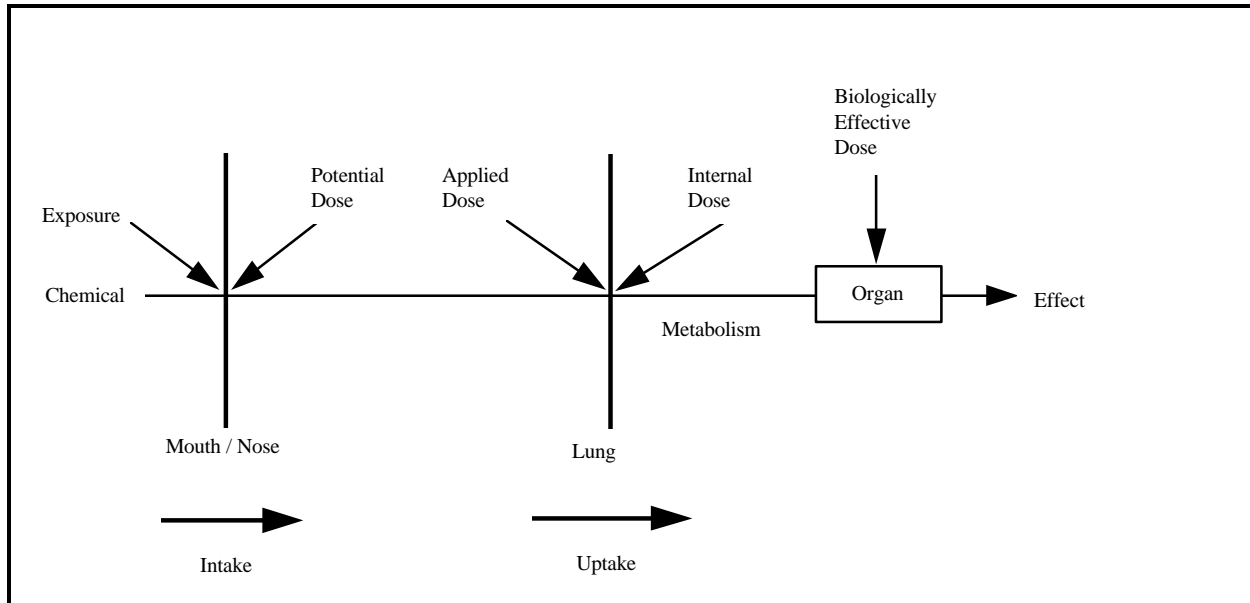

Figure 5-1. Schematic of Dose and Exposure: Respiratory Route

Source: U.S. EPA, 1992.

nasopharyngeal region extends from the nose to the larynx. The tracheobronchial region forms the conducting airways between nasopharynx and alveoli where gas exchange occurs. It consists of the trachea, bronchi, and bronchioles. The pulmonary regions consists of the acinus which is the site where gas exchange occurs; it is comprised of respiratory bronchioles, alveolar ducts and sacs, and alveoli. A detailed discussion of pulmonary anatomy and physiology can be found in: Benjamin (1988) and U.S. EPA (1989 and 1994).

Each region in the respiratory system can be involved with removing pollutants from inspired air. The nasopharyngeal region filters out large inhaled particles, moderates the temperature, and increases the humidity of the air. The surface of the tracheobronchial region is covered with ciliated mucous secreting cells which forms a mucociliary escalator that moves particles from deep regions of the lung to the oral cavity where they may be swallowed and then excreted. The branching pattern and physical dimensions of these airways determine the pattern of deposition of airborne particles and absorption of gases by the respiratory tract. They decrease in diameter as they divide into a bifurcated branching network dilutes gases by axial diffusion of gases along the streamline of airways and radial diffusion of gases due to an increase in

cross sectional area of the lungs. The velocity of the airstream in this decreasing branching network creates a turbulent force such that airborne particles can be deposited along the walls of these airways by impaction, interception, sedimentation, or diffusion depending on their size. The pulmonary region contains macrophages which engulf particles and pathogens that enter this portion of the lung.

Notwithstanding these removal mechanisms, both gaseous and particulate pollutants can deposit in various regions of the lung. Both the physiology of the lung and the chemistry of the pollutant influences where the pollutant tends to deposit.

Gaseous pollutants are evenly dispersed in the air stream. They come into contact with a large portion of the lung. Generally, their solubility and reactivity determines where they deposit in the lung. Water soluble and chemically reactive gases tend to deposit in the upper respiratory tract. Lipid soluble or non-reactive gases usually are not removed in the upper airways and tend to deposit in the distal portions of the lung. Gases can be absorbed into the blood stream or react with lung tissue. Gases can be removed from the lung by reaction with tissues or by expiration. The amount of gas retained in the lung or other parts of the body is mainly due to their solubility in blood.



Chemically, particles are quite heterogenous. They range from aqueous soluble particles to solid insoluble particles. Their size, chemical composition, and the physical forces of breathing dictate where they tend to deposit in the lung. Large particles, those with a diameter of greater than 0.5 micrometers ( $\mu\text{m}$ ), not filtered out in the nasopharynx, tend to deposit in the upper respiratory tract at airway branching points due to impaction. The momentum of these particles in the air stream is such that they tend to collide with the airway wall at branching points in the tracheobronchial region of the lung. Those particles not removed from the airstream by impaction will likely be deposited in small bronchi and bronchioles by sedimentation, a process where by particles settle out of the airstream due to the decrease in airstream velocity and the gravitational force on the particles. Small particles, less than 0.2  $\mu\text{m}$ , acquire a random motion due to bombardment by air molecules. This movement can cause particles to be deposited on the wall of an air way throughout the lungs.

A special case exists for fibers. Fibers can deposit along the wall of an airway by a process known as interception. This occurs when a fiber makes contact with an airway wall. The likelihood of interception increases as airway diminish in diameter. Fiber shape influences deposition too. Long, thin, straight fibers tend to deposit in the deep region of the lung compared to thick or curved fibers.

The health risk associated with human exposure to airborne toxics is a function of concentration of air pollutants, chemical species, duration of exposure, and inhalation rate. The dose delivered to target organs (including the lungs), the biologically effective dose, is dependent on the potential dose, the applied dose and the internal dose (Figure 5-1) A detailed discussion of this concept can be found in Guidelines for Exposure Assessment (U.S. EPA, 1992).

The estimation of applied dose for a given air pollutant is dependent on inhalation rate, commonly described as ventilation rate (VR) or breathing rate. VR is usually measured as minute volume, the volume in liters of air exhaled per minute ( $V_E$ ).  $\dot{V}_E$  is the product of the number of respiratory cycles in a minute and the volume of air respired during each respiratory cycle, the tidal volume ( $V_T$ ).

When interested in calculating internal dose, assessors must consider the alveolar ventilation rate. This is the amount of air available for exchange with alveoli per unit time. It is equivalent to the tidal volume ( $V_T$ ) minus the anatomic dead space of the lungs (the space containing air

that does not come into contact with the alveoli). Alveolar ventilation is approximately 70 percent of total ventilation; tidal volume is approximately 500 milliliters (ml) and the amount of anatomic dead space in the lungs is approximately 150 ml, approximately 30% of the amount of air inhaled (Menzel and Amdur, 1986).

Breathing rates are affected by numerous individual characteristics, including age, gender, weight, health status, and levels of activity (running, walking, jogging, etc.). VRs are either measured directly using a spirometer and a collection system or indirectly from heart rate (HR) measurements. In many of the studies described in the following sections, HR measurements are usually correlated with VR in simple and multiple regression analysis.

The available studies on inhalation rates are summarized in the following sections. Inhalation rates are reported for adults and children (including infants) performing various activities and outdoor workers/athletes. The activity levels have been categorized as resting, sedentary, light, moderate, and heavy. In most studies, the sample population kept diaries to record their physical activities, locations, and breathing rates. Ventilation rates were either measured, self-estimated or predicted from equations derived using VR-HR calibration relationships.

### 5.2.2. Key Inhalation Rate Studies

*Linn et al. (1992) - Documentation of Activity Patterns in "High-Risk" Groups Exposed to Ozone in the Los Angeles Area* - Linn et al. (1992) conducted a study that estimated the inhalation rates for "high-risk" subpopulation groups exposed to ozone ( $\text{O}_3$ ) in their daily activities in the Los Angeles area. The population surveyed consisted of seven subject panels: *Panel 1*: 20 healthy outdoor workers (15 males, 5 females, ages 19-50 years); *Panel 2*: 17 healthy elementary school students (5 males, 12 females, ages 10-12 years); *Panel 3*: 19 healthy high school students (7 males, 12 females, ages 13-17 years); *Panel 4*: 49 asthmatic adults (clinically mild, moderate, and severe, 15 males, 34 females, ages 18-50 years); *Panel 5*: 24 asthmatic adults from 2 neighborhoods of contrasting  $\text{O}_3$  air quality (10 males, 14 females, ages 19-46 years); *Panel 6*: 13 young asthmatics (7 males, 6 females, ages 11-16 years); *Panel 7*: construction workers (7 males, ages 26-34 years).

Initially, a calibration test was conducted, followed by a training session. Finally, a field study was conducted which involved subjects' collecting their own heart rate and diary data. During the calibration tests, VR and HR were measured simultaneously at each exercise level. From the calibration data an equation was developed using linear



regression analysis to predict VR from measured HR (Linn et al., 1992).

In the field study, each subject (except construction workers) recorded in diaries: their daily activities, change in locations (indoors, outdoors, or in a vehicle), self-estimated breathing rates during each activity/location, and time spent at each activity/location. Healthy subjects recorded their HR once every 60 seconds, Asthmatic subjects recorded their diary information once every hour using a Heart Watch. Construction workers dictated their diary information to a technician accompanying them on the job. Subjective breathing rates were defined as slow (walking at their normal pace); medium (faster than normal walking); and fast (running or similarly strenuous

exercise). Table 5-1 presents the calibration and field protocols for self-monitoring of activities for each subject panel.

Table 5-2 presents the mean VR, the 99th percentile VR, and the mean VR at each subjective activity level (slow, medium, fast). The mean VR and 99th percentile VR were derived from all HR recordings (that appeared to be valid) without considering the diary data. Each of the three activity levels was determined from both the concurrent diary data and HR recordings by direct calculation or regression (Linn et al., 1992). The mean VR for healthy adults was 0.78 m<sup>3</sup>/hr while the mean VR for asthmatic adults was 1.02 m<sup>3</sup>/hr (Table 5-2). The preliminary data for construction workers indicated that during a 10-hr work shift, their mean VR (1.50 m<sup>3</sup>/hr) exceeded the VRs of all other subject panels (Table 5-2). Linn et al. (1992) reported that the diary data showed that most individuals except construction workers spent most of their time (in a typical day) indoors at slow activity level. During slow activity, asthmatic subjects had higher VRs than healthy subjects, except construction workers (Table 5-2). Also, Linn et al. (1992) reported that in every panel, the predicted VR correlated significantly with the subjective estimates of activity levels.

Table 5-1. Calibration and Field Protocols for Self-Monitoring of Activities Grouped by Subject Panels

Panel	Calibration Protocol	Field Protocol
Panel 1 - Healthy Outdoor Workers - 15 female, 5 male, age 19-50	Laboratory treadmill exercise tests, indoor hallway walking tests at different self-chosen speeds, 2 outdoor tests consisted of 1-hour cycles each of rest, walking, and jogging.	3 days in 1 typical summer week (included most active workday and most active day off); HR recordings and activity diary during waking hours.
Panel 2 - Healthy Elementary School Students - 5 male, 12 female, age 10-12	Outdoor exercises each consisted of 20 minute rest, slow walking, jogging and fast walking	Saturday, Sunday and Monday (school day) in early autumn; HR recordings and activity diary during waking hours and during sleep.
Panel 3 - Healthy High School Students - 7 male, 12 female, age 13-17	Outdoor exercises each consisted of 20 minute rest, slow walking, jogging and fast walking	Same as Panel 2, however, no HR recordings during sleep for most subjects.
Panel 4 - Adult Asthmatics, clinically mild, moderate, and severe - 15 male, 34 female, age 18-50	Treadmill and hallway exercise tests	1 typical summer week, 1 typical winter week; hourly activity/health diary during waking hours; lung function tests 3 times daily; HR recordings during waking hours on at least 3 days (including most active work day and day off).
Panel 5 - Adult Asthmatics from 2 neighborhoods of contrasting O <sub>3</sub> air quality - 10 male, 14 female, age 19-46	Treadmill and hallway exercise tests	Similar to Panel 4, personal NO <sub>2</sub> and acid exposure monitoring included. (Panels 4 and 5 were studied in different years, and had 10 subjects in common).
Panel 6 - Young Asthmatics - 7 male, 6 female, age 11-16	Laboratory exercise tests on bicycles and treadmills	Similar to Panel 4, summer monitoring for 2 successive weeks, including 2 controlled exposure studies with few or no observable respiratory effects.
Panel 7 - Construction Workers - 7 male, age 26-34	Performed similar exercises as Panel 2 and 3, and also performed job-related tests including lifting and carrying a 9-kg pipe.	HR recordings and diary information during 1 typical summer work day.

Source: Linn et al., 1992



Table 5-2. Subject Panel Inhalation Rates by Mean VR, Upper Percentiles, and Self-Estimated Breathing Rates

Panel	Inhalation Rates (m <sup>3</sup> /hr)					
	N <sup>a</sup>	Mean VR (m <sup>3</sup> /hr)	99th Percentile VR	Mean VR at Activity Levels (m <sup>3</sup> /hr) <sup>b</sup>		
				Slow	Medium <sup>c</sup>	Fast <sup>c</sup>
<u>Healthy</u>						
1 - Adults	20	0.78	2.46	0.72	1.02	3.06
2 - Elementary School Students	17	0.90	1.98	0.84	0.96	1.14
3 - High School Students	19	0.84	2.22	0.78	1.14	1.62
7 - Construction Workers <sup>c</sup>	7	1.50	4.26	1.26	1.50	1.68
<u>Asthmatics</u>						
4 - Adults	49	1.02	1.92	1.02	1.68	2.46
5 - Adults <sup>d</sup>	24	1.20	2.40	1.20	2.04	4.02
6 - Elementary and High School Students	13	1.20	2.40	1.20	1.20	1.50
<sup>a</sup>	Number of individuals in each survey panel.					
<sup>b</sup>	Some subjects did not report medium and/or fast activity. Group means were calculated from individual means (i.e., give equal weight to each individual who recorded any time at the indicated activity level).					
<sup>c</sup>	Construction workers recorded only on 1 day, mostly during work, while others recorded on ≥ 1 work or school day and ≥ 1 day off.					
<sup>d</sup>	Excluding subjects also in Panel 4.					
Source: Linn et al., 1992.						

A limitation of this study is that calibration data may overestimate the predictive power of HR during actual field monitoring. The wide variety of exercises in everyday activities may result in greater variation of the VR-HR relationship than calibrated. Another limitation of this study is the small sample size of each subpopulation surveyed. An advantage of this study is that diary data can provide rough estimates of ventilation patterns which are useful in exposure assessments. Another advantage is that inhalation rates were presented for various subpopulations (i.e., healthy outdoor adult workers, healthy children, asthmatics, and construction workers).

*Spier et al. (1992) - Activity Patterns in Elementary and High School Students Exposed To Oxidant Pollution -*

Spier et al. (1992) investigated activity patterns of 17 elementary school students (10-12 years old) and 19 high school students (13-17 years old) in suburban Los Angeles from late September to October (oxidant pollution season). Calibration tests were conducted in supervised outdoor exercise sessions. The exercise sessions consisted of 5 minutes for each: rest, slow walking, jogging, and fast walking. HR and VR were measured during the last 2 minutes of each exercise. Individual VR and HR relationships for each individual were determined by fitting a regression line to HR values and log VR values. Each subject recorded their daily activities, change in location, and breathing rates in diaries for 3 consecutive days. Self-estimated breathing rates were recorded as slow (slow walking), medium (walking faster than normal), and fast (running). HR was recorded during

the 3 days once per minute by wearing a Heart Watch. VR values for each self-estimated breathing rate and activity type were estimated from the HR recordings by employing the VR and HR equation obtained from the calibration tests.

The data presented in Table 5-3 represent HR distribution patterns and corresponding predicted VR for each age group during hours spent awake. At the same self-reported activity levels for both age groups, inhalation rates were higher for outdoor activities than for indoor activities. The total hours spent indoors by high school students (21.2 hours) were higher than for elementary school students (19.6 hours). The converse was true for outdoor activities; 2.7 hours for high school students, and 4.4 hours for elementary school students (Table 5-4). Based on the data presented in Tables 5-3 and 5-4, the average activity-specific inhalation rates for elementary (10-12 years) and high school (13-17 years) students were calculated in Table 5-5. For elementary school students, the average daily inhalation rates (based on indoor and outdoor locations) are 15.8 m<sup>3</sup>/day for light activities, 4.62 m<sup>3</sup>/day for moderate activities, and 0.98 m<sup>3</sup>/day for heavy activities. For high school students the daily inhalation rates for light, moderate, and heavy activities are estimated to be 16.4 m<sup>3</sup>/day, 3.1 m<sup>3</sup>/day, and 0.54 m<sup>3</sup>/day, respectively (Table 5-5).





Table 5-3. Distribution of Predicted IR by Location and Activity Levels for Elementary and High School Students

Age (yrs)	Student	Location	Activity Level	% Recorded Time <sup>a</sup>	Inhalation Rates (m <sup>3</sup> /hr)			
					Percentile Rankings <sup>b</sup>			
					Mean ± SD	1st	50th	99.9th
10-12	EL <sup>c</sup> (n <sup>d</sup> =17)	Indoors	slow	49.6	0.84 ± 0.36	0.18	0.78	2.34
			medium	23.6	0.96 ± 0.42	0.24	0.84	2.58
			fast	2.4	1.02 ± 0.60	0.24	0.84	3.42
		Outdoors	slow	8.9	0.96 ± 0.54	0.36	0.78	4.32
			medium	11.2	1.08 ± 0.48	0.24	0.96	3.36
			fast	4.3	1.14 ± 0.60	0.48	0.96	3.60
13-17	HS <sup>c</sup> (n <sup>d</sup> =19)	Indoors	slow	70.7	0.78 ± 0.36	0.30	0.72	3.24
			medium	10.9	0.96 ± 0.42	0.42	0.84	4.02
			fast	1.4	1.26 ± 0.66	0.54	1.08	6.84 <sup>e</sup>
		Outdoors	slow	8.2	0.96 ± 0.48	0.42	0.90	5.28
			medium	7.4	1.26 ± 0.78	0.48	1.08	5.70
			fast	1.4	1.44 ± 1.08	0.48	1.02	5.94

<sup>a</sup> Recorded time averaged about 23 hr per elementary school student and 33 hr. per high school student, over 72-hr. periods.  
<sup>b</sup> Geometric means closely approximated 50th percentiles; geometric standard deviations were 1.2-1.3 for HR, 1.5-1.8 for VR.  
<sup>c</sup> EL = elementary school student; HS = high school student.  
<sup>d</sup> N = number of students that participated in survey.  
<sup>e</sup> Highest single value.

Source: Spier et al., 1992.

Table 5-4. Average Hours Spent Per Day in a Given Location and Activity Level for Elementary (EL) and High School (HS) Students

Student (EL <sup>a</sup> , n <sup>c</sup> =17; HS <sup>b</sup> , N <sup>c</sup> =19)	Location	Activity Level			Total Time Spent (hrs/day)
		Slow	Medium	Fast	
EL	Indoor	16.3	2.9	0.4	19.6
EL	Outdoor	2.2	1.7	0.5	4.4
HS	Indoor	19.5	1.5	0.2	21.2
HS	Outdoor	1.2	1.3	0.2	2.7

<sup>a</sup> Elementary school (EL) students were between 10-12 years old.  
<sup>b</sup> High school (HS) students were between 13-17 years old.  
<sup>c</sup> N corresponds to number of school students.

Source: Spier et al., 1992.



Table 5-5. Distribution Patterns of Daily Inhalation Rates for Elementary (EL) and High School (HS) Students Grouped by Activity Level

Students	Age (yrs)	Location	Activity type <sup>a</sup>	Mean IR <sup>b</sup> (m <sup>3</sup> /day)	Percentile Rankings		
					1st	50th	99.9th
EL (n <sup>c</sup> =17)	10-12	Indoor	Light	13.7	2.93	12.71	38.14
			Moderate	2.8	0.70	2.44	7.48
			Heavy	0.4	0.096	0.34	1.37
EL		Outdoor	Light	2.1	0.79	1.72	9.50
			Moderate	1.84	0.41	1.63	5.71
			Heavy	0.57	0.24	0.48	1.80
HS (n=19)	13-17	Indoor	Light	15.2	5.85	14.04	63.18
			Moderate	1.4	0.63	1.26	6.03
			Heavy	0.25	0.11	0.22	1.37
HS		Outdoor	Light	1.15	0.50	1.08	6.34
			Moderate	1.64	0.62	1.40	7.41
			Heavy	0.29	0.096	0.20	1.19

<sup>a</sup> For this report, activity type presented in Table 5-2 was redefined as light activity for slow, moderate activity for medium, and heavy activity for fast.  
<sup>b</sup> Daily inhalation rate was calculated by multiplying the hours spent at each activity level (Table 5-4) by the corresponding inhalation rate (Table 5-3).  
<sup>c</sup> Number of elementary (EL) and high school students (HS).

Source: Adapted from Spier et al., 1992 (Generated using data from Tables 5-3 and 5-4).

A limitation of this study is the small sample size. The results may not be representative of all children in these age groups. Another limitation is that the accuracy of the self-estimated breathing rates reported by younger age groups is uncertain. This may affect the validity of the data set generated. An advantage of this study is that inhalation rates were determined for children and adolescents. These data are useful in estimating exposure for the younger population.

Adams (1993) - *Measurement of Breathing Rate and Volume in Routinely Performed Daily Activities* - Adams (1993) conducted research to accomplish two main objectives: (1) identification of mean and ranges of inhalation rates for various age/gender cohorts and specific activities; and (2) derivation of simple linear and multiple regression equations used to predict inhalation rates through other measured variables: heart rate (HR), breathing frequency ( $f_b$ ), and oxygen consumption ( $V_{O_2}$ ). A total of 160 subjects participated in the primary study. There were four age dependent groups: (1) children 6 to 12.9 years old, (2) adolescents between 13 and 18.9 years old, (3) adults between 19 and 59.9 years old, and (4) seniors >60 years old (Adams, 1993). An additional 40 children from 6 to 12 years old and 12 young children from 3 to 5 years old were

identified as subjects for pilot testing purposes in this age group (Adams, 1993).

Resting protocols conducted in the laboratory for all age groups consisted of three phases (25 minutes each) of lying, sitting, and standing. They were categorized as resting and sedentary activities. Two active protocols, moderate (walking) and heavy (jogging/ running) phases, were performed on a treadmill over a progressive continuum of intensities made up of 6 minute intervals, at 3 speeds, ranging from slow to moderately fast. All protocols involved measuring VR, HR,  $f_b$  (breathing frequency), and  $V_{O_2}$  (oxygen consumption). Measurements were taken in the last 5 minutes of each phase of the resting protocol, and the last 3 minutes of the 6 minute intervals at each speed designated in the active protocols.

In the field, all children completed spontaneous play protocols, while the older adolescent population (16-18 years) completed car driving and riding, car maintenance (males), and housework (females) protocols. All adult females (19-60 years) and most of the senior (60-77 years) females completed housework, yardwork, and car driving and riding protocols. Adult and senior males completed car driving and riding, yardwork, and mowing protocols. HR, VR, and  $f_b$  were measured during each protocol. Most



protocols were conducted for 30 minutes. All the active field protocols were conducted twice.

During all activities in either the laboratory or field protocols, IR for the children's group revealed no significant gender differences, but those for the adult groups demonstrated gender differences. Therefore, IR data presented in Appendix Tables 5A-1 and 5A-2 were categorized as young children, children (no gender), and for adult female, and adult male by activity levels (resting, sedentary, light, moderate, and heavy). These categorized data from the Appendix tables are summarized as IR in m<sup>3</sup>/hr in Tables 5-6 and 5-7. The laboratory protocols are shown in Table 5-6. Table 5-7 presents the mean inhalation rates by group and activity levels (light, sedentary, and moderate) in field protocols. A comparison of the data shown in Tables 5-6 and 5-7 suggest that during light and sedentary activities in laboratory and field protocols, similar inhalation rates were obtained for adult females and adult males. Accurate predictions of IR across all population groups and activity types were obtained by including body surface area (BSA), HR, and  $f_B$  in multiple regression analysis (Adams, 1993). Adams (1993) calculated BSA from measured height and weight using the equation:

$$BSA = \text{Height}^{(0.725)} \times \text{Weight}^{(0.425)} \times 71.84. \quad (\text{Eqn. 5-2})$$

A limitation associated with this study is that the population does not represent the general U.S. population. Also, the classification of activity types (i.e., laboratory and field protocols) into activity levels may bias the inhalation rates obtained for various age/gender cohorts. The estimated rates were based on short-term data and may not reflect long-term patterns. An advantage of this study is that it provides inhalation data for all age groups.

*Linn et al. (1993) - Activity patterns in Ozone Exposed Construction Workers* - Linn et al. (1993) estimated the inhalation rates of 19 construction workers who perform heavy outdoor labor before and during a typical work shift. The workers (laborers, iron workers, and carpenters) were employed at a site on a hospital campus in suburban Los Angeles. The construction site included a new hospital building and a separate medical office complex. The study was conducted between mid-July and early November, 1991. During this period, ozone (O<sub>3</sub>) levels were typically high. Initially, each subject was calibrated with a 25-minute exercise test that included slow walking, fast walking, jogging, lifting, and carrying. All calibration tests were conducted in the mornings. VR

Age Group	Resting <sup>a</sup>	Sedentary <sup>b</sup>	Light <sup>c</sup>	Moderate <sup>d</sup>	Heavy <sup>e</sup>
Young Children <sup>f</sup>	0.37	0.40	0.65	DNP <sup>g</sup>	DNP
Children <sup>h</sup>	0.45	0.47	0.95	1.74	2.23
Adult Females <sup>i</sup>	0.43	0.48	1.33	2.76	2.96 <sup>j</sup>
Adult Males <sup>k</sup>	0.54	0.60	1.45	1.93	3.63

<sup>a</sup> Resting defined as lying (see Appendix Table 5A-1 for original data).  
<sup>b</sup> Sedentary defined as sitting and standing (see Appendix Table 5A-1 for original data).  
<sup>c</sup> Light defined as walking at speed level 1.5 - 3.0 mph (see Appendix Table 5A-1 for original data).  
<sup>d</sup> Moderate defined as fast walking (3.3 - 4.0 mph) and slow running (3.5 - 4.0 mph) (see Appendix Table 5A-1 for original data).  
<sup>e</sup> Heavy defined as fast running (4.5 - 6.0 mph) (see Appendix Table 5A-1 for original data).  
<sup>f</sup> Young children (both genders) 3 - 5.9 yrs old.  
<sup>g</sup> DNP. Group did not perform this protocol or N was too small for appropriate mean comparisons. All young children did not run.  
<sup>h</sup> Children (both genders) 6 - 12.9 yrs old.  
<sup>i</sup> Adult females defined as adolescent, young to middle aged, and older adult females.  
<sup>j</sup> Older adults not included in mean value since they did not perform running protocols at particular speeds.  
<sup>k</sup> Adult males defined as adolescent, young to middle aged, and older adult males.

Source: Adapted from Adams, 1993.

Table 5-7. Summary of Average Inhalation Rates (m<sup>3</sup>/hr) by Age Group and Activity Levels in Field Protocols

Age Group	Light <sup>a</sup>	Sedentary <sup>b</sup>	Moderate <sup>c</sup>
-----------	--------------------	------------------------	-----------------------



Young Children <sup>d</sup>	DNP <sup>e</sup>	DNP	0.68
Children <sup>f</sup>	DNP	DNP	1.07
Adult Females <sup>g</sup>	1.10 <sup>h</sup>	0.51	DNP
Adult Males <sup>i</sup>	1.40	0.62	1.78 <sup>j</sup>

- <sup>a</sup> Light activity was defined as car maintenance (males), housework (females), and yard work (females) (see Appendix Table 5A-2 for original data).
  - <sup>b</sup> Sedentary activity was defined as car driving and riding (both genders) (see Appendix Table 5A-2 for original data).
  - <sup>c</sup> Moderate activity was defined as mowing (males); wood working (males); yard work (males); and play (children) (see Appendix Table 5A-2 for original data).
  - <sup>d</sup> Young children (both genders) = 3 - 5.9 yrs old.
  - <sup>e</sup> DNP. Group did not perform this protocol or N was too small for appropriate mean comparisons.
  - <sup>f</sup> Children (both genders) = 6 - 12.9 yrs old.
  - <sup>g</sup> Adult females defined as adolescent, young to middle aged, and older adult females.
  - <sup>h</sup> Older adults not included in mean value since they did not perform this activity.
  - <sup>i</sup> Adult males defined as adolescent, young to middle aged, and older adult males.
  - <sup>j</sup> Adolescents not included in mean value since they did not perform this activity.
- Source: Adams, 1993.

subgroups are presented in Table 5-8. The data reflect all recordings before and during work, and at break times. For all subjects, the mean IR was 1.68 m<sup>3</sup>/hr with a standard deviation of ±0.72 (Table 5-8). Also, for most subjects, the 1st and 99th percentiles of HR were outside of the calibration range (calibration ranges are presented in Appendix Table 5A-3). Therefore, corresponding IR percentiles were extrapolated using the calibration data (Linn et al., 1993).

The data presented in Table 5-9 represent distribution patterns of IR for each subject, total subjects, and job or site defined subgroups by self-estimated breathing rates (slow, medium, fast) or by type of job activity. All data include working and non-working hours. The mean inhalation rates for most individuals showed statistically significant increases with higher self-estimated breathing rates or with increasingly strenuous job activity (Linn et al., 1993). Inhalation rates were higher in hospital site workers when compared with office site workers (Table 5-9). In spite of their higher predicted VR workers at the hospital site reported a higher percentage of slow breathing time (31 percent) than workers at the office site (20 percent), and a lower percentage of fast breathing time, 3 percent and 5 percent, respectively (Linn et al., 1993). Therefore, individuals whose work was objectively heavier than average (from VR predictions) tended to describe their work as lighter than average (Linn et al., 1993). Linn et al. (1993) also concluded that during an O<sub>3</sub> pollution episode, construction workers should experience similar microenvironmental O<sub>3</sub> exposure concentrations as other healthy outdoor workers, but with approximately twice as high a VR. Therefore, the inhaled dose of O<sub>3</sub> should be almost two times higher for typical heavy-construction workers than for typical healthy adults performing less strenuous outdoor jobs.

A limitation associated with this study is the small sample size. Another limitation of this study is that calibration data were not obtained at extreme conditions.

and HR were measured simultaneously during the test. The data were analyzed using least squares regression to derive an equation for predicting VR at a given HR. Following the calibration tests, each subject recorded the type of activities to be performed during their work shift (i.e., sitting/standing, walking, lifting/carrying, and "working at trade" - defined as tasks specific to the individual's job classification). Location, and self-estimated breathing rates ("slow" similar to slow walking, "medium" similar to fast walking, and "fast" similar to running) were also recorded in the diary. During work, an investigator recorded the diary information dictated by the subjects. HR was recorded minute by minute for each subject before work and during the entire work shift. Thus, VR ranges for each breathing rate and activity category were estimated from the HR recordings by employing the relationship between VR and HR obtained from the calibration tests.

A total of 182 hours of HR recordings were obtained during the survey from the 19 volunteers; 144 hours reflected actual working time according to the diary records. The lowest actual working hours recorded was 6.6 hours and the highest recorded for a complete work shift was 11.6 hours (Linn et al., 1993). Summary statistics for predicted VR distributions for all subjects, and for job or site defined



Table 5-8. Distributions of Individual and Group Inhalation/Ventilation Rate for Outdoor Workers				
Population Group and Subgroup <sup>a</sup>	Mean ± SD	Ventilation Rate (VR) (m <sup>3</sup> /hr)		
		Percentile		
		1	50	99
All Subjects (n <sup>b</sup> = 19)	1.68 ± 0.72	0.66	1.62	3.90
<b>Job</b>				
GCW <sup>c</sup> /Laborers (n=5)	1.44 ± 0.66	0.48	1.32	3.66
Iron Workers (n=3)	1.62 ± 0.66	0.60	1.56	3.24
Carpenters (n=11)	1.86 ± 0.78	0.78	1.74	4.14
<b>Site</b>				
Medical Office Site (n=7)	1.38 ± 0.66	0.60	1.20	3.72
Hospital Site (n=12)	1.86 ± 0.78	0.72	1.80	3.96

<sup>a</sup> Each group or subgroup mean was calculated from individual means, not from pooled data.  
<sup>b</sup> n = number of individuals performing specific jobs or number of individuals at survey sites.  
<sup>c</sup> GCW - general construction worker.

Source: Linn et al., 1993.

Table 5-9. Individual Mean Inhalation Rate (m <sup>3</sup> /hr) by Self-Estimated Breathing Rate or Job Activity Category for Outdoor Workers							
Population Group and Subgroup	Self-Estimated Breathing Rate (m <sup>3</sup> /hr)			Job Activity Category (m <sup>3</sup> /hr)			
	Slow	Med	Fast	Sit/Std	Walk	Carry	Trade <sup>b</sup>
All Subjects (n=19)	1.44	1.86	2.04	1.56	1.80	2.10	1.92
<b>Job</b>							
GCW <sup>a</sup> /Laborers (n=5)	1.20	1.56	1.68	1.26	1.44	1.74	1.56
Iron Workers (n=3)	1.38	1.86	2.10	1.62	1.74	1.98	1.92
Carpenters (n=11)	1.62	2.04	2.28	1.62	1.92	2.28	2.04
<b>Site</b>							
Office Site (n=7)	1.14	1.44	1.62	1.14	1.38	1.68	1.44
Hospital Site (n=12)	1.62	2.16	2.40	1.80	2.04	2.34	2.16

<sup>a</sup> GCW - general construction worker  
<sup>b</sup> Trade - "Working at Trade" (i.e., tasks specific to the individual's job classification)

Source: Linn et al., 1993

Therefore, it was necessary to predict IR values that were outside the calibration range. This may introduce an unknown amount of uncertainty to the data set. Subjective

self-estimated breathing rates may be another source of uncertainty in the inhalation rates estimated. An advantage is that this study provides empirical data useful in exposure



assessments for a subpopulation thought to be the most highly exposed common occupational group (outdoor workers).

Layton (1993) - *Metabolically Consistent Breathing Rates for Use in Dose Assessments* - Layton (1993) presented a new method for estimating metabolically consistent inhalation rates for use in quantitative dose assessments of airborne radionuclides. Generally, the approach for estimating the breathing rate for a specified time frame was to calculate a time-weighted-average of ventilation rates associated with physical activities of varying durations (Layton, 1993). However, in this study, breathing rates were calculated based on oxygen consumption associated with energy expenditures for short (hours) and long (weeks and months) periods of time, using the following general equation to calculate energy-dependent inhalation rates:

$V_E = E \times H \times VQ$ <p>where:</p> <p><math>V_E</math> = ventilation rate (L/min or m<sup>3</sup>/hr);</p> <p><math>E</math> = energy expenditure rate; [kilojoules/minute (KJ/min) or megajoules/hour (MJ/hr)];</p> <p><math>H</math> = volume of oxygen [at standard temperature and pressure, dry air (STPD) consumed in the production of 1 kilojoule (KJ) of energy expended (L/KJ or m<sup>3</sup>/MJ)]; and</p> <p><math>VQ</math> = ventilatory equivalent (ratio of minute volume (L/min) to oxygen uptake (L/min)) unitless.</p>	(Eqn. 5-3)
--	------------

Three alternative approaches were used to estimate daily chronic (long term) inhalation rates for different age/gender cohorts of the U.S. population using this methodology.

First Approach

Inhalation rates were estimated by multiplying average daily food energy intakes for different age/gender cohorts, volume of oxygen (H), and ventilatory equivalent (VQ), as shown in the equation above. The average food energy intake data (Table 5-10) are based on approximately 30,000 individuals and were obtained from the USDA 1977-78 Nationwide Food Consumption Survey (USDA-NFCS). The food energy intakes were adjusted upwards by a constant factor of 1.2 for all individuals 9 years and older (Layton, 1993). This factor compensated for a consistent bias in USDA-NFCS attributed to under reporting of the foods consumed or the methods used to ascertain dietary intakes. Layton (1993) used a weighted average oxygen uptake of 0.05 L O<sub>2</sub>/KJ which was determined from data

reported in the 1977-78 USDA-NFCS and the second National Health and Nutrition Examination Survey (NHANES II). The survey sample for NHANES II was approximately 20,000 participants. The ventilatory equivalent (VQ) of 27 used was calculated as the geometric mean of VQ data that were obtained from several studies by Layton (1993).

The inhalation rate estimation techniques are shown in footnote (a) of Table 5-11. Table 5-11 presents the daily inhalation rate for each age/gender cohort. The highest daily inhalation rates were reported for children between the ages of 6-8 years (10 m<sup>3</sup>/day), for males between 15-18 years (17 m<sup>3</sup>/day), and females between 9-11 years (13 m<sup>3</sup>/day). Estimated average lifetime inhalation rates for males and females are 14 m<sup>3</sup>/day and 10<sup>3</sup> m<sup>3</sup>/day, respectively (Table 5-11). Inhalation rates were also calculated for active and inactive periods for the various age/gender cohorts.

The inhalation rate for inactive periods was estimated by multiplying the basal metabolic rate (BMR) times the oxygen uptake (H) times the VQ. BMR was defined as "the minimum amount of energy required to support basic cellular respiration while at rest and not actively digesting food" (Layton, 1993). The inhalation rate for active periods was calculated by multiplying the inactive inhalation rate by the ratio of the rate of energy expenditure during active hours to the estimated BMR. This ratio is presented as F in Table 5-11. These data for active and inactive inhalation rates are also presented in Table 5-11. For children, inactive and active inhalation rates ranged between 2.35 and 5.95 m<sup>3</sup>/day and 6.35 to 13.09 m<sup>3</sup>/day, respectively. For adult males (19-64 years old), the average inactive and active inhalation rates were approximately 10 and 19 m<sup>3</sup>/day, respectively. Also, the average inactive and active inhalation rates for adult females (19-64 years old) were approximately 8 and 12 m<sup>3</sup>/day, respectively.

Second Approach

Inhalation rates were calculated by multiplying the BMR of the population cohorts times A (ratio of total daily energy expenditure to daily BMR) times H times VQ. The BMR data obtained from literature were statistically analyzed and regression equations were developed to predict BMR from body weights of various age/gender cohorts (Layton, 1993). The statistical data used to develop the regression equations are presented in Appendix Table 5A-4. The data obtained from the second



Table 5-10. Comparisons of Estimated Basal Metabolic Rates (BMR) with Average Food-Energy Intakes for Individuals Sampled in the 1977-78 NFCS

Cohort/Age (years)	Body Weight kg	BMR <sup>a</sup>		Energy Intake (EFD)		Ratio EFD/BMR
		MJ d <sup>-1b</sup>	kcal d <sup>-1c</sup>	MJ d <sup>-1</sup>	kcal d <sup>-1</sup>	
<b>Children</b>						
Under 1	7.6	1.74	416	3.32	793	1.90
1 to 2	13	3.08	734	5.07	1209	1.65
3 to 5	18	3.69	881	6.14	1466	1.66
6 to 8	26	4.41	1053	7.43	1774	1.68
<b>Males</b>						
9 to 11	36	5.42	1293	8.55	2040	1.58
12 to 14	50	6.45	1540	9.54	2276	1.48
15 to 18	66	7.64	1823	10.8	2568	1.41
19 to 22	74	7.56	1804	10.0	2395	1.33
23 to 34	79	7.87	1879	10.1	2418	1.29
35 to 50	82	7.59	1811	9.51	2270	1.25
51 to 64	80	7.49	1788	9.04	2158	1.21
65 to 74	76	6.18	1476	8.02	1913	1.30
75 +	71	5.94	1417	7.82	1866	1.32
<b>Females</b>						
9 to 11	36	4.91	1173	7.75	1849	1.58
12 to 14	49	5.64	1347	7.72	1842	1.37
15 to 18	56	6.03	1440	7.32	1748	1.21
19 to 22	59	5.69	1359	6.71	1601	1.18
23 to 34	62	5.88	1403	6.72	1603	1.14
35 to 50	66	5.78	1380	6.34	1514	1.10
51 to 64	67	5.82	1388	6.40	1528	1.10
65 to 74	66	5.26	1256	5.99	1430	1.14
75 +	62	5.11	1220	5.94	1417	1.16
<sup>a</sup> Calculated from the appropriate age and gender-based BMR equations given in Appendix Table 5A-4. <sup>b</sup> MJ d <sup>-1</sup> - mega joules/day <sup>c</sup> kcal d <sup>-1</sup> - kilo calories/day Source: Layton, 1993.						



Table 5-11. Daily Inhalation Rates Calculated from Food-Energy Intakes

Cohort/Age (years)	L <sup>d</sup>	Daily Inhalation Rate <sup>a</sup>		MET <sup>b</sup> Value		Inhalation Rates	
		(m <sup>3</sup> /day)	Sleep (h)	A <sup>e</sup>	F <sup>f</sup>	Inactive <sup>c</sup> (m <sup>3</sup> /day)	Active <sup>c</sup> (m <sup>3</sup> /day)
<b>Children</b>							
<1	1	4.5	11	1.9	2.7	2.35	6.35
1 - 2	2	6.8	11	1.6	2.2	4.16	9.15
3 - 5	3	8.3	10	1.7	2.2	4.98	10.96
6 - 8	3	10	10	1.7	2.2	5.95	13.09
<b>Males</b>							
9 - 11	3	14	9	1.9	2.5	7.32	18.3
12 - 14	3	15	9	1.8	2.2	8.71	19.16
15 - 18	4	17	8	1.7	2.1	10.31	21.65
19 - 22	4	16	8	1.6	1.9	10.21	19.4
23 - 34	11	16	8	1.5	1.8	10.62	19.12
35 - 50	16	15	8	1.5	1.8	10.25	18.45
51 - 64	14	15	8	1.4	1.7	10.11	17.19
65 - 74	10	13	8	1.6	1.8	8.34	15.01
75+	1	13	8	1.6	1.9	8.02	15.24
Lifetime average <sup>g</sup>		14					
<b>Females</b>							
9 - 11	3	13	9	1.9	2.5	6.63	16.58
12 - 14	3	12	9	1.6	2.0	7.61	15.20
15 - 18	4	12	8	1.5	1.7	8.14	13.84
19 - 22	4	11	8	1.4	1.6	7.68	12.29
23 - 34	11	11	8	1.4	1.6	7.94	12.7
35 - 50	16	10	8	1.3	1.5	7.80	11.7
51 - 64	14	10	8	1.3	1.5	7.86	11.8
65 - 74	10	9.7	8	1.4	1.5	7.10	10.65
75+	1	9.6	8	1.4	1.6	6.90	11.04
Lifetime average <sup>g</sup>		10					

<sup>a</sup> Daily inhalation rate was calculated by multiplying the EFD values (see Table 5-10) by H x VQ x (m<sup>3</sup> 1,000 L<sup>-1</sup>) for subjects under 9 years of age and by 1.2 x H x VQ x (m<sup>3</sup> 1,000 L<sup>-1</sup>) (for subjects 9 years of age and older (see text for explanation).

Where:

- EFD = Food energy intake (Kcal/day) or (MJ/day)
- H = Oxygen uptake = 0.05 LO<sub>2</sub>/KJ or 0.21 LO<sub>2</sub>/Kcal
- VQ = Ventilation equivalent = 27 = geometric mean of VQs (unitless)

<sup>b</sup> MET = Metabolic equivalent

<sup>c</sup> Inhalation rate for inactive periods was calculated as BMR x H x VQ x (d 1,440 min<sup>-1</sup>) and for active periods by multiplying inactive inhalation rate by F (See footnote f); BMR values are from Table 5-10.

Where:

- BMR = Basal metabolic rate (MJ/day) or (kg/hr)

<sup>d</sup> L is the number of years for each age cohort.

<sup>e</sup> For individuals 9 years of age and older, A was calculated by multiplying the ratio for EFD/BMR (unitless) (Table 5-10) by the factor 1.2 (see text for explanation).

<sup>f</sup> F = (24A - S)/(24 - S) (unitless), ratio of the rate of energy expenditure during active hours to the estimated BMR (unitless)

Where:

- S = Number of hours spent sleeping each day (hrs)

<sup>g</sup> Lifetime average was calculated by multiplying individual inhalation rate by corresponding L values summing the products across cohorts and dividing the result by 75, the total of the cohort age spans.

Source: Lavton, 1993.





approach are presented in Table 5-12. Inhalation rates for children (6 months - 10 years) ranged from 7.3-9.3 m<sup>3</sup>/day for male and 5.6 to 8.6 m<sup>3</sup>/day for female children and (10-18 years) was 15 m<sup>3</sup>/day for males and 12 m<sup>3</sup>/day for females. Adult females (18 years and older) ranged from 9.9-11 m<sup>3</sup>/day and adult males (18 years and older) ranged from 13-17 m<sup>3</sup>/day. These rates are similar to the daily inhalation rates obtained using the first approach. Also, the inactive inhalation rates obtained from the first approach are lower than the inhalation rates obtained using the second approach. This may be attributed to the BMR multiplier employed in the equation of the second approach to calculate inhalation rates.

**Third Approach**

Inhalation rates were calculated by multiplying estimated energy expenditures associated with different levels of physical activity engaged in over the course of an average day by VQ and H for each age/gender cohort. The energy expenditure associated with each level of activity was estimated by multiplying BMRs of each activity level by the metabolic equivalent (MET) and by the time spent per day performing each activity for each age/gender population. The time-activity data used in this approach were obtained from a survey conducted by Sallis et al. (1985) (Layton, 1993). In that survey, the physical-activity categories and associated MET values used were

sleep, MET=1; light-activity, MET=1.5; moderate activity, MET=4; hard activity, MET=6; and very hard activity, MET=10. The physical activities were based on recall by the test subject (Layton, 1993). The survey sample was 2,126 individuals (1,120 women and 1,006 men) ages 20-74 years that were randomly selected from four communities in California. The BMRs were estimated using the metabolic equations presented in Appendix Table 5A-4. The body weights were obtained from a study conducted by Najjar and Rowland (1987) which randomly sampled individuals from the U.S. population (Layton, 1993). Table 5-13 presents the inhalation rates (V<sub>E</sub>) in m<sup>3</sup>/day and m<sup>3</sup>/hr for adult males and females aged 20-74 years at five physical activity levels. The total daily inhalation rates ranged from 13-17 m<sup>3</sup>/day for adult males and 11-15 m<sup>3</sup>/day for adult females.

The rates for adult females were higher when compared with the other two approaches. Layton (1993) reported that the estimated inhalation rates obtained from the third approach were particularly sensitive to the MET value that represented the energy expenditures for light activities. Layton (1993) stated further that in the original time-activity survey (i.e., conducted by Sallis et al., 1985), time spent performing light activities was not presented. Therefore, the time spent at light activities was estimated

Table 5-12. Daily Inhalation Rates Obtained from the Ratios of Total Energy Expenditure to Basal Metabolic Rate (BMR)

Gender/Age (yrs)	Body Weight <sup>a</sup> (kg)	BMR <sup>b</sup> (MJ/day)	VQ	A <sup>c</sup>	H (m <sup>3</sup> O <sub>2</sub> /MJ)	Inhalation Rate, V <sub>E</sub> (m <sup>3</sup> /day) <sup>d</sup>
<b>Male</b>						
0.5 - <3	14	3.4	27	1.6	0.05	7.3
3 - <10	23	4.3	27	1.6	0.05	9.3
10 - <18	53	6.7	27	1.7	0.05	15
18 - <30	76	7.7	27	1.59	0.05	17
30 - <60	80	7.5	27	1.59	0.05	16
60+	75	6.1	27	1.59	0.05	13
<b>Female</b>						
0.5 - <3	11	2.6	27	1.6	0.05	5.6
3 - <10	23	4.0	27	1.6	0.05	8.6
10 - <18	50	5.7	27	1.5	0.05	12
18 - <30	62	5.9	27	1.38	0.05	11
30 - <60	68	5.8	27	1.38	0.05	11
60+	67	5.3	27	1.38	0.05	9.9

<sup>a</sup> Body weight was based on the average weights for age/gender cohorts in the U.S. population.

<sup>b</sup> The BMRs (basal metabolic rate) are calculated using the respective body weights and BMR equations (see Appendix Table 5A-4).

<sup>c</sup> The values of the BMR multiplier (EFD/BMR) for those 18 years and older were derived from the Basiotis et al. (1989) study: Male = 1.59, Female = 1.38. For males and females under 10 years old, the mean BMR multiplier used was 1.6. For males and females aged 10 to < 18 years, the mean values for A given in Table 5-11 for 12-14 years and 15-18 years, age brackets for males and females were used: male = 1.7 and female = 1.5.

<sup>d</sup> Inhalation rate = BMR x A x H x VQ; VQ = ventilation equivalent and H = oxygen uptake.

Source: Layton, 1993.



Table 5-13. Daily Inhalation Rates Based on Time-Activity Survey

Age (yrs) and Activity	MET	Males						Females					
		Body Weight <sup>a</sup> (kg)	BMR <sup>b</sup> (KJ/hr)	Duration <sup>c</sup> (hr/day)	E <sup>d</sup> (MJ/day)	V <sub>E</sub> <sup>e</sup> (m <sup>3</sup> /day)	V <sub>E</sub> <sup>f</sup> (m <sup>3</sup> /hr)	Body Weight <sup>a</sup> (kg)	BMR <sup>b</sup> (KJ/hr)	Duration <sup>c</sup> (hr/day)	E <sup>d</sup> (MJ/day)	V <sub>E</sub> <sup>e</sup> (m <sup>3</sup> /day)	V <sub>E</sub> <sup>f</sup> (m <sup>3</sup> /hr)
		20-34											
Sleep	1	76	320	7.2	2.3	3.1	0.4	62	283	7.2	2.0	2.8	0.4
Light	1.5	76	320	14.5	7.0	9.4	0.7	62	283	14.5	6.2	8.3	0.6
Moderate	4	76	320	1.2	1.5	2.1	1.7	62	283	1.2	1.4	1.8	1.5
Hard	6	76	320	0.64	1.2	1.7	2.6	62	283	0.64	1.1	1.5	2.3
Very Hard	10	76	320	0.23	0.74	1.0	4.3	62	283	0.23	0.65	0.88	3.8
<b>Totals</b>				24	17	17				24	11	15	
35-49													
Sleep	1	81	314	7.1	2.2	3.0	0.4	67	242	7.1	1.7	2.3	0.3
Light	1.5	81	314	14.6	6.9	9.3	0.6	67	242	14.6	5.3	7.2	0.5
Moderate	4	81	314	1.4	1.8	2.4	1.7	67	242	1.4	1.4	1.8	1.3
Hard	6	81	314	0.59	1.1	1.5	2.5	67	242	0.59	0.9	1.2	2.0
Very Hard	10	81	314	0.29	0.91	1.2	4.2	67	242	0.29	0.70	0.95	3.2
<b>Totals</b>				24	13	17				24	9.9	13	
50-64													
Sleep	1	80	312	7.3	2.3	3.1	0.4	68	244	7.3	1.8	2.4	0.3
Light	1.5	80	312	14.9	7.0	9.4	0.6	68	244	14.9	5.4	7.4	0.5
Moderate	4	80	312	1.1	1.4	1.9	1.7	68	244	1.1	1.1	1.4	1.3
Hard	6	80	312	0.50	0.94	1.3	2.5	68	244	0.5	0.7	1.0	2.0
Very Hard	10	80	312	0.14	0.44	0.6	4.2	68	244	0.14	0.34	0.46	3.3
<b>Totals</b>				24	12	16				24	9.4	13	
65-74													
Sleep	1	75	256	7.3	1.9	2.5	0.3	67	221	7.3	1.6	2.2	0.3
Light	1.5	75	256	14.9	5.7	7.7	0.5	67	221	14.9	4.9	6.7	0.4
Moderate	4	75	256	1.1	1.1	1.5	1.4	67	221	1.1	1.0	1.3	1.2
Hard	6	75	256	0.5	0.8	1.0	2.1	67	221	0.5	0.7	0.9	1.8
Very Hard	10	75	256	0.14	0.36	0.48	3.5	67	221	0.14	0.31	0.42	3.0
<b>Totals</b>				24	9.8	13				24	8.5	11	

<sup>a</sup> Body weights were obtained from Najjar and Rowland (1987)  
<sup>b</sup> The basal metabolic rates (BMRs) for the age/gender cohorts were calculated using the respective body weights and the BMR equations (Appendix Table 5A-4)  
<sup>c</sup> Duration of activities were obtained from Sallis et al. (1985)  
<sup>d</sup> Energy expenditure rate (E) was calculated by multiplying BMR (KJ/hr) x (MJ/1000 KJ) x duration (hr/day) x MET  
<sup>e</sup> V<sub>E</sub> (inhalation rate) was calculated by multiplying E (MJ/day) by H(0.05 m<sup>3</sup> oxygen/MJ) by VQ (27)  
<sup>f</sup> V<sub>E</sub> (m<sup>3</sup>/hr) was calculated by multiplying BMR (KJ/hr) x (MJ/1000 KJ) x MET x H (0.05 m<sup>3</sup> oxygen/MJ) x VQ (27)

Source: Layton, 1993.



by subtracting the total time spent at sleep, moderate, heavy, and very heavy activities from 24 hours (Layton, 1993). The range of inhalation rates for adult females were 9.6 to 11 m<sup>3</sup>/day, 9.9 to 11 m<sup>3</sup>/day, and 11 to 15 m<sup>3</sup>/day, for the first, second, and third approach, respectively. The inhalation rates for adult males ranged from 13 to 16 m<sup>3</sup>/day for the first approach, and 13 to 17 m<sup>3</sup>/day for the second and third approaches.

Inhalation rates were also obtained for short-term exposures for various age/gender cohorts and five energy-expenditure categories (rest, sedentary, light, moderate, and heavy). BMRs were multiplied by the product of MET, H, and VQ. The data obtained for short term exposures are presented in Table 5-14.

The major strengths of the Layton (1993) study are that it obtains similar results using three different approaches to estimate inhalation rates in different age groups and that the populations are large, consisting of men, women, and children. Explanations for differences in results due to metabolic measurements, reported diet, or activity patterns are supported by observations reported by other investigators in other studies. Major limitations of this study are that activity pattern levels estimated in

this study are somewhat subjective, the explanation that activity pattern differences is responsible for the lower level obtained with the metabolic approach (25 percent) compared to the activity pattern approach is not well supported by the data, and different populations were used in each approach which may introduce error.

**5.2.3. Relevant Inhalation Rate Studies**

*International Commission on Radiological Protection (ICRP) (1981) - Report of the Task Group on Reference Man* - The International Commission of Radiological Protection (ICRP) estimated daily inhalation rates for reference adult males, adult females, children (10 years old), infant (1 year old), and newborn babies by using a time-activity-ventilation approach. This approach for estimating inhalation rate over a specified period of time was based on calculating a time weighted average of inhalation rates associated with physical activities of varying durations. ICRP (1981) compiled reference values (Appendix Table 5A-5) of minute volume/inhalation rates from various literature sources. ICRP (1981) assumed that the daily activities of a reference man and woman, and child (10 yrs) consisted of

Table 5-14. Inhalation Rates for Short-Term Exposures

Gender/Age (yrs)	Weight (kg) <sup>a</sup>	BMR <sup>b</sup> (MJ/day)	Activity Type				
			Rest	Sedentary	Light	Moderate	Heavy
			MET (BMR Multiplier)				
			1	1.2	2 <sup>c</sup>	4 <sup>d</sup>	10 <sup>e</sup>
Inhalation Rate (m <sup>3</sup> /hr) <sup>f,g</sup>							
<b>Male</b>							
0.5 - <3	14	3.40	0.19	0.23	0.38	0.78	1.92
3 - <10	23	4.30	0.24	0.29	0.49	0.96	2.40
10 - <18	53	6.70	0.38	0.45	0.78	1.50	3.78
18 - <30	76	7.70	0.43	0.52	0.84	1.74	4.32
30 - <60	80	7.50	0.42	0.50	0.84	1.68	4.20
60+	75	6.10	0.34	0.41	0.66	1.38	3.42
<b>Female</b>							
0.5 - <3	11	2.60	0.14	0.17	0.29	0.60	1.44
3 - <10	23	4.00	0.23	0.27	0.45	0.90	2.28
10 - <18	50	5.70	0.32	0.38	0.66	1.26	3.18
18 - <30	62	5.90	0.33	0.40	0.66	1.32	3.30
30 - <60	68	5.80	0.32	0.39	0.66	1.32	3.24
60+	67	5.30	0.30	0.36	0.59	1.20	3.00

<sup>a</sup> Body weights were based on average weights for age/gender cohorts of the U.S. population  
<sup>b</sup> The BMRs for the age/gender cohorts were calculated using the respective body weights and the BMR equations (Appendix Table 5A-4).  
<sup>c</sup> Range of 1.5 - 2.5.  
<sup>d</sup> Range of 3 - 5.  
<sup>e</sup> Range of >5 - 20.  
<sup>f</sup> The inhalation rate was calculated by multiplying BMR (MJ/day) x H (0.05 L/KJ) x MET x VQ (27) x (d/1,440 min)  
<sup>g</sup> Original data were presented in L/min. Conversion to m<sup>3</sup>/hr was obtained as follows:

$$\frac{60 \text{ min}}{\text{hr}} \times \frac{\text{m}^3}{1000\text{L}} \times \frac{\text{L}}{\text{min}}$$

Source: Layton, 1993.



8 hours of rest and 16 hours of light activities. It was also assumed that 16 hours were divided evenly between occupational and nonoccupational activities. It was assumed that a day consisted of 14 hours resting and 10 hours light activity for an infant (1 yr). A newborn's daily activities consisted of 23 hours resting and 1 hour light activity. Table 5-15 presents the daily inhalation rates obtained for all ages/genders. The estimated inhalation rates were 22.8 m<sup>3</sup>/day for adult males, 21.1 m<sup>3</sup>/day for adult females, 14.8 m<sup>3</sup>/day for children (age 10 years), 3.76 m<sup>3</sup>/day for infants (age 1 year), and 0.78 m<sup>3</sup>/day for newborns.

Subject	Inhalation Rate (IR)		Daily Inhalation Rate (DIR) <sup>b</sup> (m <sup>3</sup> /day)
	Resting (m <sup>3</sup> /hr)	Light Activity (m <sup>3</sup> /hr)	
Adult Man	0.45	1.2	22.8
Adult Woman	0.36	1.14	21.1
Child (10 yrs)	0.29	0.78	14.8
Infant (1 yr)	0.09	0.25	3.76
Newborn	0.03	0.09	0.78

<sup>a</sup> Assumptions made were based on 8 hours resting and 16 hours light activity for adults and children (10 yrs); 14 hours resting and 10 hours light activity for infants (1 yr); 23 hours resting and 1 hour light activity for newborns.

<sup>b</sup>

$$DIR = \frac{1}{T} \sum_{i=1}^k IR_i t_i$$

IR<sub>i</sub> = Corresponding inhalation rate at i<sup>th</sup> activity  
 t<sub>i</sub> = Hours spent during the i<sup>th</sup> activity  
 k = Number of activity periods  
 T = Total time of the exposure period (i.e., a day)

Source: ICRP, 1981

as research objective itself and the available studies have been for specific subpopulations such as obese, asthmatics, or marathon runners. The data compiled by the U.S. EPA (1985) for each age/gender cohorts were obtained at various activity levels. These levels were categorized as light, moderate, or heavy according to the criteria developed by the EPA Office of Environmental Criteria and Assessment for the Ozone Criteria Document. These criteria were developed for a reference male adult with a body weight of 70 kg (U.S. EPA, 1985). The minute ventilation rates for adult males based on these activity level categories are detailed in Appendix Table 5A-6.

Table 5-16 presents a summary of inhalation rates by age, gender, and activity level (detailed data are presented in Appendix Table 5A-7). A description of activities included in each activity level is also presented in Table 5-16. Table 5-16 indicates that at rest, the average adult inhalation rate is 0.5 m<sup>3</sup>/hr. The mean inhalation rate for children at rest, ages 6 and 10 years, is 0.4 m<sup>3</sup>/hr. Table 5-17 presents activity pattern data aggregated for three microenvironments by activity level for all age groups. The total average hours spent indoors was 20.4, outdoors was 1.77, and in transportation vehicle was 1.77. Based on the data presented in Tables 5-16 and 5-17, a daily inhalation rate was calculated for adults and children by using a time-activity-ventilation approach. These data are presented in Table 5-18. The calculated average daily inhalation rate is 16 m<sup>3</sup>/day for adults. The average daily inhalation rate for children (6 and 10 yrs) is 18.9 m<sup>3</sup>/day ((16.74 + 21.02)/2).

A limitation associated with this study is that many of the values used in the data compilation were from early studies. The accuracy and/or validity of the values used and data collection method were not presented in U.S. EPA (1985). This introduces uncertainty in the results obtained. An advantage of this study is that the data are actual measurement data for a large number of subjects and the data are presented for both adults and children.

*Shamoo et al. (1990) - Improved Quantitation of Air Pollution Dose Rates by Improved Estimation of Ventilation Rate-* Shamoo et al. (1990) conducted this study to develop and validate new methods to accurately estimate ventilation rates for typical individuals during their normal activities. Two practical approaches were tested for estimating ventilation rates indirectly: (1) volunteers were trained to estimate their own VR at

A limitation associated with this study is that the validity and accuracy of the inhalation rates data used in the compilation were not specified. This may introduce some degree of uncertainty in the results obtained. Also, the approach used involved assuming hours spent by various age/gender cohorts in specific activities. These assumptions may over/under-estimate the inhalation rates obtained.

*U.S. EPA (1985) - Development of Statistical Distributions or Ranges of Standard Factors Used in Exposure Assessments* - Due to a paucity of information in the literature regarding equations used to develop statistical distributions of minute ventilation/ventilation rate at all activity levels for male and female children and adults, the U.S. EPA (1985) compiled measured values of minute ventilation for various age/gender cohorts from early studies. In more recent investigations, minute ventilations have been measured more as background information than



Table 5-16. Summary of Human Inhalation Rates for Men, Women, and Children by Activity Level (m<sup>3</sup>/hour)<sup>a</sup>

	n <sup>b</sup>	Resting <sup>c</sup>	n	Light <sup>d</sup>	n	Moderate <sup>e</sup>	n	Heavy <sup>f</sup>
Adult male	454	0.7	102	0.8	102	2.5	267	4.8
Adult female	595	0.3	786	0.5	106	1.6	211	2.9
Average adult <sup>g</sup>		0.5		0.6		2.1		3.9
Child, age 6 years	8	0.4	16	0.8	4	2.0	5	2.3
Child, age 10 years	10	0.4	40	1.0	29	3.2	43	3.9

<sup>a</sup> Values of inhalation rates for males, females, and children (male and female) presented in this table represent the mean of values reported for each activity level in 1985. (See Appendix Table 5A-7 for a detailed listing of the data from U.S. EPA, 1985.)

<sup>b</sup> n = number of observations at each activity level.

<sup>c</sup> Includes watching television, reading, and sleeping.

<sup>d</sup> Includes most domestic work, attending to personal needs and care, hobbies, and conducting minor indoor repairs and home improvements.

<sup>e</sup> Includes heavy indoor cleanup, performance of major indoor repairs and alterations, and climbing stairs.

<sup>f</sup> Includes vigorous physical exercise and climbing stairs carrying a load.

<sup>g</sup> Derived by taking the mean of the adult male and adult female values for each activity level.

Source: Adapted from U.S. EPA, 1985.

Table 5-17. Activity Pattern Data Aggregated for Three Microenvironments by Activity Level for all Age Groups

Microenvironment	Activity Level	Average Hours Per Day in Each Microenvironment at Each Activity Level
Indoors	Resting	9.82
	Light	9.82
	Moderate	0.71
	Heavy	0.098
	TOTAL	20.4
Outdoors	Resting	0.505
	Light	0.505
	Moderate	0.65
	Heavy	0.12
	TOTAL	1.77
In Transportation Vehicle	Resting	0.86
	Light	0.86
	Moderate	0.05
	Heavy	0.0012
	TOTAL	1.77

Source: Adapted from U.S. EPA, 1985.

Table 5-18. Summary of Daily Inhalation Rates Grouped by Age and Activity level

Subject	Daily Inhalation Rate (m <sup>3</sup> /day) <sup>a</sup>				Total Daily IR <sup>b</sup> (m <sup>3</sup> /day)
	Resting	Light	Moderate	Heavy	
Adult Male	7.83	8.95	3.53	1.05	21.4
Adult Female	3.35	5.59	2.26	0.64	11.8
Adult Average <sup>c</sup>	5.60	6.71	2.96	0.85	16
Child (age 6)	4.47	8.95	2.82	0.50	16.74
Child (age 10)	4.47	11.19	4.51	0.85	21.02

<sup>a</sup> Daily inhalation rate was calculated using the following equation:

$$IR = \frac{1}{T} \sum_{i=1}^k IR_i t_i$$

IR<sub>i</sub> = inhalation rate at i<sup>th</sup> activity (Table 5-18)  
t<sub>i</sub> = hours spent per day during i<sup>th</sup> activity (Table 5-19)  
k = number of activity periods  
T = total time of the exposure period (e.g., a day)

<sup>b</sup> Total daily inhalation rate was calculated by summing the specific activity (resting, light, moderate, heavy) daily inhalation rate.

Source: Generated using the data from U.S. EPA (1985) as shown in Tables 5-16 and 5-17.

various controlled levels of exercise; and (2) individual VR and HR relationships were determined in another set of volunteers during supervised exercise sessions (Shamoo et

al., 1990). In the first approach, the training session involved 9 volunteers (3 females and 6 males) from 21 to 37 years old. Initially the subjects were trained on a



treadmill with regularly increasing speeds. VR measurements were recorded during the last minute of the 3-minute interval at each speed. VR was reported to the subjects as low (1.4 m<sup>3</sup>/hr), medium (1.5-2.3 m<sup>3</sup>/hr), heavy (2.4-3.8 m<sup>3</sup>/hr), and very heavy (3.8<sup>3</sup> m<sup>3</sup>/hr or higher) (Shamoo et al., 1990).

Following the initial test, treadmill training sessions were conducted on a different day in which 7 different speeds were presented, each for 3 minutes in arbitrary order. VR was measured and the subjects were given feedback with the four ventilation ranges provided previously. After resting, a treadmill testing session was conducted in which seven speeds were presented in different arbitrary order from the training session. VR was measured and each subject estimated their own ventilation level at each speed. The correct level was then revealed to each subject after his/her own estimate. Subsequently, two 3-hour outdoor supervised exercise sessions were conducted in the summer on two consecutive days. Each hour consisted of 15 minutes each of rest, slow walking, jogging, and fast walking. The subjects' ventilation level and VR were recorded; however, no feedback was given to the subjects. Electrocardiograms were recorded via direct connection or telemetry and HR was measured concurrently with ventilation measurement for all treadmill sessions.

The second approach consisted of two protocol phases (indoor/outdoor exercise sessions and field testing). Twenty outdoor adult workers between 19-50 years old were recruited. Indoor and outdoor supervised exercises similar to the protocols in the first approach were conducted; however, there were no feedbacks. Also, in this approach, electrocardiograms were recorded and HR was measured concurrently with VR. During the field testing phase, subjects were trained to record their activities during three different 24-hour periods during one week. These periods included their most active working and non-working days. HR was measured quasi-continuously during the 24-hour periods that activities were recorded. The subjects recorded in a diary all changes in physical activity, location, and exercise levels during waking hours. Self-estimated activities in supervised exercises and field studies were categorized as slow (resting, slow walking or equivalent), medium (fast walking or equivalent), and fast (jogging or equivalent).

Inhalation rates were not presented in this study. In the first approach, about 68 percent of all self-estimates were correct for the 9 subjects sampled (Shamoo et al., 1990). Inaccurate self-estimates occurred in the younger male population who were highly physically fit and were

competitive aerobic trainers. This subset of sample population tended to underestimate their own physical activity levels at higher VR ranges. Shamoo et al. (1990) attributed this to a "macho effect." In the second approach, a regression analysis was conducted that related the logarithm of VR to HR. The logarithm of VR correlated better with HR than VR itself (Shamoo et al., 1990).

A limitation associated with this study is that the population sampled is not representative of the general U.S. population. Also, ventilation rates were not presented. Training individuals to estimate their VR may contribute to uncertainty in the results because the estimates are subjective. Another limitation is that calibration data were not obtained at extreme conditions; therefore, the VR/HR relationship obtained may be biased. An additional limitation is that training subjects may be too labor-intensive for widespread use in exposure assessment studies. An advantage of this study is that HR recordings are useful in predicting ventilation rates which in turn are useful in estimating exposure.

*Shamoo et al. (1991) - Activity Patterns in a Panel of Outdoor Workers Exposed to Oxidant Pollution* - Shamoo et al. (1991) investigated summer activity patterns in 20 adult volunteers with potentially high exposure to ambient oxidant pollution. The selected volunteer subjects were 15 men and 5 women ages 19-50 years from the Los Angeles area. All volunteers worked outdoors at least 10 hours per week. The experimental approach involved two stages: (1) indirect objective estimation of VR from HR measurements; and (2) self estimation of inhalation/ventilation rates recorded by subjects in diaries during their normal activities.

The approach consisted of calibrating the relationship between VR and HR for each test subject in controlled exercise; monitoring by subjects of their own normal activities with diaries and electronic HR recorders; and then relating VR with the activities described in the diaries (Shamoo et al., 1991). Calibration tests were conducted for indoor and outdoor supervised exercises to determine individual relationships between VR and HR. Indoors, each subject was tested on a treadmill at rest and at increasing speeds. HR and VR were measured at the third minute at each 3-minute interval speed. In addition, subjects were tested while walking a 90-meter course in a corridor at 3 self-selected speeds (normal, slower than normal, and faster than normal) for 3 minutes.

Two outdoor testing sessions (one hour each) were conducted for each subject, 7 days apart. Subjects exercised on a 260-meter asphalt course. A session



involved 15 minutes each of rest, slow walking, jogging, and fast walking during the first hour. The sequence was also repeated during the second hour. HR and VR measurements were recorded starting at the 8th minute of each 15-minute segment. Following the calibration tests, a field study was conducted in which subject's self-monitored their activities by filling out activity diary booklets, self-estimated their breathing rates, and their HR. Breathing rates were defined as sleep, slow (slow or normal walking); medium (fast walking); and fast (running) (Shamoo et al., 1991). Changes in location, activity, or breathing rates during three 24-hr periods within a week were recorded. These periods included their most active working and non-working days. Each

subject wore Heart Watches which recorded their HR once per minute during the field study. Ventilation rates were estimated for the following categories: sleep, slow, medium, and fast.

Calibration data were fit to the equation  $\log(\text{VR}) = \text{intercept} + (\text{slope} \times \text{HR})$ , each individual's intercept and slope were determined separately to provide a specific equation that predicts each subject's VR from measured HR (Shamoo et al., 1991). The average measured VRs were 0.48, 0.9, 1.68, and 4.02 m<sup>3</sup>/hr for rest, slow walking or normal walking, fast walking and jogging, respectively (Shamoo et al., 1991). Collectively, the diary recordings showed that sleep occupied about 33 percent of the subject's time; slow activity 59 percent; medium activity 7 percent; and fast activity 1 percent. The diary data covered an average of 69 hours per subject (Shamoo et al., 1991). Table 5-19 presents the distribution pattern of predicted ventilation rates and equivalent ventilation rates (EVR) obtained at the four activity levels. EVR was defined as the VR per square meter of body surface area, and also as a percentage of the subjects average VR over the entire field monitoring period (Shamoo et al., 1991).

Table 5-19. Distribution Pattern of Predicted VR and EVR (equivalent ventilation rate) for 20 Outdoor Workers

Self-Reported Activity Level	N <sup>c</sup>	VR (m <sup>3</sup> /hr) <sup>a</sup>		EVR <sup>b</sup> (m <sup>3</sup> /hr/m <sup>2</sup> body surface)					
		Arithmetic Mean ± SD	Geometric Mean ± SD	Arithmetic Mean ± SD	Geometric Mean ± SD				
Sleep	18,597	0.42 ± 0.16	0.39 ± 0.08	0.23 ± 0.08					
Slow	41,745	0.71 ± 0.4	0.65 ± 0.09	0.38 ± 0.20					
Medium	3,898	0.84 ± 0.47	0.76 ± 0.09	0.48 ± 0.24					
Fast	572	2.63 ± 2.16	1.87 ± 0.14	1.42 ± 1.20					
Percentile Rankings, VR									
		1	5	10	50	90	95	99	99.9
Sleep		0.18	0.18	0.24	0.36	0.66	0.72	0.90	1.20
Slow		0.30	0.36	0.36	0.66	1.08	1.32	1.98	4.38
Medium		0.36	0.42	0.48	0.72	1.32	1.68	2.64	3.84
Fast		0.42	0.54	0.60	1.74	5.70	6.84	9.18	10.26
Percentile Rankings, EVR									
		1	5	10	50	90	95	99	99.9
Sleep		0.12	0.12	0.12	0.24	0.36	0.36	0.48	0.60
Slow		0.18	0.18	0.24	0.36	0.54	0.66	1.08	2.40
Medium		0.18	0.24	0.30	0.42	0.72	0.90	1.38	2.28
Fast		0.24	0.30	0.36	0.90	3.24	3.72	4.86	5.52
<sup>a</sup> Data presented by Shamoo et al. (1991) in liters/minute were converted to m <sup>3</sup> /hr. <sup>b</sup> EVR = VR per square meter of body surface area. <sup>c</sup> Number of minutes with valid appearing heart rate records and corresponding daily records of breathing rate.									
Source: Shamoo et al., 1991									



The overall mean predicted VR was 0.42 m<sup>3</sup>/hr for sleep; 0.71 m<sup>3</sup>/hr for slow activity; 0.84 m<sup>3</sup>/hr for medium activity; and 2.63 m<sup>3</sup>/hr for fast activity.

The mean predicted VR and standard deviation, and the percentage of time spent in each combination of VR, activity type (essential and non-essential), and location (indoor and outdoor) are presented in Table 5-20. Essential activities include income-related work, household chores, child care, study and other school activities, personal care and destination-oriented travel. Non-essential activities include sports and active leisure, passive leisure, some travel, and social or civic activities (Shamoo et al., 1991). Table 5-20 shows that inhalation rates were higher outdoors than indoors at slow, medium, and fast activity levels. Also, inhalation rates were higher for outdoor non-essential activities than for indoor non-essential activity levels at slow, medium, and fast self-reported breathing rates (Table 5-20).

An advantage of this study is that subjective activity diary data can provide exposure modelers with useful rough estimates of VR for groups of generally healthy people. A limitation of this study is that the results obtained show high within-person and between-person variability in VR at each diary-recorded level, indicating that VR estimates from diary reports could potentially be

substantially misleading in individual cases. Another limitation of this study is that elevated HR data of slow activity at the second hour of the exercise session reflect persistent effects of exercise and/or heat stress. Therefore, predictions of VR from the VR/HR relationship may be biased.

*Shamoo et al. (1992) - Effectiveness of Training Subjects to Estimate Their Level of Ventilation* - Shamoo et al. (1992) conducted a study where nine non-sedentary subjects in good health were trained on a treadmill to estimate their own ventilation rates at four activity levels: low, medium, heavy, and very heavy. The purpose of the study was to train the subjects self-estimation of ventilation in the field and assess the effectiveness of the training (Shamoo et al., 1992). The subjects included 3 females and 6 males between 21 to 37 years of age. The tests were conducted in four stages. First, an initial treadmill pretest was conducted indoors at various speeds until the four ventilation levels were experienced by each subject; VR was measured and feedback was given to the subjects. Second, two treadmill training sessions which involved seven 3-minute segments of varying speeds based on initial tests were conducted; VR was measured and feedback was given to the subjects. Another similar session was conducted; however, the subjects estimated

Table 5-20. Distribution Pattern of Inhalation Rate by Location and Activity Type for 20 Outdoor Workers

Location	Activity Type <sup>a</sup>	Self-reported Activity Level	% of Time	Inhalation rate (m <sup>3</sup> /hr) <sup>b</sup> ± SD	% of Avg. <sup>c</sup>
Indoor	Essential	Sleep	28.7	0.42 ± 0.12	69 ± 15
		Slow	29.5	0.72 ± 0.36	106 ± 43
		Medium	2.4	0.72 ± 0.30	129 ± 38
		Fast	0	0	0
Indoor	Non-essential	Slow	20.4	0.66 ± 0.36	98 ± 36
		Medium	0.9	0.78 ± 0.30	120 ± 50
		Fast	0.2	1.86 ± 0.96	278 ± 124
Outdoor	Essential	Slow	11.3	0.78 ± 0.36	117 ± 42
		Medium	1.8	0.84 ± 0.54	130 ± 56
		Fast	0	0	0
Outdoor	Non-essential	Slow	3.2	0.90 ± 0.66	136 ± 90
		Medium	0.8	1.26 ± 0.60	213 ± 91
		Fast	0.7	2.82 ± 2.28	362 ± 275

<sup>a</sup> Essential activities include income-related, work, household chores, child care, study and other school activities, personal care, and destination-oriented travel; Non-essential activities include sports and active leisure, passive leisure, some travel, and social or civic activities.

<sup>b</sup> Data presented by Shamoo et al. (1991) in liters/minute were converted to m<sup>3</sup>/hr.

<sup>c</sup> Statistic was calculated by converting each VR for a given subject to a percentage of her/his overall average.

Source: Adapted from Shamoo et al., (1991).





their own ventilation level during the last 20 seconds of each segment and VR was measured during the last minute of each segment. Immediate feedback was given to the subject's estimate; and the third and fourth stages involved 2 outdoor sessions of 3 hours each. Each hour comprised 15 minutes each of rest, slow walking, jogging, and fast walking. The subjects estimated their own ventilation level at the middle of each segment. The subject's estimate was verified by a respirometer which measured VR in the middle of each 15-minute activity. No feedback was given to the subject. The overall percent correct score obtained for all ventilation levels was 68 percent (Shamoo et al., 1992). Therefore, Shamoo et al. (1992) concluded that this training protocol was effective in training subjects to correctly estimate their minute ventilation levels.

For this handbook, inhalation rates were analyzed from the raw data provided by Shamoo et al. (1992). Table 5-21 presents the mean inhalation rates obtained from this analysis at four ventilation levels in two microenvironments (i.e., indoors and outdoors) for all subjects. The mean inhalation rates for all subjects were 0.93, 1.92, 3.01, 4.80 m<sup>3</sup>/hr for low, medium, heavy, and very heavy activities, respectively.

Table 5-21. Actual Inhalation Rates Measured at Four Ventilation Levels					
Subject	Location	Mean Inhalation Rate <sup>a</sup> (m <sup>3</sup> /hr) <sup>a</sup>			
		Low	Medium	Heavy	Very Heavy
All subjects	Indoor (Treadmill post)	1.23	1.83	3.13	4.13
	Outdoor	0.88	1.96	2.93	4.90
	Total	0.93	1.92	3.01	4.80

<sup>a</sup> Original data were presented in L/min. Conversion to m<sup>3</sup>/hr was obtained as follows:

$$60 \frac{\text{min}}{\text{hr}} \times \frac{\text{m}^3}{1000\text{L}} \times \frac{\text{L}}{\text{min}}$$

Source: Adapted from Shamoo et al., 1992

The population sample size used in this study was small and was not selected to represent the general U.S. population. The training approach employed may not be cost effective because it was labor intensive; therefore, this approach may not be viable in field studies especially for field studies within large sample sizes.

*AIHC (1994) - The Exposure Factors Sourcebook* - AIHC (1994) recommends an average adult inhalation rate of 18 m<sup>3</sup>/day and presents values for children of various ages. These recommendations were derived from data presented in U.S. EPA (1989). The newer study by Layton (1993) was not considered. In addition, the Sourcebook presents probability distributions derived by Brorby and Finley (1993). For each distribution, the @Risk formula is provided for direct use in the @Risk simulation software (Palisade, 1992). The organization of this document makes it very convenient to use in support of Monte Carlo analysis. The reviews of the supporting studies are very brief with little analysis of their strengths and weaknesses. The Sourcebook has been classified as a relevant rather than key study because it is not the primary source for the data used to make recommendations in this document. The Sourcebook is very similar to this document in the sense that it summarizes exposure factor data and recommends values. As such, it is clearly relevant as an alternative information source on inhalation rates as well as other exposure factors.

**5.2.4. Recommendations**

In the Ozone Criteria Document prepared by the U.S. EPA Office of Environmental Criteria and Assessment, the EPA identified the collapsed range of activities and its corresponding VR as follows: light exercise (V<sub>E</sub> < 23 L/min or 1.4 m<sup>3</sup>/hr); moderate/ medium exercise (V<sub>E</sub> = 24-43 L/min or 1.4-2.6 m<sup>3</sup>/hr); heavy exercise (V<sub>E</sub> = 43-63 L/min or 2.6-3.8 m<sup>3</sup>/hr); and very heavy exercise (V<sub>E</sub> > 64 L/min or 3.8 m<sup>3</sup>/hr), (Adams, 1993).

Recent peer reviewed scientific papers and an EPA report comprise the studies that were evaluated in this Chapter. These studies were conducted in the United States among both men and women of different age groups. All are widely available. The confidence ratings in the inhalation rate recommendations are shown in Table 5-22.

Each study focused on ventilation rates and factors that may affect them. Studies were conducted among randomly selected volunteers. Efforts were made to include men, women, different age groups, and different kinds of activities. Measurement methods are indirect, but reproducible. Methods are well described (except for questionnaires) and experimental error is well



Table 5-22. Confidence in Inhalation Rate Recommendations

Considerations	Rationale	Rating
<b>Study Elements</b>		
• Peer Review	Studies are from peer reviewed journal articles and an EPA peer reviewed report.	High
• Accessibility	Studies in journals have wide circulation. EPA reports are available from the National Technical Information Service.	High
• Reproducibility	Information on questionnaires and interviews were not provided.	Medium
• Focus on factor of interest	Studies focused on ventilation rates and factors influencing them.	High
• Data pertinent to U.S.	Studies conducted in the U.S.	High
• Primary data	Both data collection and re-analysis of existing data occurred.	Medium
• Currency	Recent studies were evaluated.	High
• Adequacy of data collection period	Effort was made to collect data over time.	High
• Validity of approach	Measurements were made by indirect methods.	Medium
• Representativeness of the population	An effort has been made to consider age and gender, but not systematically.	Medium
• Characterization of variability	An effort has been made to address age and gender, but not systematically.	High
• Lack of bias in study design	Subjects were selected randomly from volunteers and measured in the same way.	High
• Measurement error	Measurement error is well documented by statistics, but procedures measure factor indirectly.	Medium
<b>Other Elements</b>		
• Number of studies	Five key studies and six relevant studies were evaluated.	
• Agreement between researchers	There is general agreement among researchers using different experimental methods.	High
<b>Overall Rating</b>	Several studies exist that attempt to estimate inhalation rates according to age, gender and activity.	High

documented. There is general agreement with these estimates among researchers.

The recommended inhalation rates for adults, children, and outdoor workers/athletes are based on the key studies described in this chapter (Table 5-23). Different survey designs and populations were utilized in the studies described in this Chapter. A summary of these designs, data generated, and their limitations/advantages are presented in Table 5-24. Excluding the study by Layton (1993), the population surveyed in all of the key studies described in this report were limited to the Los Angeles area. This regional population may not represent the general U.S. population and may result in biases. However, based on other aspects of the study design, these studies were selected as the basis for recommended inhalation rates.

The selection of inhalation rates to be used for exposure assessments depends on the age of the exposed population and the specific activity levels of this population during various exposure scenarios. The recommended values for adults, children (including infants), and outdoor workers/athletes for use in various exposure scenarios are discussed below. These rates were calculated by averaging the inhalation rates for each activity level from the various key studies (see Table 5-25).

*Adults (19-65+ yrs)* - Adults in this recommendation include young to middle age adults (19-64

yrs), and older adults (65+ yrs). The daily average inhalation rates for long term exposure for adults are: 11.3 m<sup>3</sup>/day for women and 15.2 m<sup>3</sup>/day for men. These values are averages of the inhalation rates provided for males and females in each of the three approaches of Layton (1993) (Tables 5-11 through 5-14). An upper percentile is not recommended. Additional research and analysis of activity pattern data and dietary data in the future is necessary to attempt to calculate upper percentiles.

The recommended value for the general population average inhalation rate, 11.3 m<sup>3</sup>/day for women and 15.2 m<sup>3</sup>/day for men, is different than the 20 m<sup>3</sup>/day which has commonly been assumed in past EPA risk assessments. In addition, recommendations are presented for various ages and special populations (athletes, outdoor workers) which also differ from 20 m<sup>3</sup>/day. Assessors are encouraged to use values which most accurately reflect the exposed population.

For exposure scenarios where the distribution of activity patterns is known, the following results, calculated from the studies referenced are shown in Table 5-25. Based on these key studies, the following recommendations are made: for short term exposures in



**Table 5-23. Summary of Recommended Values for Inhalation**

Population	Mean	Upper Percentile
<b>Long-term Exposures</b>		
<b>Infants</b>		
<1 year	4.5 m <sup>3</sup> /day	---
<b>Children</b>		
1-2 years	6.8 m <sup>3</sup> /day	---
3-5 years	8.3 m <sup>3</sup> /day	---
6-8 years	10 m <sup>3</sup> /day	---
9-11 years		
males	14 m <sup>3</sup> /day	---
females	13 m <sup>3</sup> /day	---
12-14 years		
males	15 m <sup>3</sup> /day	---
females	12 m <sup>3</sup> /day	---
15-18 years		
males	17 m <sup>3</sup> /day	---
females	12 m <sup>3</sup> /day	---
<b>Adults (19-65+ yrs)</b>		
females	11.3 m <sup>3</sup> /day	---
males	15.2 m <sup>3</sup> /day	---
<b>Short-term Exposures</b>		
<b>Adults</b>		
Rest	0.4 m <sup>3</sup> /hr	---
Sedentary Activities	0.5 m <sup>3</sup> /hr	---
Light Activities	1.0 m <sup>3</sup> /hr	---
Moderate Activities	1.6 m <sup>3</sup> /hr	---
Heavy Activities	3.2 m <sup>3</sup> /hr	---
<b>Children</b>		
Rest	0.3 m <sup>3</sup> /hr	---
Sedentary Activities	0.4 m <sup>3</sup> /hr	---
Light Activities	1.0 m <sup>3</sup> /hr	---
Moderate Activities	1.2 m <sup>3</sup> /hr	---
Heavy Activities	1.9 m <sup>3</sup> /hr	---
<b>Outdoor Workers</b>		
Hourly Average	1.3 m <sup>3</sup> /hr	3.3 m <sup>3</sup> /hr
Slow Activities	1.1 m <sup>3</sup> /hr	
Moderate Activities	1.5 m <sup>3</sup> /hr	
Heavy Activities	2.5 m <sup>3</sup> /hr	

Note: See Tables 5-25, 5-26, and 5-27 for reference studies.

for long-term dose assessments, are based on the first approach of Layton (1993) (Table 5-11) and are summarized in Table 5-26.

Based on the key study results (i.e., Layton, 1993), the recommended daily inhalation rate for infants (children less than 1 yr), during long-term dose assessments is 4.5 m<sup>3</sup>/day. For children 1-2 years old, 3-5 years old, and 6-8 years old, the recommended daily inhalation rates are 6.8 m<sup>3</sup>/day, 8.3 m<sup>3</sup>/day, and 10 m<sup>3</sup>/day, respectively. Recommended values for children aged 9-11 years are 14 m<sup>3</sup>/day for males and 13 m<sup>3</sup>/day for females. For children aged 12-14 years and 15-18 years, the recommended values are shown in Table 5-23.

For short-term exposures for children aged 18 years and under, in which activity patterns are known, the data are summarized in Table 5-27. For short term exposures, the recommended average hourly inhalation rates are based on these key studies. They are averaged over each activity held as follows: 0.3 m<sup>3</sup>/hr during rest; 0.4 m<sup>3</sup>/hr for sedentary activities; 1.0 m<sup>3</sup>/hr for light activities; 1.6 m<sup>3</sup>/hr for moderate activities; and 3.2 m<sup>3</sup>/hr for heavy activities. The recommended short-term exposure data also include infants (less than 1 yr). These values represent averages of the activity level data from key studies (Table 5-27).

**Outdoor Worker** - Inhalation rate data for outdoor workers/athlete are limited. However, based on the key studies (Linn et al., 1992 and 1993), the recommended average hourly inhalation rate for outdoor workers is 1.3 m<sup>3</sup>/hr and the upper-percentile rate is 3.3 m<sup>3</sup>/hr (see Tables 5-5 and 5-8). This is calculated as the weighted mean of the 99th percentile values reported for the individuals on Panels 1 and 7 in Tables 5-5 and the 19 subjects in Table 5-8. The recommended average inhalation rates for outdoor workers based on the activity levels categorized as slow (light activities), medium (moderate activities), and fast (heavy activities) are 1.1 m<sup>3</sup>/hr, 1.5 m<sup>3</sup>/hr, and 2.5 m<sup>3</sup>/hr, respectively. These values are based on the data from Linn et al. (1992 and 1993) and are the weighted mean of the values for the individuals on Panels 1 and 7 in Table 5-5 and the 19 outdoor workers in Table 5-9. Inhalation rates may be higher among outdoor workers/athletes because levels of activity outdoors may be higher. Therefore, this subpopulation group may be more susceptible to air pollutants and are considered a "high-risk" subgroup (Shamoo et al., 1991; Linn et al., 1992).

which distribution of activity patterns are specified, the recommended average rates are 0.4 m<sup>3</sup>/hr during rest; 0.5 m<sup>3</sup>/hr for sedentary activities; 1.0 m<sup>3</sup>/hr for light activities; 1.6 m<sup>3</sup>/hr for moderate activities; and 3.2 m<sup>3</sup>/hr for heavy activities.

**Children (18 yrs old or less including infants)** - For the purpose of this recommendation, children are defined as males and females between the ages of 1-18 years old, while infants are individuals less than 1 year old. The inhalation rates for children are presented below according to different exposure scenarios. The daily inhalation rates



Table 5-24. Summary of Inhalation Rate Studies

Study	Population Surveyed	Survey Time Period	Data Generated	Limitations/Advantages
<b>KEY INHALATION RATE STUDIES</b>				
Adams, 1993	n=160, ages 6-77; n = 40, ages 3-12.	Three 25 min phases of resting protocol in the lab 6 mins of active protocols in the lab. 30 min phases of field protocols repeated once.	Mean values of IR for adult males and females and children by their activity levels.	HR correlated poorly with IR.
Layton, 1993	NFCS survey: n=30,000; NHANES survey: n=20,000 Time Activity survey: n=2,126		Daily IRs; IRs at 5 activity levels; and IR for short-term exposures at 5 activity levels.	Reported food biases in the dietary surveys employed; time activity survey was based on recall.
Linn et al., 1992	Panel 1 - 20 healthy outdoor workers, ages 19-50; Panel 2 - 17 healthy elementary school students, ages 10-12; Panel 3 - 19 healthy high school students, ages 13-17; Panel 4 - 49 adult asthmatics, ages 18-50; Panel 5 - 24 adult asthmatics, ages 19-46; Panel 6 - 13 young asthmatics, ages 11-16; Panel 7 - 7 construction workers, ages 26-34.	Late spring and early autumn. 3 diary days. Construction workers' diary day.	Mean and upper estimates of IR; Mean IR at 3 activity levels.	Small sample size; Calibration data not obtained over full HR range; activities based on short-term diary data.
Linn et al., 1993	n=19 construction workers.	(Mid-July-early November, 1991) Diary recordings before work, during work and break times	Distribution patterns of hourly IR by activity level.	Small sample population size; breathing rates subjective in nature; activities based on short-term diary data.
Spier et al., 1992	n=36 students, ages 10-17.	(Late September - October) Involved 3 consecutive days of diary recording	Distribution patterns of hourly IR by activity levels and location	Activities based on short-term diary data; self-estimated breathing rate by younger population was biased; small sample population size.
<b>RELEVANT INHALATION RATE STUDIES</b>				
ICRP, 1974	Based on data from other references	--	Reference daily IR for adult females, adult males, children (10 yrs), and infant (1 yr)	Validity and accuracy of data set employed not defined; IR was estimated not measured.
Shamoo et al., 1990	n=9 volunteer workers ages 21-37, n=20 outdoor workers, 19-50 years old.	Involved 3-min indoor session/two 3-hr outdoor session at 4 activity levels	No IR data presented.	No useful data were presented for dose assessments studies.
Shamoo et al., 1991	n=20 outdoor workers, ages 19-50	Diary recordings of three 24-hr. periods within a week.	Distribution patterns of IR and EVR by activity levels and location.	Small sample size; short-term diary data.
Shamoo et al., 1992	n=9 non-sedentary subjects, ages 21-37.	3-min. intervals of indoor exercises/two 3-hr outdoor exercise sessions at 4 activity levels.	Actual measured ventilation rates presented.	Small sample size; training approach may not be cost-effective; VR obtained for outdoor workers which are sensitive subpopulation.
U.S. EPA, 1985	Based on data from several literature sources	--	Estimated IR for adult males, adult females and children (ages 6 and 10) by various activity levels.	Validity and accuracy of data set employed not defined; IR was estimated not measured.
Note: IR = inhalation rate; HR = heart rate; EVR = equivalent ventilation rate.				



Table 5-25. Summary of Adult Inhalation Rates for Short-Term Exposure Studies					
Arithmetic Mean (m <sup>3</sup> /hr)					
Activity Level					
Rest	Sedentary	Light	Moderate	High	Reference
0.5	0.5	1.4	2.4	3.3	Adams, 1993 (Lab protocols)
--	0.6	1.2	1.8	--	Adams, 1993 (Field protocols)
0.4	0.4	0.7	1.4	3.6	Layton, 1993 (Short-term exposure)
0.4	--	0.6	1.5	3.0	Layton, 1993 (3rd approach)
--	--	1.0	1.6	3.0	Linn et al., 1992

Table 5-26. Summary of Children's (18 years old or less) Inhalation Rates for Long-Term Exposure Studies <sup>a</sup>					
Arithmetic Mean (m <sup>3</sup> /day)					
Age	Males	Females	Males and Females	Reference	
less than 1 yr	--	--	4.5	Layton, 1993	
1-2 years	--	--	6.8	Layton, 1993	
3-5 years	--	--	8.3	Layton, 1993	
6-8 years	--	--	10	Layton, 1993	
9-11 years	14	13	--	Layton, 1993	
12-14 years	15	12	--	Layton, 1993	
15-18 years	17	12	--	Layton, 1993	

<sup>a</sup> Layton, 1993 1st approach.

Table 5-27. Summary of Children's Inhalation Rates for Short-Term Exposure Studies					
Arithmetic Mean (m <sup>3</sup> /hr)					
Activity Level					
Rest	Sedentary	Light	Moderate	High	Reference
0.4	0.4	0.8	--	--	Adams, 1993 (Lab protocols)
--	--	--	0.9	--	Adams, 1993 (Field protocols)
0.2	0.3	0.5	1.0	2.5	Layton, 1993 (Short-term data)
--	--	1.8	2.0	2.2	Spier et al., 1992 (10-12 yrs)
--	--	0.8	1.0	11	Linn et al., 1992 (10-12 yrs)



**5.3. REFERENCES FOR CHAPTER 5**

- Adams, W.C. (1993) Measurement of breathing rate and volume in routinely performed daily activities, Final Report. California Air Resources Board (CARB) Contract No. A033-205. June 1993. 185 pgs.
- American Industrial Health Council (AIHC) (1994) Exposure factors sourcebook. AIHC, Washington, DC.
- Basiotis, P.P.; Thomas, R.G.; Kelsay, J.L.; Mertz, W. (1989) Sources of variation in energy intake by men and women as determined from one year's daily dietary records. *Am. J. Clin. Nutr.* 50:448-453.
- Benjamin, G.S. (1988) "The lungs." In: *Fundamentals of Industrial Hygiene*, Third Edition, Plog, B.A., ed. Chicago, IL: National Safety Council, p. 31-45.
- Brorby, G.; Finley, B. (1993) Standard probability density functions for routine use in environmental health risk assessment. Presented at the Society of Risk Analysis Meeting, December 1993, Savannah, GA.
- ICRP. (1981) International Commission on Radiological Protection. Report of the task group on reference man. New York: Pergamon Press.
- Layton, D.W. (1993) Metabolically consistent breathing rates for use in dose assessments. *Health Physics* 64(1):23-36.
- Linn, W.S.; Shamoo, D.A.; Hackney, J.D. (1992) Documentation of activity patterns in "high-risk" groups exposed to ozone in the Los Angeles area. In: *Proceedings of the Second EPA/AWMA Conference on Tropospheric Ozone*, Atlanta, Nov. 1991. pp. 701-712. Air and Waste Management Assoc., Pittsburgh, PA.
- Linn, W.S.; Spier, C.E.; Hackney, J.D. (1993) Activity patterns in ozone-exposed construction workers. *J. Occ. Med. Tox.* 2(1):1-14.
- Menzel, D.B.; Amdur, M.O. (1986) Toxic responses of the respiratory system. In: *Klaassen, C.; Amdur, M.O.; Doull, J., eds. Toxicology, The Basic Science of Poisons*. 3rd edition. New York: MacMillan Publishing Company.
- Najjar, M.F.; Rowland, M. (1987) Anthropometric reference data and prevalence of overweight: United States. 1976-80. Hyattsville, MD: National Center for Health Statistics. U.S. Department of Health and Human Services: DHHS Publication No. (PHS)87-1688.
- Palisade. (1992) @Risk User Guide. Newfield, NY: Palisade Corporation.
- Sallis, J.F.; Haskell, W.L.; Wood, P.D.; Fortmann, S.P.; Rogers, T.; Blair, S.N.; Paffenbarger, Jr., R.S. (1985) Physical activity assessment methodology in the Five-City project. *Am. J. Epidemiol.* 121:91-106.
- Shamoo, D.A.; Trim, S.C.; Little, D.E.; Linn, W.S.; Hackney, J.D. (1990) Improved quantitation of air pollution dose rates by improved estimation of ventilation rate. In: *Total Exposure Assessment Methodology: A New Horizon*, pp. 553-564. Air and Waste Management Assoc., Pittsburgh, PA.
- Shamoo, D.A.; Johnson, T.R.; Trim, S.C.; Little, D.E.; Linn, W.S.; Hackney, J.D. (1991) Activity patterns in a panel of outdoor workers exposed to oxidant pollution. *J. Expos. Anal. Environ. Epidemiol.* 1(4):423-438.
- Shamoo, D.A.; Trim, S.C.; Little, D.E.; Whynot, J.D.; Linn, W.S. (1992) Effectiveness of training subjects to estimate their level of ventilation. *J. Occ. Med. Tox.* 1(1):55-62.
- Spier, C.E.; Little, D.E.; Trim, S.C.; Johnson, T.R.; Linn, W.S.; Hackney, J.D. (1992) Activity patterns in elementary and high school students exposed to oxidant pollution. *J. Exp. Anal. Environ. Epid.* 2(3):277-293.
- U.S. EPA. (1985) Development of statistical distributions or ranges of standard factors used in exposure assessments. Washington, DC: Office of Health and Environmental Assessment; EPA report No. EPA 600/8-85-010. Available from: NTIS, Springfield, VA; PB85-242667.
- U.S. EPA. (1989) Exposure factors handbook. Washington, DC: Office of Research and Development, Office of Health and Environmental Assessment. EPA/600/18-89/043.
- U.S. EPA. (1992) Guidelines for exposure assessment. Washington, DC: Office of Research and Development, Office of Health and Environmental Assessments. EPA/600/Z-92/001.
- U.S. EPA. (1994) Methods for derivation of inhalation reference concentrations and application of inhalation dosimetry. Washington, DC: Office of Health and Environmental Assessment. EPA/600/8-90/066F.



**APPENDIX 5A**

**VENTILATION DATA**



Appendix 5A

Table 5A-1. Mean Minute Ventilation ( $V_E$ , L/min) by Group and Activity for Laboratory Protocols					
Activity		Young Children <sup>a</sup>	Children	Adult Females	Adult Males
Lying		6.19	7.51	7.12	8.93
Sitting		6.48	7.28	7.72	9.30
Standing		6.76	8.49	8.36	10.65
Walking	1.5 mph	10.25	DNP	DNP	DNP
	1.875 mph	10.53	DNP	DNP	DNP
	2.0 mph	DNP	14.13	DNP	DNP
	2.25 mph	11.68	DNP	DNP	DNP
	2.5 mph	DNP	15.58	20.32	24.13
	3.0 mph	DNP	17.79	24.20	DNP
	3.3 mph	DNP	DNP	DNP	27.90
	4.0 mph	DNP	DNP	DNP	36.53
Running	3.5 mph	DNP	26.77	DNP	DNP
	4.0 mph	DNP	31.35	46.03 <sup>b</sup>	DNP
	4.5 mph	DNP	37.22	47.86 <sup>b</sup>	57.30
	5.0 mph	DNP	DNP	50.78 <sup>b</sup>	58.45
	6.0 mph	DNP	DNP	DNP	65.66 <sup>b</sup>

<sup>a</sup> Young Children, male and female 3-5.9 yr olds; Children, male and female 6-12.9 yr olds; Adult Females, adolescent, young to middle-aged, and older adult females; Adult Males, adolescent, young to middle-aged, and older adult males; DNP, group did not perform this protocol or N was too small for appropriate mean comparisons

<sup>b</sup> Older adults not included in the mean value since they did not perform running protocol at particular speeds.

Source: Adams, 1993.

Table 5A-2. Mean Minute Ventilation ( $V_E$ , L/min) by Group and Activity for Field Protocols					
Activity		Young Children <sup>a</sup>	Children	Adult Females	Adult Males
Play		11.31	17.89	DNP	DNP
Car Driving		DNP	DNP	8.95	10.79
Car Riding		DNP	DNP	8.19	9.83
Yardwork		DNP	DNP	19.23 <sup>c</sup>	26.07 <sup>b</sup> /31.89 <sup>c</sup>
Housework		DNP	DNP	17.38	DNP
Car Maintenance		DNP	DNP	DNP	23.21 <sup>d</sup>
Mowing		DNP	DNP	DNP	36.55 <sup>e</sup>
Woodworking		DNP	DNP	DNP	24.42 <sup>e</sup>

<sup>a</sup> Young Children, male and female 3-5.9 yr olds; Children, male and female 6-12.9 yr olds; Adult Females, adolescent, young to middle-aged, and older adult females; Adult Males, adolescent, young to middle-aged, and older adult males; DNP, group did not perform this protocol or N was too small for appropriate mean comparisons;

<sup>b</sup> Mean value for young to middle-aged adults only

<sup>c</sup> Mean value for older adults only

<sup>d</sup> Older adults not included in the mean value since they did not perform this activity.

<sup>e</sup> Adolescents not included in mean value since they did not perform this activity

Source: Adams, 1993.





Table 5A-3. Characteristics of Individual Subjects: Anthropometric Data, Job Categories, Calibration Results

Subj. #	Age (years)	Ht. (in.)	Wt. (lb.)	Ethnic Group <sup>a</sup>	Job <sup>b</sup>	Site <sup>c</sup>	Calibration	
							HR Range <sup>d</sup>	r <sup>2e</sup>
1761	26	71	180	Wht	GCW	Ofc	69-108	.91
1763	29	63	135	Asn	GCW	Ofc	80-112	.95
1764	32	71	165	Blk	Car	Ofc	56-87	.95
1765	30	73	145	Wht	GCW	Ofc	66-126	.97
1766	31	67	170	His	Car	Ofc	75-112	.89
1767	34	74	220	Wht	Car	Ofc	59-114	.98
1768	32	69	155	Blk	GCW	Ofc	62-152	.95
1769	32	77	230	Wht	Car	Hosp	69-132	.99
1770	26	70	180	Wht	Car	Hosp	63-106	.89
1771	39	66	150	Wht	Car	Hosp	88-118	.91
1772	32	71	260	Wht	Car	Hosp	83-130	.97
1773	39	69	170	Wht	Irn	Hosp	77-128	.95
1774	23	68	150	His	Car	Hosp	68-139	.98
1775	42	67	150	Wht	Irn	Hosp	76-118	.88
1776	29	70	180	His	Car	Hosp	68-152	.99
1778	35	76	220	Ind	Car	Hosp	70-129	.94
1779	40	70	175	Wht	Car	Hosp	72-140	.99
1780	37	75	242	His	Irn	Hosp	68-120	.98
1781	38	65	165	His	Lab	Hosp	66-121	.89
Mean	33	70	181				70-123	.94
SD	5	4	36				8-16	.04

<sup>a</sup> Abbreviations are interpreted as follows. Ethnic Group: Asn = Asian-Pacific, Blk = Black, His = Hispanic, Ind = American Indian, Wht = White

<sup>b</sup> Job: Car = carpenter, GCW = general construction worker, Irn = ironworker, Lab = laborer

<sup>c</sup> Site: Hosp = hospital building, Ofc = medical office complex. Calibration data

<sup>d</sup> HR range = range of heart rates in calibration study

<sup>e</sup> r<sup>2</sup> = coefficient of determination (proportion of ventilation rate variability explainable by heart rate variability under calibration-study conditions, using quadratic prediction equation).

Source: Linn et al., 1993.

Table 5A-4. Statistics of the Age/Gender Cohorts Used to Develop Regression Equations for Predicting Basal Metabolic Rates (BMR)

Gender/Age (y)	BMR			Body Weight		BMR Equation <sup>c</sup>	r <sup>d</sup>
	MJ d <sup>-1</sup>	±SD	CV <sup>a</sup>	(kg)	N <sup>b</sup>		
<b>Males</b>							
Under 3	1.51	0.918	0.61	6.6	162	0.249 bw - 0.127	0.95
3 to < 10	4.14	0.498	0.12	21	338	0.095 bw + 2.110	0.83
10 to < 18	5.86	1.171	0.20	42	734	0.074 bw + 2.754	0.93
18 to < 30	6.87	0.843	0.12	63	2879	0.063 bw + 2.896	0.65
30 to < 60	6.75	0.872	0.13	64	646	0.048 bw + 3.653	0.6
60 +	5.59	0.928	0.17	62	50	0.049 bw + 2.459	0.71
<b>Females</b>							
Under 3	1.54	0.915	0.59	6.9	137	0.244 bw - 0.130	0.96
3 to < 10	3.85	0.493	0.13	21	413	0.085 bw + 2.033	0.81
10 to < 18	5.04	0.780	0.15	38	575	0.056 bw + 2.898	0.8
18 to < 30	5.33	0.721	0.14	53	829	0.062 bw + 2.036	0.73
30 to < 60	5.62	0.630	0.11	61	372	0.034 bw + 3.538	0.68
60 +	4.85	0.605	0.12	56	38	0.038 bw + 2.755	0.68

<sup>a</sup> Coefficient of variation (SD/mean)

<sup>b</sup> N = number of subjects

<sup>c</sup> Body weight (bw) in kg

<sup>d</sup> coefficient of correlation

Source: Layton, 1993.

Table 5A-5. Selected Ventilation Values During Different Activity Levels Obtained From Various Literature Sources

Col.	1	2	3			4			5			6		
Line	Subject	W (kg)	Resting			Light Activity			Heavy Work			Maximal Work During Exercise		
			f	VT	V*	f	VT	V*	f	VT	V*	f	VT	V*
	<u>Adult</u>													
1	Man	68.5	12	750	7.4	17	1670	29	21	2030	43			
2	1.7 m <sup>2</sup> SA		12	500	6									
3	30y; 170 cm L		15	500	7.5	16	1250	20						
4	20-33 y	70.4												
5	Woman	54	12	340	4.5	19	860	16	30	880	25	40	3050	111
6	30 y; 160 cm L		15	400	6	20	940	19						
7	20-25 y; 165.8 cm L	60.3										46	2100	90
8	Pregnant (8th mo)		16	650	10									
	<u>Adolescent</u>													
9	male, 14-16 y		16	330	5.2							53	2520	113
10	male, 14-15 y	59.4												
11	female, 14-16 y		15	300	4.5									
12	female, 14-15 y; 164.9 cm L	56										52	1870	88
	<u>Children</u>													
13	10 y; 140 cm L		16	300	4.8	24	600	14						
14	males, 10-11 y	36.5												
15	males, 10-11 y; 140.6 cm L	32.5										58	1330	71
16	females, 4-6 y	20.8										61	1050	61
17	females, 4-6 y; 111.6 cm L	18.4										70	600	40
18	Infant, 1 y		30	48	1.4 <sup>a</sup>							66	520	34
19	Newborn	2.5	34	15	0.5									
20	20 hrs-13 wk	2.5-5.3										68 <sup>b</sup>	51 <sup>a,b</sup>	3.5 <sup>b</sup>
21	9.6 hrs	3.6	25	21	0.5									
22	6.6 days	3.7	29	21	0.6									

W = body weights referable to the dimension quoted in column 1; f = frequency (breaths/min); VT = tidal volume (ml); V\* = minute volume (l/min); SA = surface area; cm L = length/height; y = years of age; wk = week.

<sup>a</sup> Calculated from  $V^* = f \times VT$ .

<sup>b</sup> Crying.

Source: ICRP, 1981.





Table 5A-5. Selected Ventilation Values During Different Activity Levels Obtained From Various Literature Sources

Col.	1	2	3			4			5			6		
Line	Subject	W (kg)	Resting			Light Activity			Heavy Work			Maximal Work During Exercise		
			f	VT	V*	f	VT	V*	f	VT	V*	f	VT	V*
	<u>Adult</u>													
1	Man	68.5	12	750	7.4	17	1670	29	21	2030	43			
2	1.7 m <sup>2</sup> SA		12	500	6									
3	30y; 170 cm L		15	500	7.5	16	1250	20						
4	20-33 y	70.4										40	3050	111
5	Woman	54	12	340	4.5	19	860	16	30	880	25			
6	30 y; 160 cm L		15	400	6	20	940	19						
7	20-25 y; 165.8 cm L	60.3										46	2100	90
8	Pregnant (8th mo)		16	650	10									
	<u>Adolescent</u>													
9	male, 14-16 y		16	330	5.2							53	2520	113
10	male, 14-15 y	59.4												
11	female, 14-16 y		15	300	4.5									
12	female, 14-15 y; 164.9 cm L	56										52	1870	88
	<u>Children</u>													
13	10 y; 140 cm L		16	300	4.8	24	600	14						
14	males, 10-11 y	36.5										58	1330	71
15	males, 10-11 y; 140.6 cm L	32.5										61	1050	61
16	females, 4-6 y	20.8										70	600	40
17	females, 4-6 y; 111.6 cm L	18.4										66	520	34
18	Infant, 1 y		30	48	1.4 <sup>a</sup>									
19	Newborn	2.5	34	15	0.5									
20	20 hrs-13 wk	2.5-5.3										68 <sup>b</sup>	51 <sup>ab</sup>	3.5 <sup>b</sup>
21	9.6 hrs	3.6	25	21	0.5									
22	6.6 days	3.7	29	21	0.6									

W = body weights referable to the dimension quoted in column 1; f = frequency (breaths/min); VT = tidal volume (ml); V\* = minute volume (l/min); SA = surface area; cm L = length/height; y = years of age; wk = week.

<sup>a</sup> Calculated from V\* = f x VT.

<sup>b</sup> Crying.

Source: ICRP, 1981.



Table 5A-6. Estimated Minute Ventilation Associated with Activity Level for Average Male Adult<sup>a</sup>

Level of work	L/min	Representative activities
Light	13	Level walking at 2 mph; washing clothes
Light	19	Level walking at 3 mph; bowling; scrubbing floors
Light	25	Dancing; pushing wheelbarrow with 15-kg load; simple construction; stacking firewood
Moderate	30	Easy cycling; pushing wheelbarrow with 75-kg load; using sledgehammer
Moderate	35	Climbing stairs; playing tennis; digging with spade
Moderate	40	Cycling at 13 mph; walking on snow; digging trenches
Heavy	55	Cross-country skiing; rock climbing; stair climbing
Heavy	63	with load; playing squash or handball; chopping
Very heavy	72	with axe
Very heavy	85	Level running at 10 mph; competitive cycling
Severe	100+	Competitive long distance running; cross-country skiing

<sup>a</sup> Average adult assumed to weigh 70 kg.  
 Source: Adapted from U.S. EPA, 1985



Table 5A-7. Minute Ventilation Ranges by Age, Sex, and Activity Level

		Ventilation ranges (liters/minute)											
Age (years)	Sex	Resting			Light			Moderate			Heavy		
		n	Range	Mean	n	Range	Mean	n	Range	Mean	n	Range	Mean
Infants	M/F	316	0.25 - 2.09	0.84									
2	F		---										
	M		---										
3	F		---										
	M		---										
4	F		---								2	32.0 - 32.5	32.3
	M		---								4	39.3 - 43.3	41.2
5	F		---								3	31.0 - 35.0	32.8
	M		---								3	30.9 - 42.6	37.5
6	F		---								2	35.9 - 38.9	37.4
	M		---								3	35.5 - 43.5	40.3
7	F	8	5.0 - 7.0	6.5	16	5.0 - 32.0	13.9	4	28.0 - 43.0	33.3	3	48.2 - 51.4	49.6
	M		---			---			---		2	44.1 - 55.8	50.0
8	F		---			---			---		4	51.2 - 67.6	57.6
	M		---			---			---		3	59.3 - 62.2	60.7
9	F		---			---			---		27	55.8 - 63.4	50.9
	M		---			---			---		7	59.5 - 75.2	65.7
10	F		---			---			---		21	46.2 - 71.1	60.4
	M	10	5.2 - 8.3	7.1	20	5.2 - 35.0	17.2	9	41.0 - 68.0	53.4	6	63.9 - 74.6	70.5
	F		---			---			---		7	49.7 - 80.9	63.5
	M		---		20	---	20.3	20	---	33.1	9	47.6 - 77.5	65.5
12	F	54	4.1 - 16.1	15.4		---		4	19.6 - 46.3	26.5	31	65.5 - 79.9	71.8
	M	56	7.2 - 16.3	15.4		---		6	18.5 - 46.3	34.1	9	58.1 - 84.7	67.7
13	F	5	7.2 - 15.4	9.9		---		5	18.5 - 46.3	30.3	7	67.6 - 102.6	87.7
	M	16	3.1 - 15.4	8.9	30	3.1 - 24.9	16.4	29	14.4 - 48.4	32.8	38	27.8 - 105.0	57.9
14	F	53	3.1 - 15.6	14.9		---		3	21.6 - 37.1	28.1	5	80.7 - 100.7	88.9
	M	77	3.1 - 27.8	14.2		---		24	24.7 - 55.0	39.7	16	42.2 - 121.0	86.9
15	F	1	---	6.2		---		1	---	26.8	6	68.4 - 97.1	87.1
	M	8	3.1 - 26.8	11.1		---		7	27.8 - 46.3	39.3	6	48.4 - 140.3	110.5
16	F	50	---	15.2		---	---		---		8	73.6 - 119.1	93.9
	M	50	---	15.6		---			---		3	79.6 - 132.2	102.5
17	F		---			---			---		2	91.9 - 95.3	93.6
	M	12	5.8 - 9.0	7.3		---		12	40.0 - 63.0	48.6	3	89.4 - 139.3	107.7
18	F		---			---			---		9	99.7 - 143.0	120.9
	M		---			---			---		211	23.4 - 114.8	47.9
Adults	F	595	4.2 - 11.66	5.7	786	4.2 - 29.4	8.1	106	20.7 - 34.2	26.5	211	23.4 - 114.8	47.9
Adults	M	454	2.3 - 18.8	12.2	102	2.3 - 27.6	13.8	102	14.4 - 78.0	40.9	267	34.6 - 183.4	80.0

n = number of observations  
 Note: Values in liters/minute can be converted to units of m<sup>3</sup>/hour<sup>2</sup> by multiplying by the conversion factor  $\frac{60 \text{ minutes/hour}}{1000 \text{ liters/m}}$

Source: Adapted from U.S. EPA, 1985.



# TABLE OF CONTENTS

	<u>Page No.</u>
6. DERMAL ROUTE .....	1
6.1. EQUATION FOR DERMAL DOSE .....	1
6.2. SURFACE AREA .....	2
6.2.1. Background .....	2
6.2.2. Measurement Techniques .....	2
6.2.3. Key Body Surface Area Studies .....	2
6.2.4. Relevant Surface Area Studies .....	4
6.2.5. Application of Body Surface Area Data .....	4
6.3. SOIL ADHERENCE TO SKIN .....	6
6.3.1. Background .....	6
6.3.2. Key Soil Adherence to Skin Studies .....	6
6.3.3. Relevant Soil Adherence to Skin Studies .....	6
6.4. RECOMMENDATIONS .....	8
6.4.1. Body Surface Area .....	8
6.4.2. Soil Adherence to Skin .....	8
<b>6.5. REFERENCES FOR CHAPTER 6 .....</b>	<b>10</b>
 APPENDIX 6A	
.....	3



**6. DERMAL ROUTE**

Dermal exposure can occur during a variety of activities in different environmental media and microenvironments (U.S. EPA, 1992). These include:

- Water (e.g., bathing, washing, swimming);
- Soil (e.g., outdoor recreation, gardening, construction);
- Sediment (e.g., wading, fishing);
- Liquids (e.g., use of commercial products);
- Vapors/fumes (e.g., use of commercial products); and
- Indoors (e.g., carpets, floors, countertops).

The major factors that must be considered when estimating dermal exposure are: the chemical concentration in contact with the skin, the potential dose, the extent of skin surface area exposed, the duration of exposure, the absorption of the chemical through the skin, the internal dose, and the amount of chemical that can be delivered to a target organ (i.e., biologically effective dose) (see Figure 6-1). A detailed discussion of these factors can be found in Guidelines for Exposure Assessment (U.S. EPA, 1992a).

This chapter focuses on measurements of body surface areas and various factors needed to estimate dermal exposure to chemicals in water and soil. Information concerning dermal exposure to pollutants in indoor environments is limited. Useful information concerning estimates of body surface area can be found in "Development of Statistical Distributions or Ranges of Standard Factors Used in Exposure Assessments" (U.S. EPA, 1985). "Dermal Exposure Assessment: Principles and Applications (U.S. EPA, 1992b), provides detailed information concerning dermal exposure using a stepwise guide in the exposure assessment process.

The available studies have been classified as either key or relevant based on their applicability to exposure assessment needs and are summarized in this chapter. Recommended values are based on the results of the key studies. Relevant studies are presented to provide an added perspective on the state-of-knowledge pertaining to dermal exposure factors. All tables and figures presenting data from these studies are shown at the end of this chapter.

**6.1. EQUATION FOR DERMAL DOSE**

The average daily dose (ADD) is the dose rate averaged over a pathway-specific period of exposure

expressed as a daily dose on a per-unit-body-weight basis. The ADD is used for exposure to chemicals with non-carcinogenic non-chronic effects. For compounds with carcinogenic or chronic effects, the lifetime average daily dose (LADD) is used. The LADD is the dose rate averaged over a lifetime.

For dermal contact with chemicals in soil or water, dermally absorbed average daily dose can be estimated by (U.S. EPA, 1992b):

$$ADD = \frac{DA_{event} \times EV \times ED \times EF \times SA}{BW \times AT} \quad (\text{Eqn. 6-1})$$

where:

- ADD = average daily dose (mg/kg-day);
- DA<sub>event</sub> = absorbed dose per event (mg/cm<sup>2</sup>-event);
- EV = event frequency (events/day);
- ED = exposure duration (years);
- EF = exposure frequency (days/year);
- SA = skin surface area available for contact (cm<sup>2</sup>);
- BW = body weight (kg); and
- AT = averaging time (days) for noncarcinogenic effects, AT = ED and for carcinogenic effects, AT = 70 years or 25,550 days.

This method is to be used to calculate the absorbed dose of a chemical. Total body surface area (SA) is assumed to be exposed for a period of time (ED).

For dermal contact with water, the DA<sub>event</sub> is estimated with consideration for the permeability coefficient from water, the chemical concentration in water, and the event duration. The approach to estimate DA<sub>event</sub> is different for inorganic and organic compounds. The nonsteady-state approach to estimate the dermally absorbed dose from water is recommended as the preferred approach for organics which exhibit octanol-water partitioning (U.S. EPA, 1992b). First, this approach more accurately reflects normal human exposure conditions since the short contact times associated with bathing and swimming generally mean that steady state will not occur. Second, the approach accounts for uptake that can occur after the actual exposure event due to absorption of residual chemical trapped in skin tissue. Use of the nonsteady-state model for organics has implications for selecting permeability coefficient (K<sub>p</sub>) values (U.S. EPA, 1992b). It is recommended that the traditional steady-state approach be applied to inorganics (U.S. EPA, 1992b). Detailed information concerning how to estimate absorbed dose per event (DA<sub>event</sub>) and K<sub>p</sub>





values can be found in Section 5.3.1 of “Dermal Exposure Assessment: Principles and Applications” (U.S. EPA, 1992b).

For dermal contact with contaminated soil, estimation of the  $DA_{event}$  is different from the estimation for dermal contact with chemicals in water. It is based on the concentration of the chemical in soil, the adherence factor of soil to skin, and the absorption fraction. Information for  $DA_{event}$  estimation from soil contact can be found in U.S. EPA (1992b), Section 6.4.

The apparent simplicity of the absorption fraction (percent absorbed) makes this approach appealing. However, it is not practical to apply it to water contact scenarios, such as swimming, because of the difficulty in estimating the total material contacted (U.S. EPA, 1992b). It is assumed that there is essentially an infinite amount of material available, and that the chemical will be replaced continuously, thereby increasing the amount of material (containing the chemical) available by some large unknown amount. Therefore, the permeability coefficient-based approach is recommended over the absorption fraction approach for determining the dermally absorbed dose of chemicals in aqueous media.

Before the absorption fraction approach can be used in soil contact scenarios, the contaminant concentration in soil must be established. Not all of the chemical in a layer of dirt applied to skin may be bioavailable, nor is it assumed to be an internal dose. Because of the lack of  $K_p$  data for compounds bound to soil, and reduced uncertainty in defining an applied dose, the absorption fraction-based approach is suggested for determining the internal dose of chemicals in soil. More detailed explanation of the equations, assumptions, and approaches can be found in “Dermal Exposure Assessment: Principles and Applications” (U.S. EPA, 1992b).

## 6.2. SURFACE AREA

### 6.2.1. Background

The total surface area of skin exposed to a contaminant must be determined using measurement or estimation techniques before conducting a dermal exposure assessment. Depending on the exposure scenario, estimation of the surface area for the total body or a specific body part can be used to calculate the contact rate for the pollutant. This section presents estimates for total body surface area and for body parts and presents information on the application of body surface area data.

### 6.2.2. Measurement Techniques

Coating, triangulation, and surface integration are direct measurement techniques that have been used to measure total body surface area and the surface area of specific body parts. Consideration has been given for differences due to age, gender, and race. The results of the various techniques have been summarized in “Development of Statistical Distributions or Ranges of Standard Factors Used in Exposure Assessments” (U.S. EPA, 1985). The coating method consists of coating either the whole body or specific body regions with a substance of known or measured area. Triangulation consists of marking the area of the body into geometric figures, then calculating the figure areas from their linear dimensions. Surface integration is performed by using a planimeter and adding the areas.

The triangulation measurement technique developed by Boyd (1935) has been found to be highly reliable. It estimates the surface area of the body using geometric approximations that assume parts of the body resemble geometric solids (Boyd, 1935). More recently, Popendorf and Leffingwell (1976), and Haycock et al. (1978) have developed similar geometric methods that assume body parts correspond to geometric solids, such as the sphere and cylinder. A linear method proposed by DuBois and DuBois (1916) is based on the principle that the surface areas of the parts of the body are proportional, rather than equal to the surface area of the solids they resemble.

In addition to direct measurement techniques, several formulae have been proposed to estimate body surface area from measurements of other major body dimensions (i.e., height and weight) (U.S. EPA, 1985). Generally, the formulae are based on the principles that body density and shape are roughly the same and that the relationship of surface area to any dimension may be represented by the curve of central tendency of their plotted values or by the algebraic expression for the curve. A discussion and comparison of formulae to determine total body surface area are presented in Appendix 6A.

### 6.2.3. Key Body Surface Area Studies

U.S. EPA (1985) - *Development of Statistical Distributions or Ranges of Standard Factors Used in Exposure Assessments* - U.S. EPA (1985) analyzed the direct surface area measurement data of Gehan and George (1970) using the Statistical Processing System (SPS) software package of Buhyoff et al. (1982). Gehan and George (1970) selected 401 measurements made by



---

**Chapter 6 - Dermal**

---

Boyd (1935) that were complete for surface area, height, weight, and age for their analysis. Boyd (1935) had reported surface area estimates for 1,114 individuals using coating, triangulation, or surface integration methods (U.S. EPA, 1985).

U.S. EPA (1985) used SPS to generate equations to calculate surface area as a function of height and weight. These equations were then used to calculate body surface area distributions of the U.S. population using the height and weight data obtained from the National Health and Nutrition Examination Survey (NHANES) II and the computer program QNTLS of Rochon and Kalsbeek (1983).

The equation proposed by Gehan and George (1970) was determined by U.S. EPA (1985) to be the best choice for estimating total body surface area. However, the paper by Gehan and George (1970) gave insufficient information to estimate the standard error about the regression. Therefore, U.S. EPA (1985) used the 401 direct measurements of children and adults and reanalyzed the data using the formula of Dubois and Dubois (1916) and SPS to obtain the standard error (U.S. EPA, 1985).

Regression equations were developed for specific body parts using the Dubois and Dubois (1916) formula and using the surface area of various body parts provided by Boyd (1935) and Van Graan (1969) in conjunction with SPS. Regression equations for adults were developed for the head, trunk (including the neck), upper extremities (arms and hands, upper arms, and forearms) and lower extremities (legs and feet, thighs, and lower legs) (U.S. EPA, 1985). Table 6-1 presents a summary of the equation parameters developed by U.S. EPA (1985) for calculating surface area of adult body parts. Equations to estimate the body part surface area of children were not developed because of insufficient data.

Percentile estimates of total surface area and surface area of body parts developed by U.S. EPA (1985) using the regression equations and NHANES II height and weight data are presented in Tables 6-2 and 6-3 for adult males and adult females, respectively. The calculated mean surface areas of body parts for men and women are presented in Table 6-4. The standard deviation, the minimum value, and the maximum value for each body part are included. The median total body surface area for men and women and the corresponding standard errors about the regressions are also given. It has been assumed that errors associated with height and weight are negligible (U.S. EPA, 1985). The data in Table 6-5

present the percentage of total body surface by body part for men and women.

Percentile estimates for total surface area of male and female children presented in Tables 6-6 and 6-7 were calculated using the total surface area regression equation, NHANES II height and weight data, and using QNTLS. Estimates are not included for children younger than 2 years old because NHANES height data are not available for this age group. For children, the error associated with height and weight cannot be assumed to be zero because of their relatively small sizes. Therefore, the standard errors of the percentile estimates cannot be estimated, since it cannot be assumed that the errors associated with the exogenous variables (height and weight) are independent of that associated with the model; there are insufficient data to determine the relationship between these errors.

Measurements of the surface area of children's body parts are summarized as a percentage of total surface area in Table 6-8. Because of the small sample size, the data cannot be assumed to represent the average percentage of surface area by body part for all children. Note that the percent of total body surface area contributed by the head decreases from childhood to adult, while the percent contributed by the leg increases.

*Phillips et al. (1993) - Distributions of Total Skin Surface Area to Body Weight Ratios* - Phillips et al. (1993) observed a strong correlation (0.986) between body surface area and body weight and studied the effect of using these factors as independent variables in the LADD equation. Phillips et al. (1993) concluded that, because of the correlation between these two variables, the use of body surface area to body weight (SA/BW) ratios in human exposure assessments is more appropriate than treating these factors as independent variables. Direct measurement (coating, triangulation, and surface integration) data from the scientific literature were used to calculate body surface area to body weight (SA/BW) ratios for three age groups (infants aged 0 to 2 years, children aged 2.1 to 17.9 years, and adults 18 years and older). These ratios were calculated by dividing body surface areas by corresponding body weights for the 401 individuals analyzed by Gehan and George (1970) and summarized by U.S. EPA (1985). Distributions of SA/BW ratios were developed and summary statistics were calculated for each of the three age groups and the combined data set. Summary statistics for these populations are presented in Table 6-9. The shapes of these SA/BW distributions were determined using



D'Agostino's test. The results indicate that the SA/BW ratios for infants are lognormally distributed and the SA/BW ratios for adults and all ages combined are normally distributed (Figure 6-2). SA/BW ratios for children were neither normally nor lognormally distributed. According to Phillips et al. (1993), SA/BW ratios should be used to calculate LADDs by replacing the body surface area factor in the numerator of the LADD equation with the SA/BW ratio and eliminating the body weight factor in the denominator of the LADD equation.

The effect of gender and age on SA/BW distribution was also analyzed by classifying the 401 observations by gender and age. Statistical analyses indicated no significant differences between SA/BW ratios for males and females. SA/BW ratios were found to decrease with increasing age.

#### 6.2.4. Relevant Surface Area Studies

*Murray and Burmaster (1992) - Estimated Distributions for Total Body Surface Area of Men and Women in the United States* - In this study, distributions of total body surface area for men and women ages 18 to 74 years were estimated using Monte Carlo simulations based on height and weight distribution data. Four different formulae for estimating body surface area as a function of height and weight were employed: Dubois and Dubois (1916); Boyd (1935); U.S. EPA (1985); and Costeff (1966). The formulae of Dubois and Dubois (1916); Boyd (1935); and U.S. EPA (1985) are based on height and weight. They are discussed in Appendix 6A. The formula developed by Costeff (1966) is based on 220 observations that estimate body surface area based on weight only. This formula is:

$SA = 4W + 7\sqrt{W} + 90$ <p>where: SA = Surface Area (m<sup>2</sup>); and W = Weight (kg).</p>	(Eqn. 6-2)
--	------------

Formulae were compared and the effect of the correlation between height and weight on the body surface area distribution was analyzed.

Monte Carlo simulations were conducted to estimate body surface area distributions. They were based on the bivariate distributions estimated by Brainard and Burmaster (1992) for height and natural logarithm of

weight and the formulae described above. A total of 5,000 random samples each for men and women were selected from the two correlated bivariate distributions. Body surface area calculations were made for each sample, and for each formula, resulting in body surface area distributions. Murray and Burmaster (1992), found that the body surface area frequency distributions were similar for the four models (Table 6-10). Using the U.S. EPA (1985) formula, the median surface area values were calculated to be 1.96 m<sup>2</sup> for men and 1.69 m<sup>2</sup> for women. The median value for women is identical to that generated by U.S. EPA (1985) but differs for men by approximately 1 percent. Body surface area was found to have lognormal distributions for both men and women (Figure 6-3). It was also found that assuming correlation between height and weight influences the final distribution by less than 1 percent.

*AIHC (1994) - Exposure Factors Sourcebook* - The Exposure Factors Sourcebook (AIHC, 1994) provides similar body surface area data as presented here. Consistent with this document, average and percentile values are presented on the basis of age and gender. In addition, the Sourcebook presents point estimates of exposed skin surface areas for various scenarios on the basis of several published studies. Finally, the Sourcebook presents probability distributions based on U.S. EPA (1989) and as derived by Thompson and Burmaster (1991); Versar (1991); and Brorby and Finley (1993). For each distribution, the @Risk formula is provided for direct use in the @Risk simulation software (Palisade, 1992). The organization of this document, makes it very convenient to use in support of Monte Carlo analysis. The reviews of the supporting studies are very brief with little analysis of their strengths and weaknesses. The Sourcebook has been classified as a relevant rather than key study because it is not the primary source for the data used to make recommendations in this document. The Sourcebook is very similar to this document in the sense that it summarizes exposure factor data and recommends values. As such, it is clearly relevant as an alternative information source on body surface area as well as other exposure factors.

#### 6.2.5. Application of Body Surface Area Data

In many settings, it is likely that only certain parts of the body are exposed. All body parts that come in contact with a chemical must be considered to estimate the total surface area of the body exposed. The data in Table 6-4 may be used to estimate the total surface area of



Chapter 6 - Dermal

the particular body part(s). For example, to assess exposure to a chemical in a cleaning product for which only the hands are exposed, surface area values for hands from Table 6-4 can be used. For exposure to both hands and arms, mean surface areas for these parts from Table 6-4 may be summed to estimate the total surface area exposed. The mean surface area of these body parts for men and women is as follows:

	Surface Area (m <sup>2</sup> )	
	Men	Women
Arms (includes upper arms and forearms)	0.228	0.210
Hands	0.084	0.075
Total area	0.312	0.285

Therefore, the total body part surface area that may be in contact with the chemical in the cleaning product in this example is 0.312 m<sup>2</sup> for men and 0.285 m<sup>2</sup> for women.

A common assumption is that clothing prevents dermal contact and subsequent absorption of contaminants. This assumption may be false in cases where the chemical may be able to penetrate clothing, such as in a fine dust or liquid suspension. Studies using personal patch monitors placed beneath clothing of pesticide workers exposed to fine mists and vapors show that a significant proportion of dermal exposure may occur at anatomical sites covered by clothing (U.S. EPA, 1992b). In addition, it has been demonstrated that a "pumping" effect can occur which causes material to move under loose clothing (U.S. EPA, 1992b). Furthermore, studies have demonstrated that hands cannot be considered to be protected from exposure even if waterproof gloves are worn (U.S. EPA, 1992b). This may be due to contamination to the interior surface of the gloves when donning or removing them during work activities (U.S. EPA, 1992b). Depending on the task, pesticide workers have been shown to experience 12 percent to 43 percent of their total exposure through their hands, approximately 20 percent to 23 percent through their heads and necks, and 36 percent to 64 percent through their torsos and arms, despite the use of protective gloves and clothing (U.S. EPA, 1992b).

For swimming and bathing scenarios, past exposure assessments have assumed that 75 percent to 100 percent of the skin surface is exposed (U.S. EPA, 1992b). As shown in Table 6-4, total adult body surface areas can vary from about 17,000 cm<sup>2</sup> to 23,000 cm<sup>2</sup>. The mean is reported as approximately 20,000 cm<sup>2</sup>.

For default purposes, adult body surface areas of 20,000 cm<sup>2</sup> (central estimate) to 23,000 cm<sup>2</sup> (upper percentile) are recommended in U.S. EPA (1992b). Tables 6-2 and 6-3 can also be used when the default values are not preferred. Central and upper-percentile values for children should be derived from Table 6-6 or 6-7.

Unlike exposure to liquids, clothing may or may not be effective in limiting the extent of exposure to soil. The 1989 Exposure Factors Handbook presented two adult clothing scenarios for outdoor activities (U.S. EPA, 1989):

**Central tendency mid range:** Individual wears long sleeve shirt, pants, and shoes. The exposed skin surface is limited to the head and hands (2,000 cm<sup>2</sup>).

**Upper percentile:** Individual wears a short sleeve shirt, shorts, and shoes. The exposed skin surface is limited to the head, hands, forearms, and lower legs (5,300 cm<sup>2</sup>).

The clothing scenarios presented above, suggest that roughly 10 percent to 25 percent of the skin area may be exposed to soil. Since some studies have suggested that exposure can occur under clothing, the upper end of this range was selected in *Dermal Exposure Assessment: Principles and Applications* (U.S. EPA, 1992b) for deriving defaults. Thus, taking 25 percent of the total body surface area results in defaults for adults of 5,000 cm<sup>2</sup> to 5,800 cm<sup>2</sup>. These values were obtained from the body surface areas in Table 6-2 after rounding to 20,000 cm<sup>2</sup> and 23,000 cm<sup>2</sup>, respectively. The range of defaults for children can be derived by multiplying the 50th and 95th percentiles by 0.25 for the ages of interest.

When addressing soil contact exposures, assessors may want to refine estimates of surface area exposed on the basis of seasonal conditions. For example, in moderate climates, it may be reasonable to assume that 5 percent of the skin is exposed during the winter, 10 percent during the spring and fall, and 25 percent during the summer.

The previous discussion, has presented information about the area of skin exposed to soil. These estimates of exposed skin area should be useful to assessors using the traditional approach of multiplying the soil adherence factor by exposed skin area to estimate the total amount of soil on skin. The next section presents soil adherence data specific to activity and body part and is designed to be



combined with the total surface area of that body part. No reduction of body part area is made for clothing coverage using this approach. Thus, assessors who adopt this approach, should not use the defaults presented above for soil exposed skin area. Rather, they should use Table 6-4 to obtain total surface areas of specific body parts. See detailed discussion below.

### 6.3. SOIL ADHERENCE TO SKIN

#### 6.3.1. Background

Soil adherence to the surface of the skin is a required parameter to calculate dermal dose when the exposure scenario involves dermal contact with a chemical in soil. A number of studies have attempted to determine the magnitude of dermal soil adherence. These studies are described in detail in U.S. EPA (1992b). This section summarizes recent studies that estimate soil adherence to skin for use as exposure factors.

#### 6.3.2. Key Soil Adherence to Skin Studies

*Kissel et al. (1996a) - Factors Affecting Soil Adherence to Skin in Hand-Press Trials: Investigation of Soil Contact and Skin Coverage* - Kissel et al. (1996a) conducted soil adherence experiments using five soil types (descriptor) obtained locally in the Seattle, Washington, area: sand (211), loamy sand (CP), loamy sand (85), sandy loam (228), and silt loam (72). All soils were analyzed by hydrometer (settling velocity) to determine composition. Clay contents ranged from 0.5 to 7.0 percent. Organic carbon content, determined by combustion, ranged from 0.7 to 4.6 percent. Soils were dry sieved to obtain particle size ranges of <150, 150-250, and >250  $\mu\text{m}$ . For each soil type, the amount of soil adhering to an adult female hand, using both sieved and unsieved soils, was determined by measuring the difference in soil sample weight before and after the hand was pressed into a pan containing the test soil. Loadings were estimated by dividing the recovered soil mass by total hand area, although loading occurred primarily on only one side of the hand. Results showed that generally, soil adherence to hands could be directly correlated with moisture content, inversely correlated with particle size, and independent of clay content or organic carbon content.

*Kissel et al. (1996b) - Field Measurement of Dermal Soil Loading Attributable to Various Activities: Implications for Exposure Assessment* - Further experiments were conducted by Kissel et al. (1996b) to estimate soil adherence associated with various indoor and

outdoor activities: greenhouse gardening, tae kwon do karate, soccer, rugby, reed gathering, irrigation installation, truck farming, and playing in mud. A summary of field studies by activity, gender, age, field conditions, and clothing worn is presented in Table 6-11. Subjects' body surfaces (forearms, hands, lower legs in all cases, faces, and/or feet; pairs in some cases) were washed before and after monitored activities. Paired samples were pooled into single ones. Mass recovered was converted to loading using allometric models of surface area. These data are presented in Table 6-12. Results presented are based on direct measurement of soil loading on the surfaces of skin before and after occupational and recreational activities that may be expected to have soil contact (Kissel et al., 1996b).

#### 6.3.3. Relevant Soil Adherence to Skin Studies

*Lepow et al. (1975) - Investigations into Sources of Lead in the Environment of Urban Children* - This study was conducted to identify the behavioral and environmental factors contributing to elevated lead levels in ten preschool children. The study was performed over 6 to 25 months. Samples of dirt from the hands of subjects were collected during the course of play around the areas where they lived. Prew weighed self-adhesive labels were used to sample a standard area on the palm of the hands of 16 male and female children. The labels were pressed on a single area, often pressed several times, to obtain an adequate sample. In the laboratory, labels were equilibrated in a desiccant cabinet for 24 hours (comparable to the preweighed desiccation), then the total weight was recorded. The mean weight of dirt from the 22 hand sample labels was 11 mg. This corresponds to 0.51  $\text{mg}/\text{cm}^2$ . Lepow et al. (1975) reported that this amount (11 mg) represented only a small fraction (percent not specified) of the total amount of surface dirt present on the hands, because much of the dirt may be trapped in skin folds and creases or there may be a patchy distribution of dirt on hands.

*Roels et al. (1980) - Exposure to Lead by the Oral and the Pulmonary Routes of Children Living in the Vicinity of a Primary Lead Smelter* - Roels et al. (1980) examined blood lead levels among 661 children, 9 to 14 years old, who lived in the vicinity of a large lead smelter in Brussels, Belgium. During five different study periods, lead levels were assessed by rinsing the childrens' hands in 500 mL dilute nitric acid. The amount of lead on the hands was divided by the concentration of lead in soil to



estimate the amount of soil adhering to the hands. The mean soil amount adhering to the hands was 0.159 grams.

*Que Hee et al. (1985) - Evolution of Efficient Methods to Sample Lead Sources, Such as House Dust and Hand Dust, in the Homes of Children* - Que Hee et al. (1985) used soil having particle sizes ranging from  $\leq 44$  to  $833 \mu\text{m}$  diameters, fractionated into six size ranges, to estimate the amount that adhered to the palm of the hand that are assumed to be approximately  $160 \text{ cm}^2$  (test subject with an average total body surface area of  $16,000 \text{ cm}^2$  and a total hand surface area of  $400 \text{ cm}^2$ ). The amount of soil that adhered to skin was determined by applying approximately 5 g of soil for each size fraction, removing excess soil by shaking the hands, and then measuring the difference in weight before and after application. Several assumptions were made to apply these results to other soil types and exposure scenarios: (a) the soil is composed of particles of the indicated diameters; (b) all soil types and particle sizes adhere to the skin to the degree observed in this study; and an equivalent weight of particles of any diameter adhere to the same surface area of skin. On average,  $31.2 \text{ mg}$  of soil adhered to the palm of the hand.

*Driver et al. (1989) - Soil Adherence to Human Skin* - Driver et al. (1989) conducted soil adherence experiments using various soil types collected from sites in Virginia. A total of five soil types were collected: Hyde, Chapanoke, Panorama, Jackland, and Montalto. Both top soils and subsoils were collected for each soil type. The soils were also characterized by cation exchange capacity, organic content, clay mineralogy, and particle size distribution. The soils were dry sieved to obtain particle sizes of  $\leq 250 \mu\text{m}$  and  $\leq 150 \mu\text{m}$ . For each soil type, the amount of soil adhering to adult male hands, using both sieved and unsieved soils, was determined gravimetrically (i.e., measuring the difference in soil sample weight before and after soil application to the hands).

An attempt was made to measure only the minimal or "monolayer" of soil adhering to the hands. This was done by mixing a pre-weighed amount of soil over the entire surface area of the hands for a period of approximately 30 seconds, followed by removal of excess soil by gently rubbing the hands together after contact with the soil. Excess soil that was removed from the hands was collected, weighed, and compared to the original soil sample weight. The authors measured average adherence of  $1.40 \text{ mg/cm}^2$  for particle sizes less than  $150 \mu\text{m}$ ,  $0.95 \text{ mg/cm}^2$  for particle sizes less than  $250$

$\mu\text{m}$ , and  $0.58 \text{ mg/cm}^2$  for unsieved soils. Analysis of variance statistics showed that the most important factor affecting adherence variability was particle size ( $p < 0.001$ ). The next most important factor is soil type and subtype ( $p < 0.001$ ). The interaction of soil type and particle size was also significant, but at a lower significance level ( $p < 0.01$ ).

Driver et al. (1989) found statistically significant increases in soil adherence with decreasing particle size; whereas, Que Hee et al. (1985) found relatively small changes with changes in particle size. The amount of soil adherence found by Driver et al. (1989) was greater than that reported by Que Hee et al. (1985).

*Sedman (1989) - The Development of Applied Action Levels for Soil Contact: A Scenario for the Exposure of Humans to Soil in a Residential Setting* - Sedman (1989) used the estimate from Roels et al. (1980),  $0.159 \text{ g}$ , and the average surface area of the hand of an 11 year old,  $307 \text{ cm}^2$  to estimate the amount of soil adhering per unit area of skin to be  $0.9 \text{ mg/cm}^2$ . This assumed that approximately 60 percent ( $185 \text{ cm}^2$ ) of the lead on the hands was recovered by the method employed by Roels et al. (1980).

Sedman (1989) used estimates from Lepow et al. (1975), Roels et al. (1980), and Que Hee et al. (1985) to develop a maximum soil load that could occur on the skin. A rounded arithmetic mean of  $0.5 \text{ mg/cm}^2$  was calculated from these three studies. According to Sedman (1989), this was near the maximum load of soil that could occur on the skin but it is unlikely that most skin surfaces would be covered with this amount of soil (Sedman, 1989).

*Yang et al. (1989) - In vitro and In vivo Percutaneous Absorption of Benzo[a]pyrene from Petroleum Crude - Fortified Soil in the Rat* - Yang et al. (1989) evaluated the percutaneous absorption of benzo[a]pyrene (BAP) in petroleum crude oil sorbed on soil using a modified *in vitro* technique. This method was used in preliminary experiments to determine the minimum amount of soil adhering to the skin of rats. Based on these results, percutaneous absorption experiments with the crude-sorbed soil were conducted with soil particles of  $< 150 \mu\text{m}$  only. This particle size was intended to represent the composition of the soil adhering to the skin surface. Approximately  $9 \text{ mg/cm}^2$  of soil was found to be the minimum amount required for a "monolayer" coverage of the skin surface in both *in vitro* and *in vivo* experiments. This value is larger than reports for human skin in the studies of Kissel et al., 1996a,b; Lepow et al., 1975; Roels et al., 1980; and Que Hee et al.,



1985. Differences between the rat and human soil adhesion findings may be the result of differences in rat and human skin texture, the types of soils used, soil moisture content or possibly the methods of measuring soil adhesion (Yang et al., 1989).

## **6.4. RECOMMENDATIONS**

### **6.4.1. Body Surface Area**

Body surface area estimates are based on direct measurements. Re-analysis of data collected by Boyd (1935) by several investigators (Gehan and George, 1970; U.S. EPA, 1985; Murray and Burmaster, 1992; Phillips et al., 1993) constitutes much of this literature. Methods are highly reproducible and the results are widely accepted. The representativeness of these data to the general population is somewhat limited since variability due to race or gender have not been systematically addressed.

Individual body surface area studies are summarized in Table 6-13 and the recommendations for body surface area are summarized in Table 6-14. Table 6-15 presents the confidence ratings for various aspects of the recommendations for body surface area. The U.S. EPA (1985) study is based on generally accepted measurements that enjoy widespread usage, summarizes and compares previous reports in the literature, provides statistical distributions for adults, and provides data for total body surface area and body parts by gender for adults and children. However, the results are based on 401 selected measurements from the original 1,114 made by Boyd (1935). More than half of the measurements are from children. Therefore, these estimates may be subject to selection bias and may not be representative of the general population nor specific ethnic groups. Phillips et al. (1993) analyses are based on direct measurement data that provide distributions of body surface area to calculate LADD. The results are consistent with previous efforts to estimate body surface area. Analyses are based on 401 measurements selected from the original 1,114 measurements made by Boyd (1935) and data were not analyzed for specific body parts. The study by Murray and Burmaster (1992) provides frequency distributions for body surface area for men and women and produces results that are similar to those obtained by the U.S. EPA (1985), but do not provide data for body parts nor can results be applied to children.

For most dermal exposure scenarios concerning adults, it is recommended that the body surface areas presented in Table 6-4 be used after determining which body parts will be exposed. Table 6-4 was selected

because these data are straightforward determinations for most scenarios. However, for others, additional considerations may need to be addressed. For example, (1) the type of clothing worn could have a significant effect on the surface area exposed, and (2) climatic conditions will also affect the type of clothing worn and, thus, the skin surface area exposed.

Frequency, event, and exposure duration for water activities and soil contact are presented in Activity Patterns, Volume III, Chapter 15 of this report. For each parameter, recommended values were derived for average and upper percentile values. Each of these considerations are also discussed in more detail in U.S. EPA (1992b). Data in Tables 6-2 and 6-3 can be used when surface area distributions are preferred. A range of recommended values for estimates of the skin surface area of children may be taken from Tables 6-6 and 6-7 using the 50th and 95th percentile values for age(s) of concern. The recommended 50th and 95th percentile values for adult skin surface area provided in U.S. EPA (1992b) are presented in Table 6-16.

### **6.4.2. Soil Adherence to Skin**

Table 6-17 summarizes the relevant and key studies addressing soil adherence to skin. Both Lepow et al. (1975) and Roels et al. (1980) monitored typical exposures in children. They attempted to estimate typical exposure by recovery of accumulated soil from hands at specific time intervals. The efficiency of their sample collection methods is not known and may be subject to error. Only children were studied which may limit generalizing these results to adults. Later studies (Que Hee et al., 1985 and Driver et al., 1989) attempted to characterize both soil properties and sample collection efficiency to estimate adherence of soil to skin. However, the experimental conditions used to expose skin to soil may not reflect typical dermal exposure situations. This provides useful information about the influence of soil characteristics on skin adherence, but the intimate contact of skin with soil required under the controlled experimental conditions in the studies by Driver et al. (1989) and Que Hee et al. (1985) may have exaggerated the amount of adherence over what typically occurs.

More recently, Kissel et al. (1996a; 1996b) have related dermal adherence to soil characteristics and to specific activities. In all cases, experimental design and measurement methods are straightforward and reproducible, but application of results is limited. Both controlled experiments and field studies are based on a



limited number of measurements. Specific situations have been selected to assess soil adherence to skin. Consequently, variation due to individuals, protective clothing, temporal, or seasonal factors remain to be studied in more detail. Therefore, caution is required in interpretation and application of these results for exposure assessments.

These studies are based on limited data, but suggest:

- Soil properties influence adherence. Adherence increases with moisture content, decreases with particle size, but is relatively unaffected by clay or organic carbon content.
- Adherence levels vary considerably across different parts of the body. The highest levels were found on common contact points such as hands, knees, and elbows; the least was detected on the face.
- Adherence levels vary with activity. In general, the highest levels of soil adherence were seen in outdoor workers such as farmers and irrigation system installers, followed by outdoor recreation, and gardening activities. Very high adherence levels were seen in individuals contacting wet soils such as might occur during wading or other shore area recreational activities.

In consideration, of these general observations and the recent data from Kissel et al. (1996a, 1996b), changes are needed from past EPA recommendations which used one adherence value to represent all soils, body parts, and activities. One approach would be to select the activity from Table 6-11 which best represents the exposure scenario of concern and use the corresponding adherence value from Table 6-12. Although this approach represents an improvement, it still has shortcomings. For example, it is difficult to decide which activity in Table 6-12 is most representative of a typical residential setting involving a variety of activities. It may be useful to combine these activities into general classes of low, moderate, and high contact. In the future, it may be possible to combine activity-specific soil adherence estimates with survey-specific soil adherence estimates with survey-derived data on activity frequency and duration to develop overall average soil contact rates.

EPA is sponsoring research to develop such an approach. As this information becomes available, updated recommendations will be issued.

Table 6-12 provides the best estimates available on activity-specific adherence values, but are based on limited data. Therefore, they have a high degree of uncertainty such that considerable judgment must be used when selecting them for an assessment. The confidence ratings for various aspects of this recommendation are summarized in Table 6-18. Insufficient data are available to develop a distribution or a probability function for soil loadings.

Past EPA guidance has recommended assuming that soil exposure occurs primarily to exposed body surfaces and used typical clothing scenarios to derive estimates of exposed skin area. The approach recommended above for estimating soil adherence addresses this issue in a different manner. This change was motivated by two developments. First, increased acceptance that soil and dust particles can get under clothing and be deposited on skin. Second, recent studies of soil adherence have measured soil on entire body parts (whether or not they were covered by clothing) and averaged the amount of soil adhering to skin over the area of entire body part. The soil adherence levels resulting from these new studies must be combined with the surface area of the entire body part (not merely unclothed surface area) to estimate the amount of contaminant on skin. An important caveat, however, is that this approach assumes that clothing in the exposure scenario of interest matches the clothing in the studies used to derive these adherence levels such that the same degree of protection provided by clothing can be assumed in both cases. If clothing differs significantly between the studies reported here and the exposure scenarios under investigation, considerable judgment is needed to adjust either the adherence level or surface area assumption.

The dermal adherence value represents the amount of soil on the skin at the time of measurement. Assuming that the amount measured on the skin represents its accumulation between washings and that people wash at least once per day, these adherence values can be interpreted as daily contact rates (U.S. EPA, 1992b). However, this is not recommended because the residence time of soils on skin has not been studied. Instead, it is recommended that these adherence values be interpreted on an event basis (U.S. EPA, 1992b).





6.5. REFERENCES FOR CHAPTER 6

- American Industrial Health Council (AIHC). (1994) Exposure factors sourcebook. Washington, DC: AIHC.
- Boyd, E. (1935) The growth of the surface area of the human body. Minneapolis, Minnesota: University of Minnesota Press.
- Brainard, J.B.; Burmaster, D.E. (1992) Bivariate distributions for height and weight, men and women in the United States. *Risk Anal.* 12(2):267-275.
- Brorby, G.; Finley B. (1993) Standard probability density functions for routine use in environmental health risk assessment. Presented at the Society of Risk Analysis Annual Meeting, December 1993, Savannah, GA.
- Buhyoff, G.J.; Rauscher, H.M.; Hull, R.B.; Killeen, K.; Kirk, R.C. (1982) User's Manual for Statistical Processing System (version 3C.1). Southeast Technical Associates, Inc.
- Costeff, H. (1966) A simple empirical formula for calculating approximate surface area in children. *Arch. Dis. Childh.* 41:681-683.
- Driver, J.H.; Konz, J.J.; Whitmyre, G.K. (1989) Soil adherence to human skin. *Bull. Environ. Contam. Toxicol.* 43:814-820.
- Dubois, D.; Dubois, E.F. (1916) A formula to estimate the approximate surface area if height and weight be known. *Arch. of Intern. Med.* 17:863-871.
- Gehan, E.; George, G.L. (1970) Estimation of human body surface area from height and weight. *Cancer Chemother. Rep.* 54(4):225-235.
- Geigy Scientific Tables (1981) Nomograms for determination of body surface area from height and mass. Lentner, C. (ed.). CIBA-Geigy Corporation, West Caldwell, NJ. pp. 226-227.
- George, S.L.; Gehan, E.A.; Haycock, G.B.; Schwartz, G.J. (1979) Letters to the editor. *J. Ped.* 94(2):342.
- Haycock, G.B.; Schwartz, G.J.; Wisotsky, D.H. (1978) Geometric method for measuring body surface area: A height-weight formula validated in infants, children, and adults. *J. Ped.* 93(1):62-66.
- Holmes, K.K.; Kissel, J.C.; Richter, K.Y. (1996) Investigation of the influence of oil on soil adherence to skin. *J. Soil Contam.* 5(4):301-308.
- Kissel, J.; Richter, K.; Duff, R.; Fenske, R. (1996a) Factors Affecting Soil Adherence to Skin in Hand-Press Trials. *Bull. Environ. Contamin. Toxicol.* 56:722-728.
- Kissel, J.; Richter, K.; Fenske, R. (1996b) Field measurements of dermal soil loading attributable to various activities: Implications for exposure assessment. *Risk Anal.* 16(1):116-125.
- Lepow, M.L.; Bruckman, L.; Gillette, M.; Markowitz, S.; Rubino, R.; Kaphis, J. (1975) Investigations into sources of lead in the environment of urban children. *Environ. Res.* 10:415-426.
- Murray, D.M.; Burmaster, D.E. (1992) Estimated distributions for total surface area of men and women in the United States. *J. Expos. Anal. Environ. Epidemiol.* 3(4):451-462.
- Palisade. (1992) @Risk users guide. Palisade Corporation, Newfield, NY.
- Phillips, L.J.; Fares, R.J.; Schweer, L.G. (1993) Distributions of total skin surface area to body weight ratios for use in dermal exposure assessments. *J. Expos. Anal. Environ. Epidemiol.* 3(3):331-338.
- Popendorf, W.J.; Leffingwell, J.T. (1976) Regulating OP pesticide residues for farmworker protection. In: *Residue Review 82*. New York, NY: Springer-Verlag New York, Inc., 1982. pp. 125-201.
- Que Hee, S.S.; Peace, B.; Clark, C.S.; Boyle, J.R.; Bornschein, R.L.; Hammond, P.B. (1985) Evolution of efficient methods to sample lead sources, such as house dust and hand dust, in the homes of children. *Environ. Res.* 38: 77-95.
- Rochon, J.; Kalsbeek, W.D. (1983) Variance estimation from multi-stage sample survey data: the jackknife repeated replicate approach. Presented at 1983 SAS Users Group Conference, New Orleans, Louisiana, January 1983.
- Roels, H.A.; Buchet, J.P.; Lauwenys, R.R.; Branx, P.; Claeys-Thoreau, F.; Lafontaine, A.; Verduyn, G. (1980) Exposure to lead by oral and pulmonary routes of children living in the vicinity of a primary lead smelter. *Environ. Res.* 22:81-94.
- Sedman, R.M. (1989) The development of applied action levels for soil contact: a scenario for the exposure of humans to soil in a residential setting. *Environ. Health Perspect.* 79:291-313.
- Sendroy, J.; Cecchini, L.P. (1954) Determination of human body surface area from height and weight. *J. Appl. Physiol.* 7(1):3-12.



---

*Chapter 6 - Dermal*

---

- Thompson, K.M.; Burmaster, D.E. (1991) Parametric distributions for soil ingestion by children. *Risk Anal.* 11(2):339-342.
- U.S. EPA. (1985) Development of statistical distributions or ranges of standard factors used in exposure assessments. Washington, DC: Office of Research and Development, Office of Health and Environmental Assessment. EPA 600/8-85-010. Available from: NTIS, Springfield, VA. PB85-242667.
- U.S. EPA. (1989) Exposure factors handbook. Washington, DC: Office of Research and Development, Office of Health and Environmental Assessment. EPA/600/18-89/043.
- U.S. EPA. (1992a) Guidelines for exposure assessment. *Federal Register.* FR 57:104:22888-22938. May 29, 1992.
- U.S. EPA. (1992b) Dermal exposure assessment: principles and applications. Washington, DC: Office of Research and Development, Office of Health and Environmental Assessment/OHEA. U.S. EPA/600/8-9-91.
- Van Graan, C.H. (1969) The determination of body surface area. *Supplement to the South African J. of Lab. and Clin. Med.* 8-2-69.
- Versar, Inc. (1991) Analysis of the impact of exposure assumptions on risk assessment of chemicals in the environment, phase II: uncertainty analyses of existing exposure assessment methods. Draft Report. Prepared for Exposure Assessment Task Group, Chemical Manufacturers Association, Washington, DC.
- Yang, J.J.; Roy, T.A.; Krueger, A.J.; Neil, W.; Mackerer, C.R. (1989) In vitro and in vivo percutaneous absorption of benzo[a]pyrene from petroleum crude-fortified soil in the rat. *Bull. Environ. Contam. Toxicol.* 43: 207-214.

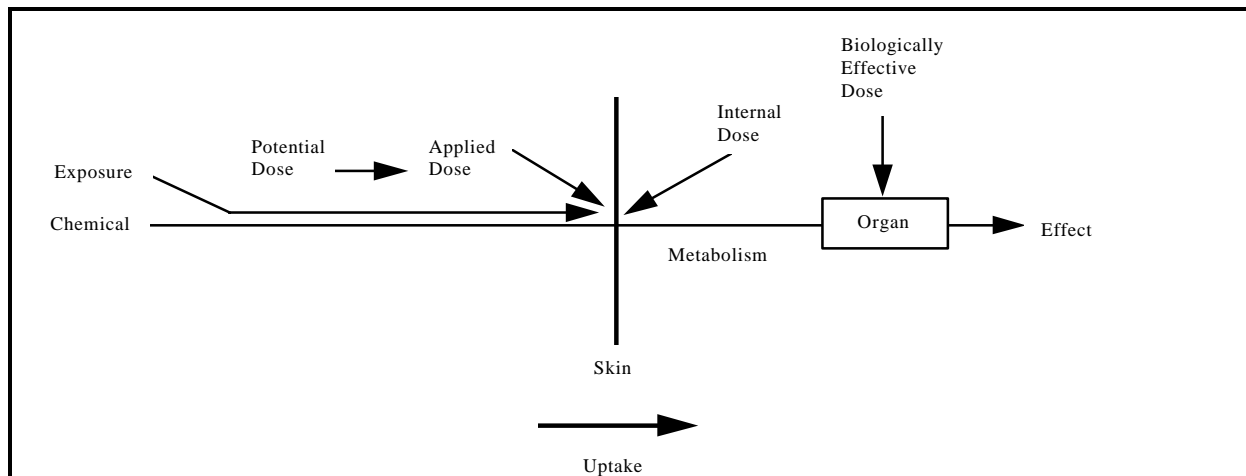

Figure 6-1. Schematic of Dose and Exposure: Dermal Route

Source: U.S. EPA, 1992a.

Table 6-1. Summary of Equation Parameters for Calculating Adult Body Surface Area

Body Part	N	Equation for surface areas (m <sup>2</sup> )			P	R <sup>2</sup>	S.E.
		a <sub>0</sub>	W <sup>a1</sup>	H <sup>a2</sup>			
Head							
Female	57	0.0256	0.124	0.189	0.01	0.302	0.00678
Male	32	0.0492	0.339	-0.0950	0.01	0.222	0.0202
Trunk							
Female	57	0.188	0.647	-0.304	0.001	0.877	0.00567
Male	32	0.0240	0.808	-0.0131	0.001	0.894	0.0118
Upper Extremities							
Female	57	0.0288	0.341	0.175	0.001	0.526	0.00833
Male	48	0.00329	0.466	0.524	0.001	0.821	0.0101
Arms							
Female	13	0.00223	0.201	0.748	0.01	0.731	0.00996
Male	32	0.00111	0.616	0.561	0.001	0.892	0.0177
Upper Arms							
Male	6	8.70	0.741	-1.40	0.25	0.576	0.0387
Forearms							
Male	6	0.326	0.858	-0.895	0.05	0.897	0.0207
Hands							
Female	12 <sup>b</sup>	0.0131	0.412	0.0274	0.1	0.447	0.0172
Male	32	0.0257	0.573	-0.218	0.001	0.575	0.0187
Lower Extremities <sup>c</sup>	105	0.00286	0.458	0.696	0.001	0.802	0.00633
Legs	45	0.00240	0.542	0.626	0.001	0.780	0.0130
Thighs	45	0.00352	0.629	0.379	0.001	0.739	0.0149
Lower legs	45	0.000276	0.416	0.973	0.001	0.727	0.0149
Feet	45	0.000618	0.372	0.725	0.001	0.651	0.0147

<sup>a</sup> SA = a<sub>0</sub> W<sup>a1</sup> H<sup>a2</sup>  
W = Weight in kilograms; H = Height in centimeters; P = Level of significance; R<sup>2</sup> = Coefficient of determination;  
SA = Surface Area; S.E. = Standard error; N = Number of observations  
<sup>b</sup> One observation for a female whose body weight exceeded the 95 percentile was not used.  
<sup>c</sup> Although two separate regressions were marginally indicated by the F test, pooling was done for consistency with individual components of lower extremities.

Source: U.S. EPA, 1985.



Chapter 6 - Dermal

Table 6-2. Surface Area of Adult Males in Square Meters										
Body part	Percentile									S.E. <sup>a</sup>
	5	10	15	25	50	75	85	90	95	
Total	1.66	1.72	1.76	1.82	1.94	2.07	2.14	2.20	2.28	0.00374
Head	0.119	0.121	0.123	0.124	0.130	0.135	0.138	0.140	0.143	0.0202
Trunk <sup>b</sup>	0.591	0.622	0.643	0.674	0.739	0.807	0.851	0.883	0.935 <sup>c</sup>	0.0118
Upper extremities	0.321	0.332	0.340	0.350	0.372	0.395	0.408	0.418	0.432 <sup>c</sup>	0.00101
Arms	0.241	0.252	0.259	0.270	0.291	0.314 <sup>c</sup>	0.328 <sup>c</sup>	0.339 <sup>c</sup>	0.354 <sup>c</sup>	0.00387
Forearms	0.106	0.111	0.115	0.121	0.131	0.144 <sup>c</sup>	0.151 <sup>c</sup>	0.157 <sup>c</sup>	0.166 <sup>c</sup>	0.0207
Hands	0.085	0.088	0.090	0.093	0.099	0.105	0.109	0.112	0.117	0.0187
Lower extremities	0.653	0.676	0.692	0.715	0.761	0.810	0.838	0.858	0.888 <sup>c</sup>	0.00633
Legs	0.539	0.561	0.576	0.597	0.640	0.686 <sup>c</sup>	0.714 <sup>c</sup>	0.734 <sup>c</sup>	0.762 <sup>c</sup>	0.0130
Thighs	0.318	0.331	0.341	0.354	0.382	0.411 <sup>c</sup>	0.429 <sup>c</sup>	0.443 <sup>c</sup>	0.463 <sup>c</sup>	0.0149
Lower legs	0.218	0.226	0.232	0.240	0.256	0.272	0.282	0.288	0.299	0.0149
Feet	0.114	0.118	0.120	0.124	0.131	0.138	0.142	0.145	0.149	0.0147

<sup>a</sup> Standard error for the 5-95 percentile of each body part.  
<sup>b</sup> Trunk includes neck.  
<sup>c</sup> Percentile estimates exceed the maximum measured values upon which the equations are based.  
Source: U.S. EPA, 1985.

Table 6-3. Surface Area of Adult Females in Square Meters										
Body part	Percentile									S.E. <sup>a</sup>
	5	10	15	25	50	75	85	90	95	
Total	1.45	1.49	1.53	1.58	1.69 <sup>c</sup>	1.82	1.91	1.98	2.09	0.00374
Head	0.106	0.107	0.108	0.109	0.111	0.113	0.114	0.115	0.117	0.00678
Trunk <sup>b</sup>	0.490	0.507	0.518	0.538	0.579	0.636	0.677	0.704	0.752	0.00567
Upper extremities	0.260	0.265	0.269	0.274	0.287	0.301	0.311	0.318	0.329	0.00833
Arms	0.210	0.214	0.217	0.221	0.230	0.238 <sup>c</sup>	0.243 <sup>c</sup>	0.247 <sup>c</sup>	0.253 <sup>c</sup>	0.00996
Hands	0.0730	0.0746	0.0757	0.0777	0.0817	0.0868 <sup>c</sup>	0.0903 <sup>c</sup>	0.0927 <sup>c</sup>	0.0966 <sup>c</sup>	0.0172
Lower extremities	0.564	0.582	0.595	0.615	0.657	0.704	0.736	0.757	0.796	0.00633
Legs	0.460	0.477	0.488	0.507	0.546	0.592	0.623	0.645	0.683 <sup>c</sup>	0.0130
Thighs	0.271	0.281	0.289	0.300	0.326	0.357	0.379	0.394	0.421 <sup>c</sup>	0.0149
Lower legs	0.186	0.192	0.197	0.204	0.218	0.233	0.243	0.249	0.261	0.0149
Feet	0.100	0.103	0.105	0.108	0.114	0.121	0.126	0.129	0.134	0.0147

<sup>a</sup> Standard error for the 5-95 percentile of each body part.  
<sup>b</sup> Trunk includes neck.  
<sup>c</sup> Percentile estimates exceed the maximum measured values upon which the equations are based.  
Source: U.S. EPA, 1985.



Table 6-4. Surface Area by Body Part for Adults (m<sup>2</sup>)

Body part	Men						Women					
	N <sup>a</sup>	Mean	(sd) <sup>b</sup>	Min.	-	Max.	N	Mean	(sd)	Min.	-	Max.
Head	32	0.118	(0.0160)	0.090	-	0.161	57	0.110	(0.00625)	0.0953	-	0.127
Trunk (Incl. Neck)	32	0.569	(0.104)	0.306	-	0.893	57	0.542	(0.0712)	0.437	-	0.867
Upper extremities	48	0.319	(0.0461)	0.169	-	0.429	57	0.276	(0.0241)	0.215	-	0.333
Arms	32	0.228	(0.0374)	0.109	-	0.292	13	0.210	(0.0129)	0.193	-	0.235
Upper arms	6	0.143	(0.0143)	0.122	-	0.156	-	-	-	-	-	-
Forearms	6	0.114	(0.0127)	0.0945	-	0.136	-	-	-	-	-	-
Hands	32	0.084	(0.0127)	0.0596	-	0.113	12	0.0746	(0.00510)	0.0639	-	0.0824
Lower extremities	48	0.636	(0.0994)	0.283	-	0.868	57	0.626	(0.0675)	0.492	-	0.809
Legs	32	0.505	(0.0885)	0.221	-	0.656	13	0.488	(0.0515)	0.423	-	0.585
Thighs	32	0.198	(0.1470)	0.128	-	0.403	13	0.258	(0.0333)	0.258	-	0.360
Lower legs	32	0.207	(0.0379)	0.093	-	0.296	13	0.194	(0.0240)	0.165	-	0.229
Feet	32	0.112	(0.0177)	0.0611	-	0.156	13	0.0975	(0.00903)	0.0834	-	0.115
TOTAL		1.94 <sup>c</sup>	(0.00374) <sup>d</sup>	1.66	-	2.28 <sup>e</sup>		1.69 <sup>c</sup>	(0.00374) <sup>d</sup>	1.45	-	2.09 <sup>e</sup>

<sup>a</sup> number of observations.  
<sup>b</sup> standard deviation.  
<sup>c</sup> median (see Table 6-2).  
<sup>d</sup> standard error.  
<sup>e</sup> percentiles (5th - 95th).  
Source: Adapted from U.S. EPA, 1985.

Table 6-5. Percentage of Total Body Surface Area by Part for Adults

Body part	Men						Women					
	N <sup>a</sup>	Mean	(s.d.) <sup>b</sup>	Min.	-	Max.	N	Mean	(s.d.)	Min.	-	Max.
Head	32	7.8	(1.0)	6.1	-	10.6	57	7.1	(0.6)	5.6	-	8.1
Trunk	32	35.9	(2.1)	30.5	-	41.4	57	34.8	(1.9)	32.8	-	41.7
Upper extremities	48	18.8	(1.1)	16.4	-	21.0	57	17.9	(0.9)	15.6	-	19.9
Arms	32	14.1	(0.9)	12.5	-	15.5	13	14.0	(0.6)	12.4	-	14.8
Upper arms	6	7.4	(0.5)	6.7	-	8.1	-	-	-	-	-	-
Forearms	6	5.9	(0.3)	5.4	-	6.3	-	-	-	-	-	-
Hands	32	5.2	(0.5)	4.6	-	7.0	12	5.1	(0.3)	4.4	-	5.4
Lower extremities	48	37.5	(1.9)	33.3	-	41.2	57	40.3	(1.6)	36.0	-	43.2
Legs	32	31.2	(1.6)	26.1	-	33.4	13	32.4	(1.6)	29.8	-	35.3
Thighs	32	18.4	(1.2)	15.2	-	20.2	13	19.5	(1.1)	18.0	-	21.7
Lower legs	32	12.8	(1.0)	11.0	-	15.8	13	12.8	(1.0)	11.4	-	14.9
Feet	32	7.0	(0.5)	6.0	-	7.9	13	6.5	(0.3)	6.0	-	7.0

<sup>a</sup> Number of observations.  
<sup>b</sup> Standard deviation.  
Source: Adapted from U.S. EPA, 1985.



Table 6-6. Total Body Surface Area of Male Children in Square Meters <sup>a</sup>									
Age (yr) <sup>b</sup>	Percentile								
	5	10	15	25	50	75	85	90	95
2 < 3	0.527	0.544	0.552	0.569	0.603	0.629	0.643	0.661	0.682
3 < 4	0.585	0.606	0.620	0.636	0.664	0.700	0.719	0.729	0.764
4 < 5	0.633	0.658	0.673	0.689	0.731	0.771	0.796	0.809	0.845
5 < 6	0.692	0.721	0.732	0.746	0.793	0.840	0.864	0.895	0.918
6 < 7	0.757	0.788	0.809	0.821	0.866	0.915	0.957	1.01	1.06
7 < 8	0.794	0.832	0.848	0.877	0.936	0.993	1.01	1.06	1.11
8 < 9	0.836	0.897	0.914	0.932	1.00	1.06	1.12	1.17	1.24
9 < 10	0.932	0.966	0.988	1.00	1.07	1.13	1.16	1.25	1.29
10 < 11	1.01	1.04	1.06	1.10	1.18	1.28	1.35	1.40	1.48
11 < 12	1.00	1.06	1.12	1.16	1.23	1.40	1.47	1.53	1.60
12 < 13	1.11	1.13	1.20	1.25	1.34	1.47	1.52	1.62	1.76
13 < 14	1.20	1.24	1.27	1.30	1.47	1.62	1.67	1.75	1.81
14 < 15	1.33	1.39	1.45	1.51	1.61	1.73	1.78	1.84	1.91
15 < 16	1.45	1.49	1.52	1.60	1.70	1.79	1.84	1.90	2.02
16 < 17	1.55	1.59	1.61	1.66	1.76	1.87	1.98	2.03	2.16
17 < 18	1.54	1.56	1.62	1.69	1.80	1.91	1.96	2.03	2.09
3 < 6	0.616	0.636	0.649	0.673	0.728	0.785	0.817	0.842	0.876
6 < 9	0.787	0.814	0.834	0.866	0.931	1.01	1.05	1.09	1.14
9 < 12	0.972	1.00	1.02	1.07	1.16	1.28	1.36	1.42	1.52
12 < 15	1.19	1.24	1.27	1.32	1.49	1.64	1.73	1.77	1.85
15 < 18	1.50	1.55	1.59	1.65	1.75	1.86	1.94	2.01	2.11

<sup>a</sup> Lack of height measurements for children <2 years in NHANES II precluded calculation of surface areas for this age group.  
<sup>b</sup> Estimated values calculated using NHANES II data.  
 Source: U.S. EPA, 1985.

Table 6-7. Total Body Surface Area of Female Children in Square Meters <sup>a</sup>									
Age (yr) <sup>b</sup>	Percentile								
	5	10	15	25	50	75	85	90	95
2 < 3	0.516	0.532	0.544	0.557	0.579	0.610	0.623	0.637	0.653
3 < 4	0.555	0.570	0.589	0.607	0.649	0.688	0.707	0.721	0.737
4 < 5	0.627	0.639	0.649	0.666	0.706	0.758	0.777	0.794	0.820
5 < 6	0.675	0.700	0.714	0.735	0.779	0.830	0.870	0.902	0.952
6 < 7	0.723	0.748	0.770	0.791	0.843	0.914	0.961	0.989	1.03
7 < 8	0.792	0.808	0.819	0.854	0.917	0.977	1.02	1.06	1.13
8 < 9	0.863	0.888	0.913	0.932	1.00	1.05	1.08	1.11	1.18
9 < 10	0.897	0.948	0.969	1.01	1.06	1.14	1.22	1.31	1.41
10 < 11	0.981	1.01	1.05	1.10	1.17	1.29	1.34	1.37	1.43
11 < 12	1.06	1.09	1.12	1.16	1.30	1.40	1.50	1.56	1.62
12 < 13	1.13	1.19	1.24	1.27	1.40	1.51	1.62	1.64	1.70
13 < 14	1.21	1.28	1.32	1.38	1.48	1.59	1.67	1.75	1.86
14 < 15	1.31	1.34	1.39	1.45	1.55	1.66	1.74	1.76	1.88
15 < 16	1.38	1.49	1.43	1.47	1.57	1.67	1.72	1.76	1.83
16 < 17	1.40	1.46	1.48	1.53	1.60	1.69	1.79	1.84	1.91
17 < 18	1.42	1.49	1.51	1.56	1.63	1.73	1.80	1.84	1.94
3 < 6	0.585	0.610	0.630	0.654	0.711	0.770	0.808	0.831	0.879
6 < 9	0.754	0.790	0.804	0.845	0.919	1.00	1.04	1.07	1.13
9 < 12	0.957	0.990	1.03	1.06	1.16	1.31	1.38	1.43	1.56
12 < 15	1.21	1.27	1.30	1.37	1.48	1.61	1.68	1.74	1.82
15 < 18	1.40	1.44	1.47	1.51	1.60	1.70	1.76	1.82	1.92

<sup>a</sup> Lack of height measurements for children <2 years in NHANES II precluded calculation of surface areas for this age group.  
<sup>b</sup> Estimated values calculated using NHANES II data.  
 Source: U.S. EPA, 1985.



Table 6-8. Percentage of Total Body Surface Area by Body Part for Children

Age (yr)	N M:F	Percent of Total											
		Head		Trunk		Arms		Hands		Legs		Feet	
		Mean	Min-Max	Mean	Min-Max	Mean	Min-Max	Mean	Min-Max	Mean	Min-Max	Mean	Min-Max
< 1	2:0	18.2	18.2-18.3	35.7	34.8-36.6	13.7	12.4-15.1	5.3	5.21-5.39	20.6	18.2-22.9	6.54	6.49-6.59
1 < 2	1:1	16.5	16.5-16.5	35.5	34.5-36.6	13.0	12.8-13.1	5.68	5.57-5.78	23.1	22.1-24.0	6.27	5.84-6.70
2 < 3	1:0	14.2		38.5		11.8		5.30		23.2		7.07	
3 < 4	0:5	13.6	13.3-14.0	31.9	29.9-32.8	14.4	14.2-14.7	6.07	5.83-6.32	26.8	26.0-28.6	7.21	6.80-7.88
4 < 5	1:3	13.8	12.1-15.3	31.5	30.5-32.4	14.0	13.0-15.5	5.70	5.15-6.62	27.8	26.0-29.3	7.29	6.91-8.10
5 < 6													
6 < 7	1:0	13.1		35.1		13.1		4.71		27.1		6.90	
7 < 8													
8 < 9													
9 < 10	0:2	12.0	11.6-12.5	34.2	33.4-34.9	12.3	11.7-12.8	5.30	5.15-5.44	28.7	28.5-28.8	7.58	7.38-7.77
10 < 11													
11 < 12													
12 < 13	1:0	8.74		34.7		13.7		5.39		30.5		7.03	
13 < 14	1:0	9.97		32.7		12.1		5.11		32.0		8.02	
14 < 15													
15 < 16													
16 < 17	1:0	7.96		32.7		13.1		5.68		33.6		6.93	
17 < 18	1:0	7.58		31.7		17.5		5.13		30.8		7.28	

N: Number of subjects, male to female ratios.  
Source: U.S. EPA 1985.



Table 6-9. Descriptive Statistics for Surface Area/Body Weight (SA/BW) Ratios (m <sup>2</sup> /kg)											
Age (yrs.)	Mean	Range Min-Max	SD <sup>a</sup>	SE <sup>b</sup>	Percentiles						
					5	10	25	50	75	90	95
0-2	0.0641	0.0421-0.1142	0.0114	7.84e-4	0.0470	0.0507	0.0563	0.0617	0.0719	0.0784	0.0846
2.1 - 17.9	0.0423	0.0268-0.0670	0.0076	1.05e-3	0.0291	0.0328	0.0376	0.0422	0.0454	0.0501	0.0594
≥ 18	0.0284	0.0200-0.0351	0.0028	7.68e-6	0.0238	0.0244	0.0270	0.0286	0.0302	0.0316	0.0329
All ages	0.0489	0.0200-0.1142	0.0187	9.33e-4	0.0253	0.0272	0.0299	0.0495	0.0631	0.0740	0.0788
<sup>a</sup> Standard deviation. <sup>b</sup> Standard error of the mean. Source: Phillips et al., 1993.											

Table 6-10. Statistical Results for Total Body Surface Area Distributions (m <sup>2</sup> )				
	Men			
	U.S. EPA	Boyd	DuBois and DuBois	Costeff
Mean	1.97	1.95	1.94	1.89
Median	1.96	1.94	1.94	1.89
Mode	1.96	1.91	1.90	1.90
Standard Deviation	0.19	0.18	0.17	0.16
Skewness	0.27	0.26	0.23	0.04
Kurtosis	3.08	3.06	3.02	2.92
	Women			
	U.S. EPA	Boyd	DuBois and DuBois	Costeff
Mean	1.73	1.71	1.69	1.71
Median	1.69	1.68	1.67	1.68
Mode	1.68	1.62	1.60	1.66
Standard Deviation	0.21	0.20	0.18	0.21
Skewness	0.92	0.88	0.77	0.69
Kurtosis	4.30	4.21	4.01	3.52
Source: Murray and Burmaster, 1992				



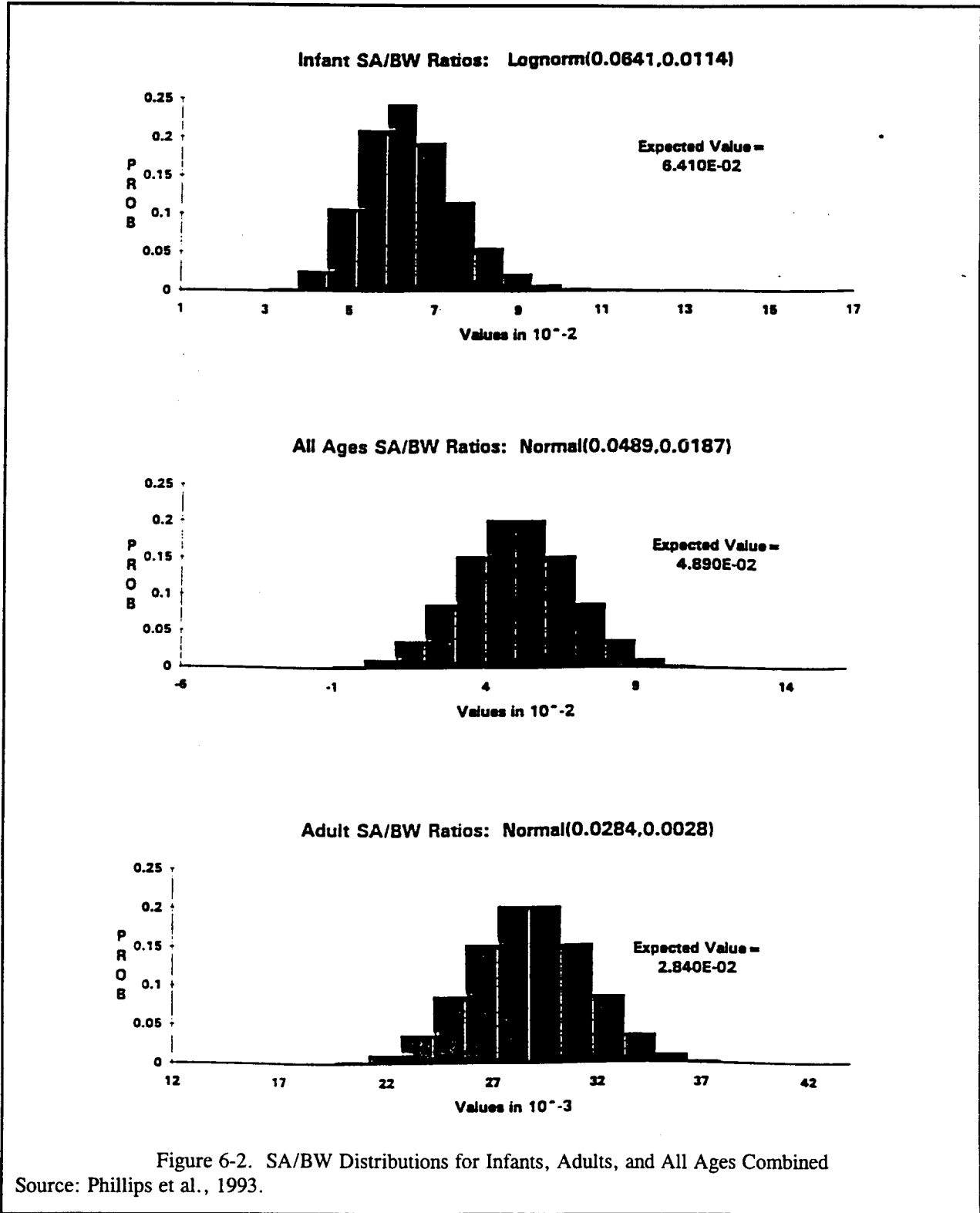

Figure 6-2. SA/BW Distributions for Infants, Adults, and All Ages Combined  
 Source: Phillips et al., 1993.

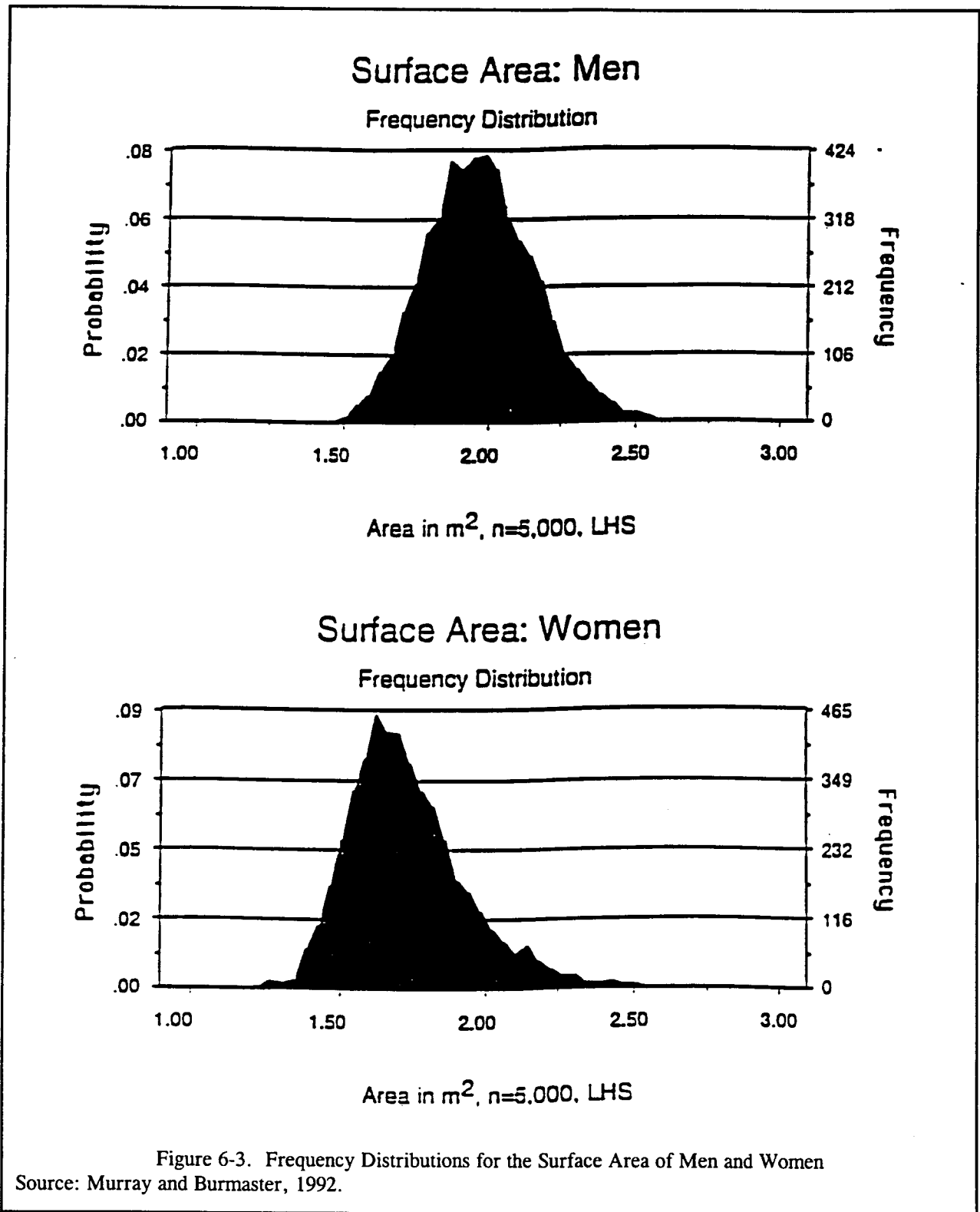



Table 6-11. Summary of Field Studies

Activity	Month	Event <sup>a</sup> (hrs)	N <sup>b</sup>	M	F	Age	Conditions	Clothing
<u>Indoor</u>								
Tae Kwon Do	Feb.	1.5	7	6	1	8-42	Carpeted floor	All in long-sleeve-long pants martial arts uniform, sleeves rolled back, barefoot
Greenhouse Workers	Mar.	5.25	2	1	1	37-39	Plant watering, spraying, soil blending, sterilization	Long pants, elbow length short sleeve shirt, no gloves
Indoor Kids No. 1	Jan.	2	4	3	1	6-13	Playing on carpeted floor	3 of 4 short pants, 2 of 4 short sleeves, socks, no shoes
Indoor Kids No. 2	Feb.	2	6	4	2	3-13	Playing on carpeted floor	5 of 6 long pants, 5 of 6 long sleeves, socks, no shoes
<b>Indoor Totals</b>				<b>19</b>	<b>14</b>	<b>5</b>		
<u>Outdoor</u>								
Daycare Kids No. 1a	Aug.	3.5	6	5	1	1-6.5	Indoors: linoleum surface; outdoors: grass, bare earth, barked area	4 of 6 in long pants, 4 of 6 short sleeves, shoes
Daycare Kids No. 1b	Aug.	4	6	5	1	1-6.5	Indoors: linoleum surface; outdoors: grass, bare earth, barked area	4 of 6 in long pants, 4 of 6 short sleeves, no shoes
Daycare Kids No.2c	Sept.	8	5	4	1	1-4	Indoors, low napped carpeting, linoleum surfaces	4 of 5 long pants, 3 of 5 long sleeves, all barefoot for part of the day
Daycare Kids No. 3	Nov.	8	4	3	1	1-4.5	Indoors: linoleum surface, outside: grass, bare earth, barked area	All long pants, 3 of 4 long sleeves, socks and shoes
Soccer No. 1	Nov.	0.67	8	8	0	13-15	Half grass-half bare earth	6 of 8 long sleeves, 4 of 8 long pants, 3 of 4 short pants and shin guards
Soccer No. 2	Mar.	1.5	8	0	8	24-34	All-weather field (sand-ground tires)	All in short sleeve shirts, shorts, knee socks, shin guards
Soccer No. 3	Nov.	1.5	7	0	7	24-34	All-weather field (sand-ground tires)	All in short sleeve shirts, shorts, knee socks, shin guards
Groundskeepers No. 1	Mar.	1.5	2	1	1	29-52	Campus grounds, urban horticulture center, arboretum	All in long pants, intermittent use of gloves
Groundskeepers No. 2	Mar.	4.25	5	3	2	22-37	Campus grounds, urban horticulture center, arboretum	All in long pants, intermittent use of gloves
Groundskeepers No. 3	Mar.	8	7	5	2	30-62	Campus grounds, urban horticulture center, arboretum	All in long pants, intermittent use of gloves
Groundskeepers No. 4	Aug.	4.25	7	4	3	22-38	Campus grounds, urban horticulture center, arboretum	5 of 7 in short sleeve shirts, intermittent use of gloves
Groundskeepers No. 5	Aug.	8	8	6	2	19-64	Campus grounds, urban horticulture center, arboretum	5 of 8 in short sleeve shirts, intermittent use of gloves
Landscape/Rockery	June	9	4	3	1	27-43	Digging (manual and mechanical), rock moving	All long pants, 2 long sleeves, all socks and boots
Irrigation Installers	Oct.	3	6	6	0	23-41	Landscaping, surface restoration	All in long pants, 3 of 6 short sleeve or sleeveless shirts
Gardeners No. 1	Aug.	4	8	1	7	16-35	Weeding, pruning, digging a trench	6 of 8 long pants, 7 of 8 short sleeves, 1 sleeveless, socks, shoes, intermittent use of gloves



Table 6-11. Summary of Field Studies (continued)

Activity	Month	Event <sup>a</sup> (hrs)	N <sup>b</sup>	M	F	Age	Conditions	Clothing
Gardeners No. 2	Aug.	4	7	2	5	26-52	Weeding, pruning, digging a trench, picking fruit, cleaning	3 of 7 long pants, 5 of 7 short sleeves, 1 sleeveless, socks, shoes, no gloves
Rugby No. 1	Mar.	1.75	8	8	0	20-22	Mixed grass-barewet field	All in short sleeve shirts, shorts, variable sock lengths
Rugby No. 2	July	2	8	8	0	23-33	Grass field (80% oftime) and all-weather field (mix of gravel, sand, and clay) (20% oftime)	All in shorts, 7 of 8 in short sleeve shirts, 6 of 8 in low socks
Rugby No. 3	Sept.	2.75	7	7	0	24-30	Compacted mixedgrass and bare earth field	All short pants, 7 of 8 short or rolled up sleeves, socks, shoes
Archeologists	July	11.5	7	3	4	16-35	Digging withtrowel, screening dirt, sorting	6 of 7 short pants, all short sleeves, 3 no shoes or socks, 2 sandals
Construction Workers	Sept.	8	8	8	0	21-30	Mixed bare earth and concrete surfaces, dust and debris	5 of 8 pants, 7 of 8 short sleeves, all socks and shoes
Utility Workers No.1	July	9.5	5	5	0	24-45	Cleaning, fixing mains, excavation (backhoe and shovel)	All long pants, short sleeves, socks, boots, gloves sometimes
Utility Workers No.2	Aug.	9.5	6	6	0	23-44	Cleaning, fixing mains, excavation (backhoe and shovel)	All long pants, 5 of 6 short sleeves, socks, boots, gloves sometimes
Equip. Operators No.1	Aug.	8	4	4	0	21-54	Earth scraping withheavy machinery, dusty conditions	All long pants, 3 of 4 short sleeves, socks, boots, 2 of 4 gloves
Equip. Operators No.2	Aug.	8	4	4	0	21-54	Earth scraping withheavy machinery, dusty conditions	All long pants, 3 of 4 short sleeves, socks, boots, 1 gloves
Farmers No. 1	May	2	4	2	2	39-44	Manual weeding, mechanical cultivation	All in long pants, heavy shoes, short sleeve shirts, no gloves
Farmers No. 2	July	2	6	4	2	18-43	Manual weeding, mechanical cultivation	2 of 6 short, 4 of 6 long pants, 1 of 6 long sleeve shirt, no gloves
Reed Gatherers	Aug.	2	4	0	4	42-67	Tidal flats	2 of 4 shortsleeve shirts/knee length pants, all wore shoes
Kids-in-mud No. 1	Sept.	0.17	6	5	1	9-14	Lake shoreline	All in short sleeve T-shirts, shorts, barefoot
Kids-in-mud No. 2	Sept.	0.33	6	5	1	9-14	Lake shoreline	All in short sleeve T-shirts, shorts, barefoot
<b>Outdoor Totals</b>			<b>181</b>	<b>125</b>	<b>56</b>			

<sup>a</sup> Event duration  
<sup>b</sup> Number of subject  
<sup>c</sup> Activities were confined to the house  
Sources: Kissel et al., 1996b; Holmes et al., 1996 (submitted for publication).



Table 6-12. Geometric Mean and Geometric Standard Deviations of Soil Adherence by Activity and Body Region						
Activity	N <sup>a</sup>	Post-activity Dermal Soil Loadings (mg/cm <sup>2</sup> )				
		Hands	Arms	Legs	Faces	Feet
<u>Indoor</u>						
Tae Kwon Do	7	0.0063 1.9	0.0019 4.1	0.0020 2.0		0.0022 2.1
GreenhouseWorkers	2	0.043 --	0.0064 --	0.0015 --	0.0050 --	
Indoor Kids No. 1	4	0.0073 1.9	0.0042 1.9	0.0041 2.3		0.012 1.4
Indoor Kids No. 2	6	0.014 1.5	0.0041 2.0	0.0031 1.5		0.0091 1.7
Daycare Kids No. 1a	6	0.11 1.9	0.026 1.9	0.030 1.7		0.079 2.4
Daycare Kids No. 1b	6	0.15 2.1	0.031 1.8	0.023 1.2		0.13 1.4
Daycare Kids No. 2	5	0.073 1.6	0.023 1.4	0.011 1.4		0.044 1.3
Daycare Kids No. 3	4	0.036 1.3	0.012 1.2	0.014 3.0		0.0053 5.1
<u>Outdoor</u>						
Soccer No. 1	8	0.11 1.8	0.011 2.0	0.031 3.8	0.012 1.5	
Soccer No. 2	8	0.035 3.9	0.0043 2.2	0.014 5.3	0.016 1.5	
Soccer No. 3	7	0.019 1.5	0.0029 2.2	0.0081 1.6	0.012 1.6	
Groundskeepers No. 1	2	0.15 --	0.005 --		0.0021 --	0.018 --
Groundskeepers No. 2	5	0.098 2.1	0.0021 2.6	0.0010 1.5	0.010 2.0	
Groundskeepers No. 3	7	0.030 2.3	0.0022 1.9	0.0009 1.8	0.0044 2.6	0.0040
Groundskeepers No. 4	7	0.045 1.9	0.014 1.8	0.0008 1.9	0.0026 1.6	0.018 --
Groundskeepers No. 5	8	0.032 1.7	0.022 2.8	0.0010 1.4	0.0039 2.1	
Landscape/Rockery	4	0.072 2.1	0.030 2.1		0.0057 1.9	
Irrigation Installers	6	0.19 1.6	0.018 3.2	0.0054 1.8	0.0063 1.3	
Gardeners No. 1	8	0.20 1.9	0.050 2.1	0.072 --	0.058 1.6	0.17 --



Table 6-12. Geometric Mean and Geometric Standard Deviations of Soil Adherence by Activity and Body Region (continued)						
Activity	N <sup>a</sup>	Post-activity Dermal Soil Loadings (mg/cm <sup>2</sup> )				
		Hands	Arms	Legs	Faces	Feet
Gardeners No. 2	7	0.18 3.4	0.054 2.9	0.022 2.0	0.047 1.6	0.26 --
Rugby No. 1	8	0.40 1.7	0.27 1.6	0.36 1.7	0.059 2.7	
Rugby No. 2	8	0.14 1.4	0.11 1.6	0.15 1.6	0.046 1.4	
Rugby No. 3	7	0.049 1.7	0.031 1.3	0.057 1.2	0.020 1.5	
Archeologists	7	0.14 1.3	0.041 1.9	0.028 4.1	0.050 1.8	0.24 1.4
Construction Workers	8	0.24 1.5	0.098 1.5	0.066 1.4	0.029 1.6	
Utility Workers No.1	5	0.32 1.7	0.20 2.7		0.10 1.5	
Utility Workers No. 2	6	0.27 2.1	0.30 1.8		0.10 1.5	
Equip. Operators No. 1	4	0.26 2.5	0.089 1.6		0.10 1.4	
Equip. Operators No. 2	4	0.32 1.6	0.27 1.4		0.23 1.7	
Farmers No. 1	4	0.41 1.6	0.059 3.2	0.0058 2.7	0.018 1.4	
Farmers No. 2	6	0.47 1.4	0.13 2.2	0.037 3.9	0.041 3.0	
Reed Gatherers	4	0.66 1.8	0.036 2.1	0.16 9.2		0.63 7.1
Kids-in-mud No. 1	6	35 2.3	11 6.1	36 2.0		24 3.6
Kids-in-mud No. 2	6	58 2.3	11 3.8	9.5 2.3		6.7 12.4

<sup>a</sup> Number of subjects.  
Sources: Kissel et al., 1996b; Holmes et al., 1996 (submitted for publication).



Table 6-13. Summary of Surface Area Studies

Study	Surface Area				Comments
	No. of Individuals	Type of Surface Area Measurement	Recommended Formulae Used	Population Surveyed	
<b><u>KEY STUDIES</u></b>					
Phillips et al. (1993)	Based on data from U.S. EPA (1985): 401 individuals	NA	calculated surface area to body weight ratios	Children Adults	Developed distributions of SA/BW and calculated summary statistics for 3 age groups and the combined data set
U.S. EPA (1985)	401 individuals	Based on Gehan and George (1970)	$SA=0.0239*W^{0.517}*H^{0.417}$	Children Adults	Provides statistical distribution data for total SA and SA of body parts
<b><u>RELEVANT STUDIES</u></b>					
AICH (1994)	Based on data from U.S. EPA (1989); Brainard et al. (1991); Brorby and Finley (1993)	@Risk simulation software	Various	Adults Children	Distribution data for: adult men and women and both sexes combined; total skin area, children 8-18 years; exposed skin area (hands and forearms); head; upper body
Murray and Burmaster (1992)	Based on data from U.S. EPA (1985): N = 401; Dubois and Dubois (1976): N = 9; Boyd (1935): N = 231; Costeff (1966): N = 220	Calculated based on regression equation using the data of U.S. EPA (1985)	Various	Children Adults	Analysis of and comparison of four models developed by Dubois & Dubois (1916), Boyd (1935), U.S. EPA (1985), and Costeff (1966). Presents frequency distributions



Surface Area	Central Tendency	Upper Percentile	Multiple Percentiles
<b>Adults</b>			
Whole body and body parts	see Tables 6-4 and 6-5	see Tables 6-2 and 6-3	see Tables 6-2 and 6-3
Bathing/swimming	20,000 cm <sup>2</sup>	23,000 cm <sup>2</sup>	---
Outdoor soil contact	5,000 cm <sup>2</sup>	5,800 cm <sup>2</sup>	---
<b>Children</b>			
Whole body	---	see Tables 6-6 and 6-7	see Tables 6-6 and 6-7
Body parts	---	see Table 6-8	see Table 6-8

Considerations	Rationale	Rating
<b>Study Elements</b>		
• Level of Peer Review	Studies were from peer reviewed journal articles. EPA report was peer reviewed before distribution.	High
• Accessibility	The journals used have wide circulation. EPA report available from National Technical Information Service.	High
• Reproducibility	Experimental methods are well-described.	High
• Focus on factor of interest	Experiments measured skin area directly.	High
• Data pertinent to U.S.	Experiments conducted in the U.S.	High
• Primary data	Re-analysis of primary data in more detail by two different investigators .	Low
• Currency	Neither rapidly changing nor controversial area; estimates made in 1935 deemed to be accurate and subsequently used by others.	Low
• Adequacy of data collection period	Not relevant to exposure factor; parameter not time dependent.	NA
• Validity of approach	Approach used by other investigators; not challenged in other studies.	High
• Representativeness of the population	Not statistically representative of U.S. population.	Medium
• Characterization of variability	Individual variability due to age, race, or gender not studied.	Low
• Lack of bias in study design	Objective subject selection and measurement methods used; results reproduced by others with different methods.	High
• Measurement error	Measurement variations are low; adequately described by normal statistics.	Low/Medium
<b>Other Elements</b>		
• Number of studies	1 experiment; two independent re-analyses of this data set.	Medium
• Agreement among researchers	Consistent results obtained with different analyses; but from a single set of measurements.	Medium
<b>Overall Rating</b>	This factor can be directly measured. It is not subject to dispute. Influence of age, race, or gender have not been detailed adequately in these studies.	High





Table 6-16. Recommendations for Adult Body Surface Area		
Water Contact		
Bathing and Swimming	50th	95th
	20,000 cm <sup>2</sup>	23,000 cm <sup>2</sup>
Soil Contact		
Outdoor Activities	50th	95th
	5,000 cm <sup>2</sup>	5,800 cm <sup>2</sup>
Source: U.S. EPA, 1992.		

Table 6-17. Summary of Soil Adherence Studies				
Study	Size Fraction (μm)	Soil Adherence (mg/cm <sup>2</sup> )	Population Surveyed	Comments
<u>KEY STUDIES</u>				
Kissel et al., 1995a	<150, 150-200, >250	Various	28 adults 24 children	Data presented for soil loadings by body part. See Table 6-11.
Kissel et al., 1996b	--	Various	12 children 89 adults	Data presented by activity and body part.
<u>RELEVANT STUDIES</u>				
Driver et al., 1989	<150 <250 unsieved	1.40 0.95 0.58	Adults Adults Adults	Used 5 soil types and 2-3 soil horizons (top soils and subsoils); placed soil over entire hand of test subject, excess removed by shaking the hands.
Lepow et al., 1975	--	0.5	10 children	Dirt from hands collected during play. Represents only fraction of total present, some dirt may be trapped in skin folds.
Que Hee et al., 1985	--	1.5	1 adult	Assumed exposed area = 20 cm <sup>2</sup> . Test subject was 14 years old.
Roels et al., 1980	--	0.9-1.5	661 children	Subjects lived near smelter in Brussels, Belgium. Mean amount adhering to soil was 0.159 g.
Sedman, 1989	--	0.9; 0.5	Children	Used estimate of Roels et al. (1980) and average surface of hand of an 11 year old; used estimates of Lepow et al. (1975), Roels et al. (1980), and Que Hee et al. (1985) to develop mean of 0.5 mg/cm <sup>2</sup> .
Yang et al., 1989	<150	9	Rats	Rat skin "monolayer" (i.e., minimal amount of soil covering the skin); in vitro and in vivo experiments.



Table 6-18. Confidence in Soil Adherence to Skin Recommendations

Considerations	Rationale	Rating
<b>Study Elements</b>		
• Level of Peer Review	Studies were from peer reviewed journal articles.	High
• Accessibility	Articles were published in widely circulated journals.	High
• Reproducibility	Reports clearly describe experimental method.	High
• Focus on factor of interest	The goal of the studies was to determine soil adherence to skin.	High
• Data pertinent to U.S.	Experiments were conducted in the U.S.	High
• Primary data	Experiments were directly measure soil adherence to skin; exposure and dose of chemicals in soil were measured indirectly or estimated from soil contact.	High
• Currency	New studies were presented.	High
• Adequacy of data collection period	Seasonal factors may be important, but have not been studied adequately.	Medium
• Validity of approach	Skin rinsing technique is a widely employed procedure.	High
• Representativeness of the population	Studies were limited to the State of Washington and may not be representative of other locales.	Low
• Characterization of variability	Variability in soil adherence is affected by many factors including soil properties, activity and individual behavior patterns.	Low
• Lack of bias in study design	The studies attempted to measure soil adherence in selected activities and conditions to identify important activities and groups.	High
• Measurement error	The experimental error is low and well controlled, but application of results to other similar activities may be subject to variation.	Low/High
<b>Other Elements</b>		
• Number of studies	The experiments were controlled as they were conducted by a few laboratories; activity patterns were studied by only one laboratory.	Medium
• Agreement among researchers	Results from key study were consistent with earlier estimates from relevant studies and assumptions, but are limited to hand data.	Medium
<b>Overall Rating</b>	Data are limited, therefore it is difficult to extrapolate from experiments and field observations to general conditions .	Low



**APPENDIX 6A**

**FORMULAE FOR TOTAL BODY SURFACE AREA**



**APPENDIX 6A**

**FORMULAE FOR TOTAL BODY SURFACE AREA**

Most formulae for estimating surface area (SA), relate height to weight to surface area. The following formula was proposed by Gehan and George (1970):

$$SA = KW^{2/3} \quad (\text{Eqn. 6A-1})$$

where:

- SA = surface area in square meters;
- W = weight in kg; and
- K = constant.

While the above equation has been criticized because human bodies have different specific gravities and because the surface area per unit volume differs for individuals with different body builds, it gives a reasonably good estimate of surface area.

A formula published in 1916 that still finds wide acceptance and use is that of DuBois and DuBois. Their model can be written:

$$SA = a_0 H^{a_1} W^{a_2} \quad (\text{Eqn. 6A-2})$$

where:

- SA = surface area in square meters;
- H = height in centimeters; and
- W = weight in kg.

The values of  $a_0$  (0.007182),  $a_1$  (0.725), and  $a_2$  (0.425) were estimated from a sample of only nine individuals for whom surface area was directly measured. Boyd (1935) stated that the DuBois formula was considered a reasonably adequate substitute for measuring surface area. Nomograms for determining surface area from height and mass presented in Volume I of the Geigy Scientific Tables (1981) are based on the DuBois and DuBois formula. In addition, a computerized literature search conducted for this report identified several articles written in the last 10 years in which the DuBois and DuBois formula was used to estimate body surface area.

Boyd (1935) developed new constants for the DuBois and DuBois model based on 231 direct measurements of body surface area found in the literature. These data were limited to measurements of surface area by coating methods (122 cases), surface integration (93 cases), and triangulation (16 cases). The subjects were Caucasians of normal body build for whom data on weight, height, and age (except for exact age of adults) were complete. Resulting values for the constants in the DuBois and DuBois model were  $a_0 = 0.01787$ ,  $a_1 = 0.500$ , and  $a_2 = 0.4838$ . Boyd also developed a formula based exclusively on weight, which was inferior to the DuBois and DuBois formula based on height and weight.



Gehan and George (1970) proposed another set of constants for the DuBois and DuBois model. The constants were based on a total of 401 direct measurements of surface area, height, and weight of all postnatal subjects listed in Boyd (1935). The methods used to measure these subjects were coating (163 cases), surface integration (222 cases), and triangulation (16 cases).

Gehan and George (1970) used a least-squares method to identify the values of the constants. The values of the constants chosen are those that minimize the sum of the squared percentage errors of the predicted values of surface area. This approach was used because the importance of an error of 0.1 square meter depends on the surface area of the individual. Gehan and George (1970) used the 401 observations summarized in Boyd (1935) in the least-squares method. The following estimates of the constants were obtained:  $a_0 = 0.02350$ ,  $a_1 = 0.42246$ , and  $a_2 = 0.51456$ . Hence, their equation for predicting surface area (SA) is:

$$SA = 0.02350 H^{0.42246} W^{0.51456} \quad (\text{Eqn. 6A-3})$$

or in logarithmic form:

$$\ln SA = -3.75080 + 0.42246 \ln H + 0.51456 \ln W \quad (\text{Eqn. 6A-4})$$

where:

SA = surface area in square meters;  
H = height in centimeters; and  
W = weight in kg.

This prediction explains more than 99 percent of the variations in surface area among the 401 individuals measured (Gehan and George, 1970).

The equation proposed by Gehan and George (1970) was determined by the U.S. EPA (1985) as the best choice for estimating total body surface area. However, the paper by Gehan and George gave insufficient information to estimate the standard error about the regression. Therefore, the 401 direct measurements of children and adults (i.e., Boyd, 1935) were reanalyzed in U.S. EPA (1985) using the formula of Dubois and Dubois (1916) and the Statistical Processing System (SPS) software package to obtain the standard error.

The Dubois and Dubois (1916) formula uses weight and height as independent variables to predict total body surface area (SA), and can be written as:

$$SA_i = a_0 H_i^{a_1} W_i^{a_2} e_i \quad (\text{Eqn. 6A-5})$$

or in logarithmic form:

$$\ln (SA)_i = \ln a_0 + a_1 \ln H_i + a_2 \ln W_i + \ln e_i \quad (\text{Eqn. 6A-6})$$

where:

Sai = surface area of the i-th individual (m<sup>2</sup>);  
Hi = height of the i-th individual (cm);  
Wi = weight of the i-th individual (kg);  
 $a_0$ ,  $a_1$ , and  $a_2$  = parameters to be estimated; and  
 $e_i$  = a random error term with mean zero and constant variance.



**Appendix 6A**

Using the least squares procedure for the 401 observations, the following parameter estimates and their standard errors were obtained:

$$a_0 = -3.73 (0.18), \quad a_1 = 0.417 (0.054), \quad a_2 = 0.517 (0.022)$$

The model is then:

$$SA = 0.0239 H^{0.417} W^{0.517} \tag{Eqn. 6A-7}$$

or in logarithmic form:

$$\ln SA = -3.73 + 0.417 \ln H + 0.517 \ln W \tag{Eqn. 6A-8}$$

with a standard error about the regression of 0.00374. This model explains more than 99 percent of the total variation in surface area among the observations, and is identical to two significant figures with the model developed by Gehan and George (1970).

When natural logarithms of the measured surface areas are plotted against natural logarithms of the surface predicted by the equation, the observed surface areas are symmetrically distributed around a line of perfect fit, with only a few large percentage deviations. Only five subjects differed from the measured value by 25 percent or more. Because each of the five subjects weighed less than 13 pounds, the amount of difference was small. Eighteen estimates differed from measurements by 15 to 24 percent. Of these, 12 weighed less than 15 pounds each, 1 was overweight (5 feet 7 inches, 172 pounds), 1 was very thin (4 feet 11 inches, 78 pounds), and 4 were of average build. Since the same observer measured surface area for these 4 subjects, the possibility of some bias in measured values cannot be discounted (Gehan and George 1970).

Gehan and George (1970) also considered separate constants for different age groups: less than 5 years old, 5 years old to less than 20 years old, and greater than 20 years old. The different values for the constants are presented below:

Table 6A-1. Estimated Parameter Values for Different Age Intervals

Age group	Number of persons	$a_0$	$a_1$	$a_2$
All ages	401	0.02350	0.42246	0.51456
<5 years old	229	0.02667	0.38217	0.53937
≥ 5 - <20 years old	42	0.03050	0.35129	0.54375
≥ 20 years old1	30	0.01545	0.54468	0.46336

The surface areas estimated using the parameter values for all ages were compared to surface areas estimated by the values for each age group for subjects at the 3rd, 50th, and 97th percentiles of weight and height. Nearly all differences in surface area estimates were less than 0.01 square meter, and the largest difference was 0.03 m<sup>2</sup> for an 18-year-old at the 97th percentile. The authors concluded that there is no advantage in using separate values of  $a_0$ ,  $a_1$ , and  $a_2$  by age interval.



Haycock et al. (1978) without knowledge of the work by Gehan and George (1970), developed values for the parameters  $a_0$ ,  $a_1$ , and  $a_2$  for the DuBois and DuBois model. Their interest in making the DuBois and DuBois model more accurate resulted from their work in pediatrics and the fact that DuBois and DuBois (1916) included only one child in their study group, a severely undernourished girl who weighed only 13.8 pounds at age 21 months. Haycock et al. (1978) used their own geometric method for estimating surface area from 34 body measurements for 81 subjects. Their study included newborn infants (10 cases), infants (12 cases), children (40 cases), and adult members of the medical and secretarial staffs of 2 hospitals (19 cases). The subjects all had grossly normal body structure, but the sample included subjects of widely varying physique ranging from thin to obese. Black, Hispanic, and white children were included in their sample. The values of the model parameters were solved for the relationship between surface area and height and weight by multiple regression analysis. The least squares best fit for this equation yielded the following values for the three coefficients:  $a_0 = 0.024265$ ,  $a_1 = 0.3964$ , and  $a_2 = 0.5378$ . The result was the following equation for estimating surface area:

$$SA = 0.024265 H^{0.3964} W^{0.5378} \tag{Eqn. 6A-9}$$

expressed logarithmically as:

$$\ln SA = \ln 0.024265 + 0.3964 \ln H + 0.5378 \ln W \tag{Eqn. 6A-10}$$

The coefficients for this equation agree remarkably with those obtained by Gehan and George (1970) for 401 measurements.

George et al. (1979) agree that a model more complex than the model of DuBois and DuBois for estimating surface area is unnecessary. Based on samples of direct measurements by Boyd (1935) and Gehan and George (1970), and samples of geometric estimates by Haycock et al. (1978), these authors have obtained parameters for the DuBois and DuBois model that are different than those originally postulated in 1916. The DuBois and DuBois model can be written logarithmically as:

$$\ln SA = \ln a_0 + a_1 \ln H + a_2 \ln W \tag{Eqn. 6A-11}$$

The values for  $a_0$ ,  $a_1$ , and  $a_2$  obtained by the various authors discussed in this section are presented to follow:

Table 6A-2. Summary of Surface Area Parameter Values for the DuBois and DuBois Model

Author (year)	Number of persons	$a_0$	$a_1$	$a_2$
DuBois and DuBois (1916)	9	0.007184	0.725	0.425
Boyd (1935)	231	0.01787	0.500	0.4838
Gehan and George (1970)	401	0.02350	0.42246	0.51456
Haycock et al. (1978)	81	0.024265	0.3964	0.5378

The agreement between the model parameters estimated by Gehan and George (1970) and Haycock et al. (1978) is remarkable in view of the fact that Haycock et al. (1978) were unaware of the previous work. Haycock et al. (1978) used an entirely different set of subjects, and used geometric estimates of surface area rather than direct measurements. It has been determined that the Gehan and George model is the formula of choice for estimating total surface area of the body since it is based on the largest number of direct measurements.



---

*Appendix 6A*

---

Nomograms

Sendroy and Cecchini (1954) proposed a graphical method whereby surface area could be read from a diagram relating height and weight to surface area. However, they do not give an explicit model for calculating surface area. The graph was developed empirically based on 252 cases, 127 of which were from the 401 direct measurements reported by Boyd (1935). In the other 125 cases the surface area was estimated using the linear method of DuBois and DuBois (1916). Because the Sendroy and Cecchini method is graphical, it is inherently less precise and less accurate than the formulae of other authors discussed above.



## TABLE OF CONTENTS

	<u>Page No.</u>
7. BODY WEIGHT STUDIES .....	1
7.1. KEY BODY WEIGHT STUDY .....	1
7.2. RELEVANT BODY WEIGHT STUDIES .....	4
7.3. RECOMMENDATIONS .....	10
<b>7.4. REFERENCES FOR CHAPTER 7 .....</b>	<b>11</b>



**7. BODY WEIGHT STUDIES**

There are several physiological factors needed to calculate potential exposures. These include skin surface area (see Volume I, Section 6), inhalation rate (see Volume I, Section 5) life expectancy (see Volume I, Section 8), and body weight. The average daily dose is typically normalized to the average body weight of the exposed population. If exposure occurs only during childhood years, the average child body weight during the exposure period should be used to estimate risk (U.S. EPA, 1989). Conversely, if adult exposures are being evaluated, an adult body weight value should be used.

The purpose of this section is to describe published studies on body weight for the general U.S. population. The studies have been classified as either key or relevant studies, based on the criteria described in Volume I, Section 1.3.1. Recommended values are based on the results of key studies, but relevant studies are also presented to provide the reader with added perspective on the current state of knowledge pertaining to body weight.

**7.1. KEY BODY WEIGHT STUDY**

*Hamill et al. (1979) - Physical Growth: National Center for Health Statistics Percentiles - A National*

Center for Health Statistics (NCHS) Task Force that included academic investigators and representatives from CDC Nutrition Surveillance Program selected, collated, integrated, and defined appropriate data sets to generate growth curves for the age interval: birth to 36 months developed (Hamill et al., 1979). The percentile curves were for assessing the physical growth of children in the U.S. They are based on accurate measurements made on large nationally representative samples of children (Hamill et al., 1979). Smoothed percentile curves were derived for body weight by age (Hamill et al., 1979). Curves were developed for boys and for girls. The data used to construct the curves were provided by the Fels Research Institute, Yellow Springs, Ohio. These data were from an ongoing longitudinal study where anthropometric data from direct measurements are collected regularly from participants (~1,000) in various areas of the U.S. The NCHS used advanced statistical and computer technology to generate the growth curves. Table 7-1 presents the percentiles of weight by sex and age. Figures 7-1 and 7-2 present weight by age percentiles for boys and for girls aged birth to 36 months, respectively. Limitations of this study are that mean body weight values were not reported and the data are more

Table 7-1. Smoothed Percentiles of Weight (in kg) by Sex and Age: Statistics from NCHS and Data from Fels Research Institute, Birth to 36 Months							
Sex and Age	Smoothed <sup>a</sup> Percentile						
	5th	10th	25th	50th	75th	90th	95th
Weight in Kilograms							
<b>Male</b>							
Birth	2.54	2.78	3.00	3.27	3.64	3.82	4.15
1 Month	3.16	3.43	3.82	4.29	4.75	5.14	5.38
3 Months	4.43	4.78	5.32	5.98	6.56	7.14	7.37
6 Months	6.20	6.61	7.20	7.85	8.49	9.10	9.46
9 Months	7.52	7.95	8.56	9.18	9.88	10.49	10.93
12 Months	8.43	8.84	9.49	10.15	10.91	11.54	11.99
18 Months	9.59	9.92	10.67	11.47	12.31	13.05	13.44
24 Months	10.54	10.85	11.65	12.59	13.44	14.29	14.70
30 Months	11.44	11.80	12.63	13.67	14.51	15.47	15.97
36 Months	12.26	12.69	13.58	14.69	15.59	16.66	17.28
<b>Female</b>							
Birth	2.36	2.58	2.93	3.23	3.52	3.64	3.81
1 Month	2.97	3.22	3.59	3.98	4.36	4.65	4.92
3 Months	4.18	4.47	4.88	5.40	5.90	6.39	6.74
6 Months	5.79	6.12	6.60	7.21	7.83	8.38	8.73
9 Months	7.00	7.34	7.89	8.56	9.24	9.83	10.17
12 Months	7.84	8.19	8.81	9.53	10.23	10.87	11.24
18 Months	8.92	9.30	10.04	10.82	11.55	12.30	12.76
24 Months	9.87	10.26	11.10	11.90	12.74	13.57	14.08
30 Months	10.78	11.21	12.11	12.93	13.93	14.81	15.35
36 Months	11.60	12.07	12.99	13.93	15.03	15.97	16.54

<sup>a</sup> Smoothed by cubic-spline approximation.  
Source: Hamill et al., 1979.

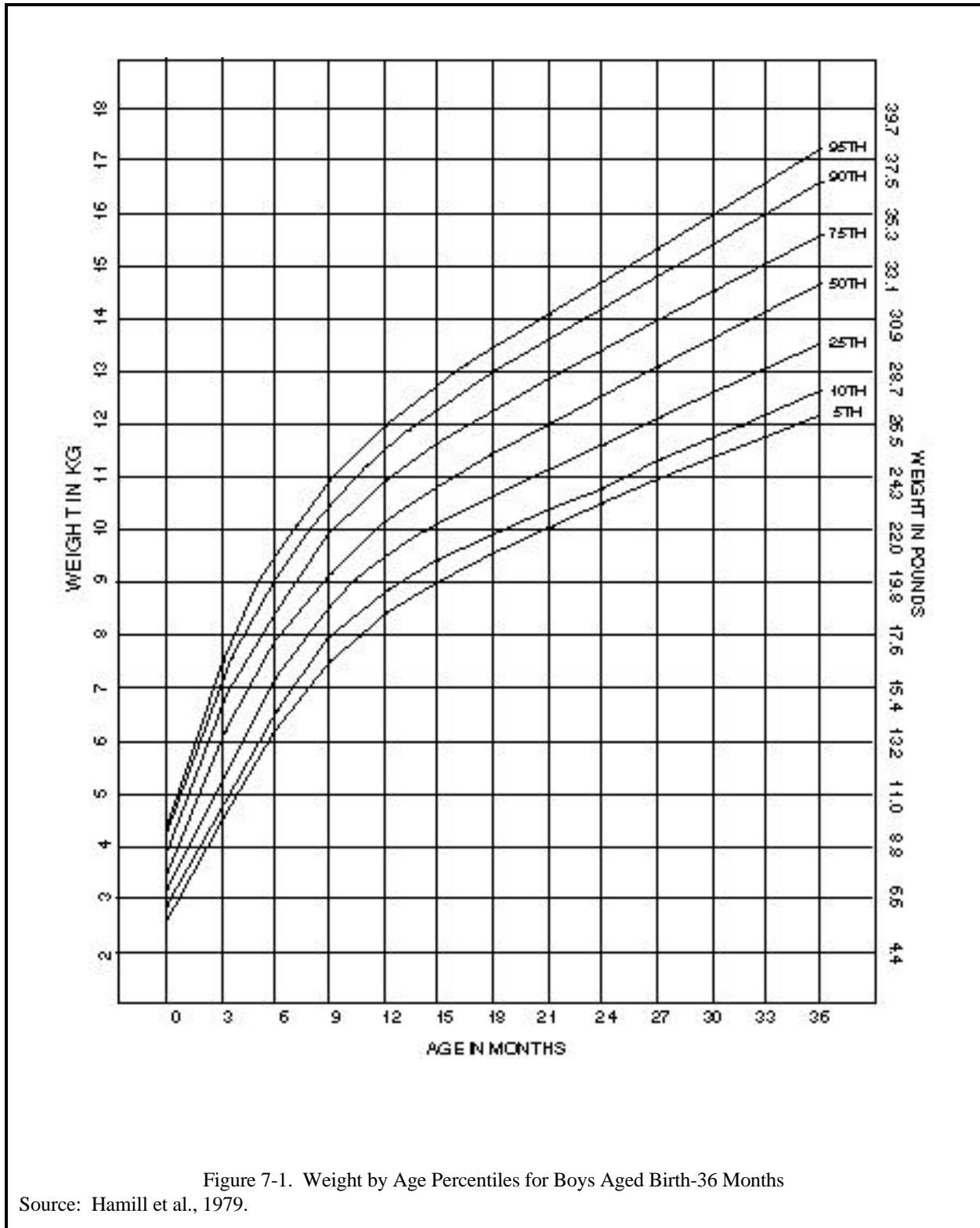

Figure 7-1. Weight by Age Percentiles for Boys Aged Birth-36 Months

Source: Hamill et al., 1979.

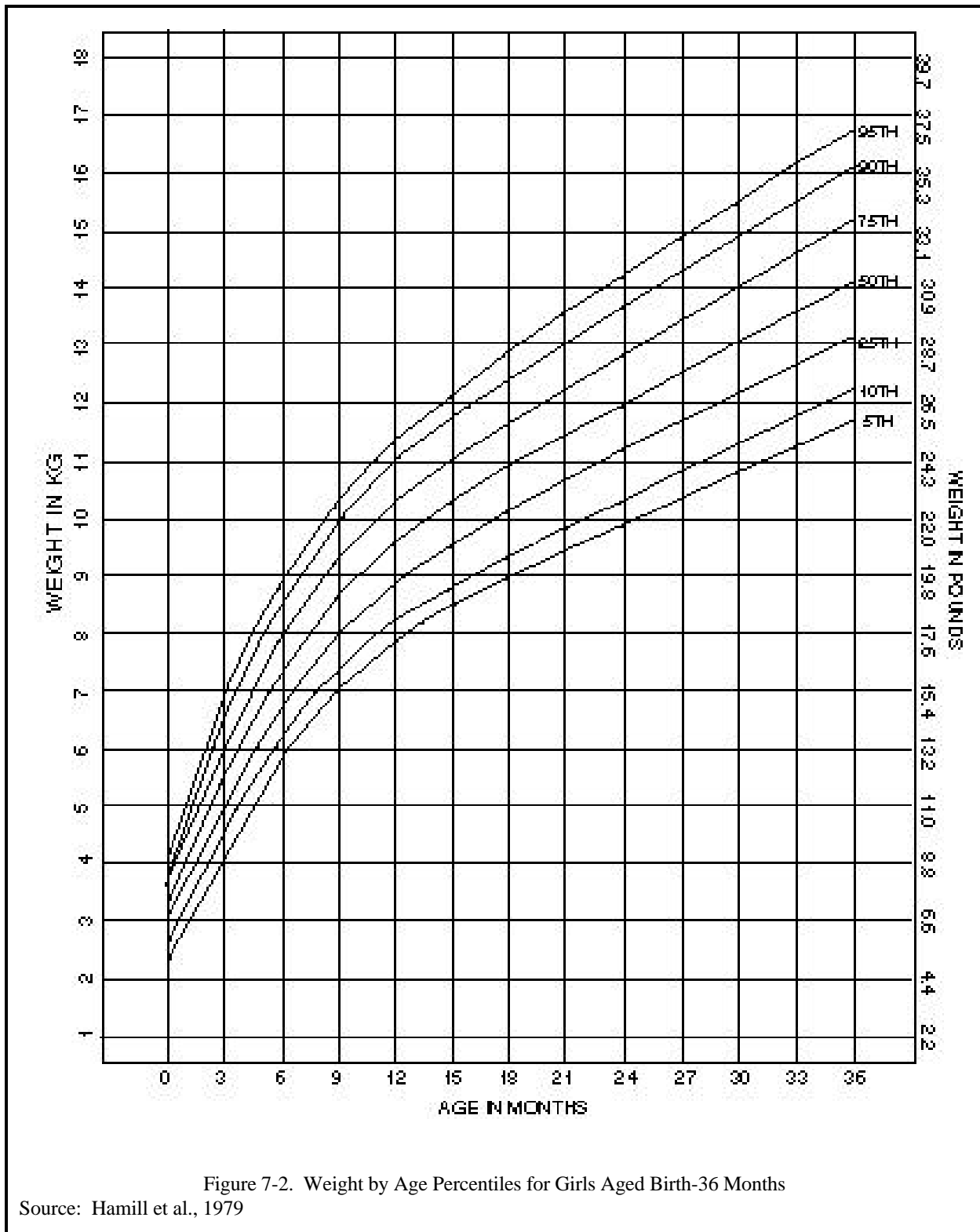

Figure 7-2. Weight by Age Percentiles for Girls Aged Birth-36 Months

Source: Hamill et al., 1979



that 15 years old. However, this study does provide body weight data for infants less than 6 months old.

NCHS (1987) - *Anthropometric Reference Data and Prevalence of Overweight, United States, 1976-80* - Statistics on anthropometric measurements, including body weight, for the U.S. population were collected by NCHS through the second National Health and Nutrition Examination Survey (NHANES II). NHANES II was conducted on a nationwide probability sample of approximately 28,000 persons, aged 6 months to 74 years, from the civilian, non-institutionalized population of the United States. Of the 28,000 persons, 20,322 were interviewed and examined, resulting in a response rate of 73.1 percent. The survey began in February 1976 and was completed in February 1980. The sample was selected so that certain subgroups thought to be at high risk of malnutrition (persons with low incomes, preschool children, and the elderly) were oversampled. The estimates were weighted to reflect national population estimates. The weighting was accomplished by inflating examination results for each subject by the reciprocal of selection probabilities adjusted to account for those who were not examined, and post stratifying by race, age, and sex (NCHS, 1987).

The NHANES II collected standard body measurements of sample subjects, including height and weight, that were made at various times of the day and in different seasons of the year. This technique was used because one's weight may vary between winter and summer and may fluctuate with recency of food and water intake and other daily activities (NCHS, 1987). Mean body weights of adults, by age, and their standard deviations are presented in Table 7-2 for men, women, and both sexes combined. Mean body weights and standard deviations for children, ages 6 months to 19 years, are presented in Table 7-3 for boys, girls, and boys and girls combined. Percentile distributions of the body weights of adults by age and race for males are presented in Table 7-4, and for females in Table 7-5. Data for children by age are presented in Table 7-6 for males, and for females in Table 7-7.

Results shown in Tables 7-4 and 7-5 indicate that the mean weight for adult males is 78.1 kg and for adult females, 65.4 kg. It also shows that the mean weight for White males (78.5 kg) is greater than for Black males (77.9 kg). Additionally, mean weights are greater for Black females (71.2 kg) than for White females (64.8 kg). From Table 7-3, the mean body weights for girls and boys are approximately the same from ages 6 months to 14 years. Starting at years 15-19, the difference in mean body weight ranges from 6 to 11 kg.

Table 7-2. Body Weights of Adults<sup>a</sup> (kilograms)

Age (years)	Men		Women		Men and Women Mean (kg)
	Mean (kg)	Std. Dev.	Mean (kg)	Std. Dev.	
18 < 25	73.8	12.7	60.6	11.9	67.2
25 < 35	78.7	13.7	64.2	15.0	71.5
35 < 45	80.9	13.4	67.1	15.2	74.0
45 < 55	80.9	13.6	68.0	15.3	74.5
55 < 65	78.8	12.8	67.9	14.7	73.4
65 < 75	74.8	12.8	66.6	13.8	70.7
18 < 75	78.1	13.5	65.4	14.6	71.8

Note: 1 kg = 2.2046 pounds.  
<sup>a</sup> Includes clothing weight, estimated as ranging from 0.09 to 0.28 kilogram.  
 Source: Adapted from National Center for Health Statistics (NCHS), 1987.

Table 7-3. Body Weights of Children<sup>a</sup> (kilograms)

Age	Boys		Girls		Boys and Girls Mean (kg)
	Mean (kg)	Std. Dev.	Mean (kg)	Std. Dev.	
6-11 months	9.4	1.3	8.8	1.2	9.1
1 year	11.8	1.9	10.8	1.4	11.3
2 years	13.6	1.7	13.0	1.5	13.3
3 years	15.7	2.0	14.9	2.1	15.3
4 years	17.8	2.5	17.0	2.4	17.4
5 years	19.8	3.0	19.6	3.3	19.7
6 years	23.0	4.0	22.1	4.0	22.6
7 years	25.1	3.9	24.7	5.0	24.9
8 years	28.2	6.2	27.9	5.7	28.1
9 years	31.1	6.3	31.9	8.4	31.5
10 years	36.4	7.7	36.1	8.0	36.3
11 years	40.3	10.1	41.8	10.9	41.1
12 years	44.2	10.1	46.4	10.1	45.3
13 years	49.9	12.3	50.9	11.8	50.4
14 years	57.1	11.0	54.8	11.1	56.0
15 years	61.0	11.0	55.1	9.8	58.1
16 years	67.1	12.4	58.1	10.1	62.6
17 years	66.7	11.5	59.6	11.4	63.2
18 years	71.1	12.7	59.0	11.1	65.1
19 years	71.7	11.6	60.2	11.0	66.0

Note: 1 kg = 2.2046 pounds.  
<sup>a</sup> Includes clothing weight, estimated as ranging from 0.09 to 0.28 kilogram.  
 Source: Adapted from National Center for Health Statistics (NCHS), 1987.

**7.2. RELEVANT BODY WEIGHT STUDIES**

*Brainard and Burmaster (1992) - Bivariate Distributions for Height and Weight of Men and Women in the United States* - Brainard and Burmaster (1992) examined data on the height and weight of adults published by the U.S. Public Health Service and fit bivariate distributions to the tabulated values for men and women, separately.

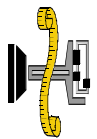

Table 7-4. Weight in Kilograms for Males 18-74 Years of Age--Number Examined, Mean, Standard Deviation, and Selected Percentiles, by Race and Age: United States, 1976-1980<sup>a</sup>

Race and Age	Number of Persons Examined	Mean (kg)	Standard Deviation	Percentile								
				5th	10th	15th	25th	50th	75th	85th	90th	95th
<u>All races<sup>b</sup></u>												
18-74 years .....	5,916	78.1	13.5	58.6	62.3	64.9	68.7	76.9	85.6	91.3	95.7	102.7
18-24 years .....	988	73.8	12.7	56.8	60.4	61.9	64.8	72.0	80.3	85.1	90.4	99.5
25-34 years .....	1,067	78.7	13.7	59.5	62.9	65.4	69.3	77.5	85.6	91.1	95.1	102.7
35-44 years .....	745	80.9	13.4	59.7	65.1	67.7	72.1	79.9	88.1	94.8	98.8	104.3
45-54 years .....	690	80.9	13.6	50.8	65.2	67.2	71.7	79.0	89.4	94.5	99.5	105.3
55-64 years .....	1,227	78.8	12.8	59.9	63.8	66.4	70.2	77.7	85.6	90.5	94.7	102.3
65-74 years .....	1,199	74.8	12.8	54.4	58.5	61.2	66.1	74.2	82.7	87.9	91.2	96.6
<u>White</u>												
18-74 years .....	5,148	78.5	13.1	59.3	62.8	65.5	69.4	77.3	85.6	91.4	95.5	102.3
18-24 years .....	846	74.2	12.8	56.8	60.5	62.0	65.0	72.4	80.6	85.5	91.0	100.0
25-34 years .....	901	79.0	13.1	59.9	63.7	65.9	69.8	78.0	85.6	91.3	95.3	102.7
35-44 years .....	653	81.4	12.8	62.3	66.6	68.8	72.9	80.1	88.2	94.6	98.7	104.1
45-54 years .....	617	81.0	13.4	62.0	66.1	67.3	71.9	79.0	89.4	94.2	99.0	104.5
55-64 years .....	1,086	78.9	12.4	60.5	64.5	66.6	70.6	78.2	85.6	90.4	94.5	101.7
65-74 years .....	1,045	75.4	12.4	55.5	59.5	62.5	67.0	74.7	83.0	87.9	91.2	96.0
<u>Black</u>												
18-74 years .....	649	77.9	15.2	58.0	61.1	63.6	67.2	75.3	85.4	92.9	98.3	105.4
18-24 years .....	121	72.2	12.0	58.3	60.9	62.3	64.9	70.8	77.1	81.8	83.7	93.6
25-34 years .....	139	78.2	16.3	58.7	63.4	64.9	68.4	75.3	84.4	90.6	92.2	106.3
35-44 years .....	70	82.5	15.4	* <sup>c</sup>	61.7	65.2	69.7	83.1	94.8	100.4	104.2	*
45-54 years .....	62	82.4	14.5	*	64.7	67.0	73.2	81.8	93.0	100.0	102.5	*
55-64 years .....	129	78.6	14.7	56.8	61.4	64.3	68.0	77.0	86.5	93.8	98.6	104.7
65-74 years .....	128	73.3	15.3	52.5	56.7	58.0	61.0	71.2	81.1	90.8	97.3	105.1

Note: 1 kg = 2.2046 pounds.

<sup>a</sup> Includes clothing weight, estimated as ranging from 0.09 to 0.28 kilogram.

<sup>b</sup> Includes all other races not shown as separate categories.

<sup>c</sup> Data not available.

Source: National Center for Health Statistics, 1987.

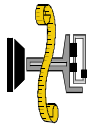

Table 7-5. Weight in Kilograms for Females 18-74 Years of Age--Number Examined, Mean, Standard Deviation, and Selected Percentiles, by Race and Age: United States, 1976-1980<sup>a</sup>

Race and Age	Number of Persons Examined	Mean (kg)	Standard Deviation	Percentile								
				5th	10th	15th	25th	50th	75th	85th	90th	95th
<u>All races<sup>b</sup></u>												
18-74 years .....	6,588	65.4	14.6	47.7	50.3	52.2	55.4	62.4	72.1	79.2	84.4	93.1
18-24 years .....	1,066	60.6	11.9	46.6	49.1	50.6	53.2	58.0	65.0	70.4	75.3	82.9
25-34 years .....	1,170	64.2	15.0	47.4	49.6	51.4	54.3	60.9	69.6	78.4	84.1	93.5
35-44 years .....	844	67.1	15.2	49.2	52.0	53.3	56.9	63.4	73.9	81.7	87.5	98.9
45-54 years .....	763	68.0	15.3	48.5	51.3	53.3	57.3	65.5	75.7	82.1	87.6	96.0
55-64 years .....	1,329	67.9	14.7	48.6	51.3	54.1	57.3	65.2	75.3	82.3	87.5	95.1
65-74 years .....	1,416	66.6	13.8	47.1	50.8	53.2	57.4	64.8	73.8	79.8	84.4	91.3
<u>White</u>												
18-74 years .....	5,686	64.8	14.1	47.7	50.3	52.2	55.2	62.1	71.1	77.9	83.3	91.5
18-24 years .....	892	60.4	11.6	47.3	49.5	50.8	53.3	57.9	64.8	69.7	74.3	82.4
25-34 years .....	1,000	63.6	14.5	47.3	49.5	51.3	54.0	60.6	68.9	76.3	81.5	89.7
35-44 years .....	726	66.1	14.5	49.3	51.8	52.9	56.3	62.4	71.9	79.7	85.8	94.9
45-54 years .....	647	67.3	14.4	48.6	51.3	53.4	57.0	65.0	74.8	81.1	85.6	94.5
55-64 years .....	1,176	67.2	14.4	48.5	50.7	53.7	57.1	64.7	74.5	81.8	86.2	92.8
65-74 years .....	1,245	66.2	13.7	47.2	50.7	52.9	57.2	64.3	72.9	79.2	84.3	91.2
<u>Black</u>												
18-74 years .....	782	71.2	17.3	48.8	51.6	55.1	59.1	67.8	80.6	87.4	94.9	105.1
18-24 years .....	147	63.1	13.9	46.2	49.0	50.6	53.8	60.4	70.0	75.8	79.1	89.3
25-34 years .....	145	69.3	16.7	48.3	50.8	53.1	57.8	65.3	80.2	87.1	91.5	102.7
35-44 years .....	103	75.3	18.4	50.7	55.2	57.2	63.0	70.2	85.2	95.3	103.5	113.1
45-54 years .....	100	77.7	18.8	55.1	60.3	60.8	64.5	74.3	83.6	94.5	98.2	117.5
55-64 years .....	135	75.8	16.4	54.2	55.2	57.6	65.4	74.6	83.4	91.9	95.5	108.5
65-74 years .....	152	72.4	13.6	52.9	56.4	60.3	64.0	70.0	82.2	84.4	86.5	98.1

Note: 1 kg = 2.2046 pounds.

<sup>a</sup> Includes clothing weight, estimated as ranging from 0.09 to 0.28 kilogram.

<sup>b</sup> Includes all other races not shown as separate categories.

Source: National Center for Health Statistics, 1987.

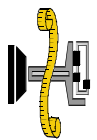

Table 7-6. Weight in Kilograms for Males 6 Months-19 Years of Age--Number Examined, Mean, Standard Deviation, and Selected Percentiles, by Sex and Age: United States, 1976-1980<sup>a</sup>

Age	Number of Persons Examined	Mean (kg)	Standard Deviation	Percentile								
				5th	10th	15th	25th	50th	75th	85th	90th	95th
6-11 months .....	179	9.4	1.3	7.5	7.6	8.2	8.6	9.4	10.1	10.7	10.9	11.4
1 years .....	370	11.8	1.9	9.6	10.0	10.3	10.8	11.7	12.6	13.1	13.6	14.4
2 years .....	375	13.6	1.7	11.1	11.6	11.8	12.6	13.5	14.5	15.2	15.8	16.5
3 years .....	418	15.7	2.0	12.9	13.5	13.9	14.4	15.4	16.8	17.4	17.9	19.1
4 years .....	404	17.8	2.5	14.1	15.0	15.3	16.0	17.6	19.0	19.9	20.9	22.2
5 years .....	397	19.8	3.0	16.0	16.8	17.1	17.7	19.4	21.3	22.9	23.7	25.4
6 years .....	133	23.0	4.0	18.6	19.2	19.8	20.3	22.0	24.1	26.4	28.3	30.1
7 years .....	148	25.1	3.9	19.7	20.8	21.2	22.2	24.8	26.9	28.2	29.6	33.9
8 years .....	147	28.2	6.2	20.4	22.7	23.6	24.6	27.5	29.9	33.0	35.5	39.1
9 years .....	145	31.1	6.3	24.0	25.6	26.0	27.1	30.2	33.0	35.4	38.6	43.1
10 years .....	157	36.4	7.7	27.2	28.2	29.6	31.4	34.8	39.2	43.5	46.3	53.4
11 years .....	155	40.3	10.1	26.8	28.8	31.8	33.5	37.3	46.4	52.0	57.0	61.0
12 years .....	145	44.2	10.1	30.7	32.5	35.4	37.8	42.5	48.8	52.6	58.9	67.5
13 years .....	173	49.9	12.3	35.4	37.0	38.3	40.1	48.4	56.3	59.8	64.2	69.9
14 years .....	186	57.1	11.0	41.0	44.5	46.4	49.8	56.4	63.3	66.1	68.9	77.0
15 years .....	184	61.0	11.0	46.2	49.1	50.6	54.2	60.1	64.9	68.7	72.8	81.3
16 years .....	178	67.1	12.4	51.4	54.3	56.1	57.6	64.4	73.6	78.1	82.2	91.2
17 years .....	173	66.7	11.5	50.7	53.4	54.8	58.8	65.8	72.0	76.8	82.3	88.9
18 years .....	164	71.1	12.7	54.1	56.6	60.3	61.9	70.4	76.6	80.0	83.5	95.3
19 years .....	148	71.7	11.6	55.9	57.9	60.5	63.8	69.5	77.9	84.3	86.8	92.1

Note: 1 kg = 2.2046 pounds.

<sup>a</sup> Includes clothing weight, estimated as ranging from 0.09 to 0.28 kilogram.

Source: National Center for Health Statistics, 1987.



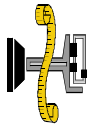

Table 7-7. Weight in Kilograms for Females 6 Months-19 Years of Age--Number Examined, Mean, Standard Deviation, and Selected Percentiles, by Sex and Age: United States, 1976-1980<sup>a</sup>

Age	Number of Persons Examined	Mean (kg)	Standard Deviation	Percentile								
				5th	10th	15th	25th	50th	75th	85th	90th	95th
6-11 months .....	177	8.8	1.2	6.6	7.3	7.5	7.9	8.9	9.4	10.1	10.4	10.9
1 years .....	336	10.8	1.4	8.8	9.1	9.4	9.9	10.7	11.7	12.4	12.7	13.4
2 years .....	336	13.0	1.5	10.8	11.2	11.6	12.0	12.7	13.8	14.5	14.9	15.9
3 years .....	366	14.9	2.1	11.7	12.3	12.9	13.4	14.7	16.1	17.0	17.4	18.4
4 years .....	396	17.0	2.4	13.7	14.3	14.5	15.2	16.7	18.4	19.3	20.2	21.1
5 years .....	364	19.6	3.3	15.3	16.1	16.7	17.2	19.0	21.2	22.8	24.7	26.6
6 years .....	135	22.1	4.0	17.0	17.8	18.6	19.3	21.3	23.8	26.6	28.9	29.6
7 years .....	157	24.7	5.0	19.2	19.5	19.8	21.4	23.8	27.1	28.7	30.3	34.0
8 years .....	123	27.9	5.7	21.4	22.3	23.3	24.4	27.5	30.2	31.3	33.2	36.5
9 years .....	149	31.9	8.4	22.9	25.0	25.8	27.0	29.7	33.6	39.3	43.3	48.4
10 years .....	136	36.1	8.0	25.7	27.5	29.0	31.0	34.5	39.5	44.2	45.8	49.6
11 years .....	140	41.8	10.9	29.8	30.3	31.3	33.9	40.3	45.8	51.0	56.6	60.0
12 years .....	147	46.4	10.1	32.3	35.0	36.7	39.1	45.4	52.6	58.0	60.5	64.3
13 years .....	162	50.9	11.8	35.4	39.0	40.3	44.1	49.0	55.2	60.9	66.4	76.3
14 years .....	178	54.8	11.1	40.3	42.8	43.7	47.4	53.1	60.3	65.7	67.6	75.2
15 years .....	145	55.1	9.8	44.0	45.1	46.5	48.2	53.3	59.6	62.2	65.5	76.6
16 years .....	170	58.1	10.1	44.1	47.3	48.9	51.3	55.6	62.5	68.9	73.3	76.8
17 years .....	134	59.6	11.4	44.5	48.9	50.5	52.2	58.4	63.4	68.4	71.6	81.8
18 years .....	170	59.0	11.1	45.3	49.5	50.8	52.8	56.4	63.0	66.0	70.1	78.0
19 years .....	158	60.2	11.0	48.5	49.7	51.7	53.9	57.1	64.4	70.7	74.8	78.1

Note: 1 kg = 2.2046 pounds.

<sup>a</sup> Includes clothing weight, estimated as ranging from 0.09 to 0.28 kilogram.

Source: National Center for Health Statistics, 1987.



Height and weight of 5,916 men and 6,588 women in the age range of 18 to 74 years were taken from the NHANES II study and statistically adjusted to represent the U.S. population aged 18 to 74 years with regard to age structure, sex, and race. Estimation techniques were used to fit normal distributions to the cumulative marginal data and goodness-of-fit tests were used to test the hypothesis that height and lognormal weight follow a normal distribution for each sex. It was found that the marginal distributions of height and lognormal weight for both men and women are Gaussian (normal) in form. This conclusion was reached by visual observation and the high  $R^2$  values for best-fit lines obtained using linear regression. The  $R^2$  values for men's height and lognormal weight are reported to be 0.999. The  $R^2$  values for women's height and lognormal weight are 0.999 and 0.985, respectively.

Brainard and Burmaster (1992) fit bivariate distributions to estimated numbers of men and women aged 18 to 74 years in cells representing 1 inch height intervals and 10 pound weight intervals. Adjusted height and lognormal weight data for men were fit to a single bivariate normal distribution with an estimated mean height of 1.75 meters (69.2 inches) and an estimated mean weight of 78.6 kg (173.2 pounds). For women, height and lognormal weight data were fit to a pair of superimposed bivariate normal distributions (Brainard and Burmaster, 1992). The average height and weight for women were estimated from the combined bivariate analyses. Mean height for women was estimated to be 1.62 meters (63.8 inches) and mean weight was estimated to be 65.8 kg (145.0 pounds). For women, a calculation using a single bivariate normal distribution gave poor results (Brainard and Burmaster, 1992). According to Brainard and Burmaster, the distributions are suitable for use in Monte Carlo simulation.

Burmaster et al. (1994) (*Submitted 2/19/94 to Risk Analysis for Publication*) - *Lognormal Distributions of Body Weight as a Function of Age for Female and Male Children in the United States* - Burmaster et al. (1994), performed data analysis to fit normal and lognormal distributions to the body weights of female and male children at age 6 months to 20 years (Burmaster et al., 1994).

Data used in this analysis were from the second survey of the National Center for Health Statistics, NHANES II, which included responses from 4,079

females and 4,379 males 6 months to 20 years of age in the U.S. (Burmaster et al., 1994). The NHANES II data had been statistically adjusted for non-response and probability of selection, and stratified by age, sex, and race to reflect the entire U.S. population prior to reporting (Burmaster et al., 1994). Burmaster et al. (1994) conducted exploratory and quantitative data analyses, and fit normal and lognormal distributions to percentiles of body weight for children. Cumulative distribution functions (CDFs) were plotted for female and male body weights on both linear and logarithmic scales.

Two models were used to assess the probability density functions (PDFs) of children's body weight. Linear and quadratic regression lines were fitted to the data. A number of goodness-of-fit measures were conducted on data generated by the two models. Burmaster et al. (1994) found that lognormal distributions give strong fits to the body weights of children, ages 6 months to 20 years. Statistics for the lognormal probability plots are presented in Tables 7-8 and 7-9. These data can be used for further analyses of body weight distribution (i.e., application of Monte Carlo analysis).

Age	Lognormal Probability Plots	
	Linear Curve	
	$\mu_2^a$	$\sigma_2^a$
6 months to 1 year	2.16	0.145
1 to 2 years	2.38	0.128
2 to 3 years	2.56	0.112
3 to 4 years	2.69	0.137
4 to 5 years	2.83	0.133
5 to 6 years	2.98	0.163
6 to 7 years	3.10	0.174
7 to 8 years	3.19	0.174
8 to 9 years	3.31	0.156
9 to 10 years	3.46	0.214
10 to 11 years	3.57	0.199
11 to 12 years	3.71	0.226
12 to 13 years	3.82	0.213
13 to 14 years	3.92	0.216
14 to 15 years	3.99	0.187
15 to 16 years	4.00	0.156
16 to 17 years	4.06	0.167
17 to 18 years	4.08	0.165
18 to 19 years	4.07	0.147
19 to 20 years	4.10	0.149

<sup>a</sup>  $\mu_2, \sigma_2$  - correspond to the mean and standard deviation, respectively, of the lognormal distribution of body weight (kg).  
Source: Burmaster et al., 1994.

Table 7-9. Statistics for Probability Plot Regression Analyses



Age	Lognormal Probability Plots Linear Curve	
	$\mu_2^a$	$\sigma_2^a$
6 months to 1 year	2.23	0.132
1 to 2 years	2.46	0.119
2 to 3 years	2.60	0.120
3 to 4 years	2.75	0.114
4 to 5 years	2.87	0.133
5 to 6 years	2.99	0.138
6 to 7 years	3.13	0.145
7 to 8 years	3.21	0.151
8 to 9 years	3.33	0.181
9 to 10 years	3.43	0.165
10 to 11 years	3.59	0.195
11 to 12 years	3.69	0.252
12 to 13 years	3.78	0.224
13 to 14 years	3.88	0.215
14 to 15 years	4.02	0.181
15 to 16 years	4.09	0.159
16 to 17 years	4.20	0.168
17 to 18 years	4.19	0.167
18 to 19 years	4.25	0.159
19 to 20 years	4.26	0.154

<sup>a</sup>  $\mu_2, \sigma_2$  - correspond to the mean and standard deviation, respectively, of the lognormal distribution of body weight (kg).  
Source: Burmaster et al., 1994.

*AIHC - Exposure Factors Sourcebook* - The Exposure Factors Sourcebook (AIHC, 1994) provides similar body weight data as presented here. Consistent with this document, an average adult body weight of 72 kg is recommended on the basis of the NHANES II data (NCHS, 1987). These data are also used to derive probability distributions for adults and children. In addition, the Sourcebook presents probability distributions derived by Brainard and Burmaster (1992), Versar (1991) and Brorby and Finley (1993). For each distribution, the @Risk formula is provided for direct use in the @Risk simulation software (Palisade, 1992). The organization of this document, makes it very convenient to use in support of Monte Carlo analysis. The reviews of the supporting studies are very brief with little analysis of their strengths and weaknesses. The Sourcebook has been classified as a relevant rather than key study because it is not the primary source for the data used to make recommendations in this document. The Sourcebook is very similar to this document in the sense that it summarizes exposure factor data and recommends values. As such, it is clearly relevant as an alternative information source on body weights as well as other exposure factors.

### 7.3. RECOMMENDATIONS

The key studies described in this section was used in selecting recommended values for body weight. The general description of both the key and relevant studies are summarized in Table 7-10. The recommendations for body weight are summarized in Table 7-11. Table 7-12 presents the confidence ratings for body weight recommendations. The mean body weight for all adults (male and female, all age groups) combined is 71.8 kg as shown in Table 7-2. The mean values for each age group in Table 7-2 were derived by adding the body weights for men and women and dividing by 2. If age and sex distribution of the exposed population is known, the mean body weight values in Table 7-2 can be used. If percentile data are needed or if race is a factor, Tables 7-4 and 7-5 can be used to select the appropriate data for percentiles or mean values.

For infants (birth to 6 months), appropriate values for body weight may be selected from Table 7-1. These data (percentile only) are presented for male and female infants.

For children, appropriate mean values for weights may be selected from Table 7-3. If percentile values are needed, these data are presented in Table 7-6 for male children and in Table 7-7 for female children.

Body weight is a function of age, gender, and race and populations of many geographic regions may vary from the general population across geographic regions. Therefore, the user should make appropriate adjustments when applying the percentiles to other geographic regions.

The mean recommended value for adults (71.8 kg) is different than the 70 kg commonly assumed in EPA risk assessments. Assessors are encouraged to use values which most accurately reflect the exposed population. When using values other than 70 kg, however, the assessors should consider if the dose estimate will be used to estimate risk by combining with a dose-response relationship which was derived assuming a body weight of 70 kg. If such an inconsistency exists, the assessor should adjust the dose-response relationship as described in the appendix to Chapter 1. The Integrated Risk Information System (IRIS) does not use a 70 kg body weight assumption in the derivation of RfCs and RfDs, but does make this assumption in the derivation of cancer slope factors and unit risks.

Table 7-10. Summary of Body Weight Studies



Study	Number of Subjects	Population	Comments
<b>KEY STUDIES</b>			
Hamill et al. (1979)	~1,000	U.S. general population	Authors noted that data are accurate measurements from a large nationally representative sample of children.
NCHS, 1987 (NHANES II)	20,322	U.S. general population	Based on civilian non-institutionalized population aged 6 months to 74 years. Response rate was 73.1 percent.
<b>RELEVANT STUDIES</b>			
Brainard and Burmaster, 1992	12,501 (5,916 men and 6,588 women)	U.S. general population	Used data from NHANES II to fit bivariate distributions to women and men age 18 to 74 years.
Burmaster et al., 1994	8,458 (4,079 females and 4,379 males)	U.S. general population	Used data from NHANES II to develop fitted distributions for children aged 6 to 20 years old. Adjusted for non-response by age, gender, and race.

Population	Mean	Upper Percentile	Multiple Percentiles
Adults	71.8 kg (See Table 7-2)	See Tables 7-4 and 7-5	See Tables 7-4 and 7-5
Children	See Table 7-3	See Tables 7-6 and 7-7	See Tables 7-6 and 7-7
Infants	Not Available	See Table 7-1	See Table 7-1

**7.4. REFERENCES FOR CHAPTER 7**

American Industrial Health Council (AIHC). (1994) Exposure factors sourcebook. AIHC, Washington, DC.

Brainard, J.; Burmaster, D. (1992) Bivariate distributions for height and weight of men and women in the United States. Risk Anal. 12(2):267-275.

Brorby, G.; Finley, G. (1993) Standard probability density functions for routine use in environmental health risk assessment. Presented at the Society of Risk Analysis Annual Meeting, December 1993, Savannah, GA.

Burmaster, D.E.; Lloyd, K.J.; Crouch, E.A.C. (1994) Lognormal distributions of body weight as a function of age for female and male children in the United States. Submitted 2/19/94 to Risk Analysis for publication.

Hamill, P.V.V.; Drizd, T.A.; Johnson, C.L.; Reed, R.B.; Roche, A.F.; Moore, W.M. (1979) Physical growth: National Center for Health Statistics Percentiles. American J. Clin. Nutr. 32:607-609.

National Center for Health Statistics (NCHS) (1987) Anthropometric reference data and prevalence of overweight, United States, 1976-80. Data from the National Health and Nutrition Examination Survey, Series 11, No. 238. Hyattsville, MD: U.S. Department of Health and Human Services, Public Health Service, National Center for Health Statistics. DHHS Publication No. (PHS) 87-1688.

Palisade. (1992) @Risk Users Guide. Palisade Corporation, Newfield, NY.

U.S. EPA (1989) Risk assessment guidance for Superfund, Volume I: Human health evaluation manual. Washington, DC: U.S. Environmental Protection Agency, Office of Emergency and Remedial Response. EPA/540/1-89/002.

Versar, Inc. (1991) Analysis of the impact of exposure assumptions on risk assessment of chemicals in the environment, phase II: uncertainty analyses of existing exposure assessment methods. Draft Report. Prepared for Exposure Assessment Task Group, Chemical Manufacturers Association, Washington, DC.



Table 7-12. Confidence in Body Weight Recommendations

Considerations	Rationale	Rating
<b>Study Elements</b>		
• Level of peer review	NHANES II was the major source of data for NCHS (1987). This is a published study which received a high level of peer review. The Hamill et al. (1979) is a peer reviewed journal publication.	High
• Accessibility	Both studies are available to the public.	High
• Reproducibility	Results can be reproduced by analyzing NHANES II data and the Fels Research Institute data.	High
• Focus on factor of interest	The studies focused on body weight, the exposure factor of interest.	High
• Data pertinent to US	The data represent the U.S. population.	High
• Primary data	The primary data were generated from NHANES II data and Fels studies, thus these data are secondary.	Medium
• Currency	The data were collected between 1976-1980.	Low
• Adequacy of data collection period	The NHANES II study included data collected over a period of 4 years. Body weight measurements were taken at various times of the day and at different seasons of the year.	High
• Validity of approach	Direct body weights were measured for both studies. For NHANES II, subgroups at risk for malnutrition were over-sampled. Weighting was accomplished by inflating examination results for those not examined and were stratified by race, age, and sex. The Fels data are from an ongoing longitudinal study where the data are collected regularly.	High
• Study size	The sample size consisted of 28,000 persons for NHANES II. Author noted in Hamill et al. (1979) that the data set was large.	High
• Representativeness of the population	Data collected focused on the U.S. population for both studies.	High
• Characterization of variability	Both studies characterized variability regarding age and sex. Additionally NHANES II characterized race (for Blacks, Whites and total populations) and sampled persons with low income.	High
• Lack of bias in study design (high rating is desirable)	There are no apparent biases in the study designs for NHANES II. The study design for collecting the Fels data was not provided.	Medium-High
• Measurement error	For NHANES II, measurement error should be low since body weights were performed in a mobile examination center using standardized procedures and equipment. Also, measurements were taken at various times of the day to account for weight fluctuations as a result of recent food or water intake. The authors of Hamill et al. (1979) report that study data are based on accurate direct measurements from an ongoing longitudinal study.	High
<b>Other Elements</b>		
• Number of studies	There are two studies.	Low
• Agreement between researchers	There is consistency among the two studies.	High
<b>Overall Rating</b>		<b>High</b>

## TABLE OF CONTENTS

	<u>Page No.</u>
8. LIFETIME .....	1
8.1. KEY STUDY ON LIFETIME .....	1
8.2. RECOMMENDATIONS .....	1
8.3. REFERENCES FOR CHAPTER 8 .....	1



## **8. LIFETIME**

The length of an individual's life is an important factor to consider when evaluating cancer risk because the dose estimate is averaged over an individual's lifetime. Since the averaging time is found in the denominator of the dose equation, a shorter lifetime would result in a higher potential risk estimate, and conversely, a longer life expectancy would produce a lower potential risk estimate.

### **8.1. KEY STUDY ON LIFETIME**

Statistical data on life expectancy are published annually by the U.S. Department of Commerce in the publication: "Statistical Abstract of the United States." The latest year for which statistics are available is 1993. Available data on life expectancies for various subpopulations born in the years 1970 to 1993 are presented in Table 8-1. Data for 1993 show that the life expectancy for an average person born in the United States in 1993 is 75.5 years (U.S. Bureau of the Census, 1995). The table shows that the overall life expectancy has averaged approximately 75 years since 1982. The average life expectancy for males in 1993 was 72.1 years, and 78.9 years for females. The data consistently show an approximate 7 years difference in life expectancy for males and females from 1970 to present. Table 8-1 also indicates that life expectancy for white males (73.0 years) is consistently longer than for Black males (64.7 years). Additionally, it indicates that life expectancy for White females (79.5 years) is longer than for Black females (73.7), a difference of almost 6 years. Table 8-2 presents data for expectation of life for persons who were at a specific age in year 1990. These data are available by age, gender, and race and may be useful for deriving exposure estimates based on the age of a specific subpopulation. The data show that expectation of life is longer for females and for Whites.

## **8.2. RECOMMENDATIONS**

Current data suggest that 75 years would be an appropriate value to reflect the average life expectancy of the general population and is the recommended value. If gender is a factor considered in the assessment, note that the average life expectancy value for females is higher than for males. It is recommended that the assessor use the appropriate value of 72.1 years for males or 78.9 years for females. If race is a consideration in assessing exposure for male individuals, note that the life expectancy is about 8 years longer for Whites than for Blacks. It is recommended that the assessor use the values of 73 years and 64.7 years for White males and Black males, respectively. Table 8-3 presents the confidence rating for life expectancy recommendations.

This recommended value is different than the 70 years commonly assumed for the general population in EPA risk assessments. Assessors are encouraged to use values which most accurately reflect the exposed population. When using values other than 70 years, however, the assessors should consider if the dose estimate will be used to estimate risk by combining with a dose-response relationship which was derived assuming a lifetime of 70 years. If such an inconsistency exists, the assessor should adjust the dose-response relationship by multiplying by (lifetime/70). The Integrated Risk Information System (IRIS) does not use a 70 year lifetime assumption in the derivation of RfCs and RfDs, but does make this assumption in the derivation of some cancer slope factors or unit risks.

## **8.3. REFERENCES FOR CHAPTER 8**

U.S. Bureau of the Census. (1995) Statistical abstracts of the United States.



Table 8-1. Expectation of Life at Birth, 1970 to 1993, and Projections, 1995 to 2010 (years)<sup>a</sup>

YEAR	TOTAL			WHITE			BLACK AND OTHER <sup>b</sup>			BLACK			
	Total	Male	Female	Total	Male	Female	Total	Male	Female	Total	Male	Female	
1970	70.8	67.1	74.7	71.7	68.0	75.6	65.3	61.3	69.4	64.1	60.0	68.3	
1975	72.6	68.8	76.6	73.4	69.5	77.3	68.0	63.7	72.4	66.8	62.4	71.3	
1980	73.7	70.0	77.4	74.4	70.7	78.1	69.5	65.3	73.6	68.1	63.8	72.5	
1981	74.1	70.4	77.8	74.8	71.1	78.4	70.3	66.2	74.4	68.9	64.5	73.2	
1982	74.5	70.8	78.1	75.1	71.5	78.7	70.9	66.8	74.9	69.4	65.1	73.6	
1983	74.6	71.0	78.1	75.2	71.6	78.7	70.9	67.0	74.7	69.4	65.2	73.5	
1984	74.7	71.1	78.2	75.3	71.8	78.7	71.1	67.2	74.9	69.5	65.3	73.6	
1985	74.7	71.1	78.2	75.3	71.8	78.7	71.0	67.0	74.8	69.3	65.0	73.4	
1986	74.7	71.2	78.2	75.4	71.9	78.8	70.9	66.8	74.9	69.1	64.8	73.4	
1987	74.9	71.4	78.3	75.6	72.1	78.9	71.0	66.9	75.0	69.1	64.7	73.4	
1988	74.9	71.4	78.3	75.6	72.2	78.9	70.8	66.7	74.8	68.9	64.4	73.2	
1989	75.1	71.7	78.5	75.9	72.5	79.2	70.9	66.7	74.9	68.8	64.3	73.3	
1990	75.4	71.8	78.8	76.1	72.7	79.4	71.2	67.0	75.2	69.1	64.5	73.6	
1991	75.5	71.0	78.9	76.3	72.9	79.6	71.5	67.3	75.5	69.3	64.6	73.8	
1992	75.8	72.3	79.1	76.5	73.2	79.8	71.8	67.7	75.7	69.6	65.0	73.9	
1993	75.5	72.1	78.9	76.3	73.0	79.5	71.5	67.4	75.5	69.3	64.7	73.7	
Projections <sup>c</sup>	1995	76.3	72.8	79.7	77.0	73.7	80.3	72.5	68.2	76.8	70.3	65.8	74.8
	2000	76.7	73.2	80.2	77.6	74.3	80.9	72.9	68.3	77.5	70.2	65.3	75.1
	2005	77.3	73.8	80.7	78.2	74.9	81.4	73.6	69.1	78.1	70.7	65.9	75.5
	2010	77.9	74.5	81.3	78.8	75.6	81.0	74.3	69.9	78.7	71.3	66.5	76.0

<sup>a</sup> Excludes deaths of nonresidents of the United States.  
<sup>b</sup> Racial descriptions were not provided in the data source.  
<sup>c</sup> Based on middle mortality assumptions; for details, see U.S. Bureau of the Census, Current Population Reports, Series P-25, No. 1104.

Source: Bureau of the Census, 1995.





Table 8-2. Expectation of Life by Race, Sex, and Age: 1992

Age in 1990 (years)	Expectation of Life in Years					
	Total	White		Black		
		Male	Female	Male	Female	
At birth	75.8	73.2	79.8	65.0	73.9	
1	75.4	72.8	79.3	65.2	74.1	
2	74.5	71.8	78.3	64.3	73.1	
3	73.5	70.9	77.3	63.4	72.2	
4	72.5	69.9	76.3	62.4	71.2	
5	71.6	68.9	75.4	61.4	70.3	
6	70.6	67.9	74.4	60.5	69.3	
7	69.6	66.9	73.4	59.5	68.3	
8	68.6	65.9	72.4	58.5	67.3	
9	67.6	65.0	71.4	57.5	66.3	
10	66.6	64.0	70.4	56.5	65.4	
11	65.6	63.0	69.4	55.5	64.4	
12	64.6	62.0	68.4	54.6	63.4	
13	63.7	61.0	67.4	53.6	62.4	
14	62.7	60.0	66.5	52.6	61.4	
15	61.7	59.1	65.5	51.7	60.4	
16	60.7	58.1	64.5	50.7	59.5	
17	59.8	57.2	63.5	49.8	58.5	
18	58.8	56.2	62.5	48.9	57.5	
19	57.9	55.3	61.6	48.1	56.6	
20	56.9	54.3	60.6	47.2	55.6	
21	56.0	53.4	59.6	46.3	54.6	
22	55.1	52.5	58.7	45.5	53.7	
23	54.1	51.6	57.7	44.6	52.7	
24	53.2	50.6	56.7	43.8	51.8	
25	52.2	49.7	55.7	42.9	50.8	
26	51.3	48.8	54.8	42.1	49.9	
27	50.4	47.8	53.8	41.2	48.9	
28	49.4	46.9	52.8	40.4	48.0	
29	48.5	46.0	51.8	39.5	47.1	
30	47.5	45.1	50.9	38.7	46.1	
31	46.6	44.1	49.9	37.8	45.2	
32	45.7	43.2	48.9	37.0	44.3	
33	44.7	42.3	48.0	36.2	43.4	
34	43.8	41.4	47.0	35.3	42.4	
35	42.9	40.5	46.0	34.5	41.5	
36	42.0	39.6	45.1	33.7	40.6	
37	41.0	38.7	44.1	32.9	39.7	
38	40.1	37.8	43.2	32.1	38.8	
39	39.2	36.9	42.2	31.3	37.9	
40	38.3	36.0	41.2	30.5	37.1	
41	37.4	35.1	40.3	29.7	36.2	
42	36.5	34.2	39.3	28.9	35.3	
43	35.6	33.3	38.4	28.2	34.4	
44	34.7	32.4	37.5	27.4	33.6	
45	33.8	31.5	36.5	26.7	32.7	
46	32.9	30.6	35.6	25.9	31.9	
47	32.0	29.7	34.7	25.2	31.0	
48	31.1	28.8	33.7	24.4	30.2	
49	30.2	28.0	32.8	23.7	29.3	

Table 8-2. Expectation of Life by Race, Sex, and Age: 1992 (continued)



Age in 1990 (years)	Expectation of Life in Years					
	Total	White		Black		
		Male	Female	Male	Female	
50	29.3	27.1	31.9	23.0	28.5	
51	28.5	26.3	31.0	22.3	27.7	
52	27.6	25.4	30.1	21.5	26.8	
53	26.8	24.6	29.2	20.8	26.0	
54	25.9	23.7	28.3	20.1	25.3	
55	25.1	22.9	27.5	19.5	24.5	
56	24.3	22.1	26.6	18.8	23.7	
57	23.5	21.3	25.7	18.2	23.0	
58	22.7	20.6	24.9	17.6	22.2	
59	21.9	19.8	24.1	16.9	21.5	
60	21.1	19.1	23.2	16.3	20.8	
61	20.4	18.3	22.4	15.8	20.1	
62	19.7	17.6	21.6	15.2	19.4	
63	18.9	16.9	20.8	14.6	18.7	
64	18.2	16.2	20.0	14.1	18.0	
65	17.5	15.5	19.3	13.5	17.4	
70	14.2	12.4	15.6	11.0	14.3	
75	11.2	9.6	12.2	8.9	11.4	
80	8.5	7.2	9.2	6.8	8.6	
85 and over	6.2	5.3	6.6	5.1	6.3	

Source: U.S. Bureau of Census, 1995.



Table 8-3. Confidence in Lifetime Expectancy Recommendations

Considerations	Rationale	Rating
<b><u>Study Elements</u></b>		
• Level of peer review	Data are published and have received extensive peer review.	High
• Accessibility	The study was widely available to the public (Census data).	High
• Reproducibility	Results can be reproduced by analyzing Census data.	High
• Focus on factor of interest	Statistical data on life expectancy were published in this study.	High
• Data pertinent to US	The study focused on the U.S. population.	High
• Primary data	Primary data were analyzed.	High
• Currency	The study was published in 1995 and discusses life expectancy trends from 1970 to 1993. The study has also made projections for 1995 until the year 2010.	High
• Adequacy of data collection period	The data analyzed were collected over a period of years.	High
• Validity of approach	Census data is collected and analyzed over a period of years.	High
• Study size	This study was based on U.S. Census data, thus the population study size is expected to be greater than 100.	High
• Representativeness of the population	The data are representative of the U.S. population.	High
• Characterization of variability	Data were averaged by gender and race but only for Blacks and Whites; no other nationalities were represented within the section.	Medium
• Lack of bias in study design (High rating is desirable)	There are no apparent biases.	High
• Measurement error	Measurement error may be attributed to portions of the population that avoid or provide misleading information on census surveys.	Medium
<b><u>Other Elements</u></b>		
• Number of studies	Data presented in the section are from the U.S. Bureau of the Census publication.	Low
• Agreement between researchers	Recommendation was based on only one study, but it is widely accepted.	High
<b>Overall Rating</b>		<b>HIGH</b>

# TABLE OF CONTENTS

	<u>Page No.</u>
9. INTAKE OF FRUITS AND VEGETABLES .....	1
9.1. BACKGROUND .....	1
9.2. INTAKE STUDIES .....	2
9.2.1. U.S. Department of Agriculture Nationwide Food Consumption Survey and Continuing Survey of Food Intake by Individuals .....	2
9.2.2. Key Fruits and Vegetables Intake Study Based on the USDA CSFII .....	2
9.2.3. Relevant Fruits and Vegetables Intake Studies .....	4
9.2.4. Relevant Fruits and Vegetables Serving Size Study Based on the USDA NFCS .....	6
9.2.5. Conversion Between As Consumed and Dry Weight Intake Rates .....	7
9.3. RECOMMENDATIONS .....	7
9.4. REFERENCES FOR CHAPTER 9 .....	8



## **9. INTAKE OF FRUITS AND VEGETABLES**

### **9.1. BACKGROUND**

Ingestion of contaminated fruits and vegetables is a potential pathway of human exposure to toxic chemicals. Fruits and vegetables may become contaminated with toxic chemicals by several different pathways. Ambient pollutants from the air may be deposited on or absorbed by the plants, or dissolved in rainfall or irrigation waters that contact the plants. Pollutants may also be absorbed through plant roots from contaminated soil and ground water. The addition of pesticides, soil additives, and fertilizers may also result in food contamination.

The primary source of information on consumption rates of fruits and vegetables among the United States population is the U.S. Department of Agriculture's (USDA) Nationwide Food Consumption Survey (NFCS) and the USDA Continuing Survey of Food Intakes by Individuals (CSFII). Data from the NFCS have been used in various studies to generate consumer-only and per capita intake rates for both individual fruits and vegetables and total fruits and total vegetables. CSFII data from the 1989-1991 survey have been analyzed by EPA to generate per capita intake rates for various food items and food groups.

Consumer-only intake is defined as the quantity of fruits and vegetables consumed by individuals who ate these food items during the survey period. Per capita intake rates are generated by averaging consumer-only intakes over the entire population of users and non-users. In general, per capita intake rates are appropriate for use in exposure assessment for which average dose estimates for the general population are of interest because they represent both individuals who ate the foods during the survey period and individuals who may eat the food items at some time, but did not consume them during the survey period. Total fruit intake refers to the sum of all fruits consumed in a day including canned, dried, frozen, and fresh fruits. Likewise, total vegetable intake refers to the sum of all vegetables consumed in a day including canned, dried, frozen, and fresh vegetables. For the purposes of this handbook, the distinctions between fruits and vegetables are those commonly used, not the botanical definitions. For example, in this report, tomatoes are considered vegetables, although technically they are fruits.

Intake rates may be presented on either an as consumed or dry weight basis. As consumed intake rates (g/day) are based on the weight of the food in the form that it is consumed. In contrast, dry weight intake rates are based on the weight of the food consumed after the moisture content has been removed. In calculating exposures based

on ingestion, the unit of weight used to measure intake should be consistent with those used in measuring the contaminant concentration in the produce. Intake data from the individual component of the NFCS and CSFII are based on "as eaten" (i.e., cooked or prepared) forms of the food items/groups. Thus, corrections to account for changes in portion sizes from cooking losses are not required.

Estimating source-specific exposures to toxic chemicals in fruits and vegetables may also require information on the amount of fruits and vegetables that are exposed to or protected from contamination as a result of cultivation practices or the physical nature of the food product itself (i.e., those having protective coverings that are removed before eating would be considered protected), or the amount grown beneath the soil (i.e., most root crops such as potatoes). The percentages of foods grown above and below ground will be useful when the concentrations of contaminants in foods are estimated from concentrations in soil, water, and air. For example, vegetables grown below ground may be more likely to be contaminated by soil pollutants, but leafy above ground vegetables may be more likely to be contaminated by deposition of air pollutants on plant surfaces.

The purpose of this section is to provide: (1) intake data for individual fruits and vegetables, and total fruits and total vegetables; (2) guidance for converting between as consumed and dry weight intake rates; and (3) intake data for exposed and protected fruits and vegetables and those grown below ground. Recommendations are based on average and upper-percentile intake among the general population of the U.S. Available data have been classified as being either a key or a relevant study based on the considerations discussed in Volume I, Section 1.3.1 of the Introduction. Recommendations are based on data from the CSFII 1989-1991 survey, which was considered the only key intake study for fruits and vegetables. Other relevant studies are also presented to provide the reader with added perspective on this topic. It should be noted that many of the relevant studies are based on data from USDA's NFCS and CSFII. The USDA NFCS and CSFII are described below.

### **9.2. INTAKE STUDIES**

#### **9.2.1. U.S. Department of Agriculture Nationwide Food Consumption Survey and Continuing Survey of Food Intake by Individuals**

USDA conducts the NFCS approximately every 10 years. The three most recent NFCSs were conducted in 1965-66, 1977-78, and 1987-88. The purpose of these



surveys was to "analyze the food consumption behavior and dietary status of Americans" (USDA, 1992a). The survey uses a statistical sampling technique designed to ensure that all seasons, geographic regions of the U.S., and demographic and socioeconomic groups are represented. There are two components of the NFCS. The household component collects information on the socioeconomic and demographic characteristics of households, and the types, value, and sources of foods consumed over a 7-day period. The individual component collects information on food intakes of individuals within each household over a 3-day period (USDA, 1992b).

The same basic survey design was used for the three most recent NFCSs, but the sample sizes and statistical classifications used were somewhat different (USDA, 1992a). In 1965-66, 10,000 households were surveyed (USDA, 1972). The sample size increased to 15,000 households (over 36,000 individuals) in 1977-78, but decreased to 4,500 households in 1987-88 because of budgetary constraints and a low response rate (37 percent). Data from the 1977-78 NFCS are presented in this handbook because the data have been published by USDA in various publications and reanalyzed by various EPA offices according to the food items/groups commonly used to assess exposure. Published 1-day data from the 1987-88 NFCS data are also presented.

USDA also conducts the Continuing Survey of Food Intake by Individuals. The purpose of the survey is to "assess food consumption behavior and nutritional content of diets for policy implications relating to food production and marketing, food safety, food assistance, and nutrition education" (USDA, 1995). An EPA analysis of the 1989-91 CSFII data set is presented in this handbook. During 1989 through 1991, over 15,000 individuals participated in the CSFII (USDA, 1995). Using a stratified sampling technique, individuals of all ages living in selected households in the 48 conterminous states and Washington, D.C. were surveyed. Individuals provided 3 consecutive days of data, including a personal interview on the first day followed by 2-day dietary records. The 3-day response rate for the 1989-91 CSFII was approximately 45 percent. Published 1-day data from the 1994 and 1995 CSFII are also presented. The 1994 and 1995 CSFII included data for 2 non-consecutive survey days (although 2 days of data have been collected, only data for the first survey day have been analyzed and published by USDA). Over 5,500 individuals participated in these surveys (USDA, 1996a; 1996b).

Individual average daily intake rates calculated from NFCS and CSFII data are based on averages of reported individual intakes over one day or three consecutive days. Such short term data are suitable for estimating mean average daily intake rates representative of both short-term and long-term consumption. However, the *distribution* of average daily intake rates generated using short term data (e.g., 3 day) do not necessarily reflect the long-term *distribution* of average daily intake rates. The distributions generated from short term and long term data will differ to the extent that each individual's intake varies from day to day; the distributions will be similar to the extent that individuals' intakes are constant from day to day.

Day to day variation in intake among individuals will be great for food item/groups that are highly seasonal and for items/groups that are eaten year around but that are not typically eaten every day. For these foods, the intake distribution generated from short term data will not be a good reflection of the long term distribution. On the other hand, for broad categories of foods (e.g., vegetables) which are eaten on a daily basis throughout the year with minimal seasonality, the short term distribution may be a reasonable approximation of the true long term distribution, although it will show somewhat more variability. In this and the following section, distributions are shown only for the following broad categories of foods: fruits, vegetables, meats and dairy. Because of the increased variability of the short-term distribution, the short-term upper percentiles shown here will overestimate somewhat the corresponding percentiles of the long-term distribution.

### **9.2.2. Key Fruits and Vegetables Intake Study Based on the USDA CSFII**

*U.S. EPA Analysis of USDA 1989-91 CSFII Data* - EPA analyzed three years of data from USDA's CSFII to generate distributions of intake rates for various fruit and vegetable items/groups. Data from the 1989, 1990, and 1991 CFSII were combined into a single data set to increase the number of observations available for analysis. Approximately 15,000 individuals provided intake data over the three survey years. The fruit and vegetable items/groups selected for this analysis included total fruits and total vegetables; individual fruits such as: apples, peaches, pears, strawberries, and other berries; individual vegetables such as: asparagus, beets, broccoli, cabbage, carrots, corn, cucumbers, lettuce, lima beans, okra, onions, peas, peppers, pumpkin, snap beans, tomatoes, and white potatoes; fruits and vegetables categorized as exposed, protected and roots; and various USDA categories (i.e.,



---

**Chapter 9 - Intake of Fruits and Vegetables**

---

citrus and other fruits, and dark green, deep yellow, and other vegetables). These fruit and vegetable categories were selected to be consistent with those evaluated in the homegrown food analysis presented in Chapter 13. Intake rates of total vegetables, tomatoes, and white potatoes were adjusted to account for the amount of these food items eaten as meat and grain mixtures as described in Appendix 9A. Food items/groups were identified in the CSFII data base according to USDA-defined food codes. Appendix 9B presents the codes used to determine the various food groups. Intake rates for these food items/groups represent intake of all forms of the product (i.e., home produced and commercially produced).

Individual identifiers in the database were used throughout the analysis to categorize populations according to demographics. These identifiers included identification number, region, urbanization, age, sex, race, body weight, weighting factor, season, and number of days that data were reported. Distributions of intake were determined for individuals who provided data for all three days of the survey. Individuals who did not provide information on body weight, or for which identifying information was unavailable, were excluded from the analysis. Three-day average intake rates were calculated for all individuals in the database for each of the food items/groups. These average daily intake rates were divided by each individual's reported body weight to generate intake rates in units of g/kg-day. The data were also weighted according to the three-day weights provided in the 1991 CSFII. USDA sample weights are calculated to account for inherent biases in the sample selection process, and to adjust the sample population to reflect the national population. Summary statistics for individual intake rates were generated on a per capita basis. That is, both users and non-users of the food item were included in the analysis. Mean consumer only intake rates may be calculated by dividing the mean per capita intake rate by the percent of the population consuming the food item of interest. Summary statistics included are: number of weighted and unweighted observations, percentage of the population using the food item/group being analyzed, mean intake rate, standard error, and percentiles of the intake rate distribution (i.e., 0, 1, 5, 10, 25, 50, 75, 90, 95, 99, and 100th percentile). Data were provided for the total population using the food item being evaluated and for several demographic groups including: various age groups (i.e., <1, 1-2, 3-5, 6-11, 12-19, 20-39, 40-69, and 70+ years); regions (i.e., Midwest, Northeast, South, and West); urbanizations (i.e., Central City, Nonmetropolitan, and Suburban; seasons (i.e., winter,

spring, summer, and fall); and races (i.e., White, Black, Asian, Native American, and other). Table 9-1 provides the codes, definitions, and a description of the data in these categories. The total numbers of individuals in the data set, by demographic group are presented in Table 9-2. The food analysis was accomplished using the SAS statistical programming system (SAS, 1990).

The results of this analysis are presented in Tables 9-3 and 9-4 for total fruits and total vegetables, Table 9-5 for individual fruits and vegetables, and Table 9-6 for the various USDA categories. The data for exposed/protected and root food items are presented in Tables 9-7 through 9-11. These tables are presented at the end of this Chapter. The results are presented in units of g/kg-day. Thus, use of these data in calculating potential dose does not require the body weight factor to be included in the denominator of the average daily dose (ADD) equation. It should be noted that converting these intake rates into units of g/day by multiplying by a single average body weight is inappropriate, because individual intake rates were indexed to the reported body weights of the survey respondents. However, if there is a need to compare the intake data presented here to intake data in units of g/day, a body weight less than 70 kg (i.e., approximately 60 kg; calculated based on the number of respondents in each age category and the average body weights for these age groups, as presented in Chapter 7 of Volume I) should be used because the total survey population included children as well as adults.

The advantages of using the 1989-91 CSFII data set are that the data are expected to be generally representative of the U.S. population and that it includes data on a wide variety of food types. However, it should be noted that the survey covers only the 48 coterminous U.S. States; Hawaii, Alaska, and U.S. Territories are not included. The data set was the most recent of a series of publicly available USDA data sets (i.e., NFCS 1977-78; NFCS 1987-88; CSFII 1989-91) at the time that EPA conducted the analysis for this handbook, and should reflect recent eating patterns in the United States. The data set includes three years of intake data combined. However, the 1989-91 CSFII data are based on a three day survey period. Short-term dietary data may not accurately reflect long-term eating patterns. This is particularly true for the tails (extremes) of the distribution of food intake. In addition, the adjustment for including mixtures adds uncertainty to the intake rate distributions. The calculation for including mixtures assumes that intake of any mixture includes all of the foods identified in Appendix Table 9A-1 in the proportions



specified in that table. This may under- or over-estimate intake of certain foods among some individuals.

The data presented in this handbook for the USDA 1989-91 CSFII is not the most up-to-date information on food intake. USDA has recently made available the data from its 1994 and 1995 CSFII. Over 5,500 people nationwide participated in both of these surveys, providing recalled food intake information for 2 separate days. Although the 2-day data analysis has not been conducted, USDA published the results for the respondents' intakes on the first day surveyed (USDA, 1996a; 1996b). USDA 1996 survey data will be made available later in 1997. As soon as 1996 data are available, EPA will take steps to get the 3-year data (1994, 1995, and 1996) analyzed and the food ingestion factors updated. Meanwhile, Table 9-12 presents a comparison of the mean daily intakes per individual in a day for fruits and vegetables from the USDA survey data from years 1977-78, 19887-88, 1989-91, 1994, and 1995. This table shows that food consumption patterns have changed for fruits when comparing 1977 and 1995 data. Consumption of fruits increased by 72 percent, but vegetable intake remained relatively constant, when comparing data from 1977 and 1995. However, only an 11 percent increase was observed when comparing fruit intake values from 1989-91 with the most recent data from 1994 and 1995. This indicates that the 1989-91 CSFII data are probably adequate for assessing ingestion exposure for current populations.

### **9.2.3. Relevant Fruits and Vegetables Intake Studies**

*The U.S. EPA's Dietary Risk Evaluation System (DRES) - USEPA, Office of Pesticide Programs - The U.S. EPA, Office of Pesticide Programs (OPP) uses the Dietary Risk Evaluation System (formerly the Tolerance Assessment System) to assess the dietary risk of pesticide use as part of the pesticide registration process. OPP sets tolerances for specific pesticides on raw agricultural commodities based on estimates of dietary risk. These estimates are calculated using pesticide residue data for the food item of concern and relevant consumption data. Intake rates are based primarily on the USDA 1977-78 NFCS although intake rates for some food items are based on estimations from production volumes or other data (i.e., some items were assigned an arbitrary value of 0.000001 g/kg-day) (Kariya, 1992). OPP has calculated per capita intake rates of individual fruits and vegetables for 22 subgroups (age, regional, and seasonal) of the population by determining the composition of NFCS food items and*

disaggregating complex food dishes into their component raw agricultural commodities (RACs) (White et al., 1983).

The DRES per capita, as consumed intake rates for all age/sex/demographic groups combined are presented in Table 9-13. These data are based on both consumers and non consumers of these food items. Data for specific subgroups of the population are not presented here, but are available through OPP via direct request. The data in Table 9-13 may be useful for estimating the risks of exposure associated with the consumption of individual fruits and vegetables. It should be noted that these data are indexed to the reported body weights of the survey respondents and are expressed in units of grams of food consumed per kg bodyweight per day. Consequently, use of these data in calculating potential dose does not require the body weight factor in the denominator of the ADD equation. It should also be noted that conversion of these intake rates into units of g/day by multiplying by a single average body weight is not appropriate because the DRES data base did not rely on a single body weight for all individuals. Instead, DRES used the body weights reported by each individual surveyed to estimate consumption in units of g/kg-day.

The advantages of using these data are that complex food dishes have been disaggregated to provide intake rates for a very large number of fruits and vegetables. These data are also based on the individual body weights of the respondents. Therefore, the use of these data in calculating exposure to toxic chemicals may provide more representative estimates of potential dose per unit body weight. However, because the data are based on NFCS short-term dietary recall the same limitations discussed previously for other NFCS data sets also apply here. In addition, consumption patterns may have changed since the data were collected in 1977-78. OPP is in the process of translating consumption information from the USDA CSFII 1989-91 survey to be used in DRES.

*Food and Nutrient Intakes of Individuals in One Day in the U.S., USDA (1980, 1992b, 1996a, 1996b) - USDA calculated mean intake rates for total fruits and total vegetables using NFCS data from 1977-78 and 1987-88 (USDA, 1980; USDA, 1992b) and CSFII data from 1994 and 1995 (USDA, 1996a; 1996b). The mean per capita total intake rates are presented in Tables 9-14 and 9-15 for fruits and Tables 9-16 and 9-17 for vegetables. These values are based on intake data for one day from the 1977-78 and 1987-88 USDA NFCSs, respectively. Data from both surveys are presented here to demonstrate that although the 1987-88 survey had fewer respondents, the mean per capita intake rates for all individuals are in good*





---

**Chapter 9 - Intake of Fruits and Vegetables**

---

agreement with the earlier survey. Also, slightly different age classifications were used in the two surveys providing a wider range of age categories from which exposure assessors may select appropriate intake rates. Tables 9-18 and 9-19 present similar data from the 1994 and 1995 CSFII. The age groups used in this data set are the same as those used in the 1987-88 NFCS. Tables 9-14 through 9-19 include both per capita intake rates and intake rates for consumers-only for various ages of individuals. Intake rates for consumers-only were calculated by dividing the per capita consumption rate by the fraction of the population using vegetables or fruits in a day. The average per capita vegetable intake rate is 201 g/day based on the 1977-78 data (USDA, 1980), 182 g/day based on the 1987-88 data (USDA, 1992b), 186 g/day based on the 1994 data, and 188 g/day based on the 1995 data. For fruits the average per capita intake rate is 142 g/day based on the two most recent USDA NFCSs (USDA, 1980; USDA, 1992b), and 171 g/day and 173 g/day based on the 1994 and 1995 CSFII, respectively (USDA, 1996a, 1996b). One-day per capita intake data for fats or oils from the 1994 and 1995 CSFII surveys are presented in Table 9-20. This total fats and oils food category includes table and cooking fats, vegetable oils, salad dressings, nondairy cream substitutes, and sauces such as tartar sauce that are mainly fat or oil (USDA, 1996a). It does not include oils or fats that were ingredients in food mixtures.

The advantages of using these data are that they provide intake estimates for all fruits, all vegetables, or all fats combined. Again, these estimates are based on one-day dietary data which may not reflect usual consumption patterns.

*U.S. EPA - Office of Radiation Programs* - The U.S. EPA Office of Radiation Programs (ORP) has also used the USDA 1977-78 NFCS to estimate daily food intake (U.S. EPA, 1984a; 1984b). ORP uses food consumption data to assess human intake of radionuclides in foods. The 1977-78 NFCS data have been reorganized by ORP, and food items have been classified according to the characteristics of radionuclide transport. Data for selected agricultural products are presented in Table 9-21 and Table 9-22. These data represent per capita, as consumed intake rates for total, leafy, exposed, and protected produce. Exposed produce refers to products (e.g., apples, pears, berries, etc.) that can intercept atmospherically deposited materials. The term protected refers to products (e.g., citrus fruit, carrots, corn, etc.) that are protected from deposition from the atmosphere. Although the fruit and vegetable classifications used in the study are somewhat limited in number, they

provide alternative food categories that may be useful to exposure assessors. Because this study was based on the USDA NFCS, the limitations discussed previously regarding short-term dietary recall data also apply to the intake rates reported here. Also, consumption patterns may have changed since the data were collected in 1977-78.

*U.S. EPA - Office of Science and Technology* - The U.S. EPA Office of Science and Technology (OST) within the Office of Water (formerly the Office of Water Regulations and Standards) used data from the FDA revision of the Total Diet Study Food Lists and Diets (Pennington, 1983) to calculate food intake rates (U.S. EPA, 1989). OST uses these consumption data in its risk assessment model for land application of municipal sludge. The FDA data used are based on the combined results of the USDA 1977-78, NFCS and the second National Health and Nutrition Examination Survey (NHANES II), 1976-80 (U.S. EPA, 1989). Because food items are listed as prepared complex foods in the FDA Total Diet Study, each item was broken down into its component parts so that the amount of raw commodities consumed could be determined. Table 9-23 presents intake rates of various fruit and vegetable categories for various age groups and estimated lifetime ingestion rates that have been derived by U.S. EPA. Note that these are per capita intake rates tabulated as grams dry weight/day. Therefore, these rates differ from those in the previous tables because U.S. EPA (1984a, 1984b) report intake rates on an as consumed basis.

The EPA-OST analysis provides intake rates for additional food categories and estimates of lifetime average daily intake on a per capita basis. In contrast to the other analyses of USDA NFCS data, this study reports the data in terms of dry weight intake rates. Thus, conversion is not required when contaminants are to be estimated on a dry weight basis. These data, however, may not reflect current consumption patterns because they are based on data from 1977-78.

*Canadian Department of National Health and Welfare Nutrition Canada Survey* - The Nutrition Canada Survey was conducted between 1970 and 1972 to "(a) examine the mean consumption of selected food groups and their contribution to nutrient intakes of Canadians, (b) examine patterns of food consumption and nutrient intake at various times of the day, and provide information on the changes in eating habits during pregnancy." (Canadian Department of National Health and Welfare, n.d.). The method used for collecting dietary intake data was 24-hour recall. The recall method relied on interview techniques in which the interviewee was asked to recall all foods and



beverages consumed during the day preceding the interview. Intake rates were reported for various age/sex groups of the population and for pregnant women (Table 9-24). The report does not specify whether the values represent per capita or consumer-only intake rates. However, they appear to be consistent with the as consumed intake rates for consumers-only reported by USDA (1980, 1992b). It should be noted that these data are also based on short-term dietary recall and are based on the Canadian population.

*USDA (1993) - Food Consumption, Prices, and Expenditures, 1970-92* - The USDA's Economic Research Service (ERS) calculates the amount of food available for human consumption in the United States on an annual basis (USDA, 1993). Supply and utilization balance sheets are generated, based on the flow of food items from production to end uses for the years 1970 to 1992. Total available supply is estimated as the sum of production and imports (USDA, 1993). The availability of food for human use commonly termed as "food disappearance" is determined by subtracting exported foods from the total available supply (USDA, 1993). USDA (1993) calculates the per capita food consumption by dividing the total food disappearance by the total U.S. population. USDA (1993) estimated per capita consumption data for various fruit and vegetable products from 1970-1992 (1992 data are published). In this section, the 1991 values, which are the most recent published final data, are presented. Retail weight per capita data are presented in Table 9-25. These data have been derived from the annual per capita values in units of pounds per year, presented by USDA (1993), by converting to units of g/day.

One of the limitations of this study is that disappearance data do not account for losses from the food supply from waste or spoilage. As a result, intake rates based on these data may overestimate daily consumption because they are based on the total quantity of marketable commodity utilized. Thus, these data represent bounding estimates of intake rates only. It should also be noted that per capita estimates based on food disappearance are not a direct measure of actual consumption or quantity ingested, instead the data are used as indicators of changes in usage over time (USDA, 1993). An advantage of this study is that it provides per capita consumption rates for fruits and vegetables that are representative of long-term intake because disappearance data are generated annually.

*AIHC, 1994 - Exposure Factors Sourcebook* - The AIHC Sourcebook (AIHC, 1994) uses the data presented in the 1989 version of the Exposure Factors Handbook which

reported data from the USDA 1977-78 NFCS. Distributions are provided in the @Risk format and the @Risk formula is also provided. In this handbook, new analyses of more recent data from the USDA 1989-91 CSFII are presented. Numbers, however, cannot be directly compared with previous values since the results from the new analysis are presented on a body weight basis.

The Sourcebook was classified as a relevant study because it was not the primary source for the data to make recommendations in this document. However, it can be used as an alternative source of information.

The advantage of using the CSFII and USDA NFCS data sets are that they are the largest publicly available data source on food intake patterns in the United States. Data are available for a wide variety of fruit and vegetable products and are intended to be representative of the U.S. population.

#### **9.2.4. Relevant Fruits and Vegetables Serving Size Study Based on the USDA NFCS**

*Pao et al. (1982) - Foods Commonly Eaten by Individuals* - Using data gathered in the 1977-78 USDA NFCS, Pao et al. (1982) calculated distributions for the quantities of individual fruit and vegetables consumed per eating occasion by members of the U.S. population (i.e., serving sizes), over a 3-day period. The data were collected during NFCS home interviews of 37,874 respondents, who were asked to recall food intake for the day preceding the interview, and record food intake the day of the interview and the day after the interview.

Serving size data are presented on an as consumed (g/day) basis. The data presented in Table 9-26 are for all ages of the population, combined. If age-specific intake data are needed, refer to Pao et al. (1982). Although serving size data only are presented in this handbook, percentiles for the average quantities of individual fruits and vegetables consumed by members of the U.S. population who had consumed these fruits and vegetables over a 3-day period can be found in Pao et al. (1982).

The advantages of using these data are that they were derived from the USDA NFCS and are representative of the U.S. population. This data set provides serving size distributions for a number of commonly eaten fruits and vegetables, but the list of foods is limited and does not account for fruits and vegetables included in complex food dishes. Also, these data represent the quantity of fruits and vegetables consumed per eating occasion. Although these estimates are based on USDA NFCS 1977-78 data, serving size data have been collected but not published for the more



Chapter 9 - Intake of Fruits and Vegetables

recent USDA surveys. These estimates may be useful for assessing acute exposures to contaminants in specific foods, or other assessments where the amount consumed per eating occasion is necessary. However, it should be noted that serving sizes may have changed since the data were collected in 1977-78.

**9.2.5. Conversion Between As Consumed and Dry Weight Intake Rates**

As noted previously, intake rates may be reported in terms of units as consumed or units of dry weight. It is essential that exposure assessors be aware of this difference so that they may ensure consistency between the units used for intake rates and those used for concentration data (i.e., if the unit of food consumption is grams dry weight/day, then the unit for the amount of pollutant in the food should be grams dry weight).

If necessary, as consumed intake rates may be converted to dry weight intake rates using the moisture content percentages presented in Table 9-27 and the following equation:

$$IR_{dw} = IR_{ac} * [(100-W)/100] \quad (\text{Eqn. 9-1})$$

"Dry weight" intake rates may be converted to "as consumed" rates by using:

$$IR_{ac} = IR_{dw} / [(100-W)/100] \quad (\text{Eqn. 9-2})$$

where:

$IR_{dw}$  = dry weight intake rate;  
 $IR_{ac}$  = as consumed intake rate; and  
 $W$  = percent water content.

**9.3. RECOMMENDATIONS**

The 1989-91 CSFII data described in this section were used in selecting recommended fruit and vegetable intake rates for the general population and various subgroups of the United States population. The general design of both key and relevant studies are summarized in Table 9-28. Table 9-29 presents a summary of the recommended values for fruit and vegetable intake and Table 9-30 presents the confidence ratings for the fruit and

vegetable intake recommendations. Based on the CSFII 1989-91, the recommended per capita fruit intake rate for the general population is 3.4 g/kg-day and the recommended per capita vegetable intake rate for the general population is 4.3 g/kg-day. Per capita intake rates for specific food items, on a g/kg-day basis, may be obtained from Table 9-5. Percentiles of the per capita intake rate distribution in the general population for total fruits and total vegetables are presented in Tables 9-3 and 9-4. From these tables, the 95th percentile intake rates for fruits and vegetables are 12 g/kg-day and 10 g/kg-day, respectively. It is important to note that the distributions presented in Tables 9-3 through 9-4 are based on data collected over a 3-day period and may not necessarily reflect the long-term distribution of average daily intake rates. However, for these broad categories of food (i.e., total fruits and total vegetables), because they are eaten on a daily basis throughout the year with minimal seasonality, the short term distribution may be a reasonable approximation of the long-term distribution, although it will display somewhat increased variability. This implies that the upper percentiles shown here will tend to overestimate the corresponding percentiles of the true long-term distribution. Intake rates for the home-produced form of these fruit and vegetable products are presented in Volume II, Chapter 13. It should be noted that because these recommendations are based on 1989-91 CSFII data, they may not reflect the most recent changes that may have occurred in consumption patterns. However, as indicated in Table 9-12, intake has remained fairly constant between 1989-91 and 1995. Thus, the 1989-91 CSFII data are believed to be appropriate for assessing ingestion exposure for current populations.

**9.4. REFERENCES FOR CHAPTER 9**

American Industrial Health Council (AIHC). (1994) Exposure factors sourcebook. AIHC, Washington, DC.

Canadian Department of National Health and Welfare, Bureau of National Sciences, Health Protection Branch (n.d.). Food Consumption, Patterns Report: A report from Nutrition Canada.

Kariya, J. (1992) Written communication to L. Phillips, Versar, Inc., March 4, 1992.

Pao, E.M.; Fleming, K.H.; Guenther, P.M.; Mickle, S.J. (1982) Foods commonly eaten by individuals: amount per day and per eating occasion. U.S.



- Department of Agriculture. Home Economics Report No. 44.
- Pennington, J.A.T. (1983) Revision of the total diet study food list and diets. *J. Am. Diet. Assoc.* 82:166-173.
- SAS Institute, Inc. (1990) SAS Procedures Guide, Version 6, Third Edition, Cary, NC: SAS Institute, Inc., 1990, 705 pp.
- USDA. (1972) Food consumption: households in the United States, Seasons and year 1965-1966. U.S. Department of Agriculture.
- USDA. (1979-1986) Agricultural Handbook No. 8. United States Department of Agriculture.
- USDA. (1980) Food and nutrient intakes of individuals in one day in the United States, Spring 1977. Nationwide Food Consumption Survey 1977-1978. U.S. Department of Agriculture. Preliminary Report No. 2.
- USDA. (1992a) Changes in food consumption and expenditures in American households during the 1980s. U.S. Department of Agriculture. Washington, D.C. Statistical Bulletin No. 849.
- USDA. (1992b) Food and nutrient intakes by individuals in the United States, 1 day, 1987-88: U.S. Department of Agriculture, Human Nutrition Information Service. Nationwide Food Consumption Survey 1987-88, NFCS Rpt. No. 87-I-1.
- USDA. (1993) Food consumption prices and expenditures (1970-1992) U.S. Department of Agriculture, Economic Research Service. Statistical Bulletin, No. 867.
- USDA. (1995) Food and nutrient intakes by individuals in the United States, 1 day, 1989-91. U.S. Department of Agriculture, Agricultural Research Service. NFS Report No. 91-2.
- USDA. (1996a) Data tables: results from USDA's 1994 Continuing Survey of Food Intakes by Individuals and 1994 Diet and Health Knowledge Survey. U.S. Department of Agriculture, Agricultural Research Service, Riverdale, MD.
- USDA. (1996b) Data tables: results from USDA's 1995 Continuing Survey of Food Intakes by Individuals and 1995 Diet and Health Knowledge Survey. U.S. Department of Agriculture, Agricultural Research Service, Riverdale, MD.
- U.S. EPA. (1984a) An estimation of the daily average food intake by age and sex for use in assessing the radionuclide intake of individuals in the general population. EPA-520/1-84-021.
- U.S. EPA. (1984b) An estimation of the daily food intake based on data from the 1977-1978 USDA Nationwide Food Consumption Survey. Washington, DC: Office of Radiation Programs. EPA-520/1-84-015.
- U.S. EPA. (1989) Development of risk assessment methodologies for land application and distribution and marketing of municipal sludge. Washington, DC: Office of Science and Technology. EPA 600/-89/001.
- White, S.B.; Peterson, B.; Clayton, C.A.; Duncan, D.P. (1983) Interim Report Number 1: The construction of a raw agricultural commodity consumption data base. Prepared by Research Triangle Institute for EPA Office of Pesticide Programs.



Table 9-1. Sub-category Codes and Definitions Used in the CSFII 1989-91 Analysis		
Code	Definition	Description
Region <sup>a</sup>		
1	Northeast	Includes Connecticut, Maine, Massachusetts, New Hampshire, New Jersey, New York, Pennsylvania, Rhode Island, and Vermont
2	Midwest	Includes Illinois, Indiana, Iowa, Kansas, Michigan, Minnesota, Missouri, Nebraska, North Dakota, Ohio, South Dakota, and Wisconsin
3	South	Includes Alabama, Arkansas, Delaware, District of Columbia, Florida, Georgia, Kentucky, Louisiana, Maryland, Mississippi, North Carolina, Oklahoma, South Carolina, Tennessee, Texas, Virginia, and West Virginia
4	West	Includes Arizona, California, Colorado, Idaho, Montana, Nevada, New Mexico, Oregon, Utah, Washington, and Wyoming
Urbanization		
1	Central City	Cities with populations of 50,000 or more that is the main city within the metropolitan statistical area (MSA).
2	Suburban	An area that is generally within the boundaries of an MSA, but is not within the legal limit of the central city.
3	Nonmetropolitan	An area that is not within an MSA.
Season		
Spring	-	April, May, June
Summer	-	July, August, September
Fall	-	October, November, December
Winter	-	January, February, March
Race		
1	--	White (Caucasian)
2	--	Black
3	--	Asian and Pacific Islander
4	--	Native American, Aleuts, and Eskimos
5, 8, 9	Other/NA	Don't know, no answer, some other race
<sup>a</sup> Alaska and Hawaii were not included. Source: CSFII 1989-91.		



Table 9-2. Weighted and Unweighted Number of Observations for 1989-91 CSFII Data Used in Analysis of Food Intake

Demographic Factor	Weighted	Unweighted
Total	242,707,000	11,912
Age		
<01	7,394,000	424
01-02	7,827,000	450
03-05	11,795,000	603
06-11	21,830,000	1,147
12-19	26,046,000	1,250
20-39	78,680,000	3,555
40-69	71,899,000	3,380
70+	17,236,000	1,103
Season		
Fall	60,633,000	3,117
Spring	60,689,000	3,077
Summer	60,683,000	2,856
Winter	60,702,000	2,862
Urbanization		
Central City	73,410,000	3,607
Nonmetropolitan	53,993,000	3,119
Suburban	115,304,000	5,186
Race		
Asian	2,871,000	149
Black	29,721,000	1,632
Native American	2,102,000	171
Other/NA	7,556,000	350
White	200,457,000	9,610
Region		
Northeast	59,285,000	3,007
Midwest	50,099,000	2,180
South	83,741,000	4,203
West	49,582,000	2,522



Table 9-3. Per Capita Intake of Total Fruits (g/kg-day as consumed)

Population Group	Percent Consuming	Mean	SE	P1	P5	P10	P25	P50	P75	P90	P95	P99	P100
<b>Total</b>	69.0%	3.381	0.068	0	0	0	0	1.68	4.16	7.98	12.44	26.54	210.72
<b>Age (years)</b>													
< 01	67.9%	14.898	1.285	0	0	0	0	8.80	21.90	35.98	42.77	88.42	210.72
01-02	76.7%	11.836	0.582	0	0	0	2.80	9.76	17.99	25.70	30.69	52.27	80.19
03-05	80.8%	8.422	0.364	0	0	0	2.22	6.37	12.53	19.29	22.78	32.83	52.87
06-11	79.2%	5.047	0.160	0	0	0	1.30	3.86	7.17	11.79	14.49	21.53	30.37
12-19	62.6%	2.183	0.095	0	0	0	0	1.36	3.38	5.66	7.24	11.80	16.86
20-39	58.8%	1.875	0.056	0	0	0	0	1.06	2.82	5.08	6.43	10.26	41.58
40-69	71.0%	2.119	0.051	0	0	0	0	1.36	3.24	5.20	6.73	10.52	23.07
70 +	83.3%	2.982	0.087	0	0	0	0.89	2.42	4.28	6.77	8.31	11.89	15.00
<b>Season</b>													
Fall	68.9%	3.579	0.169	0	0	0	0	1.66	3.94	8.20	13.41	32.62	204.28
Spring	68.3%	3.249	0.116	0	0	0	0	1.73	4.14	7.43	12.22	23.71	88.42
Summer	70.4%	3.381	0.131	0	0	0	0	1.80	4.29	7.87	12.26	23.11	210.72
Winter	68.4%	3.314	0.119	0	0	0	0	1.52	4.27	8.33	12.17	26.54	75.52
<b>Urbanization</b>													
Central City	68.8%	3.288	0.114	0	0	0	0	1.66	4.00	7.82	11.94	23.73	210.72
Nonmetropolitan	67.4%	3.107	0.113	0	0	0	0	1.51	3.94	7.52	12.25	26.04	84.34
Suburban	70.1%	3.567	0.113	0	0	0	0	1.80	4.40	8.43	13.19	28.13	204.28
<b>Race</b>													
Asian	77.2%	5.839	0.632	0	0	0	1.24	4.20	6.76	17.30	20.65	29.61	38.95
Black	63.7%	3.279	0.188	0	0	0	0	1.51	4.25	7.70	12.34	26.54	210.72
Native American	61.4%	3.319	0.490	0	0	0	0	1.58	4.31	7.57	16.02	22.66	29.24
Other/NA	64.9%	4.027	0.465	0	0	0	0	1.77	5.10	10.92	14.96	47.78	53.89
White	70.1%	3.337	0.075	0	0	0	0	1.66	4.06	7.87	12.21	26.48	204.28
<b>Region</b>													
Midwest	69.9%	3.236	0.120	0	0	0	0	1.58	4.07	7.87	11.30	28.64	84.34
Northeast	73.9%	3.665	0.143	0	0	0	0.07	1.84	4.70	8.37	12.75	31.67	88.42
South	62.0%	3.017	0.105	0	0	0	0	1.42	3.80	7.39	11.67	24.67	210.72
West	75.4%	3.880	0.187	0	0	0	0.17	2.08	4.45	9.18	14.61	25.49	204.28
NOTE: SE = Standard error P = Percentile of the distribution													
Source: Based on EPA's analyses of the 1989-91 CSFII													



Table 9-4. Per Capita Intake of Total Vegetables (g/kg-day as consumed)

Population Group	Percent Consuming	Mean	SE	P1	P5	P10	P25	P50	P75	P90	P95	P99	P100
<b>Total</b>	97.2%	4.259	0.029	0	0.75	1.29	2.26	3.60	5.37	7.93	10.00	15.65	44.99
<b>Age (years)</b>													
< 01	74.8%	6.802	0.375	0	0	0	0	5.52	10.41	15.27	19.29	29.61	44.99
01-02	95.6%	7.952	0.228	0	1.33	2.32	4.65	7.28	10.26	14.77	16.32	21.24	32.10
03-05	97.2%	7.125	0.200	0	1.11	2.15	3.79	5.83	9.64	13.87	15.43	25.09	35.56
06-11	97.6%	5.549	0.109	0	1.03	1.72	3.09	4.82	7.31	10.06	11.74	18.39	31.30
12-19	98.1%	3.807	0.070	0	0.85	1.30	2.16	3.49	4.71	6.80	8.52	12.26	27.84
20-39	98.2%	3.529	0.037	0	0.75	1.22	2.06	3.16	4.54	6.36	7.63	10.69	17.07
40-69	98.3%	3.741	0.039	0	0.85	1.34	2.19	3.43	4.94	6.56	7.78	10.91	24.51
70 +	98.3%	4.068	0.071	0	0.96	1.47	2.47	3.67	5.35	6.89	8.17	11.96	18.92
<b>Season</b>													
Fall	97.8%	4.366	0.063	0	0.86	1.31	2.28	3.56	5.28	8.33	10.52	17.95	35.56
Spring	96.9%	4.095	0.055	0	0.72	1.20	2.19	3.45	5.19	7.67	9.85	15.33	44.99
Summer	97.0%	4.181	0.059	0	0.58	1.16	2.21	3.54	5.34	7.73	9.54	15.14	41.68
Winter	97.0%	4.394	0.056	0	0.86	1.40	2.36	3.78	5.67	8.03	9.69	15.23	29.69
<b>Urbanization</b>													
Central City	97.4%	4.059	0.053	0	0.67	1.22	2.08	3.34	5.17	7.74	9.51	16.04	44.99
Nonmetropolitan	96.3%	4.450	0.060	0	0.86	1.41	2.44	3.72	5.66	8.28	10.08	16.27	35.56
Suburban	97.6%	4.296	0.044	0	0.82	1.31	2.30	3.64	5.38	7.86	10.17	15.39	41.68
<b>Race</b>													
Asian	93.3%	4.913	0.330	0	0	1.53	2.06	3.66	7.52	10.32	14.84	15.43	16.76
Black	96.1%	4.228	0.093	0	0.36	0.85	1.99	3.19	5.46	8.80	11.35	18.39	32.10
Native American	87.1%	4.880	0.277	0	0	0.58	2.40	4.22	6.85	8.87	11.37	13.89	21.77
Other/NA	96.6%	4.762	0.183	0	0	1.11	2.46	4.24	6.20	9.33	11.93	15.02	22.14
White	97.6%	4.229	0.031	0	0.86	1.37	2.30	3.60	5.32	7.74	9.75	15.31	44.99
<b>Region</b>													
Midwest	97.0%	4.123	0.061	0	0.75	1.20	2.09	3.35	5.16	8.03	9.87	16.90	35.56
Northeast	97.2%	4.494	0.073	0	0.69	1.29	2.37	3.77	5.70	8.42	11.00	15.86	41.68
South	97.4%	4.268	0.047	0	0.86	1.39	2.31	3.66	5.32	7.76	9.80	15.31	44.99
West	96.9%	4.168	0.060	0	0.60	1.22	2.25	3.57	5.38	7.78	9.53	15.28	35.56
NOTE: SE = Standard error P = Percentile of the distribution													
Source: Based on EPA's analyses of the 1989-91 CSFII													





Table 9-5. Per Capita Intake of Individual Fruits and Vegetables (g/kg-day as consumed)

Population Group	Apples			Asparagus			Bananas			Beets		
	Percent Consuming	Mean	SE	Percent Consuming	Mean	SE	Percent Consuming	Mean	SE	Percent Consuming	Mean	SE
<b>Total</b>	28.4%	0.854	0.052	1.5%	0.012	0.008	20.9%	0.27	0.02	1.8%	0.009	0.010
<b>Age (years)</b>												
< 01	41.7%	5.042	0.823	0.0%	0	0	24.3%	1.33	0.27	1.2%	0.045	0.296
01-02	42.9%	4.085	0.508	0.2%	0.003	0.041	23.3%	0.86	0.17	0.7%	0.006	0.055
03-05	44.1%	3.004	0.312	0.2%	0.001	0.038	20.1%	0.46	0.09	0.5%	0.006	0.056
06-11	41.6%	1.501	0.123	0.3%	0.001	0.019	16.2%	0.29	0.05	0.9%	0.008	0.040
12-19	23.0%	0.394	0.062	0.3%	0.003	0.033	13.3%	0.16	0.03	0.6%	0.001	0.010
20-39	21.3%	0.337	0.033	1.1%	0.008	0.012	14.4%	0.13	0.02	1.3%	0.004	0.007
40-69	26.0%	0.356	0.027	2.5%	0.025	0.016	26.0%	0.22	0.02	2.4%	0.009	0.009
70 +	30.8%	0.435	0.052	3.5%	0.026	0.028	37.4%	0.36	0.03	5.2%	0.029	0.022
<b>Season</b>												
Fall	33.7%	1.094	0.116	0.8%	0.005	0.013	19.3%	0.25	0.03	1.2%	0.009	0.040
Spring	25.9%	0.667	0.078	2.7%	0.023	0.017	21.3%	0.27	0.03	2.0%	0.009	0.012
Summer	23.2%	0.751	0.122	1.1%	0.006	0.014	20.5%	0.23	0.03	1.7%	0.005	0.008
Winter	30.4%	0.905	0.095	1.3%	0.015	0.018	22.6%	0.31	0.03	2.3%	0.011	0.013
<b>Urbanization</b>												
Central City	27.4%	0.749	0.081	1.1%	0.013	0.018	19.6%	0.25	0.03	1.3%	0.008	0.031
Nonmetropolitan	26.8%	0.759	0.104	1.3%	0.011	0.015	20.5%	0.24	0.03	1.8%	0.010	0.013
Suburban	29.9%	0.965	0.083	1.8%	0.013	0.012	21.9%	0.29	0.03	2.0%	0.008	0.009
<b>Race</b>												
Asian	38.3%	0.871	0.327	2.7%	0.067	0.123	33.6%	0.54	0.20	0.7%	0.040	0.320
Black	22.7%	0.688	0.159	0.3%	0.003	0.019	14.4%	0.19	0.04	1.1%	0.007	0.024
Native American	20.5%	0.407	0.273	0.0%	0	0	17.5%	0.36	0.16	1.2%	0.003	0.028
Other/NA	24.9%	0.964	0.256	0.6%	0.001	0.009	20.6%	0.33	0.15	0.9%	0.015	0.101
White	29.4%	0.879	0.057	1.7%	0.013	0.009	21.8%	0.27	0.02	1.9%	0.008	0.010
<b>Region</b>												
Midwest	29.1%	0.782	0.082	1.8%	0.015	0.016	18.8%	0.25	0.03	0.8%	0.010	0.049
Northeast	31.5%	0.953	0.116	1.6%	0.015	0.022	23.0%	0.26	0.04	2.3%	0.008	0.012
South	23.6%	0.828	0.099	1.0%	0.010	0.014	19.3%	0.28	0.03	1.8%	0.009	0.011
West	32.7%	0.885	0.121	1.8%	0.012	0.015	24.0%	0.27	0.03	2.4%	0.008	0.009



Table 9-5. Per Capita Intake of Individual Fruits and Vegetables (g/kg-day as consumed) (continued)

Population Group	Broccoli			Cabbage			Carrots			Corn		
	Percent Consuming	Mean	SE	Percent Consuming	Mean	SE	Percent Consuming	Mean	SE	Percent Consuming	Mean	SE
<b>Total</b>	10.9%	0.107	0.012	12.2%	0.088	0.009	16.9%	0.115	0.010	24.1%	0.206	0.010
<b>Age (years)</b>												
< 01	4.2%	0.142	0.224	2.4%	0.023	0.078	13.4%	0.379	0.165	17.5%	0.356	0.128
01-02	7.6%	0.234	0.134	5.1%	0.086	0.089	13.3%	0.214	0.085	32.9%	0.587	0.091
03-05	10.1%	0.307	0.118	7.5%	0.107	0.081	15.1%	0.148	0.052	31.5%	0.490	0.070
06-11	6.8%	0.098	0.052	7.5%	0.049	0.027	17.1%	0.154	0.037	35.8%	0.367	0.032
12-19	8.2%	0.065	0.028	8.5%	0.065	0.028	11.8%	0.056	0.018	24.0%	0.173	0.024
20-39	11.4%	0.081	0.015	10.6%	0.070	0.015	15.2%	0.076	0.013	23.8%	0.154	0.013
40-69	13.8%	0.102	0.016	17.1%	0.115	0.015	20.1%	0.120	0.016	20.4%	0.138	0.013
70 +	11.8%	0.115	0.028	21.1%	0.151	0.025	21.3%	0.132	0.022	19.0%	0.140	0.027
<b>Season</b>												
Fall	10.8%	0.089	0.024	12.3%	0.092	0.019	17.7%	0.100	0.017	23.6%	0.171	0.018
Spring	11.7%	0.122	0.022	12.4%	0.086	0.018	16.5%	0.117	0.022	24.7%	0.204	0.019
Summer	8.8%	0.120	0.032	12.3%	0.097	0.018	13.9%	0.083	0.017	24.8%	0.244	0.022
Winter	12.3%	0.098	0.020	11.9%	0.076	0.014	19.2%	0.160	0.022	23.2%	0.205	0.020
<b>Urbanization</b>												
Central City	10.6%	0.119	0.024	10.8%	0.073	0.015	15.5%	0.111	0.019	22.4%	0.182	0.017
Nonmetropolitan	9.0%	0.067	0.017	13.7%	0.102	0.016	14.4%	0.095	0.017	27.6%	0.255	0.020
Suburban	12.2%	0.119	0.019	12.4%	0.091	0.014	19.2%	0.127	0.015	23.1%	0.198	0.015
<b>Race</b>												
Asian	15.4%	0.209	0.166	27.5%	0.400	0.100	28.2%	0.177	0.101	14.1%	0.134	0.080
Black	8.3%	0.154	0.047	13.9%	0.129	0.029	7.0%	0.066	0.036	24.6%	0.226	0.028
Native American	5.3%	0.021	0.045	4.7%	0.037	0.068	11.1%	0.097	0.075	30.4%	0.373	0.099
Other/NA	10.3%	0.180	0.100	6.0%	0.041	0.044	12.9%	0.104	0.063	16.9%	0.160	0.065
White	11.4%	0.097	0.012	12.1%	0.080	0.009	18.6%	0.122	0.011	24.3%	0.204	0.011
<b>Region</b>												
Midwest	8.4%	0.077	0.025	10.1%	0.065	0.016	16.2%	0.100	0.018	26.8%	0.242	0.020
Northeast	13.5%	0.113	0.026	11.6%	0.083	0.022	19.0%	0.151	0.027	23.3%	0.208	0.026
South	9.8%	0.109	0.022	14.4%	0.106	0.015	12.4%	0.074	0.015	24.9%	0.219	0.016
West	13.4%	0.135	0.025	11.8%	0.088	0.016	23.3%	0.166	0.021	20.1%	0.138	0.018



Table 9-5. Per Capita Intake of Individual Fruits and Vegetables (g/kg-day as consumed) (continued)

Population Group	Cucumbers			Lettuce			Lima Beans			Okra		
	Percent Consuming	Mean	SE	Percent Consuming	Mean	SE	Percent Consuming	Mean	SE	Percent Consuming	Mean	SE
<b>Total</b>	15.8%	0.063	0.006	41.3%	0.224	0.006	0.9%	0.006	0.007	1.3%	0.009	0.007
<b>Age (years)</b>												
< 01	2.4%	0.021	0.107	6.8%	0.025	0.026	0.5%	0.005	0.055	0.5%	0.003	0.040
01-02	7.3%	0.062	0.069	18.2%	0.116	0.039	0.4%	0.006	0.069	0.2%	0.004	0.068
03-05	12.1%	0.083	0.046	29.4%	0.191	0.031	0.0%	0	0	0.7%	0.013	0.046
06-11	14.9%	0.086	0.032	36.3%	0.247	0.027	0.3%	0.002	0.017	0.3%	0.005	0.028
12-19	12.6%	0.050	0.017	40.4%	0.187	0.014	0.5%	0.003	0.019	1.4%	0.011	0.027
20-39	17.0%	0.057	0.009	44.4%	0.231	0.010	0.7%	0.005	0.012	1.0%	0.008	0.016
40-69	19.8%	0.070	0.008	51.0%	0.264	0.010	1.5%	0.010	0.013	1.8%	0.008	0.010
70 +	14.8%	0.055	0.016	37.4%	0.203	0.017	1.9%	0.008	0.019	2.7%	0.015	0.021
<b>Season</b>												
Fall	14.3%	0.056	0.014	38.1%	0.175	0.010	0.8%	0.004	0.010	0.9%	0.004	0.009
Spring	15.8%	0.060	0.009	43.5%	0.259	0.011	1.0%	0.008	0.015	0.8%	0.009	0.020
Summer	19.0%	0.092	0.014	42.3%	0.218	0.012	0.9%	0.006	0.014	2.2%	0.016	0.015
Winter	14.3%	0.044	0.010	41.5%	0.243	0.013	1.0%	0.007	0.013	1.3%	0.006	0.012
<b>Urbanization</b>												
Central City	15.1%	0.061	0.011	37.9%	0.196	0.009	0.5%	0.004	0.011	1.0%	0.004	0.008
Nonmetropolitan	15.1%	0.071	0.013	39.9%	0.221	0.012	1.5%	0.015	0.018	1.8%	0.013	0.015
Suburban	16.7%	0.060	0.008	44.6%	0.242	0.009	0.9%	0.004	0.007	1.2%	0.010	0.012
<b>Race</b>												
Asian	16.1%	0.065	0.036	40.3%	0.231	0.050	0.0%	0	0	4.7%	0.084	0.074
Black	7.8%	0.040	0.021	27.1%	0.134	0.014	0.9%	0.006	0.021	2.1%	0.024	0.029
Native American	6.4%	0.037	0.042	42.7%	0.146	0.034	0.0%	0	0	0.0%	0	0
Other/NA	10.9%	0.038	0.029	41.1%	0.186	0.027	0.0%	0	0	1.7%	0.004	0.023
White	17.5%	0.067	0.007	43.7%	0.239	0.007	1.0%	0.006	0.007	1.1%	0.006	0.007
<b>Region</b>												
Midwest	15.1%	0.074	0.014	36.1%	0.191	0.012	0.4%	0.005	0.019	0.2%	0	0.004
Northeast	18.9%	0.097	0.018	43.9%	0.246	0.014	0.5%	0.003	0.013	0.6%	0.009	0.031
South	13.8%	0.042	0.007	39.3%	0.210	0.009	1.8%	0.011	0.011	3.2%	0.016	0.010
West	17.2%	0.050	0.011	48.7%	0.263	0.013	0.5%	0.002	0.009	0.2%	0.005	0.022



Table 9-5. Per Capita Intake of Fruits and Vegetables (g/kg-day as consumed) (continued)

Population Group	Onions			Other Berries			Peaches			Pears		
	Percent Consuming	Mean	SE	Percent Consuming	Mean	SE	Percent Consuming	Mean	SE	Percent Consuming	Mean	SE
<b>Total</b>	17.4%	0.040	0.003	2.5%	0.029	0.017	8.6%	0.131	0.019	4.8%	0.098	0.036
<b>Age (years)</b>												
< 01	1.9%	0.004	0.022	0.9%	0.092	0.369	14.2%	0.855	0.268	12.3%	1.286	0.598
01-02	6.4%	0.012	0.017	1.3%	0.053	0.248	8.9%	0.286	0.158	2.7%	0.105	0.243
03-05	8.0%	0.023	0.016	2.2%	0.039	0.073	10.0%	0.283	0.121	4.5%	0.144	0.141
06-11	9.7%	0.033	0.015	1.4%	0.014	0.056	13.8%	0.250	0.063	7.8%	0.147	0.057
12-19	12.2%	0.030	0.010	0.8%	0.011	0.029	6.9%	0.084	0.037	3.4%	0.025	0.027
20-39	20.5%	0.040	0.005	2.3%	0.024	0.030	4.2%	0.037	0.019	2.4%	0.026	0.019
40-69	24.0%	0.054	0.005	3.2%	0.031	0.023	8.7%	0.090	0.021	5.2%	0.062	0.022
70 +	16.5%	0.043	0.012	5.1%	0.049	0.040	16.1%	0.161	0.033	7.8%	0.087	0.037
<b>Season</b>												
Fall	16.3%	0.045	0.007	2.6%	0.024	0.023	6.4%	0.113	0.043	5.5%	0.159	0.107
Spring	19.7%	0.040	0.005	1.9%	0.019	0.024	8.4%	0.107	0.037	4.3%	0.071	0.041
Summer	18.7%	0.040	0.005	3.4%	0.032	0.027	12.5%	0.166	0.033	4.2%	0.076	0.066
Winter	14.8%	0.033	0.006	2.0%	0.042	0.058	7.4%	0.136	0.041	5.1%	0.088	0.039
<b>Urbanization</b>												
Central City	16.4%	0.043	0.006	2.9%	0.033	0.030	7.3%	0.121	0.035	4.5%	0.120	0.091
Nonmetropolitan	15.7%	0.033	0.005	1.6%	0.016	0.019	9.8%	0.156	0.034	5.4%	0.083	0.033
Suburban	19.1%	0.041	0.004	2.7%	0.033	0.028	8.8%	0.125	0.029	4.6%	0.092	0.050
<b>Race</b>												
Asian	20.8%	0.090	0.042	2.7%	0.014	0.057	6.7%	0.202	0.235	2.7%	0.053	0.151
Black	9.6%	0.034	0.014	0.9%	0.008	0.034	5.6%	0.111	0.053	2.9%	0.066	0.056
Native American	5.3%	0.018	0.022	2.3%	0.072	0.165	9.9%	0.192	0.158	1.2%	0.003	0.053
Other/NA	15.1%	0.057	0.022	0.9%	0.015	0.069	4.3%	0.118	0.145	5.1%	0.063	0.089
White	19.0%	0.039	0.003	2.8%	0.033	0.019	9.3%	0.132	0.021	5.2%	0.106	0.042
<b>Region</b>												
Midwest	13.8%	0.033	0.006	2.3%	0.022	0.020	9.6%	0.155	0.040	6.0%	0.121	0.054
Northeast	20.6%	0.057	0.009	3.2%	0.023	0.024	9.0%	0.132	0.048	5.7%	0.108	0.064
South	17.2%	0.034	0.004	1.7%	0.030	0.037	7.9%	0.113	0.027	3.6%	0.051	0.023
West	19.2%	0.039	0.006	3.3%	0.043	0.045	8.3%	0.131	0.042	4.5%	0.142	0.142



Table 9-5. Per Capita Intake of Individual Fruits and Vegetables (g/kg-day as consumed) (continued)

Population Group	Percent Consuming	Peas		Peppers			Pumpkins			Snap Beans		
		Mean	SE	Percent Consuming	Mean	SE	Percent Consuming	Mean	SE	Percent Consuming	Mean	SE
<b>Total</b>	12.8%	0.095	0.009	6.5%	0.022	0.005	1.0%	0.026	0.032	21.5%	0.146	0.008
<b>Age (years)</b>												
< 01	13.7%	0.294	0.142	0.7%	0.003	0.025	5.2%	0.497	0.363	16.7%	0.439	0.154
01-02	13.6%	0.174	0.083	2.4%	0.011	0.031	0.4%	0.030	0.253	24.9%	0.383	0.070
03-05	12.9%	0.199	0.077	3.0%	0.014	0.032	0.7%	0.018	0.148	25.0%	0.274	0.048
06-11	13.2%	0.120	0.029	4.7%	0.019	0.016	0.4%	0.012	0.118	25.6%	0.183	0.024
12-19	8.4%	0.053	0.021	5.3%	0.017	0.014	0.2%	0	0.007	18.3%	0.112	0.018
20-39	10.9%	0.067	0.013	7.9%	0.026	0.009	0.6%	0.007	0.026	19.0%	0.096	0.010
40-69	14.8%	0.084	0.011	8.6%	0.027	0.008	1.2%	0.011	0.018	22.3%	0.124	0.011
70 +	16.4%	0.117	0.024	4.7%	0.010	0.008	1.7%	0.034	0.053	25.5%	0.149	0.019
<b>Season</b>												
Fall	13.2%	0.120	0.023	6.0%	0.023	0.009	1.9%	0.043	0.056	21.5%	0.164	0.018
Spring	12.6%	0.077	0.015	7.3%	0.021	0.009	0.6%	0.034	0.105	18.9%	0.109	0.013
Summer	11.2%	0.074	0.019	7.9%	0.023	0.009	0.4%	0.012	0.064	22.3%	0.147	0.016
Winter	14.1%	0.111	0.017	4.7%	0.019	0.010	1.0%	0.015	0.037	23.7%	0.163	0.017
<b>Urbanization</b>												
Central City	11.7%	0.085	0.018	6.5%	0.023	0.009	1.1%	0.035	0.068	20.2%	0.133	0.015
Nonmetropolitan	14.5%	0.113	0.020	6.0%	0.017	0.006	0.5%	0.015	0.068	22.3%	0.141	0.013
Suburban	12.5%	0.094	0.014	6.8%	0.023	0.007	1.3%	0.025	0.041	22.0%	0.156	0.013
<b>Race</b>												
Asian	8.1%	0.047	0.071	8.1%	0.102	0.112	0.7%	0.005	0.057	13.4%	0.059	0.050
Black	17.0%	0.143	0.032	3.6%	0.005	0.007	0.3%	0.037	0.238	24.1%	0.188	0.022
Native American	2.9%	0.007	0.035	5.3%	0.015	0.031	0.0%	0	0	21.1%	0.119	0.048
Other/NA	6.9%	0.037	0.058	11.1%	0.037	0.024	0.9%	0.024	0.208	15.1%	0.168	0.073
White	12.5%	0.092	0.010	6.8%	0.022	0.005	1.2%	0.025	0.030	21.5%	0.140	0.009
<b>Region</b>												
Midwest	10.9%	0.071	0.014	4.7%	0.016	0.011	1.2%	0.027	0.050	22.4%	0.146	0.014
Northeast	12.5%	0.101	0.026	9.0%	0.036	0.012	1.4%	0.061	0.106	19.7%	0.131	0.020
South	16.2%	0.126	0.017	5.8%	0.015	0.006	0.5%	0.002	0.026	24.3%	0.177	0.014
West	9.5%	0.067	0.018	7.6%	0.025	0.010	1.3%	0.030	0.060	17.5%	0.107	0.019



Table 9-5. Per Capita Intake of Individual Fruits and Vegetables (g/kg-day as consumed) (continued)

Population Group	Strawberries			Tomatoes			White Potatoes		
	Percent Consuming	Mean	SE	Percent Consuming	Mean	SE	Percent Consuming	Mean	SE
<b>Total</b>	3.4%	0.039	0.019	91.8%	0.876	0.010	87.6%	1.093	0.013
<b>Age (years)</b>									
< 01	0.7%	0.018	0.154	64.2%	1.116	0.094	59.9%	1.102	0.128
01-02	1.6%	0.155	0.598	93.8%	1.838	0.103	84.2%	2.228	0.113
03-05	3.2%	0.045	0.080	94.9%	1.700	0.072	88.1%	1.817	0.086
06-11	3.3%	0.052	0.058	95.2%	1.160	0.032	90.5%	1.702	0.058
12-19	2.3%	0.016	0.028	95.5%	0.852	0.022	90.1%	1.238	0.042
20-39	2.7%	0.028	0.020	94.7%	0.791	0.013	88.6%	0.897	0.018
40-69	4.5%	0.042	0.020	90.6%	0.673	0.013	88.1%	0.882	0.018
70 +	5.8%	0.050	0.040	87.2%	0.689	0.027	88.9%	0.865	0.031
<b>Season</b>									
Fall	1.3%	0.008	0.017	92.5%	0.907	0.021	88.9%	1.169	0.027
Spring	7.7%	0.105	0.045	90.6%	0.808	0.018	86.3%	1.036	0.024
Summer	2.2%	0.030	0.032	92.4%	0.946	0.019	86.5%	1.001	0.029
Winter	2.5%	0.013	0.015	91.9%	0.844	0.018	88.7%	1.167	0.024
<b>Urbanization</b>									
Central City	2.8%	0.028	0.020	91.5%	0.827	0.017	84.7%	1.017	0.025
Nonmetropolitan	3.8%	0.052	0.029	90.7%	0.827	0.018	89.4%	1.211	0.027
Suburban	3.6%	0.040	0.035	92.8%	0.931	0.015	88.5%	1.087	0.019
<b>Race</b>									
Asian	3.4%	0.395	1.152	90.6%	1.147	0.110	77.2%	0.446	0.062
Black	1.5%	0.031	0.056	87.4%	0.713	0.027	83.3%	1.202	0.047
Native American	1.8%	0.023	0.120	84.2%	0.890	0.073	85.4%	1.735	0.134
Other/NA	1.4%	0.007	0.042	91.4%	1.004	0.049	77.1%	1.036	0.080
White	3.9%	0.037	0.013	92.8%	0.892	0.011	88.9%	1.082	0.014
<b>Region</b>									
Midwest	4.8%	0.051	0.025	92.2%	0.814	0.019	89.2%	1.246	0.029
Northeast	3.3%	0.059	0.079	93.0%	0.988	0.024	86.6%	1.090	0.030
South	2.6%	0.025	0.019	90.7%	0.831	0.016	88.5%	1.074	0.021
West	3.3%	0.028	0.025	92.3%	0.914	0.021	85.1%	0.946	0.026
NOTE: SE = Standard error P = Percentile of the distribution									
Source: Based on EPA's analyses of the 1989-91 CSFII									



Table 9-6. Per Capita Intake of USDA Categories of Fruits and Vegetables (g/kg-day as consumed)

Population Group	Dark Green Vegetables			Deep Yellow Vegetables			Citrus Fruits			Other Fruits			Other Vegetables		
	Percent Consuming	Mean	SE	Percent Consuming	Mean	SE	Percent Consuming	Mean	SE	Percent Consuming	Mean	SE	Percent Consuming	Mean	SE
<b>Total</b>	19.1%	0.180	0.012	20.0%	0.147	0.010	38.0%	1.236	0.039	57.7%	2.141	0.063	83.1%	1.316	0.016
<b>Age (years)</b>															
< 01	7.5%	0.180	0.177	10.1%	0.178	0.157	24.8%	1.929	0.586	61.6%	12.855	1.284	41.7%	1.346	0.200
01-02	12.4%	0.364	0.137	14.4%	0.281	0.109	43.6%	4.237	0.459	66.4%	7.599	0.498	73.6%	2.077	0.136
03-05	14.8%	0.390	0.119	16.3%	0.177	0.063	41.0%	2.596	0.267	70.0%	5.826	0.348	78.9%	1.979	0.102
06-11	13.3%	0.150	0.044	19.1%	0.185	0.043	40.5%	1.805	0.138	70.1%	3.242	0.126	83.2%	1.534	0.062
12-19	14.3%	0.112	0.030	14.0%	0.080	0.020	37.0%	1.130	0.085	47.3%	1.053	0.070	81.0%	0.950	0.035
20-39	18.8%	0.137	0.016	17.5%	0.100	0.015	33.4%	0.903	0.049	44.9%	0.972	0.042	84.1%	1.081	0.022
40-69	24.4%	0.187	0.016	24.8%	0.164	0.017	39.9%	0.864	0.045	60.9%	1.255	0.038	88.3%	1.374	0.026
70 +	24.6%	0.255	0.034	29.4%	0.245	0.028	46.8%	1.155	0.069	76.1%	1.827	0.067	87.7%	1.615	0.046
<b>Season</b>															
Fall	19.6%	0.169	0.023	22.7%	0.156	0.020	38.3%	1.211	0.074	57.6%	2.354	0.171	82.5%	1.276	0.032
Spring	21.0%	0.187	0.020	19.7%	0.144	0.023	38.4%	1.225	0.072	56.4%	2.024	0.102	83.3%	1.297	0.030
Summer	15.4%	0.182	0.029	15.6%	0.094	0.017	33.8%	1.136	0.093	60.8%	2.245	0.112	83.1%	1.332	0.032
Winter	20.0%	0.180	0.024	21.9%	0.192	0.023	41.3%	1.371	0.073	56.0%	1.943	0.106	83.4%	1.361	0.031
<b>Urbanization</b>															
Central City	20.5%	0.197	0.021	18.6%	0.133	0.019	39.8%	1.187	0.072	55.3%	2.090	0.100	81.4%	1.245	0.027
Nonmetropolitan	16.0%	0.133	0.020	18.4%	0.138	0.021	34.2%	1.153	0.074	57.8%	1.954	0.100	83.2%	1.407	0.033
Suburban	19.9%	0.190	0.019	22.0%	0.160	0.016	39.1%	1.306	0.058	59.2%	2.262	0.110	84.1%	1.319	0.023
<b>Race</b>															
Asian	30.9%	0.327	0.127	29.5%	0.221	0.118	51.0%	2.479	0.453	69.8%	3.360	0.547	85.2%	2.228	0.205
Black	25.9%	0.318	0.039	12.5%	0.104	0.029	40.1%	1.474	0.135	46.2%	1.806	0.156	78.1%	1.232	0.044
Native American	9.4%	0.126	0.092	10.5%	0.081	0.060	33.3%	0.945	0.219	50.9%	2.375	0.431	75.4%	1.077	0.107
Other/NA	15.1%	0.224	0.087	13.4%	0.106	0.071	40.3%	1.439	0.229	52.0%	2.589	0.452	76.3%	1.116	0.104
White	18.1%	0.156	0.012	21.6%	0.154	0.011	37.4%	1.178	0.041	59.8%	2.154	0.071	84.2%	1.326	0.017
<b>Region</b>															
Midwest	12.6%	0.125	0.026	18.7%	0.128	0.020	35.5%	1.099	0.077	59.8%	2.137	0.108	81.2%	1.186	0.029
Northeast	21.1%	0.185	0.026	22.1%	0.175	0.026	45.6%	1.430	0.079	60.5%	2.235	0.132	84.5%	1.445	0.040
South	20.5%	0.206	0.021	16.8%	0.119	0.018	33.5%	1.090	0.067	50.3%	1.927	0.095	83.2%	1.346	0.026
West	22.6%	0.195	0.022	25.2%	0.187	0.021	41.8%	1.449	0.092	65.0%	2.414	0.182	83.8%	1.293	0.033
NOTE: SE = Standard error P = Percentile of the distribution															
Source: Based on EPA's analyses of the 1989-91 CSFII															



Table 9-7. Per Capita Intake of Exposed Fruits (g/kg-day as consumed)

Population Group	Percent Consuming	Mean	SE	P1	P5	P10	P25	P50	P75	P90	P95	P99	P100
<b>Total</b>	44.1%	1.435	0.062	0	0	0	0	0	1.402	3.496	6.075	17.823	204.28
<b>Age (years)</b>													
< 01	54.7%	9.224	1.247	0	0	0	0	2.897	12.336	26.98	33.216	75.353	204.28
01-02	55.3%	5.682	0.486	0	0	0	0	2.897	8.598	15.187	19.107	33.353	80.189
03-05	56.9%	4.324	0.344	0	0	0	0	2.305	5.766	11.65	19.049	24.123	48.728
06-11	58.8%	2.316	0.12	0	0	0	0	1.379	3.32	5.879	8.585	15.318	25.367
12-19	36.4%	0.682	0.065	0	0	0	0	0	0.871	2.158	3.214	6.703	10.766
20-39	32.7%	0.596	0.038	0	0	0	0	0	0.754	1.984	2.858	5.911	28.486
40-69	44.3%	0.716	0.031	0	0	0	0	0	1.102	2.139	3.048	5.127	13.206
70 +	57.7%	1.032	0.058	0	0	0	0	0.534	1.452	2.894	4.042	6.983	10.631
<b>Season</b>													
Fall	45.5%	1.753	0.179	0	0	0	0	0	1.521	3.64	7.537	25.206	204.28
Spring	42.6%	1.184	0.078	0	0	0	0	0	1.283	3.208	5.505	14.872	84.336
Summer	45.3%	1.44	0.113	0	0	0	0	0	1.389	3.451	6.313	17.427	98.133
Winter	43.0%	1.362	0.097	0	0	0	0	0	1.441	3.54	5.703	18.752	59.848
<b>Urbanization</b>													
Central City	42.4%	1.322	0.088	0	0	0	0	0	1.328	3.481	6.075	15.927	80.189
Nonmetropolitan	44.0%	1.335	0.097	0	0	0	0	0	1.445	3.32	5.505	16.057	84.336
Suburban	45.3%	1.553	0.112	0	0	0	0	0	1.442	3.686	6.614	20.444	204.28
<b>Race</b>													
Asian	52.3%	2.118	0.541	0	0	0	0	0.654	1.674	4.299	8.678	25.206	27.337
Black	34.6%	1.132	0.149	0	0	0	0	0	1.045	2.888	4.618	17.351	80.189
Native American	35.7%	0.939	0.316	0	0	0	0	0	0.922	2.271	4.157	15.635	17.684
Other/NA	34.0%	1.614	0.408	0	0	0	0	0	1.659	4.084	8.529	35.073	36.71
White	46.1%	1.468	0.07	0	0	0	0	0	1.441	3.593	6.104	17.427	204.28
<b>Region</b>													
Midwest	47.3%	1.422	0.091	0	0	0	0	0	1.645	3.501	6.114	16.438	84.336
Northeast	47.3%	1.518	0.118	0	0	0	0	0	1.49	3.898	6.834	19.393	75.353
South	36.9%	1.271	0.092	0	0	0	0	0	1.177	3.104	5.695	19.91	80.189
West	49.4%	1.643	0.198	0	0	0	0	0	1.443	3.774	7.009	15.947	204.28
NOTE: SE = Standard error P = Percentile of the distribution Source: Based on EPA's analyses of the 1989-91 CSFII													





Table 9-8. Per Capita Intake of Protected Fruits (g/kg-day as consumed)

Population Group	Percent Consuming	Mean	SE	P1	P5	P10	P25	P50	P75	P90	P95	P99	P100
<b>Total</b>	52.9%	1.692	0.037	0	0	0	0	0.598	2.316	4.687	6.717	13.019	136.69
<b>Age (years)</b>													
< 01	38.9%	3.097	0.528	0	0	0	0	0	4.353	9.963	15.242	23.624	136.69
01-02	56.7%	5.518	0.455	0	0	0	0	2.618	9.049	15.677	20.912	27.432	49.904
03-05	57.0%	3.443	0.235	0	0	0	0	1.948	5.606	9.826	13.018	17.729	35.141
06-11	56.2%	2.339	0.125	0	0	0	0	1.079	3.727	6.92	8.688	12.807	27.945
12-19	47.7%	1.401	0.081	0	0	0	0	0.598	2.234	4.341	5.761	7.894	15.503
20-39	45.4%	1.188	0.047	0	0	0	0	0.108	1.694	3.645	4.844	8.205	29.275
40-69	57.3%	1.284	0.043	0	0	0	0	0.583	2.009	3.541	4.596	7.719	21.372
70 +	67.5%	1.78	0.072	0	0	0	0	1.236	2.706	4.363	5.779	8.611	15.003
<b>Season</b>													
Fall	50.2%	1.539	0.071	0	0	0	0	0.269	2.04	4.323	6.509	13.595	26.751
Spring	53.9%	1.75	0.072	0	0	0	0	0.688	2.407	4.681	6.787	13.032	44.68
Summer	54.1%	1.754	0.082	0	0	0	0	0.672	2.471	4.732	6.571	15.503	136.69
Winter	53.7%	1.727	0.071	0	0	0	0	0.621	2.423	4.941	6.905	12.166	30.692
<b>Urbanization</b>													
Central City	53.3%	1.632	0.069	0	0	0	0	0.625	2.276	4.497	6.099	11.535	136.69
Nonmetropolitan	49.4%	1.55	0.069	0	0	0	0	0.334	2.115	4.368	6.961	12.076	29.275
Suburban	54.7%	1.797	0.056	0	0	0	0	0.667	2.472	4.897	6.826	14.399	44.68
<b>Race</b>													
Asian	69.8%	3.279	0.429	0	0	0	0	2.052	4.382	6.981	17.729	17.729	18.792
Black	49.6%	1.861	0.126	0	0	0	0	0.621	2.695	5.64	7.241	13.572	136.69
Native American	46.8%	2.019	0.33	0	0	0	0	0.851	2.701	5.995	10.354	11.554	15.244
Other/NA	51.7%	2.014	0.263	0	0	0	0	0.845	2.472	5.759	8.88	14.279	44.68
White	53.4%	1.629	0.039	0	0	0	0	0.574	2.238	4.527	6.425	12.53	49.904
<b>Region</b>													
Midwest	49.5%	1.501	0.072	0	0	0	0	0.265	2.07	4.353	6.099	12.53	49.904
Northeast	59.4%	1.887	0.08	0	0	0	0	0.838	2.675	5.371	7.268	13.018	42.347
South	47.6%	1.56	0.064	0	0	0	0	0.465	2.147	4.443	6.39	12.076	136.69
West	60.1%	1.947	0.084	0	0	0	0	0.854	2.613	4.88	7.836	16.064	44.68
NOTE: SE = Standard error P = Percentile of the distribution													
Source: Based on EPA's analyses of the 1989-91 CSFII													



Table 9-9. Per Capita Intake of Exposed Vegetables (g/kg-day as consumed)

Population Group	Percent Consuming	Mean	SE	P1	P5	P10	P25	P50	P75	P90	P95	P99	P100
<b>Total</b>	84.9%	1.49	0.016	0	0	0	0.367	1.043	2.067	3.403	4.515	7.727	20.492
<b>Age (years)</b>													
< 01	42.7%	1.208	0.17	0	0	0	0	0	1.55	3.834	6.451	11.524	18.592
01-02	78.0%	2.268	0.145	0	0	0	0.299	1.132	3.616	5.855	7.404	12.808	20.492
03-05	83.6%	2.245	0.119	0	0	0	0.329	1.411	3.061	5.433	7.664	12.493	17.872
06-11	84.7%	1.606	0.059	0	0	0	0.293	1.062	2.222	3.769	5.118	9.161	15.741
12-19	83.6%	1.181	0.04	0	0	0	0.253	0.804	1.696	2.756	3.84	5.699	12.139
20-39	86.3%	1.3	0.025	0	0	0	0.331	0.923	1.87	2.968	3.692	6.327	14.837
40-69	89.9%	1.568	0.026	0	0	0.07	0.557	1.22	2.177	3.42	4.443	6.274	13.624
70 +	86.4%	1.603	0.044	0	0	0	0.672	1.326	2.214	3.344	4.206	5.928	12.814
<b>Season</b>													
Fall	82.8%	1.383	0.033	0	0	0	0.29	0.951	1.824	3.151	4.283	8.783	18.592
Spring	85.0%	1.475	0.031	0	0	0	0.383	1.028	2.075	3.406	4.562	7.403	20.492
Summer	87.1%	1.634	0.033	0	0	0	0.432	1.272	2.289	3.68	4.765	7.399	18.283
Winter	84.9%	1.468	0.033	0	0	0	0.367	0.999	2.09	3.109	4.464	7.664	16.152
<b>Urbanization</b>													
Central City	83.6%	1.413	0.029	0	0	0	0.302	0.957	1.952	3.278	4.331	8.17	20.492
Nonmetropolitan	85.8%	1.55	0.031	0	0	0	0.471	1.185	2.146	3.499	4.59	7.283	17.872
Suburban	85.2%	1.511	0.025	0	0	0	0.356	1.055	2.098	3.464	4.683	7.664	16.152
<b>Race</b>													
Asian	83.2%	2.133	0.195	0	0	0	0.606	1.537	3.135	4.746	6.883	10.325	11.841
Black	81.8%	1.472	0.051	0	0	0	0.308	0.908	1.88	3.217	4.989	9.219	16.141
Native American	75.4%	1.501	0.141	0	0	0	0.168	1.018	2.423	3.445	4.155	6.424	8.189
Other/NA	85.4%	1.682	0.092	0	0	0	0.338	1.287	2.748	3.644	4.697	6.933	8.368
White	85.6%	1.476	0.017	0	0	0	0.371	1.045	2.067	3.376	4.464	7.359	20.492
<b>Region</b>													
Midwest	80.9%	1.215	0.029	0	0	0	0.239	0.824	1.683	2.843	3.834	6.35	20.492
Northeast	84.7%	1.561	0.041	0	0	0	0.378	1.051	2.126	3.564	4.994	8.243	18.283
South	86.7%	1.609	0.027	0	0	0	0.434	1.208	2.254	3.575	4.562	7.404	14.568
West	86.6%	1.546	0.035	0	0	0	0.424	1.127	2.158	3.524	4.7	7.664	16.152
NOTE: SE = Standard error P = Percentile of the distribution													
Source: Based on EPA's analyses of the 1989-91 CSFII													



Table 9-10. Per Capita Intake of Protected Vegetables (g/kg-day as consumed)

Population Group	Percent Consuming	Mean	SE	P1	P5	P10	P25	P50	P75	P90	P95	P99	P100
<b>Total</b>	34.0%	0.332	0.012	0	0	0	0	0	0.414	1.038	1.637	3.394	14.4
<b>Age (years)</b>													
< 01	30.9%	1.144	0.192	0	0	0	0	0	1.435	4.584	6.25	8.752	14.4
01-02	41.6%	0.794	0.104	0	0	0	0	0	1.201	2.232	3.766	6.488	9.74
03-05	39.8%	0.703	0.081	0	0	0	0	0	1.205	2.443	3.053	4.811	11.3
06-11	44.3%	0.5	0.035	0	0	0	0	0	0.848	1.439	2.058	3.32	8.6
12-19	30.1%	0.229	0.025	0	0	0	0	0	0.332	0.824	1.339	2.138	4.94
20-39	31.6%	0.233	0.015	0	0	0	0	0	0.323	0.78	1.161	2.427	5.6
40-69	32.4%	0.239	0.014	0	0	0	0	0	0.362	0.772	1.164	2.033	6.25
70 +	34.6%	0.303	0.028	0	0	0	0	0	0.427	1.015	1.491	2.291	5.34
<b>Season</b>													
Fall	34.1%	0.336	0.025	0	0	0	0	0	0.394	1.064	1.725	3.674	11.3
Spring	34.8%	0.32	0.024	0	0	0	0	0	0.421	0.96	1.435	3.493	14.4
Summer	32.5%	0.334	0.024	0	0	0	0	0	0.411	1.116	1.7	3.492	10.4
Winter	34.4%	0.337	0.022	0	0	0	0	0	0.42	1.109	1.724	2.945	8.68
<b>Urbanization</b>													
Central City	31.7%	0.303	0.022	0	0	0	0	0	0.354	0.971	1.619	3.098	14.4
Nonmetropolitan	37.9%	0.396	0.024	0	0	0	0	0	0.514	1.22	1.725	3.826	11.3
Suburban	33.1%	0.32	0.018	0	0	0	0	0	0.39	1.029	1.591	3.32	14.1
<b>Race</b>													
Asian	16.1%	0.166	0.081	0	0	0	0	0	0	0.636	1.201	1.506	3.17
Black	37.3%	0.411	0.038	0	0	0	0	0	0.502	1.29	2.014	4.579	9.07
Native American	32.7%	0.38	0.095	0	0	0	0	0	0.446	1.062	1.826	2.85	4.64
Other/NA	22.9%	0.221	0.074	0	0	0	0	0	0	0.644	1.369	2.767	5.6
White	34.1%	0.326	0.013	0	0	0	0	0	0.413	1.014	1.587	3.317	14.4
<b>Region</b>													
Midwest	35.8%	0.344	0.022	0	0	0	0	0	0.46	1.127	1.674	3.013	11.3
Northeast	32.4%	0.369	0.036	0	0	0	0	0	0.376	1.102	1.835	5.022	14.1
South	36.8%	0.358	0.019	0	0	0	0	0	0.48	1.093	1.726	3.484	14.4
West	28.4%	0.236	0.022	0	0	0	0	0	0.178	0.791	1.257	2.688	6.25
NOTE: SE = Standard error P = Percentile of the distribution													
Source: Based on EPA's analyses of the 1989-91 CSFII													



Table 9-11. Per Capita Intake of Root Vegetables (g/kg-day as consumed)

Population Group	Percent Consuming	Mean	SE	P1	P5	P10	P25	P50	P75	P90	P95	P99	P100
<b>Total</b>	80.7%	1.245	0.015	0	0	0	0.226	0.832	1.675	2.974	4.029	7.074	30.609
<b>Age (years)</b>													
< 01	52.4%	1.857	0.204	0	0	0	0	0.184	2.66	5.337	8.233	12.5	30.609
01-02	76.2%	2.398	0.129	0	0	0	0.52	1.879	3.542	5.695	7.084	10.449	16.27
03-05	77.9%	1.914	0.096	0	0	0	0.203	1.344	2.998	4.596	6.14	7.505	17.416
06-11	84.4%	1.85	0.065	0	0	0	0.381	1.23	2.638	4.449	6.018	8.165	17.107
12-19	81.4%	1.29	0.045	0	0	0	0.279	0.909	1.739	3.051	4.177	5.74	24.949
20-39	81.6%	0.988	0.02	0	0	0	0.182	0.717	1.37	2.385	3.096	5.025	8.002
40-69	82.8%	1.059	0.021	0	0	0	0.244	0.807	1.488	2.454	3.087	4.983	9.043
70 +	80.6%	1.109	0.04	0	0	0	0.312	0.821	1.549	2.535	3.203	5.636	10.723
<b>Season</b>													
Fall	80.6%	1.324	0.032	0	0	0	0.213	0.893	1.756	3.238	4.402	7.484	15.625
Spring	80.5%	1.204	0.029	0	0	0	0.228	0.858	1.557	2.752	3.889	6.644	30.609
Summer	80.3%	1.102	0.031	0	0	0	0.152	0.655	1.452	2.669	3.858	7.751	24.949
Winter	81.5%	1.348	0.029	0	0	0	0.339	0.97	1.953	3.1	4.137	5.989	17.416
<b>Urbanization</b>													
Central City	77.6%	1.167	0.029	0	0	0	0.176	0.755	1.545	2.826	3.903	7.505	30.609
Nonmetropolitan	82.3%	1.33	0.03	0	0	0	0.311	0.893	1.795	3.256	4.422	6.946	19.449
Suburban	81.9%	1.254	0.023	0	0	0	0.21	0.861	1.708	2.972	4.017	7.079	17.416
<b>Race</b>													
Asian	55.0%	0.743	0.146	0	0	0	0	0.274	0.814	1.764	3.546	7.269	10.702
Black	73.8%	1.309	0.052	0	0	0	0.134	0.761	1.627	3.337	5.358	7.968	17.534
Native American	78.9%	1.791	0.137	0	0	0	0.655	1.47	2.762	3.858	4.705	7.067	13.578
Other/NA	65.4%	1.239	0.11	0	0	0	0	0.635	1.75	3.38	4.861	8.253	10.415
White	82.9%	1.237	0.016	0	0	0	0.25	0.858	1.673	2.887	3.942	6.651	30.609
<b>Region</b>													
Midwest	82.2%	1.361	0.033	0	0	0	0.29	0.889	1.844	3.238	4.386	7.968	19.449
Northeast	80.2%	1.304	0.037	0	0	0	0.21	0.912	1.781	3.212	4.246	7.022	24.949
South	81.2%	1.183	0.024	0	0	0	0.25	0.796	1.591	2.82	3.906	6.926	30.609
West	78.5%	1.15	0.032	0	0	0	0.146	0.786	1.56	2.673	3.683	7.269	13.578
NOTE: SE = Standard error P = Percentile of the distribution													
Source: Based on EPA's analyses of the 1989-91 CSFII													



Table 9-12. Mean Daily Intake of Fruits and Vegetables Per Individual in a Day for USDA 1977-78, 87-88, 89-91, 94, and 95 Surveys

Food Product	77-78 Data (g/day)	87-88 Data (g/day)	89-91 Data (g/day)	94 Data (g/day)	95 Data (g/day)
Fruits	142	142	156	171	173
Vegetables	201	182	179	186	188

Source: USDA, 1980; 1992; 1996a; 1996b.



Table 9-13. Mean Per Capita Intake Rates (as consumed) for Fruits and Vegetables Based on All Sex/Age/Demographic Subgroups

Raw Agricultural Commodity <sup>a</sup>	Average Consumption (Grams/kg Body Weight-Day)	Standard Error
Alfalfa Sprouts	0.0001393	0.0000319
Apples-Dried	0.0002064	0.0000566
Apples-Fresh	0.4567290	0.0142203
Apples-Juice	0.2216490	0.0142069
Apricots-Dried	0.0004040	0.0001457
Apricots-Fresh	0.0336893	0.0022029
Artichokes-Globe	0.0032120	0.0007696
Artichokes-Jerusalem	0.0000010	*
Asparagus	0.0131098	0.0010290
Avocados	0.0125370	0.0020182
Bamboo Shoots	0.0001464	0.0000505
Bananas-Dried	0.0004489	0.0001232
Bananas-Fresh	0.2240382	0.0088206
Bananas-Unspecified	0.0032970	0.0004938
Beans-Dry-Blackeye Peas (cowpeas)	0.0024735	0.0005469
Beans-Dry-Broad Beans (Mature Seed)	0.0000000	*
Beans-Dry-Garbanzo (Chick Pea)	0.0005258	0.0001590
Beans-Dry-Great Northern	0.0000010	*
Beans-Dry-Hyacinth (Mature Seeds)	0.0000000	*
Beans-Dry-Kidney	0.0136313	0.0045628
Beans-Dry-Lima	0.0079892	0.0016493
Beans-Dry-Navy (Pea)	0.0374073	0.0023595
Beans-Dry-Other	0.0398251	0.0023773
Beans-Dry-Pigeon Beans	0.0000357	0.0000357
Beans-Dry-Pinto	0.0363498	0.0048479
Beans-Succulent-Broad Beans (Immature Seed)	0.0000000	*
Beans-Succulent-Green	0.2000500	0.0062554
Beans-Succulent-Hyacinth (Young Pods)	0.0000000	*
Beans-Succulent-Lima	0.0256648	0.0021327
Beans-Succulent-Other	0.0263838	0.0042782
Beans-Succulent-Yellow, Wax	0.0054634	0.0009518
Beans-Unspecified	0.0052345	0.0012082



Table 9-13. Mean Per Capita Intake Rates (as consumed) for Fruits and Vegetables Based on All Sex/Age/Demographic Subgroups (continued)

Raw Agricultural Commodity <sup>a</sup>	Average Consumption (Grams/kg Body Weight-Day)	Standard Error
Beets-Roots	0.0216142	0.0014187
Beets-Tops (Greens)	0.0008287	0.0003755
Bitter Melon	0.0000232	0.0000233
Blackberries	0.0064268	0.0007316
Blueberries	0.0090474	0.0008951
Boysenberries	0.0007313	0.0006284
Bread Nuts	0.0000010	*
Bread Fruit	0.0000737	0.0000590
Broccoli	0.0491295	0.0032966
Brussel Sprouts	0.0068480	0.0009061
Cabbage-Chinese/Celery, Inc. Bok Choy	0.0045632	0.0020966
Cabbage-Green and Red	0.0936402	0.0039046
Cactus Pads	0.0000010	*
Cantaloupes	0.0444220	0.0029515
Carambola	0.0000010	*
Carob	0.0000913	0.0000474
Carrots	0.1734794	0.0041640
Casabas	0.0007703	0.0003057
Cassava (Yuca Blanca)	0.0002095	0.00001574
Cauliflower	0.0158368	0.0011522
Celery	0.0609611	0.0014495
Cherimoya	0.0000010	*
Cherries-Dried	0.0000010	*
Cherries-Fresh	0.0321754	0.0024966
Cherries-Juice	0.0034080	0.0009078
Chicory (French or Belgian Endive)	0.0006707	0.0001465
Chili Peppers	0.0000000	*
Chives	0.0000193	0.0000070
Citrus Citron	0.0001573	0.0000324
Coconut-Copra	0.0012860	0.0000927
Coconut-Fresh	0.0001927	0.0000684
Coconut-Water	0.0000005	0.0000005



Table 9-13. Mean Per Capita Intake Rates (as consumed) for Fruits and Vegetables Based on All Sex/Age/Demographic Subgroups (continued)

Raw Agricultural Commodity <sup>a</sup>	Average Consumption (Grams/kg Body Weight-Day)	Standard Error
Collards	0.0188966	0.0032628
Corn, Pop	0.0067714	0.0003348
Corn, Sweet	0.2367071	0.0062226
Crabapples	0.0003740	*
Cranberries	0.0150137	0.0006153
Cranberries-Juice	0.0170794	0.0022223
Crenshaws	0.0000010	*
Cress, Upland	0.0000010	*
Cress, Garden, Field	0.0000000	*
Cucumbers	0.0720821	0.0034389
Currants	0.0005462	0.0000892
Dandelion	0.0005039	0.0002225
Dates	0.0006662	0.0001498
Dewberries	0.0023430	*
Eggplant	0.0061858	0.0007645
Elderberries	0.0001364	0.0001365
Endive, Curley and Escarole	0.0011851	0.0001929
Fennel	0.0000000	*
Figs	0.0027847	0.0005254
Garlic	0.0007621	0.0000230
Genip (Spanish Lime)	0.0000010	*
Ginkgo Nuts	0.0000010	*
Gooseberries	0.0003953	0.0001341
Grapefruit-Juice	0.0773585	0.0053846
Grapefruit-Pulp	0.0684644	0.0032321
Grapes-Fresh	0.0437931	0.0023071
Grapes-Juice	0.0900960	0.0058627
Grapes-Leaves	0.0000119	0.0000887
Grapes-Raisins	0.0169730	0.0009221
Groundcherries (Poha or Cape- Gooseberries)	0.0000000	*
Guava	0.0000945	0.0000558
Honeydew Melons	0.0183628	0.0042879





Table 9-13. Mean Per Capita Intake Rates (as consumed) for Fruits and Vegetables Based on All Sex/Age/Demographic Subgroups (continued)

Raw Agricultural Commodity <sup>a</sup>	Average Consumption (Grams/kg Body Weight-Day)	Standard Error
Huckleberries (Gaylussacia)	0.0000010	*
Juneberry	0.0000010	*
Kale	0.0015036	0.0006070
Kiwi	0.0000191	0.0000191
Kohlrabi	0.0002357	0.0001028
Kumquats	0.0000798	0.0000574
Lambsquarter	0.0000481	0.0000481
Leafy Oriental Vegetables	0.0000010	*
Leeks	0.0000388	0.0000221
Lemons-Juice	0.0189564	0.0009004
Lemons-Peel	0.0002570	0.0001082
Lemons-Pulp	0.0002149	0.0000378
Lemons-Unspecified	0.0020695	0.0003048
Lentiles-Split	0.0000079	0.0000064
Lentiles-Whole	0.0012022	0.0002351
Lettuce-Head Varieties	0.2122803	0.0059226
Lettuce-Leafy Varieties	0.0044328	0.0003840
Lettuce-Unspecified	0.0092008	0.0004328
Limes-Juice	0.0032895	0.0005473
Limes-Pulp	0.0000941	0.0000344
Limes-Unspecified	0.0000010	*
Loganberries	0.0002040	*
Logan Fruit	0.0000010	*
Loquats	0.0000000	*
Lychee-Dried	0.0000010	*
Lychees (Litchi)	0.0000010	*
Maney (Mammee Apple)	0.0000010	*
Mangoes	0.0005539	0.0002121
Mulberries	0.0000010	*
Mung Beans (Sprouts)	0.0066521	0.0006462
Mushrooms	0.0213881	0.0009651
Mustard Greens	0.0145284	0.0024053



Table 9-13. Mean Per Capita Intake Rates (as consumed) for Fruits and Vegetables Based on All Sex/Age/Demographic Subgroups (continued)

Raw Agricultural Commodity <sup>a</sup>	Average Consumption (Grams/kg Body Weight-Day)	Standard Error
Nectarines	0.0129663	0.0013460
Okra	0.0146352	0.0017782
Olives	0.0031757	0.0002457
Onions-Dehydrated or Dried	0.0001192	0.0000456
Onions-Dry-Bulb (Cipollini)	0.1060612	0.0021564
Onions-Green	0.0019556	0.0001848
Oranges-Juice	1.0947265	0.0283937
Oranges-Peel	0.0001358	0.0000085
Oranges-Pulp	0.1503524	0.0092049
Papayas-Dried	0.0009598	0.0000520
Papayas-Fresh	0.0013389	0.0005055
Papayas-Juice	0.0030536	0.0012795
Parsley Roots	0.0000010	*
Parsley	0.0036679	0.0001459
Parsnips	0.0006974	0.0001746
Passion Fruit (Granadilla)	0.0000010	*
Pawpaws	0.0000010	*
Peaches-Dried	0.0000496	0.0000152
Peaches-Fresh	0.2153916	0.0078691
Pears-Dried	0.0000475	0.0000279
Pears-Fresh	0.1224735	0.0050442
Peas (Garden)-Green Immature	0.1719997	0.0067868
Peas (Garden)-Mature Seeds, Dry	0.0017502	0.0002004
Peppers, Sweet, Garden	0.0215525	0.0010091
Peppers-Other	0.0043594	0.0004748
Persimmons	0.0004008	0.0002236
Persian Melons	0.0000010	*
Pimentos	0.0019485	0.0001482
Pineapple-Dried	0.0000248	0.0000195
Pineapple-Fresh, Pulp	0.0308283	0.0017136
Pineapple-Fresh, Juice	0.0371824	0.0026438
Pitanga (Surinam Cherry)	0.0000010	*



Table 9-13. Mean Per Capita Intake Rates (as consumed) for Fruits and Vegetables Based on All Sex/Age/Demographic Subgroups (continued)

Raw Agricultural Commodity <sup>a</sup>	Average Consumption (Grams/kg Body Weight-Day)	Standard Error
Plantains	0.0016370	0.0007074
Plums, Prune-Juice	0.0137548	0.0017904
Plums (Damsons)-Fresh	0.0248626	0.0020953
Plums-Prunes (Dried)	0.0058071	0.0005890
Poke Greens	0.0002957	0.0001475
Pomegranates	0.0000820	0.0000478
Potatoes (White)-Whole	0.3400582	0.0102200
Potatoes (White)-Unspecified	0.0000822	0.0000093
Potatoes (White)-Peeled	0.7842573	0.0184579
Potatoes (White)-Dry	0.0012994	0.0001896
Potatoes (White)-Peel Only	0.0000217	0.0000133
Pumpkin	0.0044182	0.0004354
Quinces	0.0001870	*
Radishes-Roots	0.0015558	0.0001505
Radishes-Tops	0.0000000	*
Raspberries	0.0028661	0.0005845
Rhubarb	0.0037685	0.0006588
Rutabagas-Roots	0.0027949	0.0009720
Rutabagas-Tops	0.0000000	*
Salsify (Oyster Plant)	0.0000028	0.0000028
Shallots	0.0000000	*
Soursop (Annona Muricata)	0.0000010	*
Soybeans-Sprouted Seeds	0.0000000	*
Spinach	0.0435310	0.0030656
Squash-Summer	0.0316479	0.0022956
Squash-Winter	0.0324417	0.0026580
Strawberries	0.0347089	0.0020514
Sugar Apples (Sweetsop)	0.0000010	*
Sweetpotatoes (including Yams)	0.0388326	0.0035926
Swiss Chard	0.0016915	0.0004642
Tangelos	0.0025555	0.0006668
Tangerine-Juice	0.0000839	0.0000567



Table 9-13. Mean Per Capita Intake Rates (as consumed) for Fruits and Vegetables Based on All Sex/Age/Demographic Subgroups (continued)

Raw Agricultural Commodity <sup>a</sup>	Average Consumption (Grams/kg Body Weight-Day)	Standard Error
Tangerines	0.0088441	0.0010948
Tapioca	0.0012199	0.0000951
Taro-Greens	0.0000010	*
Taro-Root	0.0000010	*
Tomatoes-Catsup	0.0420320	0.0015878
Tomatoes-Juice	0.0551351	0.0029515
Tomatoes-Paste	0.0394767	0.0012512
Tomatoes-Puree	0.17012311	0.0054679
Tomatoes-Whole	0.4920164	0.0080927
Towelgourd	0.0000010	*
Turnips-Roots	0.0082392	0.0014045
Turnips-Tops	0.0147111	0.0025845
Water Chestnuts	0.0004060	0.0000682
Watercress	0.0003553	0.0001564
Watermelon	0.0765054	0.0068930
Yambean, Tuber	0.0000422	0.0000402
Yautia, Tannier	0.0000856	0.0000571
Youngberries	0.0003570	*

\* Not reported  
<sup>a</sup> Consumed in any raw or prepared form  
 Source: DRES data base (based on 1977-78 NFCS data).



Chapter 9 - Intake of Fruits and Vegetables

Table 9-14. Mean Total Fruit Intake (as consumed) in a Day by Sex and Age (1977-1978)<sup>a</sup>

Age (yr)	Per Capita Intake (g/day)	Percent of Population Using Fruit in a Day	Intake (g/day) for Users Only <sup>b</sup>
<b>Males and Females</b>			
1 and under	169	86.8	196
1-2	146	62.9	231
3-5	134	56.1	239
6-8	152	60.1	253
<b>Males</b>			
9-11	133	50.5	263
12-14	120	51.2	236
15-18	147	47.0	313
19-22	107	39.4	271
23-34	141	46.4	305
35-50	115	44.0	262
51-64	171	62.4	275
65-74	174	62.2	281
75 and over	186	62.6	197
<b>Females</b>			
9-11	148	59.7	247
12-14	120	48.7	247
15-18	126	49.9	251
19-22	133	48.0	278
23-34	122	47.7	255
35-50	133	52.8	252
51-64	171	66.7	256
65-74	179	69.3	259
75 and over	189	64.7	292
<b>Males and Females</b>			
All ages	142	54.2	263

<sup>a</sup> Based on USDA Nationwide Food Consumption Survey (1977-1978) data for one day.  
<sup>b</sup> Intake for users only was calculated by dividing the per capita intake rate by the fraction of the population using fruit in a day.  
 Source: USDA, 1980.

Table 9-15. Mean Total Fruit Intake (as consumed) in a Day by Sex and Age (1987-1988)<sup>a</sup>

Age (yr)	Per Capita Intake (g/day)	Percent of Population Using Fruit in 1 Day	Intake (g/day) for Users Only <sup>b</sup>
<b>Males and Females</b>			
5 and under	157	59.2	265
<b>Males</b>			
6-11	182	63.8	285
12-19	158	49.4	320
20 and over	133	46.5	286
<b>Females</b>			
6-11	154	58.3	264
12-19	131	47.1	278
20 and over	140	52.7	266
<b>Males and Females</b>			
All Ages	142	51.4	276

<sup>a</sup> Based on USDA Nationwide Food Consumption Survey (1987-1988) data for one day.  
<sup>b</sup> Intake for users only was calculated by dividing the per capita intake rate by the fraction of the population using fruits in a day.  
 Source: USDA, 1992b.



Table 9-16. Mean Total Vegetable Intake (as consumed) in a Day by Sex and Age (1977-1978)<sup>a</sup>

Age (yr)	Per Capita Intake (g/day)	Percent of Population Using Vegetables in a Day	Intake (g/day) for Users Only <sup>b</sup>
<u>Males and Females</u>			
1 and under	76	62.7	121
1-2	91	78.0	116
3-5	100	79.3	126
6-8	136	84.3	161
<u>Males</u>			
9-11	138	83.5	165
12-14	184	84.5	217
15-18	216	85.9	251
19-22	226	84.7	267
23-34	248	88.5	280
35-50	261	86.8	300
51-64	285	90.3	316
65-74	265	88.5	300
75 and over	264	93.6	281
<u>Females</u>			
9-11	139	83.7	166
12-14	154	84.6	183
15-18	178	83.8	212
19-22	184	81.1	227
23-34	187	84.7	221
35-50	187	84.6	221
51-64	229	89.8	255
65-74	221	87.2	253
75 & over	198	88.1	226
<u>Males and Females</u>			
All Ages	201	85.6	235

<sup>a</sup> Based on USDA Nationwide Food Consumption Survey (1977-1978) data for one day.

<sup>b</sup> Intake for users only was calculated by dividing the per capita intake rate by the fraction of the population using vegetables in a day.

Source: USDA, 1980.

Table 9-17. Mean Total Vegetable Intake (as consumed) in a Day by Sex and Age (1987-1988)<sup>a</sup>

Age (yr)	Per Capita Intake (g/day)	Percent of Population Using Vegetables in a Day	Intake (g/day) for Users Only <sup>b</sup>
<u>Males and Females</u>			
5 and under	81	74.0	109
<u>Males</u>			
6-11	129	86.8	149
12-19	173	85.2	203
20 and over	232	85.0	273
<u>Females</u>			
6-11	129	80.6	160
12-19	129	75.8	170
20 and over	183	82.9	221
<u>Males and Females</u>			
All Ages	182	82.6	220

<sup>a</sup> Based on USDA Nationwide Food Consumption Survey (1987-1988) data for one day.

<sup>b</sup> Intake for users only was calculated by dividing the per capita intake rate by the fraction of the population using vegetables in a day.

Source: USDA, 1992b.



Chapter 9 - Intake of Fruits and Vegetables

Table 9-18. Mean Total Fruit Intake (as consumed) in a Day by Sex and Age (1994 and 1995)<sup>a</sup>

Age (yr)	Per Capita Intake (g/day)		Percent of Population Using Fruit in 1 Day		Intake (g/day) for Users Only <sup>b</sup>	
	1994	1995	1994	1995	1994	1995
<b>Males and Females</b>						
5 and under	230	221	70.6	72.6	326	304
<b>Males</b>						
6-11	176	219	59.8	62.2	294	352
12-19	169	210	44.0	47.1	384	446
20 and over	175	170	50.2	49.6	349	342
<b>Females</b>						
6-11	174	172	59.3	63.6	293	270
12-19	148	167	47.1	44.4	314	376
20 and over	157	155	55.1	54.4	285	285
<b>Males and Females</b>						
All Ages	171	173	54.1	54.2	316	319

<sup>a</sup> Based on USDA CSFII (1994 and 1995) data for one day.  
<sup>b</sup> Intake for users only was calculated by dividing the per capita intake rate by the fraction of the population using fruits in a day.  
 Source: USDA, 1996a; 1996b.

Table 9-19. Mean Total Vegetable Intake (as consumed) in a Day by Sex and Age (1994 and 1995)<sup>a</sup>

Age (yr)	Per Capita Intake (g/day)		Percent of Population Using Vegetables in 1 Day		Intake (g/day) for Users Only <sup>b</sup>	
	1994	1995	1994	1995	1994	1995
<b>Males and Females</b>						
5 and under	80	83	75.2	75.0	106	111
<b>Males</b>						
6-11	118	111	82.4	80.6	143	138
12-19	154	202	74.9	79.0	206	256
20 and over	242	241	85.9	86.4	282	278
<b>Females</b>						
6-11	115	108	82.9	79.1	139	137
12-19	132	144	78.5	76.0	168	189
20 and over	190	189	84.7	83.2	224	227
<b>Males and Females</b>						
All Ages	186	188	83.2	82.6	223	228

<sup>a</sup> Based on USDA CSFII (1994 and 1995) data for one day.  
<sup>b</sup> Intake for users only was calculated by dividing the per capita intake rate by the fraction of the population using vegetables in a day.  
 Source: USDA, 1996a; 1996b.



Table 9-20. Mean Per Capita Intake of Fats and Oils (g/day as consumed) in a Day by Sex and Age (1994 and 1995)<sup>a</sup>

	Total Fats and Oils <sup>b</sup>		Table Fats <sup>c</sup>		Salad Dressings <sup>d</sup>	
	1994	1995	1994	1995	1994	1995
<u>Males and Females</u>						
5 and under	4	3	2	2	2	1
<u>Males</u>						
6-11	8	7	3	3	5	4
12-19	11	14	2	5	8	10
20 and over	19	18	5	5	11	10
<u>Females</u>						
6-11	7	8	3	3	4	4
12-19	9	9	2	3	6	6
20 and over	16	14	4	5	10	7
<u>Males and Females</u>						
All Ages	14	14	4	4	9	8

<sup>a</sup> Based on USDA CSFII 1994 and 1995 data for one day.  
<sup>b</sup> Table fats, cooking fats, vegetable oils, salad dressings, nondairy cream substitutes, sauces that are mainly fat and oil.  
<sup>c</sup> Butter, margarines, blends of butter with margarines or vegetable oils, and butter replacements.  
<sup>d</sup> Regular and reduced- and low-calorie dressings and mayonnaise.

Source: USDA, 1996a; 1996b.

Table 9-21. Mean and Standard Error for the Per Capita Daily Intake of Food Class and Subclass by Region (g/day as consumed)

	US population	Northeast	North Central	South	West
Total Produce	282.6 ± 3.5	270.6 ± 6.9	282.4 ± 6.7	280.7 ± 5.6	303.1 ± 8.2
Leafy <sup>a</sup>	39.2 ± 0.8	38.1 ± 1.5	37.1 ± 1.5	38.4 ± 1.2	45.3 ± 1.8
Exposed <sup>b</sup>	86.0 ± 1.5	88.5 ± 3.0	87.8 ± 2.9	76.9 ± 2.4	95.5 ± 3.6
Protected <sup>c</sup>	150.4 ± 2.3	137.2 ± 4.5	150.1 ± 4.3	160.1 ± 3.6	152.5 ± 5.3
Other	7.0 ± 0.3	6.9 ± 0.6	7.3 ± 0.5	5.4 ± 0.4	9.8 ± 0.7

<sup>a</sup> Produce belonging to this category include: cabbage, cauliflower, broccoli, celery, lettuce, and spinach.  
<sup>b</sup> Produce belonging to this category include: apples, pears, berries, cucumber, squash, grapes, peaches, apricots, plums, prunes, string beans, pea pods, and tomatoes.  
<sup>c</sup> Produce belonging to this category include: carrots, beets, turnips, parsnips, citrus fruits, sweet corn, legumes (peas, beans, etc.), melons, onion, and potatoes.

NOTE: Northeast = Maine, New Hampshire, Vermont, Massachusetts, Connecticut, Rhode Island, New York, New Jersey, and Pennsylvania.  
North Central = Ohio, Illinois, Indiana, Wisconsin, Michigan, Minnesota, Iowa, Missouri, North Dakota, South Dakota, Nebraska, and Kansas.  
South = Maryland, Delaware, District of Columbia, Virginia, West Virginia, North Carolina, South Carolina, Georgia, Florida, Kentucky, Tennessee, Alabama, Mississippi, Arkansas, Louisiana, Texas, and Oklahoma.  
West = Montana, Idaho, Wyoming, Utah, Colorado, New Mexico, Arizona, Nevada, Washington, Oregon, and California.

Source: U.S. EPA, 1984b (based on 1977-78 NFCS data).





Table 9-22. Mean and Standard Error for the Daily Intake of Food Subclasses Per Capita by Age (g/day as consumed)

Age (years)	Leafy produce <sup>a</sup>	Exposed produce <sup>b</sup>	Protected produce <sup>c</sup>	Other produce
All Ages	39.2 ± 0.8	86.0 ± 1.5	150.4 ± 2.3	7.0 ± 0.3
<1	3.2 ± 4.9	75.5 ± 9.8	50.8 ± 14.7	25.5 ± 1.8
1-4	9.1 ± 2.4	55.6 ± 4.8	94.5 ± 7.2	5.1 ± 0.9
5-9	20.1 ± 2.0	69.2 ± 4.8	128.9 ± 6.1	4.3 ± 0.8
10-14	26.1 ± 1.9	76.8 ± 3.8	151.7 ± 5.7	8.1 ± 0.7
15-19	31.4 ± 2.0	71.9 ± 4.0	156.6 ± 6.0	6.2 ± 0.7
20-24	35.3 ± 2.6	65.6 ± 5.2	144.5 ± 7.8	5.0 ± 1.0
25-29	41.4 ± 2.7	73.4 ± 5.3	149.8 ± 8.0	7.0 ± 1.0
30-39	44.4 ± 2.1	77.1 ± 4.2	150.5 ± 6.3	6.1 ± 0.8
40-59	51.3 ± 1.6	94.7 ± 3.3	162.9 ± 4.9	6.9 ± 0.6
≥ 60	45.4 ± 1.8	114.2 ± 3.6	163.9 ± 5.5	7.6 ± 0.7

<sup>a</sup> Produce belonging to this category include: cabbage, cauliflower, broccoli, celery, lettuce, and spinach.  
<sup>b</sup> Produce belonging to this category include: apples, pears, berries, cucumber, squash, grapes, peaches, apricots, plums, prunes, string beans, pea pods, and tomatoes.  
<sup>c</sup> Produce belonging to this category include: carrots, beets, turnips, parsnips, citrus fruits, sweet corn, legumes (peas, beans, etc.), melons, onion, and potatoes.  
 Source: U.S. EPA, 1984a (based on 1977-78 NFCS data).

Table 9-23. Consumption of Foods (g dry weight/day) for Different Age Groups and Estimated Lifetime Average Daily Food Intakes for a US Citizen (averaged across sex) Calculated from the FDA Diet Data

	Age (in years)						Estimated Lifetime Intake <sup>a</sup>
	(0-1)	(1-5)	(6-13)	(14-19)	(20-44)	(45-70)	
Potatoes	5.67	10.03	14.72	19.40	17.28	14.79	15.60
Leafy Veg.	0.84	0.49	0.85	1.22	2.16	2.65	1.97
Legume Veg.	3.81	4.56	6.51	8.45	9.81	9.50	8.75
Root Veg.	3.04	0.67	1.20	1.73	1.77	1.64	1.60
Garden fruits	0.66	1.67	2.57	3.47	4.75	4.86	4.15
Peanuts	0.34	2.21	2.56	2.91	2.43	1.91	2.25
Mushrooms	0.00	0.01	0.03	0.04	0.14	0.06	0.08
Veg. Oils	27.62	17.69	27.54	37.04	37.20	27.84	31.24

<sup>a</sup> The estimated lifetime dietary intakes were estimated by:  

$$\text{Estimated lifetime} = \frac{\text{IR}(0-1) + 5\text{yrs} * \text{IR}(1-5) + 8\text{yrs} * \text{IR}(6-13) + 6\text{yrs} * \text{IR}(14-19) + 25\text{yrs} * \text{IR}(20-44) + 25\text{yrs} * \text{IR}(45-70)}{70\text{ years}}$$
 where IR = the intake rate for a specific age group.  
 Source: U.S. EPA, 1989 (based on 1977-78 NFCS and NHANES II data).



Table 9-24. Mean Daily Intake of Foods (grams) Based on the Nutrition Canada Dietary Survey<sup>a</sup>

Age (yrs)	Sample Size	Fruit and Fruit Products	Vegetables Not Including Potatoes	Potatoes	Nuts and Legumes
<b>Males and Females</b>					
1-4	1031	258	56	75	6
5-11	1995	312	83	110	13
<b>Males</b>					
12-19	1070	237	94	185	20
20-39	999	244	155	189	15
40-64	1222	194	134	131	15
65+	881	165	118	124	8
<b>Females</b>					
12-19	1162	237	97	115	15
20-39	1347	204	134	99	8
40-64	1500	239	136	79	10
65+	818	208	103	80	5
<b>Pregnant Females</b>					
---	769	301	156	114	15

<sup>a</sup> Report does not specify whether means were calculated per capita or for consumers only. The reported values are consistent with the as consumed intake rates for consumers only reported by USDA (1980).  
Source: Canadian Department of National Health and Welfare, n.d.

Table 9-25. Per Capita Consumption of Fresh Fruits and Vegetables in 1991<sup>a</sup>

Fresh Fruits		Fresh Vegetables	
Food Item	Per Capita Consumption (g/day) <sup>b</sup>	Food Item	Per Capita Consumption (g/day) <sup>b</sup>
<b>Citrus</b>		Artichokes	0.62
Oranges (includes Temple oranges)	10.2	Asparagus	0.75
Tangerines and Tangelos	1.6	Snap Beans	1.4
Lemons	3.1	Broccoli	3.5
Limes	0.9	Brussel Sprouts	0.4
Grapefruit	7.1	Cabbage	9.5
Total Fresh Citrus	22.9	Carrots	9.0
<b>Noncitrus</b>		Cauliflower	2.2
Apples	21.8	Celery	7.8
Apricots	0.1	Sweet Corn	6.6
Avocados	1.7	Cucumber	5.2
Bananas	31.2	Eggplant	0.5
Cherries	0.5	Escarole/Endive	0.3
Cranberries	0.4	Garlic	1.6
Grapes	8.2	Head Lettuce	30.2
Kiwi Fruit	0.5	Onions	18.4
Mangoes	1.0	Bell Peppers	5.8
Peaches & Nectarines	7.6	Radishes	0.6
Pears	3.7	Spinach	0.9
Pineapple	2.2	Tomatoes	16.3
Papayas	0.3	Total Fresh Vegetables	126.1
Plums and Prunes	1.7		
Strawberries	4.1		
Total Fresh Noncitrus	85.0		
Total Fresh Fruits	107.7		

<sup>a</sup> Based on retail-weight equivalent. Includes imports; excludes exports and foods grown in home gardens. Data for 1991 used.  
<sup>b</sup> Original data were presented in lbs/yr; data were converted to g/day by multiplying by a factor of 454 g/lb and dividing by 365 days/yr.  
Source: USDA, 1993.



Table 9-26. Quantity (as consumed) of Fruits and Vegetables Consumed Per Eating Occasion and the Percentage of Individuals Using These Foods in Three Days

Food category	% Indiv. using food in 3 days	Quantity consumed per eating occasion (g)		Consumers-only						
				Quantity consumed per eating occasion at specified percentiles (g)						
				5	25	50	75	90	95	99
		Average	Standard Deviation							
<u>Raw vegetables</u>										
White potatoes	74.4	125	90	29	63	105	170	235	280	426
Cabbage and coleslaw	9.7	68	45	15	40	60	90	120	120	240
Carrots	5	43	40	4	13	31	55	100	122	183
Cucumbers	5.6	80	76	8	24	70	110	158	220	316
Lettuce and tossed salad	50.7	65	59	10	20	55	93	140	186	270
Mature onions	8.5	31	33	3	17	18	36	57	72	180
Tomatoes	27.8	81	55	30	45	62	113	123	182	246
<u>Cooked vegetables</u>										
Broccoli	6.2	112	68	30	78	90	155	185	190	350
Cabbage	4.7	128	83	28	75	145	150	225	300	450
Carrots	9.8	70	59	19	46	75	92	150	155	276
Corn, whole kernel	23.9	95	56	21	65	83	123	170	170	330
Lima beans	2.8	110	75	21	67	88	170	175	219	350
Mixed vegetables	3.4	117	69	28	91	94	182	187	187	374
Cowpeas, field peas, black-eyed peas	2.9	131	88	22	88	88	175	196	350	350
Green peas	18.3	90	57	20	43	85	85	170	170	330
Spinach	4.5	121	70	24	78	103	185	205	205	380
String beans	27.3	86	54	18	67	70	135	140	140	280
Summer squash	2.8	145	98	27	105	108	215	215	352	430
Sweet potatoes	4.1	136	87	38	86	114	185	225	238	450
Tomato juice	3.9	91	122	91	122	182	243	243	363	486
Cucumber pickles	9.2	45	45	7	16	30	65	90	130	222
<u>Fruits</u>										
Grapefruit	4.7	159	58	106	134	134	165	268	268	330
Grapefruit juice	3.6	202	99	95	125	186	247	250	375	500
Oranges	9	146	57	73	145	145	145	180	228	360
Orange juice	35.5	190	84	95	125	187	249	249	311	498
Apples	18.2	141	49	69	138	138	138	212	212	276
Applesauce, cooked apples	9.8	134	86	28	64	128	130	255	155	488
Apple juice	3.8	191	101	63	124	186	248	248	372	496
Cantaloupe	3.3	171	91	61	136	136	272	272	272	529
Raw peaches	4.5	160	75	76	152	152	152	304	304	456
Raw pears	3.1	163	69	82	164	164	164	164	328	328
Raw strawberries	2.1	100	58	37	75	75	149	149	180	298

<sup>a</sup> Percentiles are cumulative; for example, 50 percent of people eat 105 g white potatoes per day or less.  
Source: Pao et al., 1982 (based on 1977-78 NFCS data).



Table 9-27. Mean Moisture Content of Selected Fruits and Vegetables Expressed as Percentages of Edible Portions

Food	Moisture Content (Percent)		Comments
	Raw	Cooked	
<u>Fruit</u>			
Apples - dried	31.76	84.13*	sulfured; *without added sugar
Apples 83.93*	84.46**	*with skin; **without skin	
Apples - juice		87.93	canned or bottled
Applesauce		88.35*	*unsweetened
Apricots	86.35	86.62*	*canned juice pack with skin
Apricots - dried	31.09	85.56*	sulfured; *without added sugar
Bananas	74.26		
Blackberries	85.64		
Blueberries	84.61	86.59*	*frozen unsweetened
Boysenberries	85.90		frozen unsweetened
Cantaloupes - unspecified	89.78		
Casabas	91.00		
Cherries - sweet	80.76	84.95*	*canned, juice pack
Crabapples	78.94		
Cranberries	86.54		
Cranberries - juice cocktail	85.00		bottled
Currants (red and white)	83.95		
Elderberries	79.80		
Grapefruit	90.89		
Grapefruit - juice	90.00	90.10*	*canned unsweetened
Grapefruit - unspecified	90.89		pink, red, white
Grapes - fresh	81.30		American type (slip skin)
Grapes - juice	84.12		canned or bottled
Grapes - raisins	15.42		seedless
Honeydew melons	89.66		
Kiwi fruit	83.05		
Kumquats	81.70		
Lemons - juice	90.73	92.46*	*canned or bottled
Lemons - peel	81.60		
Lemons - pulp	88.98		
Limes - juice	90.21	92.52*	*canned or bottled
Limes - unspecified	88.26		
Loganberries	84.61		
Mulberries	87.68		
Nectarines	86.28		
Oranges - unspecified	86.75		all varieties
Peaches	87.66	87.49*	*canned juice pack
Pears - dried	26.69	64.44*	sulfured; *without added sugar
Pears - fresh	83.81	86.47*	*canned juice pack
Pineapple	86.50	83.51*	*canned juice pack
Pineapple - juice		85.53	canned
Plums		85.20	
Quinces	83.80		
Raspberries	86.57		
Strawberries	91.57	89.97*	*frozen unsweetened
Tangerine - juice	88.90	87.00*	*canned sweetened
Tangerines	87.60	89.51*	*canned juice pack
Watermelon	91.51		
<u>Vegetables</u>			
Alfalfa sprouts	91.14		
Artichokes - globe & French	84.38	86.50	boiled, drained
Artichokes - Jerusalem	78.01		



Chapter 9 - Intake of Fruits and Vegetables

Table 9-27. Mean Moisture Content of Selected Fruits and Vegetables Expressed as Percentages of Edible Portions (continued)

Food	Moisture Content (Percent)		Comments
	Raw	Cooked	
Asparagus	92.25	92.04	boiled, drained
Bamboo shoots	91.00	95.92	boiled, drained
Beans - dry			
Beans - dry - blackeye peas (cowpeas)	66.80	71.80	boiled, drained
Beans - dry - hyacinth (mature seeds)	87.87	86.90	boiled, drained
Beans - dry - navy (pea)	79.15	76.02	boiled, drained
Beans - dry - pinto	81.30	93.39	boiled, drained
Beans - lima	70.24	67.17	boiled, drained
Beans - snap - Italian - green - yellow	90.27	89.22	boiled, drained
Beets	87.32	90.90	boiled, drained
Beets - tops (greens)	92.15	89.13	boiled, drained
Broccoli	90.69	90.20	boiled, drained
Brussel sprouts	86.00	87.32	boiled, drained
Cabbage - Chinese/celery, including bok choy	95.32	95.55	boiled, drained
Cabbage - red	91.55	93.60	boiled, drained
Cabbage - savoy	91.00	92.00	boiled, drained
Carrots	87.79	87.38	boiled, drained
Cassava (yucca blanca)	68.51		
Cauliflower	92.26	92.50	boiled, drained
Celeriac	88.00	92.30	boiled, drained
Celery	94.70	95.00	boiled, drained
Chili peppers	87.74	92.50*	*canned solids & liquid
Chives	92.00		
Cole slaw	81.50		
Collards	93.90	95.72	boiled, drained
Corn - sweet	75.96	69.57	boiled, drained
Cress - garden - field	89.40	92.50	boiled, drained
Cress - garden	89.40	92.50	boiled, drained
Cucumbers	96.05		
Dandelion - greens	85.60	89.80	boiled, drained
Eggplant	91.93	91.77	boiled, drained
Endive	93.79		
Garlic	58.58		
Kale	84.46	91.20	boiled, drained
Kohlrabi	91.00	90.30	boiled, drained
Lambsquarter	84.30	88.90	boiled, drained
Leeks	83.00	90.80	boiled, drained
Lentils - whole	67.34	68.70	stir-fried
Lettuce - iceberg	95.89		
Lettuce - romaine	94.91		
Mung beans (sprouts)	90.40	93.39	boiled, drained
Mushrooms	91.81	91.08	boiled, drained
Mustard greens	90.80	94.46	boiled, drained
Okra	89.58	89.91	boiled, drained
Onions	90.82	92.24	boiled, drained
Onions - dehydrated or dried	3.93		
Parsley	88.31		
Parsley roots	88.31		
Parsnips	79.53	77.72	boiled, drained
Peas (garden) - mature seeds - dry	88.89	88.91	boiled, drained
Peppers - sweet - garden	92.77	94.70	boiled, drained
Potatoes (white) - peeled	78.96	75.42	baked



Table 9-27. Mean Moisture Content of Selected Fruits and Vegetables Expressed as Percentages of Edible Portions (continued)

Food	Moisture Content (Percent)		Comments
	Raw	Cooked	
Potatoes (white) - whole	83.29	71.20	baked
Pumpkin	91.60	93.69	boiled, drained
Radishes - roots	94.84		
Rhubarb	93.61	67.79	frozen, cooked with added sugar
Rutabagas - unspecified	89.66	90.10	boiled, drained
Salsify (oyster plant)	77.00	81.00	boiled, drained
Shallots	79.80		
Soybeans - sprouted seeds	69.05	79.45	steamed
Spinach	91.58	91.21	boiled, drained
Squash - summer	93.68	93.70	all varieties; boiled, drained
Squash - winter	88.71	89.01	all varieties; baked
Sweetpotatoes (including yams)	72.84	71.85	baked in skin
Swiss chard	92.66	92.65	boiled, drained
Tapioca - pearl	10.99		dry
Taro - greens	85.66	92.15	steamed
Taro - root	70.64	63.80	
Tomatoes - juice		93.90	canned
Tomatoes - paste		74.06	canned
Tomatoes - puree		87.26	canned
Tomatoes - raw	93.95		
Tomatoes - whole	93.95	92.40	boiled, drained
Towelgourd	93.85	84.29	boiled, drained
Turnips - roots	91.87	93.60	boiled, drained
Turnips - tops	91.07	93.20	boiled, drained
Water chestnuts	73.46		
Yambean - tuber	89.15	87.93	boiled, drained

Source: USDA, 1979-1986.



Table 9-28. Summary of Fruit and Vegetable Intake Studies

Study	Survey Population Used in Calculating Intake	Types of Data Used	Units	Food Items
<b><u>KEY STUDIES</u></b>				
EPA Analysis of 1989-91 USDA CSFII data	Per capita data; consumer only data can be calculated	1989-91 CSFII data; Based on 3-day average individual intake rate	g/kg-day; as consumed	Major food groups; individual food items; exposed and protected fruits and vegetables; USDA food categories
<b><u>RELEVANT STUDIES</u></b>				
AIHC, 1994	Per Capita	Based on the 1977-78 USDA NFCS data provided in the 1989 version of the Exposure Factors Handbook.	g/day	Distributions for vegetables using @Risk software.
Canadian Department of National Health and Welfare, n.d.	Not known if per capita or consumers only	1970-72 survey based on 24-hour dietary recall	g/day; not known if as consumed	Fruit and fruit products, vegetables not including potatoes and nuts and legumes
EPA's DRES	Per capita (i.e., consumers and nonconsumers)	1977-78 NFCS 3-day individual intake data	g/kg-day; as consumed	Intake for a wide variety of fruits and vegetables presented; complex food groups were disaggregated
Pao et al., 1982	Consumers only serving size data provided	1977-78 NFCS 3-day individual intake data	g; as consumed	Serving sizes for only a limited number of products
USDA, 1980; 1992b; 1996a; 1996b	Per capita and consumer only	1977-78 and 1987-88 NFCS, and 1994 and 1995 CSFII 1-day individual intake data	g/day; as consumed	Total fruits and total vegetables
USDA, 1993	Per capita consumption based on "food disappearance"	Based on food supply and utilization data provided by the National Agricultural Statistics Service (NASS), Customs Service Reports, and trade associations	g/day; as consumed	Various food groups
U.S. EPA/ORP, 1984a; 1984b	Per capita	1977-78 NFCS Individual intake data	g/day; as consumed	Exposed, protected, and leafy produce
U.S. EPA/OST, 1989	Estimated lifetime dietary intake	Based on FDA Total Diet Study Food List which used 1977-78 NFCS data, and NHANES II data	g/day; dry weight	Various food groups; complex foods disaggregated



Table 9-29. Summary of Recommended Values for Per Capita Intake of Fruits and Vegetables			
Mean	95th Percentile	Multiple Percentiles	Study
<u>Total Fruit Intake</u>			
3.4 g/kg-day	12 g/kg-day	see Table 9-3	EPA Analysis of CSFII 1989-91 Data
<u>Total Vegetable Intake</u>			
4.3 g/kg-day	10 g/kg-day	see Table 9-4	EPA Analysis of CSFII 1989-91 Data
<u>Individual Fruit and Vegetables Intake</u>			
see Table 9-5	---	---	EPA Analysis of CSFII 1989-91 Data





Table 9-30. Confidence in Fruit and Vegetable Intake Recommendations

Considerations	Rationale	Rating
<b>Study Elements</b>		
<ul style="list-style-type: none"> <li>Level of peer review</li> </ul>	USDA CSFII survey receives high level of peer review. EPA analysis of these data has been peer reviewed outside the Agency.	High
<ul style="list-style-type: none"> <li>Accessibility</li> </ul>	CSFII data are publicly available.	High
<ul style="list-style-type: none"> <li>Reproducibility</li> </ul>	Enough information is included to reproduce results.	High
<ul style="list-style-type: none"> <li>Focus on factor of interest</li> </ul>	Analysis is specifically designed to address food intake.	High
<ul style="list-style-type: none"> <li>Data pertinent to U.S.</li> </ul>	Data focuses on the U.S. population.	High
<ul style="list-style-type: none"> <li>Primary data</li> </ul>	This is new analysis of primary data.	High
<ul style="list-style-type: none"> <li>Currency</li> </ul>	Were the most current data publicly available at the time the analysis was conducted for the Handbook.	High
<ul style="list-style-type: none"> <li>Adequacy of data collection period</li> </ul>	Survey is designed to collect short-term data.	Medium confidence for average values; Low confidence for long term percentile distribution
<ul style="list-style-type: none"> <li>Validity of approach</li> </ul>	Survey methodology was adequate.	High
<ul style="list-style-type: none"> <li>Study size</li> </ul>	Study size was very large and therefore adequate.	High
<ul style="list-style-type: none"> <li>Representativeness of the population</li> </ul>	The population studied was the U.S. population.	High
<ul style="list-style-type: none"> <li>Characterization of variability</li> </ul>	Survey was not designed to capture long term day-to-day variability. Short term distributions are provided.	Medium
<ul style="list-style-type: none"> <li>Lack of bias in study design (high rating is desirable)</li> </ul>	Response rate was adequate.	Medium
<ul style="list-style-type: none"> <li>Measurement error</li> </ul>	No measurements were taken. The study relied on survey data.	N/A
<b>Other Elements</b>		
<ul style="list-style-type: none"> <li>Number of studies</li> </ul>	1; CSFII 1989-91 was the most recent data set publicly available at the time the analysis was conducted for the Handbook. Therefore, it was the only study classified as key study.	Low
<ul style="list-style-type: none"> <li>Agreement between researchers</li> </ul>	Although the CSFII was the only study classified as key study, the results are in good agreement with earlier data.	High
<b>Overall Rating</b>	The survey is representative of U.S. population. Although there was only one study considered key, these data are the most recent and are in agreement with earlier data. The approach used to analyzed the data was adequate. However, due to the limitations of the survey design estimation of long-term percentile values (especially the upper percentiles) is uncertain.	High confidence in the average; Low confidence in the long-term upper percentiles



**APPENDIX 9A**

**CALCULATIONS USED IN THE 1989-91 CSFII ANALYSIS TO CORRECT FOR MIXTURES**



Appendix 9B

APPENDIX 9A  
Calculations Used in the 1989-91 CSFII Analysis to Correct for Mixtures

Distributions of intake for various food groups were generated for the food/items groups using the USDA 1989-91 CSFII data set as described in Sections 9.2.2. and 11.1.2. However, several of the food categories used did not include meats, dairy products, and vegetables that were eaten as mixtures with other foods. Thus, adjusted intake rates were calculated for food items that were identified by USDA (1995) as comprising a significant portion of grain and meat mixtures. To account for the amount of these foods consumed as mixtures, the mean fractions of total meat or grain mixtures represented by these food items were calculated (Table 9A-1) using Appendix C of USDA (1995). Mean values for all individuals were used to calculate these fractions. These fractions were multiplied by each individual's intake rate for total meat mixtures or grain mixtures to calculate the amount of the individual's food mixture intake that can be categorized into one of the selected food groups. These amounts were then added to the total intakes rates for meats, grains, total vegetables, tomatoes, and white potatoes to calculate an individual's total intake of these food groups, as shown in the example for meats below.

$$IR_{meat-adjusted} = (IR_{gr\ mixtures} * Fr_{meat/gr}) + (IR_{mt\ mixtures} * Fr_{meat/mt}) + (IR_{meat})$$

where:

- IR<sub>meat-adjusted</sub> = adjusted individual intake rate for total meat;
- IR<sub>gr mixtures</sub> = individual intake rate for grain mixtures;
- IR<sub>mt mixtures</sub> = individual intake rate for meat mixtures;
- IR<sub>meat</sub> = individual intake rate for meats;
- Fr<sub>meat/gr</sub> = fraction of grain mixture that is meat; and
- Fr<sub>meat/mt</sub> = fraction of meat mixture that is meat.

Population distributions for mixture-adjusted intakes were based on adjusted intake rates for the population of interest.

<u>Grain Mixtures</u>	
total vegetables	0.2360
tomatoes	0.1685
white potatoes	0.0000
total meats	0.0787
beef	0.0449
pork	0.0112
poultry	0.0112
dairy	0.1348
total grains	0.3146
<u>Meat Mixtures</u>	
total vegetables	0.2778
tomatoes	0.1111
white potatoes	0.0333
total meats	0.3556
beef	0.2000
pork	0.0222
poultry	0.0778
dairy	0.0556
total grains	0.1333

APPENDIX 9B



**FOOD CODES AND DEFINITIONS USED IN  
ANALYSIS OF THE 1989-91 USDA CSFII DATA**



Appendix 9B. Food Codes and Definitions Used in Analysis of the 1989-91 USDA CSFII Data

Food Product	Food Codes	
<b>MAJOR FOOD GROUPS</b>		
Total Fruits	6- Fruits citrus fruits and juices dried fruits other fruits fruits/juices & nectar fruit/juices baby food	(includes baby foods)
Total Vegetables	7- Vegetables (all forms) white potatoes & PR starchy dark green vegetables deep yellow vegetables tomatoes and tom. mixtures other vegetables veg. and mixtures/baby food veg. with meat mixtures	411- Beans/legumes 412- Beans/legumes 413- Beans/legumes (includes baby foods; mixtures, mostly vegetables; does not include nuts and seeds)
Total Meats	20- Meat, type not specified 21- Beef 22- Pork 23- Lamb, veal, game, carcass meat 24- Poultry 25- Organ meats, sausages, lunchmeats, meat spreads	(excludes meat, poultry, and fish with non-meat items; frozen plate meals; soups and gravies with meat, poultry and fish base; and gelatin-based drinks; includes baby foods)
Total Dairy	1- Milk and Milk Products milk and milk drinks cream and cream substitutes milk desserts, sauces, and gravies cheeses	(includes regular fluid milk, human milk, imitation milk products, yogurt, milk-based meal replacements, and infant formulas)
<b>INDIVIDUAL FOODS</b>		
White Potatoes	71- White Potatoes and PR Starchy Veg. baked, boiled, chips, sticks, creamed, scalloped, au gratin, fried, mashed, stuffed, puffs, salad, recipes, soups, Puerto Rican starchy vegetables	(does not include vegetable soups; vegetable mixtures; or vegetable with meat mixtures)
Peppers	7512100 Pepper, hot chili, raw 7512200 Pepper, raw 7512210 Pepper, sweet green, raw 7512220 Pepper, sweet red, raw 7522600 Pepper, green, cooked, NS as to fat added 7522601 Pepper, green, cooked, fat not added 7522602 Pepper, green, cooked, fat added 7522604 Pepper, red, cooked, NS as to fat added 7522605 Pepper, red, cooked, fat not added	7522606 Pepper, red, cooked, fat added 7522609 Pepper, hot, cooked, NS as to fat added 7522610 Pepper, hot, cooked, fat not added 7522611 Pepper, hot, cooked, fat added 7551101 Peppers, hot, sauce 7551102 Peppers, pickled 7551105 Peppers, hot pickled (does not include vegetable soups; vegetable mixtures; or vegetable with meat mixtures)
Onions	7510950 Chives, raw 7511150 Garlic, raw 7511250 Leek, raw 7511701 Onions, young green, raw 7511702 Onions, mature 7521550 Chives, dried 7521740 Garlic, cooked 7521840 Leek, cooked 7522100 Onions, mature cooked, NS as to fat added 7522101 Onions, mature cooked, fat not added	7522102 Onions, mature cooked, fat added 7522103 Onions, pearl cooked 7522104 Onions, young green cooked, NS as to fat 7522105 Onions, young green cooked, fat not added 7522106 Onions, young green cooked, fat added 7522110 Onion, dehydrated 7541501 Onions, creamed 7541502 Onion rings (does not include vegetable soups; vegetable mixtures; or vegetable with meat mixtures)



Appendix 9B

Appendix 9B. Food Codes and Definitions Used in Analysis of the 1989-91 USDA CSFII Data (continued)																																																													
Food Product	Food Codes																																																												
Corn	<table border="0"> <tr> <td>7510960</td> <td>Corn, raw</td> <td>7521621</td> <td>Corn, cooked, white/fat not added</td> </tr> <tr> <td>7521600</td> <td>Corn, cooked, NS as to color/fat added</td> <td>7521622</td> <td>Corn, cooked, white/fat added</td> </tr> <tr> <td>7521601</td> <td>Corn, cooked, NS as to color/fat not added</td> <td>7521625</td> <td>Corn, white, cream style</td> </tr> <tr> <td>7521602</td> <td>Corn, cooked, NS as to color/fat added</td> <td>7521630</td> <td>Corn, yellow, canned, low sodium, NS fat</td> </tr> <tr> <td>7521605</td> <td>Corn, cooked, NS as to color/cream style</td> <td>7521631</td> <td>Corn, yell., canned, low sod., fat not add</td> </tr> <tr> <td>7521607</td> <td>Corn, cooked, dried</td> <td>7521632</td> <td>Corn, yell., canned, low sod., fat added</td> </tr> <tr> <td>7521610</td> <td>Corn, cooked, yellow/NS as to fat added</td> <td>7521749</td> <td>Hominy, cooked</td> </tr> <tr> <td>7521611</td> <td>Corn, cooked, yellow/fat not added</td> <td>752175-</td> <td>Hominy, cooked</td> </tr> <tr> <td>7521612</td> <td>Corn, cooked, yellow/fat added</td> <td>7541101</td> <td>Corn scalloped or pudding</td> </tr> <tr> <td>7521615</td> <td>Corn, yellow, cream style</td> <td>7541102</td> <td>Corn fritter</td> </tr> <tr> <td>7521616</td> <td>Corn, cooked, yell. &amp; wh./NS as to fat</td> <td>7541103</td> <td>Corn with cream sauce</td> </tr> <tr> <td>7521617</td> <td>Corn, cooked, yell. &amp; wh./fat not added</td> <td>7550101</td> <td>Corn relish</td> </tr> <tr> <td>7521618</td> <td>Corn, cooked, yell. &amp; wh./fat added</td> <td>76405-</td> <td>Corn, baby</td> </tr> <tr> <td>7521619</td> <td>Corn, yellow, cream style, fat added</td> <td colspan="2">(does not include vegetable soups; vegetable mixtures; or vegetable with meat mixtures; includes baby food)</td> </tr> <tr> <td>7521620</td> <td>Corn, cooked, white/NS as to fat added</td> <td colspan="2"></td> </tr> </table>	7510960	Corn, raw	7521621	Corn, cooked, white/fat not added	7521600	Corn, cooked, NS as to color/fat added	7521622	Corn, cooked, white/fat added	7521601	Corn, cooked, NS as to color/fat not added	7521625	Corn, white, cream style	7521602	Corn, cooked, NS as to color/fat added	7521630	Corn, yellow, canned, low sodium, NS fat	7521605	Corn, cooked, NS as to color/cream style	7521631	Corn, yell., canned, low sod., fat not add	7521607	Corn, cooked, dried	7521632	Corn, yell., canned, low sod., fat added	7521610	Corn, cooked, yellow/NS as to fat added	7521749	Hominy, cooked	7521611	Corn, cooked, yellow/fat not added	752175-	Hominy, cooked	7521612	Corn, cooked, yellow/fat added	7541101	Corn scalloped or pudding	7521615	Corn, yellow, cream style	7541102	Corn fritter	7521616	Corn, cooked, yell. & wh./NS as to fat	7541103	Corn with cream sauce	7521617	Corn, cooked, yell. & wh./fat not added	7550101	Corn relish	7521618	Corn, cooked, yell. & wh./fat added	76405-	Corn, baby	7521619	Corn, yellow, cream style, fat added	(does not include vegetable soups; vegetable mixtures; or vegetable with meat mixtures; includes baby food)		7521620	Corn, cooked, white/NS as to fat added		
7510960	Corn, raw	7521621	Corn, cooked, white/fat not added																																																										
7521600	Corn, cooked, NS as to color/fat added	7521622	Corn, cooked, white/fat added																																																										
7521601	Corn, cooked, NS as to color/fat not added	7521625	Corn, white, cream style																																																										
7521602	Corn, cooked, NS as to color/fat added	7521630	Corn, yellow, canned, low sodium, NS fat																																																										
7521605	Corn, cooked, NS as to color/cream style	7521631	Corn, yell., canned, low sod., fat not add																																																										
7521607	Corn, cooked, dried	7521632	Corn, yell., canned, low sod., fat added																																																										
7521610	Corn, cooked, yellow/NS as to fat added	7521749	Hominy, cooked																																																										
7521611	Corn, cooked, yellow/fat not added	752175-	Hominy, cooked																																																										
7521612	Corn, cooked, yellow/fat added	7541101	Corn scalloped or pudding																																																										
7521615	Corn, yellow, cream style	7541102	Corn fritter																																																										
7521616	Corn, cooked, yell. & wh./NS as to fat	7541103	Corn with cream sauce																																																										
7521617	Corn, cooked, yell. & wh./fat not added	7550101	Corn relish																																																										
7521618	Corn, cooked, yell. & wh./fat added	76405-	Corn, baby																																																										
7521619	Corn, yellow, cream style, fat added	(does not include vegetable soups; vegetable mixtures; or vegetable with meat mixtures; includes baby food)																																																											
7521620	Corn, cooked, white/NS as to fat added																																																												
Apples	<table border="0"> <tr> <td>6210110</td> <td>Apples, dried, uncooked</td> <td>6310141</td> <td>Apple rings, fried</td> </tr> <tr> <td>6210115</td> <td>Apples, dried, uncooked, low sodium</td> <td>6310142</td> <td>Apple, pickled</td> </tr> <tr> <td>6210120</td> <td>Apples, dried, cooked, NS as to sweetener</td> <td>6310150</td> <td>Apple, fried</td> </tr> <tr> <td>6210122</td> <td>Apples, dried, cooked, unsweetened</td> <td>6340101</td> <td>Apple, salad</td> </tr> <tr> <td>6210123</td> <td>Apples, dried, cooked, with sugar</td> <td>6340106</td> <td>Apple, candied</td> </tr> <tr> <td>6210130</td> <td>Apple chips</td> <td>6410101</td> <td>Apple cider</td> </tr> <tr> <td>6310100</td> <td>Apples, raw</td> <td>6410401</td> <td>Apple juice</td> </tr> <tr> <td>6310111</td> <td>Applesauce, NS as to sweetener</td> <td>6410405</td> <td>Apple juice with vitamin C</td> </tr> <tr> <td>6310112</td> <td>Applesauce, unsweetened</td> <td>6410409</td> <td>Apple juice with calcium</td> </tr> <tr> <td>6310113</td> <td>Applesauce with sugar</td> <td>6710200</td> <td>Applesauce baby fd., NS as to str. or jr.</td> </tr> <tr> <td>6310114</td> <td>Applesauce with low calorie sweetener</td> <td>6710201</td> <td>Applesauce baby food, strained</td> </tr> <tr> <td>6310121</td> <td>Apples, cooked or canned with syrup</td> <td>6710202</td> <td>Applesauce baby food, junior</td> </tr> <tr> <td>6310131</td> <td>Apple, baked NS as to sweetener</td> <td>6720200</td> <td>Apple juice, baby food</td> </tr> <tr> <td>6310132</td> <td>Apple, baked, unsweetened</td> <td colspan="2">(includes baby food; except mixtures)</td> </tr> <tr> <td>6310133</td> <td>Apple, baked with sugar</td> <td colspan="2"></td> </tr> </table>	6210110	Apples, dried, uncooked	6310141	Apple rings, fried	6210115	Apples, dried, uncooked, low sodium	6310142	Apple, pickled	6210120	Apples, dried, cooked, NS as to sweetener	6310150	Apple, fried	6210122	Apples, dried, cooked, unsweetened	6340101	Apple, salad	6210123	Apples, dried, cooked, with sugar	6340106	Apple, candied	6210130	Apple chips	6410101	Apple cider	6310100	Apples, raw	6410401	Apple juice	6310111	Applesauce, NS as to sweetener	6410405	Apple juice with vitamin C	6310112	Applesauce, unsweetened	6410409	Apple juice with calcium	6310113	Applesauce with sugar	6710200	Applesauce baby fd., NS as to str. or jr.	6310114	Applesauce with low calorie sweetener	6710201	Applesauce baby food, strained	6310121	Apples, cooked or canned with syrup	6710202	Applesauce baby food, junior	6310131	Apple, baked NS as to sweetener	6720200	Apple juice, baby food	6310132	Apple, baked, unsweetened	(includes baby food; except mixtures)		6310133	Apple, baked with sugar		
6210110	Apples, dried, uncooked	6310141	Apple rings, fried																																																										
6210115	Apples, dried, uncooked, low sodium	6310142	Apple, pickled																																																										
6210120	Apples, dried, cooked, NS as to sweetener	6310150	Apple, fried																																																										
6210122	Apples, dried, cooked, unsweetened	6340101	Apple, salad																																																										
6210123	Apples, dried, cooked, with sugar	6340106	Apple, candied																																																										
6210130	Apple chips	6410101	Apple cider																																																										
6310100	Apples, raw	6410401	Apple juice																																																										
6310111	Applesauce, NS as to sweetener	6410405	Apple juice with vitamin C																																																										
6310112	Applesauce, unsweetened	6410409	Apple juice with calcium																																																										
6310113	Applesauce with sugar	6710200	Applesauce baby fd., NS as to str. or jr.																																																										
6310114	Applesauce with low calorie sweetener	6710201	Applesauce baby food, strained																																																										
6310121	Apples, cooked or canned with syrup	6710202	Applesauce baby food, junior																																																										
6310131	Apple, baked NS as to sweetener	6720200	Apple juice, baby food																																																										
6310132	Apple, baked, unsweetened	(includes baby food; except mixtures)																																																											
6310133	Apple, baked with sugar																																																												
Tomatoes	74- Tomatoes and Tomato Mixtures raw, cooked, juices, sauces, mixtures, soups, sandwiches																																																												
Snap Beans	<table border="0"> <tr> <td>7510180</td> <td>Beans, string, green, raw</td> <td>7520602</td> <td>Beans, string, cooked, yellow/fat</td> </tr> <tr> <td>7520498</td> <td>Beans, string, cooked, NS color/fat added</td> <td>7540301</td> <td>Beans, string, green, creamed</td> </tr> <tr> <td>7520499</td> <td>Beans, string, cooked, NS color/no fat</td> <td>7540302</td> <td>Beans, string, green, w/mushroom sauce</td> </tr> <tr> <td>7520500</td> <td>Beans, string, cooked, NS color &amp; fat</td> <td>7540401</td> <td>Beans, string, yellow, creamed</td> </tr> <tr> <td>7520501</td> <td>Beans, string, cooked, green/NS fat</td> <td>7550011</td> <td>Beans, string, green, pickled</td> </tr> <tr> <td>7520502</td> <td>Beans, string, cooked, green/no fat</td> <td>7640100</td> <td>Beans, green, string, baby</td> </tr> <tr> <td>7520503</td> <td>Beans, string, cooked, green/fat</td> <td>7640101</td> <td>Beans, green, string, baby, str.</td> </tr> <tr> <td>7520511</td> <td>Beans, str., canned, low sod.,green/NS fat</td> <td>7640102</td> <td>Beans, green, string, baby, junior</td> </tr> <tr> <td>7520512</td> <td>Beans, str., canned, low sod.,green/no fat</td> <td>7640103</td> <td>Beans, green, string, baby, creamed</td> </tr> <tr> <td>7520513</td> <td>Beans, str., canned, low sod.,green/fat</td> <td colspan="2">(does not include vegetable soups; vegetable mixtures; or vegetable with meat mixtures; includes baby foods)</td> </tr> <tr> <td>7520600</td> <td>Beans, string, cooked, yellow/NS fat</td> <td colspan="2"></td> </tr> <tr> <td>7520601</td> <td>Beans, string, cooked, yellow/no fat</td> <td colspan="2"></td> </tr> </table>	7510180	Beans, string, green, raw	7520602	Beans, string, cooked, yellow/fat	7520498	Beans, string, cooked, NS color/fat added	7540301	Beans, string, green, creamed	7520499	Beans, string, cooked, NS color/no fat	7540302	Beans, string, green, w/mushroom sauce	7520500	Beans, string, cooked, NS color & fat	7540401	Beans, string, yellow, creamed	7520501	Beans, string, cooked, green/NS fat	7550011	Beans, string, green, pickled	7520502	Beans, string, cooked, green/no fat	7640100	Beans, green, string, baby	7520503	Beans, string, cooked, green/fat	7640101	Beans, green, string, baby, str.	7520511	Beans, str., canned, low sod.,green/NS fat	7640102	Beans, green, string, baby, junior	7520512	Beans, str., canned, low sod.,green/no fat	7640103	Beans, green, string, baby, creamed	7520513	Beans, str., canned, low sod.,green/fat	(does not include vegetable soups; vegetable mixtures; or vegetable with meat mixtures; includes baby foods)		7520600	Beans, string, cooked, yellow/NS fat			7520601	Beans, string, cooked, yellow/no fat														
7510180	Beans, string, green, raw	7520602	Beans, string, cooked, yellow/fat																																																										
7520498	Beans, string, cooked, NS color/fat added	7540301	Beans, string, green, creamed																																																										
7520499	Beans, string, cooked, NS color/no fat	7540302	Beans, string, green, w/mushroom sauce																																																										
7520500	Beans, string, cooked, NS color & fat	7540401	Beans, string, yellow, creamed																																																										
7520501	Beans, string, cooked, green/NS fat	7550011	Beans, string, green, pickled																																																										
7520502	Beans, string, cooked, green/no fat	7640100	Beans, green, string, baby																																																										
7520503	Beans, string, cooked, green/fat	7640101	Beans, green, string, baby, str.																																																										
7520511	Beans, str., canned, low sod.,green/NS fat	7640102	Beans, green, string, baby, junior																																																										
7520512	Beans, str., canned, low sod.,green/no fat	7640103	Beans, green, string, baby, creamed																																																										
7520513	Beans, str., canned, low sod.,green/fat	(does not include vegetable soups; vegetable mixtures; or vegetable with meat mixtures; includes baby foods)																																																											
7520600	Beans, string, cooked, yellow/NS fat																																																												
7520601	Beans, string, cooked, yellow/no fat																																																												
Beef	<table border="0"> <tr> <td>21-</td> <td>Beef</td> <td colspan="2">(excludes meat, poultry, and fish with non-meat items; frozen plate meals; soups and gravies with meat, poultry and fish base; and gelatin-based drinks; includes baby food)</td> </tr> <tr> <td></td> <td>beef, nfs</td> <td colspan="2"></td> </tr> <tr> <td></td> <td>beef steak</td> <td colspan="2"></td> </tr> <tr> <td></td> <td>beef oxtails, neckbones, ribs</td> <td colspan="2"></td> </tr> <tr> <td></td> <td>roasts, stew meat, corned, brisket, sandwich steaks</td> <td colspan="2"></td> </tr> <tr> <td></td> <td>ground beef, patties, meatballs</td> <td colspan="2"></td> </tr> <tr> <td></td> <td>other beef items</td> <td colspan="2"></td> </tr> <tr> <td></td> <td>beef baby food</td> <td colspan="2"></td> </tr> </table>	21-	Beef	(excludes meat, poultry, and fish with non-meat items; frozen plate meals; soups and gravies with meat, poultry and fish base; and gelatin-based drinks; includes baby food)			beef, nfs				beef steak				beef oxtails, neckbones, ribs				roasts, stew meat, corned, brisket, sandwich steaks				ground beef, patties, meatballs				other beef items				beef baby food																														
21-	Beef	(excludes meat, poultry, and fish with non-meat items; frozen plate meals; soups and gravies with meat, poultry and fish base; and gelatin-based drinks; includes baby food)																																																											
	beef, nfs																																																												
	beef steak																																																												
	beef oxtails, neckbones, ribs																																																												
	roasts, stew meat, corned, brisket, sandwich steaks																																																												
	ground beef, patties, meatballs																																																												
	other beef items																																																												
	beef baby food																																																												



Appendix 9B. Food Codes and Definitions Used in Analysis of the 1989-91 USDA CSFII Data (continued)		
Food Product	Food Codes	
Pork	22- Pork pork, nfs; ground dehydrated chops steaks, cutlets ham roasts Canadian bacon bacon, salt pork other pork items pork baby food	(excludes meat, poultry, and fish with non-meat items; frozen plate meals; soups and gravies with meat, poultry and fish base; and gelatin-based drinks; includes baby food)
Game	233- Game	(excludes meat, poultry, and fish with non-meat items; frozen plate meals; soups and gravies with meat, poultry and fish base; and gelatin-based drinks)
Poultry	24- Poultry chicken turkey duck other poultry poultry baby food	(excludes meat, poultry, and fish with non-meat items; frozen plate meals; soups and gravies with meat, poultry and fish base; and gelatin-based drinks; includes baby food)
Eggs	3- Eggs eggs egg mixtures egg substitutes eggs baby food froz. meals with egg as main ingred.	(includes baby foods)
Broccoli	722- Broccoli (all forms)	(does not include vegetable soups; vegetable mixtures; or vegetable with meat mixtures)
Carrots	7310- Carrots (all forms) 7311140 Carrots in Sauce 7311200 Carrot Chips 76201- Carrots, baby	(does not include vegetable soups; vegetable mixtures; or vegetable with meat mixtures; includes baby foods except mixtures)
Pumpkin	732- Pumpkin (all forms) 733- Winter squash (all forms) 76205- Squash, baby	(does not include vegetable soups; vegetables mixtures; or vegetable with meat mixtures; includes baby foods)
Asparagus	7510080 Asparagus, raw 75202- Asparagus, cooked 7540101 Asparagus, creamed or with cheese	(does not include vegetable soups; vegetables mixtures, or vegetable with meat mixtures)
Lima Beans	7510200 Lima Beans, raw 752040- Lima Beans, cooked 752041- Lima Beans, canned 75402- Lima Beans with sauce	(does not include vegetable soups; vegetable mixtures; or vegetable with meat mixtures; does not include succotash)
Cabbage	7510300 Cabbage, raw 7510400 Cabbage, Chinese, raw 7510500 Cabbage, red, raw 7514100 Cabbage salad or coleslaw 7514130 Cabbage, Chinese, salad 75210- Chinese Cabbage, cooked 75211- Green Cabbage, cooked	75212- Red Cabbage, cooked 752130- Savoy Cabbage, cooked 75230- Sauerkraut, cooked 7540701 Cabbage, creamed 755025- Cabbage, pickled or in relish (does not include vegetable soups; vegetable mixtures; or vegetable with meat mixtures)



Appendix 9B

Appendix 9B. Food Codes and Definitions Used in Analysis of the 1989-91 USDA CSFII Data (continued)		
Food Product	Food Codes	
Lettuce	75113- Lettuce, raw 75143- Lettuce salad with other veg. 7514410 Lettuce, wilted, with bacon dressing 7522005 Lettuce, cooked	(does not include vegetable soups; vegetable mixtures; or vegetable with meat mixtures)
Okra	7522000 Okra, cooked, NS as to fat 7522001 Okra, cooked, fat not added 7522002 Okra, cooked, fat added 7522010 Lufta, cooked (Chinese Okra)	7541450 Okra, fried 7550700 Okra, pickled (does not include vegetable soups; vegetable mixtures; or vegetable with meat mixtures)
Peas	7512000 Peas, green, raw 7512775 Snowpeas, raw 75223- Peas, cowpeas, field or blackeye, cooked 75224- Peas, green, cooked 75225- Peas, pigeon, cooked 75231- Snowpeas, cooked 7541650 Pea salad	7541660 Pea salad with cheese 75417- Peas, with sauce or creamed 76409- Peas, baby 76411- Peas, creamed, baby (does not include vegetable soups; vegetable mixtures; or vegetable with meat mixtures; includes baby foods except mixtures)
Cucumbers	7511100 Cucumbers, raw 75142- Cucumber salads 752167- Cucumbers, cooked 7550301 Cucumber pickles, dill 7550302 Cucumber pickles, relish 7550303 Cucumber pickles, sour 7550304 Cucumber pickles, sweet	7550305 Cucumber pickles, fresh 7550307 Cucumber, Kim Chee 7550311 Cucumber pickles, dill, reduced salt 7550314 Cucumber pickles, sweet, reduced salt (does not include vegetable soups; vegetable mixtures; or vegetable with meat mixtures)
Beets	7510250 Beets, raw 752080- Beets, cooked 752081- Beets, canned 7540501 Beets, harvard	7550021 Beets, pickled 76403- Beets, baby (does not include vegetable soups; vegetable mixtures; or vegetable with meat mixtures; includes baby foods except mixtures)
Strawberries	6322- Strawberries 6413250 Strawberry Juice	(includes baby food; except mixtures)
Other Berries	6320- Other Berries 6321- Other Berries 6341101 Cranberry salad	6410460 Blackberry Juice 64105- Cranberry Juice (includes baby food; except mixtures)
Peaches	62116- Dried Peaches 63135- Peaches 6412203 Peach Juice 6420501 Peach Nectar	67108- Peaches ,baby 6711450 Peaches, dry, baby (includes baby food; except mixtures)
Pears	62119- Dried Pears 63137- Pears 6341201 Pear salad 6421501 Pear Nectar	67109- Pears, baby 6711455 Pears, dry, baby 6721200 Pear juice, baby (includes baby food; except mixtures)





Appendix 9B. Food Codes and Definitions Used in Analysis of the 1989-91 USDA CSFII Data (continued)

Food Product	Food Codes	
<b>EXPOSED/PROTECTED FRUITS/VEGETABLES, ROOT VEGETABLES</b>		
Exposed Fruits	621011- Apple, dried 621012- Apple, dried 6210130 Apple chips 62104- Apricot, dried 62108- Currants, dried 62110- Date, dried 62116- Peaches, dried 62119- Pears, dried 62121- Plum, dried 62122- Prune, dried 62125- Raisins 63101- Apples/applesauce 63102- Wi-apple 63103- Apricots 63111- Cherries, maraschino 63112- Acerola 63113- Cherries, sour 63115- Cherries, sweet 63117- Currants, raw 63123- Grapes 6312601 Juneberry 63131- Nectarine 63135- Peach 63137- Pear 63139- Persimmons	63143- Plum 63146- Quince 63147- Rhubarb/Sapodillo 632- Berries 64101- Apple Cider 64104- Apple Juice 6410409 Apple juice with calcium 64105- Cranberry Juice 64116- Grape Juice 64122- Peach Juice 64132- Prune/Strawberry Juice 6420101 Apricot Nectar 64205- Peach Nectar 64215- Pear Nectar 67102- Applesauce, baby 67108- Peaches, baby 67109- Pears, baby 6711450 Peaches, baby, dry 6711455 Pears, baby, dry 67202- Apple Juice, baby 6720380 White Grape Juice, baby 67212- Pear Juice, baby (includes baby foods/juices except mixtures; excludes fruit mixtures)
Protected Fruits	61- Citrus Fr., Juices (incl. cit. juice mixtures) 62107- Bananas, dried 62113- Figs, dried 62114- Lychees/Papayas, dried 62120- Pineapple, dried 62126- Tamarind, dried 63105- Avocado, raw 63107- Bananas 63109- Cantaloupe, Carambola 63110- Cassaba Melon 63119- Figs 63121- Genip 63125- Guava/Jackfruit, raw 6312650 Kiwi 6312651 Lychee, raw 6312660 Lychee, cooked 63127- Honeydew 63129- Mango 63133- Papaya 63134- Passion Fruit 63141- Pineapple	63145- Pomegranate 63148- Sweetsop, Soursop, Tamarind 63149- Watermelon 64120- Papaya Juice 64121- Passion Fruit Juice 64124- Pineapple Juice 64125- Pineapple juice 64133- Watermelon Juice 6420150 Banana Nectar 64202- Cantaloupe Nectar 64203- Guava Nectar 64204- Mango Nectar 64210- Papaya Nectar 64213- Passion Fruit Nectar 64221- Soursop Nectar 6710503 Bananas, baby 6711500 Bananas, baby, dry 6720500 Orange Juice, baby 6721300 Pineapple Juice, baby (includes baby foods/juices except mixtures; excludes fruit mixtures)



Appendix 9B

Appendix 9B. Food Codes and Definitions Used in Analysis of the 1989-91 USDA CSFII Data (continued)	
Food Product	Food Codes
Exposed Veg.	721- Dark Green Leafy Veg.
	722- Dark Green Nonleafy Veg.
	74- Tomatoes and Tomato Mixtures
	7510050 Alfalfa Sprouts
	7510075 Artichoke, Jerusalem, raw
	7510080 Asparagus, raw
	75101- Beans, sprouts and green, raw
	7510260 Broccoli, raw
	7510275 Brussel Sprouts, raw
	7510280 Buckwheat Sprouts, raw
	7510300 Cabbage, raw
	7510400 Cabbage, Chinese, raw
	7510500 Cabbage, Red, raw
	7510700 Cauliflower, raw
	7510900 Celery, raw
	7510950 Chives, raw
	7511100 Cucumber, raw
	7511120 Eggplant, raw
	7511200 Kohlrabi, raw
	75113- Lettuce, raw
	7511500 Mushrooms, raw
	7511900 Parsley
	7512100 Pepper, hot chili
	75122- Peppers, raw
	7512750 Seaweed, raw
	7512775 Snowpeas, raw
	75128- Summer Squash, raw
	7513210 Celery Juice
	7514100 Cabbage or cole slaw
	7514130 Chinese Cabbage Salad
	7514150 Celery with cheese
	75142- Cucumber salads
	75143- Lettuce salads
	7514410 Lettuce, wilted with bacon dressing
	7514600 Greek salad
	7514700 Spinach salad
	7520060 Algae, dried
	75201- Artichoke, cooked
	75202- Asparagus, cooked
	75203- Bamboo shoots, cooked
	752049- Beans, string, cooked
	75205- Beans, green, cooked/canned
	75206- Beans, yellow, cooked/canned
	75207- Bean Sprouts, cooked
	752085- Breadfruit
	752087- Broccoli, cooked
	752090- Brussel Sprouts, cooked
	75210- Cabbage, Chinese, cooked
	75211- Cabbage, green, cooked
	75212- Cabbage, red, cooked
752130- Cabbage, savoy, cooked	
75214- Cauliflower	
75215- Celery, Chives, Christophine (chayote)	
752167- Cucumber, cooked	
752170- Eggplant, cooked	
752171- Fern shoots	
752172- Fern shoots	
752173- Flowers of sesbania, squash or lily	
7521801 Kohlrabi, cooked	
75219- Mushrooms, cooked	
75220- Okra/lettuce, cooked	
7522116 Palm Hearts, cooked	
7522121 Parsley, cooked	
75226- Peppers, pimento, cooked	
75230- Sauerkraut, cooked/canned	
75231- Snowpeas, cooked	
75232- Seaweed	
75233- Summer Squash	
7540050 Artichokes, stuffed	
7540101 Asparagus, creamed or with cheese	
75403- Beans, green with sauce	
75404- Beans, yellow with sauce	
7540601 Brussel Sprouts, creamed	
7540701 Cabbage, creamed	
75409- Cauliflower, creamed	
75410- Celery/Chiles, creamed	
75412- Eggplant, fried, with sauce, etc.	
75413- Kohlrabi, creamed	
75414- Mushrooms, Okra, fried, stuffed, creamed	
754180- Squash, baked, fried, creamed, etc.	
7541822 Christophine, creamed	
7550011 Beans, pickled	
7550051 Celery, pickled	
7550201 Cauliflower, pickled	
755025- Cabbage, pickled	
7550301 Cucumber pickles, dill	
7550302 Cucumber pickles, relish	
7550303 Cucumber pickles, sour	
7550304 Cucumber pickles, sweet	
7550305 Cucumber pickles, fresh	
7550307 Cucumber, Kim Chee	
7550308 Eggplant, pickled	
7550311 Cucumber pickles, dill, reduced salt	
7550314 Cucumber pickles, sweet, reduced salt	
7550500 Mushrooms, pickled	
7550700 Okra, pickled	
75510- Olives	
7551101 Peppers, hot	
7551102 Peppers, pickled	
7551104 Peppers, hot pickled	
7551301 Seaweed, pickled	
7553500 Zucchini, pickled	
76102- Dark Green Veg., baby	
76401- Beans, baby (excl. most soups & mixtures)	
411- Beans/legumes	
412- Beans/legumes	
413- Beans/legumes	



Appendix 9B. Food Codes and Definitions Used in Analysis of the 1989-91 USDA CSFII Data (continued)			
Food Product	Food Codes		
Protected Veg.	732- Pumpkin 733- Winter Squash 7510200 Lima Beans, raw 7510550 Cactus, raw 7510960 Corn, raw 7512000 Peas, raw 7520070 Aloe vera juice 752040- Lima Beans, cooked 752041- Lima Beans, canned 7520829 Bitter Melon 752083- Bitter Melon, cooked 7520950 Burdock 752131- Cactus 752160- Corn, cooked 752161- Corn, yellow, cooked 752162- Corn, white, cooked 752163- Corn, canned 7521749 Hominy	752175- Hominy 75223- Peas, cowpeas, field or blackeye, cooked 75224- Peas, green, cooked 75225- Peas, pigeon, cooked 75301- Succotash 75402- Lima Beans with sauce 75411- Corn, scalloped, fritter, with cream 7541650 Pea salad 7541660 Pea salad with cheese 75417- Peas, with sauce or creamed 7550101 Corn relish 76205- Squash, yellow, baby 76405- Corn, baby 76409- Peas, baby 76411- Peas, creamed, baby (does not include vegetable soups; vegetable mixtures; or vegetable with meat mixtures)	
Root Vegetables	71- White Potatoes and Puerto Rican St. Veg. 7310- Carrots 7311140 Carrots in sauce 7311200 Carrot chips 734- Sweetpotatoes 7510250 Beets, raw 7511150 Garlic, raw 7511180 Jicama (yambean), raw 7511250 Leeks, raw 75117- Onions, raw 7512500 Radish, raw 7512700 Rutabaga, raw 7512900 Turnip, raw 752080- Beets, cooked 752081- Beets, canned 7521362 Cassava 7521740 Garlic, cooked 7521771 Horseradish 7521840 Leek, cooked 7521850 Lotus root 752210- Onions, cooked	7522110 Onions, dehydrated 752220- Parsnips, cooked 75227- Radishes, cooked 75228- Rutabaga, cooked 75229- Salsify, cooked 75234- Turnip, cooked 75235- Water Chestnut 7540501 Beets, harvard 75415- Onions, creamed, fried 7541601 Parsnips, creamed 7541810 Turnips, creamed 7550021 Beets, pickled 7550309 Horseradish 7551201 Radishes, pickled 7553403 Turnip, pickled 76201- Carrots, baby 76209- Sweetpotatoes, baby 76403- Beets, baby (does not include vegetable soups; vegetable mixtures; or vegetable with meat mixtures)	
<b>USDA SUBCATEGORIES</b>			
Dark Green Vegetables	72- Dark Green Vegetables all forms leafy, nonleafy, dk. gr. veg. soups		
Deep Yellow Vegetables	73- Deep Yellow Vegetables all forms carrots, pumpkin, squash, sweetpotatoes, dp. yell. veg. soups		
Other Vegetables	75- Other Vegetables all forms		
Citrus Fruits	61- Citrus Fruits and Juices 6720500 Orange Juice, baby food 6720600 Orange-Apricot Juice, baby food	6720700 Orange-Pineapple Juice, baby food 6721100 Orange-Apple-Banana Juice, baby food (excludes dried fruits)	
Appendix 9B. Food Codes and Definitions Used in Analysis of the 1989-91 USDA CSFII Data (continued)			



*Appendix 9B*

Food Product	Food Codes	
Other Fruits	62- Dried Fruits 63- Other Fruits 64- Fruit Juices and Nectars Excluding Citrus 671- Fruits, baby 67202- Apple Juice, baby 67203- Baby Juices	67204- Baby Juices 67212- Baby Juices 67213- Baby Juices 6725- Baby Juice 673- Baby Fruits 674- Baby Fruits
<b>MIXTURES</b>		
Meat Mixtures	27- Meat Mixtures (includes frozen plate meals and soups) 28-	
Grain Mixtures	58- Grain Mixtures (includes frozen plate meals and soups)	

## TABLE OF CONTENTS

	<u>Page No.</u>
10. INTAKE OF FISH AND SHELLFISH .....	1
10.1. BACKGROUND .....	1
10.2. KEY GENERAL POPULATION STUDIES .....	2
10.3. RELEVANT GENERAL POPULATION STUDIES .....	6
10.4. KEY RECREATIONAL (MARINE FISH STUDIES) .....	8
10.5. RELEVANT RECREATIONAL MARINE STUDIES .....	10
10.6. KEY FRESHWATER RECREATIONAL STUDIES .....	12
10.7. RELEVANT FRESHWATER RECREATIONAL STUDIES .....	18
10.8. NATIVE AMERICAN FRESHWATER STUDIES .....	20
10.9. OTHER FACTORS .....	24
10.10. RECOMMENDATIONS .....	25
10.10.1. Recommendations - General Population .....	25
10.10.2. Recommendations - Recreational Marine Anglers .....	26
10.10.3. Recommendations - Recreational Freshwater Anglers .....	26
<b>10.10.4. Recommendations - Native American                     Subsistence Populations</b> .....	26
10.11. REFERENCES FOR CHAPTER 10 .....	27



## **10. INTAKE OF FISH AND SHELLFISH**

### **10.1. BACKGROUND**

Contaminated finfish and shellfish are potential sources of human exposure to toxic chemicals. Pollutants are carried in the surface waters, but also may be stored and accumulated in the sediments as a result of complex physical and chemical processes. Consequently, finfish and shellfish are exposed to these pollutants and may become sources of contaminated food.

Accurately estimating exposure to a toxic chemical among a population that consumes fish from a polluted water body requires an estimation of intake rates of the caught fish by both fishermen and their families. Commercially caught fish are marketed widely, making the prediction of an individual's consumption from a particular commercial source difficult. Since the catch of recreational and subsistence fishermen is not "diluted" in this way, these individuals and their families represent the population that is most vulnerable to exposure by intake of contaminated fish from a specific location.

This section focuses on intake rates of fish. Note that in this section the term fish refers to both finfish and shellfish. The following subsections address intake rates for the general population, and recreational and subsistence fishermen. Data are presented for intake rates for both marine and freshwater fish, when available. The available studies have been classified as either key or relevant based on the guidelines given in Volume I, Section 1.3. Recommended intake rates are based on the results of key studies, but other relevant studies are also presented to provide the reader with added perspective on the current state-of-knowledge pertaining to fish intake.

Survey data on fish consumption have been collected using a number of different approaches which need to be considered in interpreting the survey results. Generally, surveys are either "creel" studies in which fishermen are interviewed while fishing, or broader population surveys using either mailed questionnaires or phone interviews. Both types of data can be useful for exposure assessment purposes, but somewhat different applications and interpretations are needed. In fact, results from creel studies have often been misinterpreted, due to inadequate knowledge of survey principles. Below, some basic facts about survey design are presented, followed by an analysis of the differences between creel and population based studies.

The typical survey seeks to draw inferences about a larger population from a smaller sample of that population. This larger population, from which the survey

sample is to be taken and to which the results of the survey are to be generalized, is denoted the target population of the survey. In order to generalize from the sample to the target population, the probability of being sampled must be known for each member of the target population. This probability is reflected in weights assigned to each survey respondent, with weights being inversely proportional to sampling probability. When all members of the target population have the same probability of being sampled, all weights can be set to one and essentially ignored.

In a mail or phone study of licensed anglers, the target population is generally all licensed anglers in a particular area, and in the studies presented, the sampling probability is essentially equal for all target population members. In a creel study, the target population is anyone who fishes at the locations being studied; generally, in a creel study, the probability of being sampled is not the same for all members of the target population. For instance, if the survey is conducted for one day at a site, then it will include all persons who fish there daily but only about 1/7 of the people who fish there weekly, 1/30th of the people who fish there monthly, etc. In this example, the probability of being sampled (or inverse weight) is seen to be proportional to the frequency of fishing. However, if the survey involves interviewers revisiting the same site on multiple days, and persons are only interviewed once for the survey, then the probability of being in the survey is not proportional to frequency; in fact, it increases less than proportionally with frequency. At the extreme of surveying the same site every day over the survey period with no re-interviewing, all members of the target population would have the same probability of being sampled regardless of fishing frequency, implying that the survey weights should all equal one.

On the other hand, if the survey protocol calls for individuals to be interviewed each time an interviewer encounters them (i.e., without regard to whether they were previously interviewed), then the inverse weights will again be proportional to fishing frequency, no matter how many times interviewers revisit the same site. Note that when individuals can be interviewed multiple times, the results of each interview are included as separate records in the data base and the survey weights should be inversely proportional to the expected number of times that an individual's interviews are included in the data base.

In the published analyses of most creel studies, there is no mention of sampling weights; by default all



weights are set to 1, implying equal probability of sampling. However, since the sampling probabilities in a creel study, even with repeated interviewing at a site, are highly dependent on fishing frequency, the fish intake distributions reported for these surveys are not reflective of the corresponding target populations. Instead, those individuals with high fishing frequencies are given too big a weight and the distribution is skewed to the right, i.e., it overestimates the target population distribution.

Price et al. (1994) explained this problem and set out to rectify it by adding weights to creel survey data; he used data from two creel studies (Puffer et al., 1981 and Pierce et al., 1981) as examples. Price et al. (1994) used inverse fishing frequency as survey weights and produced revised estimates of median and 95th percentile intake for the above two studies. These revised estimates were dramatically lower than the original estimates. The approach of Price et al. (1994) is discussed in more detail in Section 10.5 where the Puffer et al. (1981) and Pierce et al. (1981) studies are summarized.

When the correct weights are applied to survey data, the resulting percentiles reflect, on average, the distribution in the target population; thus, for example, an estimated 90 percent of the target population will have intake levels below the 90th percentile of the survey fish intake distribution. There is another way, however, of characterizing distributions in addition to the standard percentile approach; this approach is reflected in statements of the form "50 percent of the income is received by, for example, the top 10 percent of the population, which consists of individuals making more than \$100,000", for example. Note that the 50th percentile (median) of the income distribution is well below \$100,000. Here the \$100,000 level can be thought of as, not the 50th percentile of the population income distribution, but as the 50th percentile of the "resource utilization distribution" (see Appendix 10A for technical discussion of this distribution). Other percentiles of the resource utilization distribution have similar interpretations; e.g., the 90th percentile of the resource utilization distribution (for income) would be that level of income such that 90 percent of total income is received by individuals with incomes below this level and 10 percent by individuals with income above this level. This alternative approach to characterizing distributions is of particular interest when a relatively small fraction of individuals consumes a relatively large fraction of a resource, which is the case with regards to recreational fish consumption. In the studies of recreational anglers,

this alternative approach, based on resource utilization, will be presented, where possible, in addition to the primary approach of presenting the standard percentiles of the fish intake distribution.

It has been determined that the resource utilization approach to characterizing distributions has relevance to the interpretation of creel survey data. As mentioned above, most published analyses of creel surveys do not employ weights reflective of sampling probability, but instead give each respondent equal weight. For mathematical reasons that are explained in Appendix 10A, when creel analyses are performed in this (equal weighting) manner, the calculated percentiles of the fish intake distribution do not reflect the percentiles of the target population fish intake distribution but instead reflect (approximately) the percentiles of the "resource utilization distribution". Thus, one would not expect 50 percent of the target population to be consuming above the median intake level as reported from such a creel survey, but instead would expect that 50 percent of the total recreational fish consumption would be individuals consuming above this level. As with the example above, and in accordance with the statement above that creel surveys analyzed in this manner overestimate intake distributions, the actual median level of intake in the target population will be less (probably considerably so) than this level and, accordingly, (considerably) less than 50 percent of the target population will be consuming at or above this level. These considerations are discussed when the results of individual creel surveys are presented in later sections and should be kept in mind whenever estimates based on creel survey data are utilized.

The U.S. EPA has prepared a review of and an evaluation of five different survey methods used for obtaining fish consumption data. They are:

- Recall-Telephone Survey;
- Recall-Mail Survey;
- Recall-Personal Interview;
- Diary; and
- Creel Census.

The reader is referred to *U.S. EPA 1992-Consumption Surveys for Fish and Shellfish* for more detail on these survey methods and their advantages and limitations.

## **10.2. KEY GENERAL POPULATION STUDIES**

*Tuna Research Institute Survey* - The Tuna Research Institute (TRI) funded a study of fish



consumption which was performed by the National Purchase Diary (NPD) during the period of September, 1973 to August, 1974. The data tapes from this survey were obtained by the National Marine Fisheries Service (NMFS), which later, along with the FDA, USDA and TRI, conducted an intensive effort to identify and correct errors in the data base. Javitz (1980) summarized the TRI survey methodology and used the corrected tape to generate fish intake distributions for various sub-populations.

The TRI survey sample included 6,980 families who were currently participating in a syndicated national purchase diary panel, 2,400 additional families where the head of household was female and under 35 years old; and 210 additional black families (Javitz, 1980). Of the 9,590 families in the total sample, 7,662 families (25,162 individuals) completed the questionnaire, a response rate of 80 percent. The survey was weighted to represent the U.S. population based on a number of census-defined controls (i.e., census region, household size, income, presence of children, race and age). The calculations of means, percentiles, etc. were performed on a weighted basis with each person contributing in proportion to his/her assigned survey weight.

The survey population was divided into 12 different sample segments and, for each of the 12 survey months, data were collected from a different segment. Each survey household was given a diary in which they recorded, over a one month period, the date of any fish meals consumed and the following accompanying information: the species of fish consumed, whether the fish was commercially or recreationally caught, the way the fish was packaged (canned, frozen fresh, dried, smoked), the amount of fish prepared and consumed, and the number of servings consumed by household members and guests. Both meals eaten at home and away from home were recorded. The amount of fish prepared was determined as follows (Javitz, 1980): "For fresh fish, the weight was recorded in ounces and may have included the weight of the head and tail. For frozen fish, the weight was recorded in packaged ounces, and it was noted whether the fish was breaded or combined with other ingredients (e.g., TV dinners). For canned fish, the weight was recorded in packaged ounces and it was noted whether the fish was canned in water, oil, or with other ingredients (e.g., soups)".

Javitz (1980) reported that the corrected survey tapes contained data on 24,652 individuals who consumed fish in the survey month and that tabulations performed by

NPD indicated that these fish consumers represented 94 percent of the U.S. population. For this population of "fish consumers", Javitz (1980) calculated means and percentiles of fish consumption by demographic variables (age, sex, race, census region and community type) and overall (Tables 10-1 through 10-4). The overall mean fish intake rate among fish consumers was calculated at 14.3 g/day and the 95th percentile at 41.7 g/day.

As seen in Table 10-1, the mean and 95th percentile of fish consumption were higher for Asian-Americans as compared to the other racial groups. Other differences in intake rates are those between gender and age groups. While males (15.6 g/d) eat slightly more fish than females (13.2 g/d), and adults eat more fish than children, the corresponding differences in body weight would probably compensate for the different intake rates in exposure calculations (Javitz, 1980). There appeared to be no large differences in regional intake rates, although higher rates are shown in the New England and Middle Atlantic census regions.

The mean and 95th percentile intake rates by age-gender groups are presented in Table 10-2. Tables 10-3 and 10-4 present the distribution of fish consumption for females and males, respectively, by age; these tables give the percentages of females/males in a given age bracket with intake rates within various ranges. Table 10-5 presents mean total fish consumption by fish species.

The TRI survey data were also utilized by Rupp et al. (1980) to generate fish intake distributions for three age groups (<11, 12-18, and 19+ years) within each of the 9 census regions and for the entire United States. Separate distributions were derived for freshwater finfish, saltwater finfish and shellfish; thus, a total of 90 (3\*3\*10) different distributions were derived, each corresponding to intake of a specific category of fish for a given age group within a given region. The analysis of Rupp et al. (1980) included only those respondents with known age. This amounted to 23,213 respondents.

Ruffle et al. (1994) used the percentiles data of Rupp et al. (1980) to estimate the best fitting lognormal parameters for each distribution. Three methods (non-linear optimization, first probability plot and second probability plot) were used to estimate optimal parameters. Ruffle et al. (1994) determined that, of the three methods, the non-linear optimization method (NLO) generally gave the best results. For some of the distributions fitted by the NLO method, however, it was determined that the lognormal model did not adequately fit the empirical fish intake distribution. Ruffle et al.





(1994) used a criterion of minimum sum of squares (min SS) less than 30 to identify which distributions provided adequate fits. Of the 90 distributions studied, 77 were seen to have min SS < 30; for these, Ruffle et al. (1994) concluded that the NLO modeled lognormal distributions are “well suited for risk assessment”. Of the remaining 13 distributions, 12 had min SS > 30; for these Ruffle et al. (1994) concluded that modeled lognormal distributions “may also be appropriate for use when exercised with due care and with sensitivity analyses”. One distribution, that of freshwater finfish intake for children < 11 years of age in New England, could not be modeled due to the absence of any reported consumption.

Table 10-6 presents the optimal lognormal parameters, the mean ( $\mu$ ), standard deviation (s), and min SS, for all 89 modeled distributions. These parameters can be used to determine percentiles of the corresponding distribution of average daily fish consumption rates through the relation  $DFC(p) = \exp[\mu + z(p)s]$  where  $DFC(p)$  is the pth percentile of the distribution of average daily fish consumption rates and  $z(p)$  is the z-score associated with the pth percentile (e.g.,  $z(50) = 0$ ). The mean average daily fish consumption rate is given by  $\exp[\mu + 0.5s^2]$ .

The analyses of Javitz (1980) and Ruffle et al. (1994) were based on consumers only, who are estimated to represent 94.0 percent of the U.S. population. U.S. EPA estimated the mean intake in the general population by multiplying the fraction consuming, 0.94, by the mean among consumers reported by Javitz (1980) of 14.3 g/day; the resulting estimate is 13.4 g/day. The 95th percentile estimate of Javitz (1980) of 41.7 g/day among consumers would be essentially unchanged when applied to the general population; 41.7 g/day would represent the 95.3 percentile (i.e.,  $100 * [0.95 * 0.94 + 0.06]$ ) among the general population.

Advantages of the TRI data survey are that it was a large, nationally representative survey with a high response rate (80 percent) and was conducted over an entire year. In addition, consumption was recorded in a daily diary over a one month period; this format should be more reliable than one based on one-month recall. The upper percentiles presented are derived from one month of data, and are likely to overestimate the corresponding upper percentiles of the long-term (i.e., one year or more) average daily fish intake distribution. Similarly, the standard deviation of the fitted lognormal distribution probably overestimates the standard deviation of the long-term distribution. However, the period of this survey (one month) is considerably longer than those of many

other consumption studies, including the USDA National Food Consumption Surveys, which report consumption over a 3 day to one week period.

Another obvious limitation of this data base is that it is now over twenty years out of date. Ruffle et al. (1994) considered this shortcoming and suggested that one may wish to shift the distribution upward to account for the recent increase in fish consumption. Adding  $\ln(1+x/100)$  to the log mean  $\mu$  will shift the distribution upward by x percent (e.g., adding  $0.22 = \ln(1.25)$  increases the distribution by 25 percent). Although the TRI survey distinguished between recreationally and commercially caught fish, Javitz (1980), Rupp et al. (1980), and Ruffle et al. (1994) (which was based on Rupp et al., 1980) did not present analyses by this variable.

*U.S. EPA (1996a) - Daily Average Per Capita Fish Consumption Estimates Based on the Combined USDA 1989, 1990, and 1991 Continuing Survey of Food Intakes by Individuals (CSFII)* — The USDA conducts the CSFII on an ongoing basis. U.S. EPA used the 1989, 1990, and 1991 CSFII data to generate fish intake estimates. Participants in the CSFII provided 3 consecutive days of dietary data. For the first day's data, participants supplied dietary recall information to an in-home interviewer. Second and third day dietary intakes were recorded by participants. Data collection for the CSFII started in April of the given year and was completed in March of the following year.

The CSFII contains 469 fish-related food codes; survey respondents reported consumption across 284 of these codes. Respondents estimated the weight of each food that they consumed. The fish component (by weight) of these foods was calculated using data from the recipe file for release 7 of the USDA's Nutrient Data Base for Individual Food Intake Surveys. The amount of fish consumed by each individual was then calculated by summing, over all fish containing foods, the product of the weight of food consumed and the fish component (i.e., the percentage fish by weight) of the food.

The recipe file also contains cooking loss factors associated with each food. These were utilized to convert, for each fish containing food, the as-eaten fish weight consumed into an uncooked equivalent weight of fish. Analyses of fish intake were performed on both an as-eaten and uncooked basis.

Each (fish-related) food code was assigned by EPA a habitat type of either freshwater/estuarine or marine. Food codes were also designated as finfish or shellfish. Average daily individual consumption (g/day) for a given



---

**Chapter 10 - Intake of Fish and Shellfish**

---

fish type-by-habitat category (e.g., marine finfish) was calculated by summing the amount of fish consumed by the individual across the three reporting days for all fish-related food codes in the given fish-by-habitat category and then dividing by 3. Individual consumption per day consuming fish (g/day) was calculated similarly except that total fish consumption was divided by the specific number of survey days the individual reported consuming fish; this was calculated for fish consumers only (i.e., those consuming fish on at least one of the three survey days). The reported body-weight of the individual was used to convert consumption in g/day to consumption in g/kg-day.

There were a total of 11,912 respondents in the combined data set who had three-day dietary intake data. Survey weights were assigned to this data set to make it representative of the U.S. population with respect to various demographic characteristics related to food intake.

U.S. EPA (1996a) reported means, medians, upper percentiles, and 90-percent interval estimates for the 90th, 95th, and 99th percentiles. The 90-percent interval estimates are nonparametric estimates from bootstrap techniques. The bootstrap estimates result from the percentile method which estimates the lower and upper bounds for the interval estimate by the  $100\alpha$  percentile and  $100(1-\alpha)$  percentile estimates from the non-parametric distribution of the given point estimate (U.S. EPA, 1996a).

Analyses of fish intake were performed on an as-eaten as well as on an uncooked equivalent basis and on a g/day and g/kg-day basis. Table 10-7 gives the mean and various percentiles of the distribution of per-capita fish intake rates (g/day) based on uncooked equivalent weight by habitat and fish type, for the general population. The mean per capita intake rate of finfish and shellfish from all habitats was 20.1 g/day. Per-capita consumption estimates by species are shown in Appendix 10C. Table 10-8 displays the mean and various percentiles of the distribution of total fish intake per day consuming fish, by habitat for consumers only. Also displayed is the percentage of the population consuming fish of the specified habitat during the three day survey period. Tables 10-9 and 10-10 present similar results as above but on a mg/kg-day basis; Tables 10-11 and 10-12 present results in the same format for fish intake (g/day) on an as-eaten (cooked) basis.

Tables 10-13 through 10-44 present data for daily average per capita fish consumption by age and gender. These data are presented by selected age grouping (4 and

under, 15-44, 45 and older, all ages) and gender. Tables 10-13 through 10-20 present fish intake data (g/day and mg/kg-day) on an as consumed basis for the general population and Tables 10-21 through 10-28 for consumers only. Tables 10-29 through 10-44 provide intake data (g/day and mg/kg-day) on an uncooked equivalent basis for the same population groups described above.

The advantages of this study are its large size, its relative currency and its representativeness. In addition, through use of the USDA recipe files, the analysis identified all fish-related food codes and estimated the percent fish content of each of these codes. By contrast, some analyses of the USDA National Food Consumption Surveys (NFCSS) which reported per capita fish intake rates (e.g., Pao et al., 1982; USDA, 1992a), excluded certain fish containing foods (e.g., fish mixtures, frozen plate meals) in their calculations.

Results from the 1977-1978 NFCS survey (Pao et al., 1982) showed that only a small percentage of consumers ate fish on more than one occasion per day. This implies that the distribution presented for fish intake per day consuming fish can be used as a surrogate for the distribution of fish intake per (fish) eating occasion (Table 10-8).

Also, it should be noted that the 1989-91 CSFII data are not the most recent intake survey data. USDA has recently made available data from its 1994 and 1995 CSFII. Over 5,500 people nationwide participated in both of these surveys, providing recalled food intake information for two separate days. Although the 2-day data analysis has not been conducted, USDA published results for the respondents' intakes on the first day surveyed (USDA, 1996a; USDA, 1996b). USDA 1996 survey data will be made available later in 1997. As soon as 1996 data are available, EPA will take steps to get the 3-year data (1994, 1995, 1996) analyzed and the food ingestion factors updated. Meanwhile, comparisons between the mean daily fish intake per individual in a day from the USDA survey data from years 1977-78, 1987-88, 1989-91, 1994, and 1995 indicate that fish intake has been relatively constant over time. The 1-day fish intake rates were 11 g/day, 11 g/day, 13 g/day, 9 g/day, and 11 g/day for survey years 1977-78, 1987-88, 1989-91, 1994, and 1995, respectively. This indicates that the 1989-91 CSFII data presented in this handbook are probably adequate for assessing fish ingestion exposure for current populations.



### 10.3. RELEVANT GENERAL POPULATION STUDIES

*Pao et al. (1982) - Foods Commonly Eaten by Individuals: Amount Per Day and Per Eating Occasion* - The USDA 1977-78 Nationwide Food Consumption Survey (NFCS) was described in Chapter 9. The survey consisted of a household and individual component. For the individual component, all members of surveyed households were asked to provide 3 consecutive days of dietary data. For the first day's data, participants supplied dietary recall information to an in-home interviewer. Second and third day dietary intakes were recorded by participants. A total of 15,000 households were included in the 1977-78 NFCS and about 38,000 individuals completed the 3-day diet records. Fish intake was estimated based on consumption of fish products identified in the NFCS data base according to NFCS-defined food codes. These products included fresh, breaded, floured, canned, raw and dried fish, but not fish mixtures or frozen plate meals.

Pao et al. (1982) used the 1977-78 NFCS to examine the quantity of fish consumed per eating occasion. For each individual consuming fish in the 3 day survey period, the quantity of fish consumed per eating occasion was derived by dividing the total reported fish intake over the 3 day period by the number of occasions the individual reported eating fish. The distributions, by age and sex, for the quantity of fish consumed per eating occasion are displayed in Table 10-13 (Pao et al., 1982). For the general population, the average quantity of fish consumed per fish meal was 117 g, with a 95th percentile of 284 g. Males in the age groups 19-34, 35-64 and 65-74 years had the highest average and 95th percentile quantities among the age-sex groups presented.

Pao et al. (1982) also used the data from this survey set to calculate per capita fish intake rates. However, because these data are now almost 20 years out of date, this analysis is not considered key with respect to assessing per capita intake (the average quantity of fish consumed per fish meal should be less subject to change over time than is per capita intake). In addition, fish mixtures and frozen plate meals were not included in the calculation of fish intake. The per capita fish intake rate reported by Pao et al. (1982) was 11.8 g/day. The 1977-1978 NFCS was a large and well designed survey and the data are representative of the U.S. population.

*USDA Nationwide Food Consumption Survey 1987-88* - The USDA 1987-88 Nationwide Food Consumption Survey (NFCS) was described in Chapter 9.

Briefly, the survey consisted of a household and individual component. The household component asked about household food consumption over the past one week period. For the individual component, each member of a surveyed household was interviewed (in person) and asked to recall all foods eaten the previous day; the information from this interview made up the "one day data" for the survey. In addition, members were instructed to fill out a detailed dietary record for the day of the interview and the following day. The data for this entire 3-day period made up the "3-day diet records". A statistical sampling design was used to ensure that all seasons, geographic regions of the U.S., demographic, and socioeconomic groups were represented. Sampling weights were used to match the population distribution of 13 demographic characteristics related to food intake (USDA, 1992a).

Total fish intake was estimated based on consumption of fish products identified in the NFCS data base according to NFCS-defined food codes. These products included fresh, breaded, floured, canned, raw and dried fish, but not fish mixtures or frozen plate meals.

A total of 4,500 households participated in the 1987-88 survey; the household response rate was 38 percent. One day data were obtained for 10,172 (81 percent) of the 12,522 individuals in participating households; 8,468 (68 percent) individuals completed 3-day diet records.

USDA (1992b) used the one day data to derive per capita fish intake rate and intake rates for consumers of total fish. These rates, calculated by sex and age group, are shown in Table 10-14. Intake rates for consumers-only were calculated by dividing the per capita intake rates by the fractions of the population consuming fish in one day.

The 1987-1988 NFCS was also utilized to estimate consumption of home produced fish (as well as home produced fruits, vegetables, meats and dairy products) in the general U.S. population. The methodology for estimating home-produced intake rates was rather complex and involved combining the household and individual components of the NFCS; the methodology, as well as the estimated intake rates, are described in detail in Chapter 12. However, since much of the rest of this chapter is concerned with estimating consumption of recreationally caught, i.e., home produced fish, the methods and results of Chapter 12, as they pertain to fish consumption, are summarized briefly here.



A total of 2.1 percent of the survey population reported home produced fish consumption during the survey week. Among consumers, the mean intake rate was 2.07 g/kg-day and the 95th percentile was 7.83 g/kg-day; the per-capita intake rate was 0.04 g/kg-day. Note that intake rates for home-produced foods were indexed to the weight of the survey respondent and reported in g/kg-day.

It is possible to compare the estimates of home-produced fish consumption derived in this analyses with estimates derived from studies of recreational anglers (described in Sections 10.4-10.8); however, the intake rates must be put into a similar context. The home-produced intake rates described refer to average daily intake rates among individuals consuming home-produced fish in a week; results from recreational angler studies, however, usually report average daily rates for those eating home-produced fish (or for those who recreationally fish) at least some time during the year. Since many of these latter individuals eat home-produced fish at a frequency of less than once per week, the average daily intake in this group would be expected to be less than that reported.

The NFCS household component contains the question "Does anyone in your household fish?". For the population answering yes to this question (21 percent of households), the NFCS data show that 9 percent consumed home-produced fish in the week of the survey; the mean intake rate for these consumers from fishing households was 2.2 g/kg-day. (Note that 91 percent of individuals reporting home grown fish consumption for the week of the survey indicated that a household member fishes; the overall mean intake rate among home-produced fish consumers, regardless of fishing status, was the above reported 2.07 g/kg-day). The per capita intake rate among those living in a fishing household is then calculated as 0.2 g/kg-day ( $2.2 * 0.09$ ). Using the estimated average weight of survey participants of 59 kg, this translates into 11.8 g/day. Among members of fishing households, home-produced fish consumption accounted for 32.5 percent of total fish consumption.

As discussed in Chapter 12 of this volume, intake rates for home-produced foods, including fish, are based on the results of the household survey, and as such, reflect the weight of fish taken into the household. In most of the recreational fish surveys discussed later in this section, the weight of the fish catch (which generally corresponds to the weight taken into the household) is multiplied by an edible fraction to convert to an uncooked equivalent of the amount consumed. This fraction may be species specific,

but some studies used an average value; these average values ranged from 0.3 to 0.5. Using a factor of 0.5 would convert the above 11.8 g/day rate to 5.9 g/day. This estimate, 5.9 g/day, of the per-capita fish intake rate among members of fishing households is within the range of the per-capita intake rates among recreational anglers addressed in sections to follow.

An advantage of analyses based on the 1987-1988 USDA NFCS is that the data set is a large, geographically and seasonally balanced survey of a representative sample of the U.S. population. The survey response rate, however, was low and an expert panel concluded that it was not possible to establish the presence or absence of non-response bias (USDA, 1992b). Limitations of the home-produced analysis are given in Chapter 12 of this volume.

*Tsang and Klepeis (1996) - National Human Activity Pattern Survey (NHAPS)* - The U.S. EPA collected information for the general population on the duration and frequency of time spent in selected activities and time spent in selected microenvironments via 24-hour diaries. Over 9,000 individuals from 48 contiguous states participated in NHAPS. Approximately 4,700 participants also provided information on seafood consumption. The survey was conducted between October 1992 and September 1994. Data were collected on the (1) number of people that ate seafood in the last month, (2) the number of servings of seafood consumed, and (3) whether the seafood consumed was caught or purchased (Tsang and Klepeis, 1996). The participant responses were weighted according to selected demographics such as age, gender, and race to ensure that results were representative of the U.S. population. Of those 4,700 respondents, 2,980 (59.6 percent) ate seafood (including shellfish, eels, or squid) in the last month (Table 10-15). The number of servings per month were categorized in ranges of 1-2, 3-5, 6-10, 11-19, and 20+ servings per month (Table 10-16). The highest percentage (35 percent) of respondent population had an intake of 3-5 servings per month. Most (92 percent) of the respondents purchased the seafood they ate (Table 10-17).

Intake data were not provided in the survey. However, intake of fish can be estimated using the information on the number of servings of fish eaten from this study and serving size data from other studies. The recommended mean value in this handbook for fish serving size is 129 g/serving (Table 10-8). Using this mean value for serving size and assuming that the average



individual eats 3-5 servings per month, the amount of seafood eaten per month would range from 387 to 645 grams/month or 12.9 to 21.5 g/day for the highest percentage of the population. These values are within the range of mean intake values for total fish (20.1 g/day) calculated in the U.S. EPA analysis of the USDA CSFII data. It should be noted that an all inclusive description for seafood was not presented in Tsang and Klepeis (1996). It is not known if processed or canned seafood and seafood mixtures are included in the seafood category.

The advantages of NHAPS is that the data were collected for a large number of individuals and are representative of the U.S. general population. However, evaluation of seafood intake was not the primary purpose of the study and the data do not reflect the actual amount of seafood that was eaten. However, using the assumption described above, the estimated seafood intake from this study are comparable to those observed in the EPA CSFII analysis.

#### **10.4. KEY RECREATIONAL (MARINE FISH STUDIES)**

*National Marine Fisheries Service (1986a, b, c; 1993)* - The National Marine Fisheries Service (NMFS) conducts systematic surveys, on a continuing basis, of marine recreational fishing. These surveys are designed to estimate the size of the recreational marine finfish catch by location, species and fishing mode. In addition, the surveys provide estimates for the total number of participants in marine recreational finfishing and the total number of fishing trips. The surveys are not designed to estimate individual consumption of fish from marine recreational sources, primarily because they do not attempt to estimate the number of individuals consuming the recreational catch. Intake rates for marine recreational anglers can be estimated, however, by employing assumptions derived from other data sources about the number of consumers.

The NMFS surveys involve two components, telephone surveys and direct interviewing of fishermen in the field. The telephone survey randomly samples residents of coastal regions, defined generally as counties within 25 miles of the nearest seacoast, and inquires about participation in marine recreational fishing in the resident's home state in the past year, and more specifically, in the past two months. This component of the survey is used to estimate, for each coastal state, the total number of coastal region residents who participate

in marine recreational fishing (for finfish) within the state, as well as the total number of (within state) fishing trips these residents take. To estimate the total number of participants and fishing trips in the state, by coastal residents and others, a ratio approach, based on the field interview data, was used. Thus, if the field survey data found that there was a 4:1 ratio of fishing trips taken by coastal residents as compared to trips taken by non-coastal and out of state residents, then an additional 25 percent would be added to the number of trips taken by coastal residents to generate an estimate of the total number of within state trips.

The field intercept survey is essentially a creel type survey. The survey utilizes a national site register which details marine fishing locations in each state. Sites for field interviews are chosen in proportion to fishing frequency at the site. Anglers fishing on shore, private boat, and charter/party boat modes who had completed their fishing were interviewed. The field survey included questions about frequency of fishing, area of fishing, age, and place of residence. The fish catch was classified by the interviewer as either type A, type B1 or type B2 catch. The type A catch denoted fish that were taken whole from the fishing site and were available for inspection. The type B1 and B2 catch were not available for inspection; the former consisted of fish used as bait, filleted, or discarded dead while the latter was fish released alive. The type A catch was identified by species and weighed, with the weight reflecting total fish weight, including inedible parts. The type B1 catch was not weighed, but weights were estimated using the average weight derived from the type A catch for the given species, state, fishing mode and season of the year. For both the A and B1 catch, the intended disposition of the catch (e.g., plan to eat, plan to throw away, etc.) was ascertained.

EPA obtained the raw data tapes from NMFS in order to generate intake distributions and other specialized analyses. Fish intake distributions were generated using the field survey tapes. Weights proportional to the inverse of the angler's reported fishing frequency were employed to correct for the unequal probabilities of sampling; this was the same approach used by NMFS in deriving their estimates. Note that in the field survey, anglers were interviewed regardless of past interviewing experience; thus, the use of inverse fishing frequency as weights was justified (see Section 10.1).

For each angler interviewed in the field survey, the yearly amount of fish caught that was intended to be eaten



---

**Chapter 10 - Intake of Fish and Shellfish**

---

by the angler and his/her family or friends was estimated by EPA as follows:

$$Y = [(wt\ of\ A\ catch) * I_A + (wt\ of\ B1\ catch) * I_B] * [Fishing\ frequency] \quad (Eqn.\ 10-1)$$

where  $I_A$  ( $I_B$ ) are indicator variables equal to 1 if the type A (B1) catch was intended to be eaten and equal to 0 otherwise. To convert  $Y$  to a daily fish intake rate by the angler, it was necessary to convert amount of fish caught to edible amount of fish, divide by the number of intended consumers, and convert from yearly to daily rate. Although theoretically possible, EPA chose not to use species specific edible fractions to convert overall weight to edible fish weight since edible fraction estimates were not readily available for many marine species. Instead, an average value of 0.5 was employed. For the number of intended consumers, EPA used an average value of 2.5 which was an average derived from the results of several studies of recreational fish consumption (Chemrisk, 1991; Puffer et al., 1981; West et al., 1989). Thus, the average daily intake rate (ADI) for each angler was calculated as

$$ADI = Y * (0.5) / [2.5 * 365] \quad (Eqn.\ 10-2)$$

Note that ADI will be 0 for those anglers who either did not intend to eat their catch or who did not catch any fish. The distribution of ADI among anglers was calculated by region and coastal status (i.e., coastal versus non-coastal counties). A mean ADI for the overall population of a given area was calculated as follows: first the estimated number of anglers in the area was multiplied by the average number of intended fish consumers (2.5) to get a total number of recreational marine finfish consumers. This number was then multiplied by the mean ADI among anglers to get the total recreational marine finfish consumption in the area. Finally, the mean ADI in the population was calculated by dividing total fish consumption by the total population in the area.

The results presented below are based on the results of the 1993 survey. Samples sizes were 200,000 for the telephone survey and 120,000 for the field surveys. All coastal states in the continental U.S. were included in the survey except Texas and Washington.

Table 10-18 presents the estimated number of coastal, non-coastal, and out-of-state fishing participants by state and region of fishing. Florida had the greatest number of both Atlantic and Gulf participants. The total

number of coastal residents who participated in marine finfishing in their home state was 8 million; an additional 750,000 non-coastal residents participated in marine finfishing in their home state.

Table 10-19 presents the estimated total weight of the A and B1 catch by region and time of year. For each region, the greatest catches were during the six-month period from May through October. This period accounted for about 90 percent of the North and Mid-Atlantic catch, about 80 percent of the Northern California and Oregon catch, about 70 percent of the Southern Atlantic and Southern California catch and 62 percent of the Gulf catch. Note that in the North and Mid-Atlantic regions, field surveys were not done in January and February due to very low fishing activity. For all regions, over half the catch occurred within 3 miles of the shore or in inland waterways.

Table 10-20 presents the mean and 95th percentile of average daily intake of recreationally caught marine finfish among anglers by region. The mean ADI among all anglers was 5.6, 7.2, and 2.0 g/day for the Atlantic, Gulf, and Pacific regions, respectively. Also given is the per-capita ADI in the overall population (anglers and non-anglers) of the region and in the overall coastal population of the region. Table 10-21 gives the distribution of the catch by species for the Atlantic and Gulf regions and Table 10-22 for Pacific regions.

The NMFS surveys provide a large, up-to-date, and geographically representative sample of marine angler activity in the U.S. The major limitation of this data base in terms of estimating fish intake is the lack of information regarding the intended number of consumers of each angler's catch. In this analysis, it was assumed that every angler's catch was consumed by the same number (2.5) of people; this number was derived from averaging the results of other studies. This assumption introduces a relatively low level of uncertainty in the estimated mean intake rates among anglers, but a somewhat higher level of uncertainty in the estimated intake distributions. It should be noted that under the above assumption, the distributions shown here pertain not only to the population of anglers, but also to the entire population of recreational fish consumers, which is 2.5 times the number of anglers. If the number of consumers was changed, to, for instance, 2.0, then the distribution would be increased by a factor of 1.25 (2.5/2.0), but the estimated population of recreational fish consumers to which the distribution would apply would decrease by a factor of 0.8 (2.0/2.5). Note that the mean



intake rate of marine finfish in the overall population is independent of the assumption of number of intended fish consumers.

Another uncertainty involves the use of 0.5 as an (average) edible fraction. This figure is somewhat conservative (i.e., the true average edible fraction is probably lower); thus, the intake rates calculated here may be biased upward somewhat.

It should be noted again that the recreational fish intake distributions given refer only to marine finfish. In addition, the intake rates calculated are based only on the catch of anglers in their home state. Marine fishing performed out-of-state would not be included in these distributions. Therefore, these distributions give an estimate of consumption of locally caught fish.

10.5. RELEVANT RECREATIONAL MARINE STUDIES

Puffer et al. (1981) - Intake Rates of Potentially Hazardous Marine Fish Caught in the Metropolitan Los Angeles Area - Puffer et al. (1981) conducted a creel survey with sport fishermen in the Los Angeles area in 1980. The survey was conducted at 12 sites in the harbor and coastal areas to evaluate intake rates of potentially hazardous marine fish and shellfish by local, non-professional fishermen. It was conducted for the full 1980 calendar year, although inclement weather in January, February, and March limited the interview days. Each site was surveyed an average of three times per month, on different days, and at a different time of the day. The survey questionnaire was designed to collect information on demographic characteristics, fishing patterns, species, number of fish caught, and fish consumption patterns. Scales were used to obtain fish weights. Interviews were conducted only with anglers who had caught fish, and the anglers were interviewed only once during the entire survey period.

Puffer et al. (1981) estimated daily consumption rates (grams/day) for each angler using the following equation:

$(K \times N \times W \times F) / [E \times 365]$ <p>where:</p> <p>K = edible fraction of fish (0.25 to 0.5 depending on species);</p> <p>N = number of fish in catch;</p> <p>W = average weight of (grams) fish in catch;</p> <p>F = frequency of fishing/year; and</p> <p>E = number of fish eaters in family/living group.</p>	(Eqn. 10-3)
---	-------------

No explicit survey weights were used in analyzing this survey; thus, each respondent's data was given equal weight.

A total of 1,059 anglers were interviewed for the survey. The ethnic and age distribution of respondents is shown in Table 10-23; 88 percent of respondents were male. The median intake rate was higher for Oriental/Samoan anglers (median 70.6 g/day) than for other ethnic groups and higher for those ages over 65 years (median 113.0 g/day) than for other age groups. Puffer et al. (1981) found similar median intake rates for seasons; 36.3 g/day for November through March and 37.7 g/day for April through October. Puffer et al. (1981) also evaluated fish preparation methods; these data are presented in Appendix 10B. The cumulative distribution of recreational fish (finfish and shellfish) consumption by survey respondents is presented in Table 10-24; this distribution was calculated only for those fishermen who indicated they eat the fish they catch. The median fish consumption rate was 37 g/day and the 90th percentile rate was 225 g/day (Puffer et al., 1981). A description of catch patterns for primary fish species kept is presented in Table 10-25.

As mentioned in the Background to this Chapter, intake distributions derived from analyses of creel surveys which did not employ weights reflective of sampling probabilities will overestimate the target population intake distribution and will, in fact, be more reflective of the "resource utilization distribution". Therefore, the reported median level of 37.3 g/day does not reflect the fact that 50 percent of the target population has intake above this level; instead 50 percent of recreational fish consumption is by individuals consuming at or above 37.3 g/day. In order to generate an intake distribution reflective of that in the target population, weights inversely proportional to sampling probability need to be employed. Price et al. (1994) made this attempt with the Puffer et al. (1981) survey data, using inverse fishing frequencies as the sampling weights. Price et al. (1994) was unable to get the raw data for this survey, but using frequency tables and the average level of fish consumption per fishing trip provided in Puffer et al. (1981), generated an approximate revised intake distribution. This distribution was dramatically lower than that obtained by Puffer et al. (1981); the median was estimated at 2.9 g/day (compared with 37.3 from Puffer et al., 1981) and the 90th percentile at 35 g/day (compared to 225 g/day from Puffer et al., 1981).



There are several limitations to the interpretation of the percentiles presented by both Puffer et al. (1981) and Price et al. (1994). As described in Appendix 10A, the interpretation of percentiles reported from creel surveys in terms of percentiles of the “resource utilization distribution” is approximate and depends on several assumptions. One of these assumptions is that sampling probability is proportional to inverse fishing frequency. In this survey, where interviewers revisited sites numerous times and anglers were not interviewed more than once, this assumption is not valid, though it is likely that the sampling probability is still highly dependant on fishing frequency so that the assumption does hold in an approximate sense. The validity of this assumption also impacts the interpretation of percentiles reported by Price et al. (1994) since inverse frequency was used as sampling weights. It is likely that the value (2.9 g/day) of Price et al. (1994) underestimates somewhat the median intake in the target population, but is much closer to the actual value than the Puffer et al. (1981) estimate of 37.3 g/day. Similar statements would apply about the 90th percentile. Similarly, the 37.3 g/day median value, if interpreted as the 50th percentile of the “resource utilization distribution”, is also somewhat of an underestimate.

It should be noted again that the fish intake distribution generated by Puffer et al. (1981) (and by Price et al., 1994) was based only on fishermen who caught fish and ate the fish they caught. If all anglers were included, intake estimates would be somewhat lower. In contrast, the survey assumed that the number of fish caught at the time of the interview was all that would be caught that day. If it were possible to interview fishermen at the conclusion of their fishing day, intake estimates could be potentially higher. An additional factor potentially affecting intake rates is that fishing quarantines were imposed in early spring due to heavy sewage overflow (Puffer et al., 1981).

*Pierce et al. (1981) - Commencement Bay Seafood Consumption Study* - Pierce et al. (1981) performed a local creel survey to examine seafood consumption patterns and demographics of sport fishermen in Commencement Bay, Washington. The objectives of this survey included determining (1) seafood consumption habits and demographics of non-commercial anglers catching seafood; (2) the extent to which resident fish were used as food; and (3) the method of preparation of the fish to be consumed. Salmon were excluded from the survey since it was believed that they had little potential for contamination. The first half of this survey was

conducted from early July to mid-September, 1980 and the second half from mid-September through most of November. During the summer months, interviewers visited each of 4 sub-areas of Commencement Bay on five mornings and five evenings; in the fall the areas were sampled 4 complete survey days. Interviews were conducted only with persons who had caught fish. The anglers were interviewed only once during the survey period. Data were recorded for species, wet weight, size of the living group (family, place of residence, fishing frequency, planned uses of the fish, age, sex, and race (Pierce et al., 1981). The analysis of Pierce et al. (1981) did not employ explicit sampling weights (i.e., all weights were set to 1).

There were 304 interviews in the summer and 204 in the fall. About 60 percent of anglers were white, 20 percent black, 19 percent Oriental and the rest Hispanic or Native American. Table 10-26 gives the distribution of fishing frequency calculated by Pierce et al. (1981); for both the summer and fall, more than half of the fishermen caught and consumed fish weekly. The dominant (by weight) species caught were Pacific Hake and Walleye Pollock. Pierce et al. (1981) did not present a distribution of fish intake or a mean fish intake rate.

The U.S. EPA (1989a) used the Pierce et al. (1981) fishing frequency distribution and an estimate of the average amount of fish consumed per angling trip to create an approximate intake distribution for the Pierce et al. (1981) survey. The estimate of the amount of fish consumed per angling trip (380 g/person-trip) was based on data on mean fish catch weight and mean number of consumers reported in Pierce et al. (1981) and on an edible fraction of 0.5. U.S. EPA (1989a) reported a median intake rate of 23 g/day.

Price et al. (1994) obtained the raw data from this survey and performed a re-analysis using sampling weights proportional to inverse fishing frequency. The rationale for these weights is explained in Section 10.1 and in the discussion above of the Puffer et al. (1981) study. In the re-analysis, Price et al. (1994) found a median intake rate of 1.0 g/day and a 90th percentile rate of 13 g/day. The distribution of fishing frequency generated by Price et al. (1994) is shown in Table 10-27. Note that when equal weights were used, Price et al. (1994) found a median rate of 19 g/day, which was close to the approximate U.S. EPA (1989a) value reported above of 23 g/day.

The same limitations apply to interpreting the results presented here to those presented above in the





discussion of Puffer et al. (1981). The median intake rate found by Price et al. (1994) (using inverse frequency weights) is more reflective of median intake in the target population than is the value of 19 g/day (or 23 g/day); the latter value reflects more the 50th percentile of the resource utilization distribution, (i.e., that anglers with intakes above 19 g/day consume 50 percent of the recreational fish catch). Similarly, the fishing frequency distribution generated by Price et al. (1994) is more reflective of the fishing frequency distribution in the target population than is the distribution presented in Pierce et al. (1981). Note the target population is those anglers who fished at Commencement Bay during the time period of the survey.

As with the Puffer et al. (1981) data, these values (1.0 g/day and 19 g/day) are both probably underestimates since the sampling probabilities are less than proportional to fishing frequency; thus, the true target population median is probably somewhat above 1.0 g/day and the true 50th percentile of the resource utilization distribution is probably somewhat higher than 19 g/day. The data from this survey provide an indication of consumption patterns for the time period around 1980 in the Commencement Bay area. However, the data may not reflect current consumption patterns because fishing advisories were instituted due to local contamination.

*U.S. DHHS (1995) - Health Study to Assess the Human Health Effects of Mercury Exposure to Fish Consumed from the Everglades* - A health study was conducted in two phases in the Everglades, Florida for the U.S. Department of Health and Human Services (U.S. DHHS, 1995). The objectives of the first phase were to: (a) describe the human populations at risk for mercury exposure through their consumption of fish and other contaminated animals from the Everglades and (b) evaluate the extent of mercury exposure in those persons consuming contaminated food and their compliance with the voluntary health advisory. The second phase of the study involved neurologic testing of all study participants who had total mercury levels in hair greater than 7.5  $\mu\text{g/g}$ . Study participants were identified by using special targeted screenings, mailings to residents, postings and multi-media advertisements of the study throughout the Everglades region, and direct discussions with people fishing along the canals and waterways in the contaminated areas. The contaminated areas were identified by the interviewers and long-term Everglade residents. Of a total of 1,794 individuals sampled, 405 individuals were eligible to participate in the study

because they had consumed fish or wildlife from the Everglades at least once per month in the last 3 months of the study period. The majority of the eligible participants (> 93 percent) were either subsistence fishermen, Everglade residents, or both. Of the total eligible participants, 55 individuals refused to participate in the survey. Useable data were obtained from 330 respondents ranging in age from 10-81 years of age (mean age 39 years  $\pm$  18.8) (U.S. DHHS, 1995). Respondents were administered a three page questionnaire from which demographic information, fishing and eating habits, and other variables were obtained (U.S. DHHS, 1995).

Table 10-28 shows the ranges, means, and standard deviations of selected characteristics by subgroups of the survey population. Sixty-two percent of the respondents were male with a slight preponderance of black individuals (43 percent white, 46 percent black non-Hispanic, and 11 percent Hispanic) (Table 10-28). Most of the respondents reported earning an annual income of \$15,000 or less per family before taxes (U.S. DHHS, 1995). The mean number of years fished along the canals by the respondents was 15.8 years with a standard deviation of 15.8. The mean number of times per week fish consumers reported eating fish over the last 6 months and last month of the survey period was 1.8 and 1.5 per week with a standard deviation of 2.5 and 1.4, respectively (Table 10-28). Table 10-28 also indicates that 71 percent of the respondents reported knowing about the mercury health advisories. Of those who were aware, 26 percent reported that they had lowered their consumption of fish caught in the Everglades while the rest (74 percent) reported no change in consumption patterns (U.S. DHHS, 1995).

A limitation of this study is that fish intake rates (g/day) were not reported. Another limitation is that the survey was site limited, and, therefore, not representative of the U.S. population. An advantage of this study is that it is one of the few studies targeting subsistence fishermen.

#### **10.6. KEY FRESHWATER RECREATIONAL STUDIES**

*West et al. (1989) - Michigan Sport Anglers Fish Consumption Survey, 1989* - surveyed a stratified random sample of Michigan residents with fishing licences. The sample was divided into 18 cohorts, with one cohort receiving a mail questionnaire each week between January and May 1989. The survey included both a short term recall component recording respondents' fish intake over



---

**Chapter 10 - Intake of Fish and Shellfish**

---

a seven day period and a usual frequency component. For the short-term component, respondents were asked to identify all household members and list all fish meals consumed by each household member during the past seven days. The source of the fish for each meal was requested (self-caught, gift, market, or restaurant). Respondents were asked to categorize serving size by comparison with pictures of 8 oz. fish portions; serving sizes could be designated as either “about the same size”, “less”, or “more” than the 8 oz. picture. Data on fish species, locations of self-caught fish and methods of preparation and cooking were also obtained.

The usual frequency component of the survey asked about the frequency of fish meals during each of the four seasons and requested respondents to give the overall percentage of household fish meals that come from recreational sources. A sample of 2,600 individuals were selected from state records to receive survey questionnaires. A total of 2,334 survey questionnaires were deliverable and 1,104 were completed and returned, giving a response rate of 47.3 percent among individuals receiving questionnaires.

In the analysis of the survey data by West et al. (1989), the authors did not attempt to generate the distribution of recreationally caught fish intake in the survey population. EPA obtained the raw data of this survey for the purpose of generating fish intake distributions and other specialized analyses.

As described elsewhere in this handbook, percentiles of the distribution of average daily intake reflective of long-term consumption patterns can not in general be estimated using short-term (e.g., one week) data. Such data can be used to estimate mean average daily intake rates (reflective of short or long term consumption); in addition, short term data can serve to validate estimates of usual intake based on longer recall.

EPA first analyzed the short term data with the intent of estimating mean fish intake rates. In order to compare these results with those based on usual intake, only respondents with information on both short term and usual intake were included in this analysis. For the analysis of the short term data, EPA modified the serving size weights used by West et al. (1989), which were 5, 8 and 10 oz., respectively, for portions that were less, about the same, and more than the 8 oz. picture. EPA examined the percentiles of the distribution of fish meal sizes reported in Pao et al. (1982) derived from the 1977-1978 USDA National Food Consumption Survey and observed that a lognormal distribution provided a good visual fit to

the percentile data. Using this lognormal distribution, the mean values for serving sizes greater than 8 oz. and for serving sizes at least 10 percent greater than 8 oz. were determined. In both cases a serving size of 12 oz. was consistent with the Pao et al. (1982) distribution. The weights used in the EPA analysis then were 5, 8, and 12 oz. for fish meals described as less, about the same, and more than the 8 oz. picture, respectively. It should be noted that the mean serving size from Pao et al. (1982) was about 5 oz., well below the value of 8 oz. most commonly reported by respondents in the West et al. (1989) survey.

Table 10-29 displays the mean number of total and recreational fish meals for each household member based on the seven day recall data. Also shown are mean fish intake rates derived by applying the weights described above to each fish meal. Intake was calculated on both a grams/day and grams/kg body weight/day basis. This analysis was restricted to individuals who eat fish and who reside in households reporting some recreational fish consumption during the previous year. About 75 percent of survey respondents (i.e., licensed anglers) and about 84 percent of respondents who fished in the prior year reported some household recreational fish consumption.

The EPA analysis next attempted to use the short term data to validate the usual intake data. West et al. (1989) asked the main respondent in each household to provide estimates of their usual frequency of fishing and eating fish, by season, during the previous year. The survey provides a series of frequency categories for each season and the respondent was asked to check the appropriate range. The ranges used for all questions were: almost daily, 2-4 times a week, once a week, 2-3 times a month, once a month, less often, none, and don't know. For quantitative analysis of the data it is necessary to convert this categorical information into numerical frequency values. As some of the ranges are relatively broad, the choice of conversion values can have some effect on intake estimates. In order to obtain optimal values, the usual fish eating frequency reported by respondents for the season during which the questionnaire was completed was compared to the number of fish meals reportedly consumed by respondents over the seven day short-term recall period. The results of these comparisons are displayed in Table 10-30; it shows that, on average, there is general agreement between estimates made using one year recall and estimates based on seven day recall. The average number of meals (1.96/week) was at the bottom of the range for the most frequent consumption



group with data (2-4 meals/week). In contrast, for the lower usual frequency categories, the average number of meals was at the top, or exceeded the top of category range. This suggests some tendency for relatively infrequent fish eaters to underestimate their usual frequency of fish consumption. The last column of the table shows the estimated fish eating frequency per week that was selected for use in making quantitative estimates of usual fish intake. These values were guided by the values in the second column, except that frequency values that were inconsistent with the ranges provided to respondents in the survey were avoided.

Using the four seasonal fish eating frequencies provided by respondents and the above conversions for reported intake frequency, EPA estimated the average number of fish meals per week for each respondent. This estimate, as well as the analysis above, pertain to the total number of fish meals eaten (in Michigan) regardless of the source of the fish. Respondents were not asked to provide a seasonal breakdown for eating frequency of recreationally caught fish; rather, they provided an overall estimate for the past year of the percent of fish they ate that was obtained from different sources. EPA estimated the annual frequency of recreationally caught fish meals by multiplying the estimated total number of fish meals by the reported percent of fish meals obtained from recreational sources; recreational sources were defined as either self caught or a gift from family or friends.

The usual intake component of the survey did not include questions about the usual portion size for fish meals. In order to estimate usual fish intake, a portion size of 8 oz. was applied (the majority of respondents reported this meal size in the 7 day recall data). Individual body weight data were used to estimate intake on a g/kg-day basis. The fish intake distribution estimated by EPA is displayed in Table 10-31.

The distribution shown in Table 10-31 is based on respondents who consumed recreational caught fish. As mentioned above, these represent 75 percent of all respondents and 84 percent of respondents who reported having fished in the prior year. Among this latter population, the mean recreational fish intake rate is  $14.4 \times 0.84 = 12.1$  g/day; the value of 38.7 g/day (95th percentile among consumers) corresponds to the 95.8th percentile of the fish intake distribution in this (fishing) population.

The advantages of this data set and analysis are that the survey was relatively large and contained both short-

term and usual intake data. The presence of short term data allowed validation of the usual intake data which was based on long term recall; thus, some of the problems associated with surveys relying on long term recall are mitigated here.

The response rate of this survey, 47 percent, was relatively low. In addition, the usual fish intake distribution generated here employed a constant fish meal size, 8 oz.. Although use of this value as an average meal size was validated by the short-term recall results, the use of a constant meal size, even if correct on average, may seriously reduce the variation in the estimated fish intake distribution.

This study was conducted in the winter and spring months of 1988. This period does not include the summer months when peak fishing activity can be anticipated, leading to the possibility that intake results based on the 7 day recall data may understate individuals' usual (annual average) fish consumption. A second survey by West et al. (1993) gathered diary data on fish intake for respondents spaced over a full year. However, this later survey did not include questions about usual fish intake and has not been reanalyzed here. The mean recreational fish intake rates derived from the short term and usual components were quite similar, however, 14.0 versus 14.4 g/day.

*Chemrisk (1991) - Consumption of Freshwater Fish by Maine Anglers* - Chemrisk conducted a study to characterize the rates of freshwater fish consumption among Maine residents (Chemrisk, 1991; Ebert et al., 1993). Since the only dietary source of local freshwater fish is recreational fish, the anglers in Maine were chosen as the survey population. The survey was designed to gather information on the consumption of fish caught by anglers from flowing (rivers and streams) and standing (lakes and ponds) water bodies. Respondents were asked to recall the frequency of fishing trips during the 1989-1990 ice-fishing season and the 1990 open water season, the number of fish species caught during both seasons, and estimate the number of fish consumed from 15 fish species. The respondents were also asked to describe the number, species, and average length of each sport-caught fish consumed that had been gifts from other members of their households or other household. The weight of fish consumed by anglers was calculated by first multiplying the estimated weight of the fish by the edible fraction, and then dividing this product by the number of intended consumers. Species specific regression equations were utilized to estimate weight from the reported fish length.



---

**Chapter 10 - Intake of Fish and Shellfish**

---

The edible fractions used were 0.4 for salmon, 0.78 for Atlantic smelt, and 0.3 for all other species (Ebert et al., 1993).

A total of 2,500 prospective survey participants were randomly selected from a list of anglers licensed in Maine. The surveys were mailed in during October, 1990. Since this was before the end of the open fishing season, respondents were also asked to predict how many more open water fishing trips they would undertake in 1990.

Chemrisk (1991) and Ebert et al. (1993) calculated distributions of freshwater fish intake for two populations, "all anglers" and "consuming anglers". All anglers were defined as licensed anglers who fished during either the 1989-1990 ice-fishing season or the 1990 open-water season (consumers and non-consumers) and licensed anglers who did not fish but consumed freshwater fish caught in Maine during these seasons. "Consuming anglers" were defined as those anglers who consumed freshwater fish obtained from Maine sources during the 1989-1990 ice fishing or 1990 open water fishing season. In addition, the distribution of fish intake from rivers and streams was also calculated for two populations, those fishing on rivers and streams ("river anglers") and those consuming fish from rivers and streams ("consuming river anglers").

A total of 1,612 surveys were returned, giving a response rate of 64 percent; 1,369 (85 percent) of the 1,612 respondents were included in the "all angler" population and 1,053 (65 percent) were included in the "consuming angler" population. Freshwater fish intake distributions for these populations are presented in Table 10-32. The mean and 95th percentile was 5.0 g/day and 21.0 g/day, respectively, for "all anglers," and 6.4 g/day and 26.0 g/day, respectively, for "consuming anglers." Table 10-32 also presents intake distributions for fish caught from rivers and streams. Among "river anglers" the mean and 95th percentiles were 1.9 g/day and 6.2 g/day, respectively, while among "consuming river anglers" the mean was 3.7 g/day and the 95th percentile was 12.0 g/day. Table 10-33 presents fish intake distributions by ethnic group for consuming anglers. The highest mean intake rates reported are for Native Americans (10 g/day) and French Canadians (7.4 g/day). Because there was a low number of respondents for Hispanics, Asian/Pacific Islanders, and African Americans, intake rates within these subgroups were not calculated (Chemrisk, 1991).

The consumption, by species, of freshwater fish caught is presented in Table 10-34. The largest specie consumption was salmon from ice fishing (~292,000

grams); white perch (380,000 grams) for lakes and ponds; and Brooktrout (420,000 grams) for rivers and streams (Chemrisk, 1991).

EPA obtained the raw data tapes from the marine anglers survey and performed some specialized analyses. One analysis involved examining the percentiles of the "resource utilization distribution" (this distribution was defined in Section 10.1). The 50th, or more generally the pth percentile of the resource utilization distribution, is defined as the consumption level such that p percent of the resource is consumed by individuals with consumptions below this level and 100-p percent by individuals with consumptions above this level. EPA found that 90 percent of recreational fish consumption was by individuals with intake rates above 3.1 g/day and 50 percent was by individuals with intakes above 20 g/day. Those above 3.1 g/day make up about 30 percent of the "all angler" population and those above 20 g/day make up about 5 percent of this population; thus, the top 5 percent of the angler population consumed 50 percent of the recreational fish catch.

EPA also performed an analysis of fish consumption among anglers and their families. This analysis was possible because the survey included questions on the number, sex, and age of each individual in the household and whether the individual consumed recreationally caught fish. The total population of licensed anglers in this survey and their household members was 4,872; the average household size for the 1,612 anglers in the survey was thus 3.0 persons. Fifty-six percent of the population was male and 30 percent was 18 or under.

A total of 55 percent of this population was reported to consume freshwater recreationally caught fish in the year of the survey. The sex and ethnic distribution of the consumers was similar to that of the overall population. The distribution of fish intake among the overall household population, or among consumers in the household, can be calculated under the assumption that recreationally caught fish was shared equally among all members of the household reporting consumption of such fish (note this assumption was used above to calculate intake rates for anglers). With this assumption, the mean intake rate among consumers was 5.9 g/day with a median of 1.8 g/day and a 95th percentile of 23.1 g/day; for the overall population the mean was 3.2 g/day and the 95th percentile was 14.1 g/day.

The results of this survey can be put into the context of the overall Maine population. The 1,612



anglers surveyed represent about 0.7 percent of the estimated 225,000 licensed anglers in Maine. It is reasonable to assume that licensed anglers and their families will have the highest exposure to recreationally caught freshwater fish. Thus, to estimate the number of persons in Maine with recreationally caught freshwater fish intake above, for instance, 6.5 g/day (the 80th percentile among household consumers in this survey), one can assume that virtually all persons came from the population of licensed anglers and their families. The number of persons above 6.5 g/day in the household survey population is calculated by taking 20 percent (i.e., 100 percent - 80 percent) of the consuming population in the survey; this number then is  $0.2 \times (0.55 \times 4872) = 536$ . Dividing this number by the sampling fraction of 0.007 (0.7 percent) gives about 77,000 persons above 6.5 g/day of recreational freshwater fish consumption statewide. The 1990 census showed the population of Maine to be 1.2 million people; thus the 77,000 persons above 6.5 g/day represent about 6 percent of the state's population.

Chemrisk (1991) reported that the fish consumption estimates obtained from the survey were conservative because of assumptions made in the analysis. The assumptions included: a 40 percent estimate as the edible portion of landlocked and Atlantic salmon; inclusion of the intended number of future fishing trips and an assumption that the average success and consumption rates for the individual angler during the trips already taken would continue through future trips. The data collected for this study were based on recall and self-reporting which may have resulted in a biased estimate. The social desirability of the sport and frequency of fishing are also bias contributing factors; successful anglers are among the highest consumers of freshwater fish (Chemrisk, 1991). Over reporting appears to be correlated with skill level and the importance of the activity to the individual; it is likely that the higher consumption rates may be substantially overstated (Chemrisk, 1991). Additionally, fish advisories are in place in these areas and may affect the rate of fish consumption among anglers. The survey results showed that in 1990, 23 percent of all anglers consumed no freshwater fish, and 55 percent of the river anglers ate no freshwater fish. An advantage of this study is that it presents area-specific consumption patterns and the sample size is rather large.

*West et al. (1993) - Michigan Sport Anglers Fish Consumption Study, 1991-1992* - This survey, financed by the Michigan Great Lakes Protection Fund, was a follow-

up to the earlier 1989 Michigan survey described previously. The major purpose of 1991-1992 survey was to provide short-term recall data of recreational fish consumption over a full year period; the 1989 survey, in contrast, was conducted over only a half year period (West et al., 1993).

This survey was similar in design to the 1989 Michigan survey. A sample of 7,000 persons with Michigan fishing licenses was drawn and surveys were mailed in 2-week cohorts over the period January, 1991 to January, 1992. Respondents were asked to report detailed fish consumption patterns during the preceding seven days, as well as demographic information; they were also asked if they currently eat fish. Enclosed with the survey were pictures of about a half pound of fish. Respondents were asked to indicate whether reported consumption at each meal was more, less or about the same as the picture. Based on responses to this question, respondents were assumed to have consumed 10, 5 or 8 ounces of fish, respectively.

A total of 2,681 surveys were returned. West et al. (1993) calculated a response rate for the survey of 46.8 percent; this was derived by removing from the sample those respondents who could not be located or who did not reside in Michigan for at least six months.

Of these 2,681 respondents, 2,475 (93 percent) reported that they currently eat fish; all subsequent analyses were restricted to the current fish eaters. The mean fish consumption rates were found to be 16.7 g/day for sport fish and 26.5 g/day for total fish (West et al., 1993). Table 10-35 shows mean sport-fish consumption rates by demographic categories. Rates were higher among minorities, people with low income, and people residing in smaller communities. Consumption rates in g/day were also higher in males than in females; however, this difference would likely disappear if rates were computed on a g/kg-day basis.

West et al. (1993) estimated the 80th percentile of the survey fish consumption distribution. More extensive percentile calculations were performed by U.S. EPA (1995) using the raw data from the West et al. (1993) survey and calculated 50th, 90th, and 95th percentiles. However, since this survey only measured fish consumption over a short (one week) interval, the resulting distribution will not be indicative of the long-term fish consumption distribution and the upper percentiles reported from the EPA analysis will likely considerably overestimate the corresponding long term percentiles. The overall 95th percentile calculated by



---

**Chapter 10 - Intake of Fish and Shellfish**

---

U.S. EPA (1995) was 77.9; this is about double the 95th percentile estimated using year long consumption data from the 1989 Michigan survey.

The limitations of this survey are the relatively low response rate and the fact that only three categories were used to assign fish portion size. The main study strengths were its relatively large size and its reliance on short-term recall.

Connelly et al. (1996) - *Sportfish Consumption Patterns of Lake Ontario Anglers and the Relationship to Health Advisories, 1992* - The objectives of this study were to provide accurate estimates of fish consumption (overall and sport caught) among Lake Ontario anglers and to evaluate the effect of Lake Ontario health advisory recommendations (Connelly et al., 1996). To target Lake Ontario anglers, a sample of 2,500 names was randomly drawn from 1990-1991 New York fishing license records for licenses purchased in six counties bordering Lake Ontario. Participation in the study was solicited by mail with potential participants encouraged to enroll in the study even if they fished infrequently or consumed little or no sport caught fish. The survey design involved three survey techniques including a mail questionnaire asking for 12 month recall of 1991 fishing trips and fish consumption, self-recording information in a diary for 1992 fishing trips and fish consumption, periodic telephone interviews to gather information recorded in the diary and a final telephone interview to determine awareness of health advisories (Connelly et al., 1996).

Participants were instructed to record in the diary the species of fish eaten, meal size, method by which fish was acquired (sport-caught or other), fish preparation and cooking techniques used and the number of household members eating the meal. Fish meals were defined as finfish only. Meal size was estimated by participants by comparing their meal size to pictures of 8 oz. fish steaks and fillets on dinner plates. An 8 oz. size was assumed unless participants noted their meal size was smaller than 8 oz., in which case a 4 oz. size was assumed, or they noted it was larger than 8 oz., in which case a 12 oz. size was assumed. Participants were also asked to record information on fishing trips to Lake Ontario and species and length of any fish caught.

From the initial sample of 2,500 license buyers, 1,993 (80 percent) were reachable by phone or mail and 1,410 of these were eligible for the study, in that they intended to fish Lake Ontario in 1992. A total of 1,202 of these 1,410, or 85 percent, agreed to participate in the study. Of the 1,202 participants, 853 either returned the

diary or provided diary information by telephone. Due to changes in health advisories for Lake Ontario which resulted in less Lake Ontario fishing in 1992, only 43 percent, or 366 of these 853 persons indicated that they fished Lake Ontario during 1992. The study analyses summarized below concerning fish consumption and Lake Ontario fishing participation are based on these 366 persons.

Anglers who fished Lake Ontario reported an average of 30.3 (S.E. = 2.3) fish meals per person from all sources in 1992; of these meals 28 percent were sport caught (Connelly et al., 1996). Less than 1 percent ate no fish for the year and 16 percent ate no sport caught fish. The mean fish intake rate from all sources was 17.9 g/day and from sport caught sources was 4.9 g/day. Table 10-36 gives the distribution of fish intake rates from all sources and from sport caught fish. The median rates were 14.1 g/day for all sources and 2.2 g/day for sport caught; the 95th percentiles were 42.3 g/day and 17.9 g/day for all sources and sport caught, respectively. As seen in Table 10-37, statistically significant differences in intake rates were seen across age and residence groups, with residents of large cities and younger people having lower intake rates on average.

The main advantage of this study is the diary format. This format provides more accurate information on fishing participation and fish consumption, than studies based on 1 year recall (Ebert et al., 1993). However, a considerable portion of diary respondents participated in the study for only a portion of the year and some errors may have been generated in extrapolating these respondents' results to the entire year (Connelly et al., 1996). In addition, the response rate for this study was relatively low, 853 of 1,410 eligible respondents, or 60 percent, which may have engendered some non-response bias.

The presence of health advisories should be taken into account when evaluating the intake rates observed in this study. Nearly all respondents (>95 percent) were aware of the Lake Ontario health advisory. This advisory counseled to eat none of 9 fish species from Lake Ontario and to eat no more than one meal per month of another 4 species. In addition, New York State issues a general advisory to eat no more than 52 sport caught fish meals per year. Among participants who fished Lake Ontario in 1992, 32 percent said they would eat more fish if health advisories did not exist. A significant fraction of respondents did not totally adhere to the fish advisory; however, 36 percent of respondents, and 72 percent of



respondents reporting Lake Ontario fish consumption, ate at least one species of fish over the advisory limit. Interestingly, 90 percent of those violating the advisory reported that they believed they were eating within advisory limits.

#### 10.7. RELEVANT FRESHWATER RECREATIONAL STUDIES

*Fiore et al. (1989) - Sport Fish Consumption and Body Burden Levels of Chlorinated Hydrocarbons: A Study of Wisconsin Anglers.* This survey, reported by Fiore et al. (1989), was conducted to assess sociodemographic factors and sport fishing habits of anglers, to evaluate anglers' comprehension of and compliance with the Wisconsin Fish Consumption Advisory, to measure body burden levels of PCBs and DDE through analysis of blood serum samples and to examine the relationship between body burden levels and consumption of sport-caught fish. The survey targeted all Wisconsin residents who had purchased fishing or sporting licenses in 1984 in any of 10 pre-selected study counties. These counties were chosen in part based on their proximity to water bodies identified in Wisconsin fish advisories. A total of 1,600 anglers were sent survey questionnaires during the summer of 1985.

The survey questionnaire included questions about fishing history, locations fished, species targeted, kilograms caught for consumption, overall fish consumption (including commercially caught) and knowledge of fish advisories. The recall period was one year.

A total of 801 surveys were returned (50 percent response rate). Of these, 601 (75 percent) were from males and 200 from females; the mean age was 37 years. Fiore et al. (1989) reported that the mean number of fish meals for 1984 for all respondents was 18 for sport-caught meals and 24 for non-sport caught meals. Fiore et al. (1989) assumed that each fish meal consisted of 8 ounces (227 grams) of fish to generate means and percentiles of fish intake. The reported per-capita intake rate of sport-caught fish was 11.2 g/day; among consumers, who comprised 91 percent of all respondents, the mean sport-caught fish intake rate was 12.3 g/day and the 95th percentile was 37.3 g/day. The mean daily fish intake from all sources (both sport caught and commercial) was 26.1 g/day with a 95th percentile of 63.4 g/day. The 95th percentile of 37.3 g/day of sport caught fish represents 60 fish meals per year; 63.4 g/day (the 95th percentile of total fish intake) represents 102 fish meals per year.

Fiore et al. (1989) assumed a (constant) meal size of 8 ounces (227 grams) of fish which may over-estimate average meal size. Pao et al. (1982), using data from the 1977-78 USDA NFCS, reported an average fish meal size of slightly less than 150 grams for adult males. EPA obtained the raw data from this study and calculated the distribution of the number of sport-caught fish meals and the distribution of fish intake rates (using 150 grams/meal); these distributions are presented in Table 10-38. With this average meal size, the per-capita estimate is 7.4 g/day.

This study is limited in its ability to accurately estimate intake rates because of the absence of data on weight of fish consumed. Another limitation of this study is that the results are based on one year recall, which may tend to over-estimate the number of fishing trips (Ebert et al., 1993). In addition, the response rate was rather low (50 percent).

*Connelly et al. (1992) - Effects of Health Advisory and Advisory Changes on Fishing Habits and Fish Consumption in New York Sport Fisheries - Connelly et al. (1992)* conducted a study to assess the awareness and knowledge of New York anglers about fishing advisories and contaminants found in fish and their fishing and fish consuming behaviors. The survey sample consisted of 2,000 anglers with New York State fishing licenses for the year beginning October 1, 1990 through September 30, 1991. A questionnaire was mailed to the survey sample in January, 1992. The questionnaire was designed to measure catch and consumption of fish, as well as methods of fish preparation and knowledge of and attitudes towards health advisories (Connelly et al., 1992). The survey adjusted response rate was 52.8 percent (1,030 questionnaires were completed and 51 were not deliverable).

The average and median number of fishing days per year were 27 and 15 days respectively (Connelly et al. 1992). The mean number of sport-caught fish meals was 11. About 25 percent of anglers reported that they did not consume sport-caught fish.

Connelly et al. (1992) found that 80 percent of anglers statewide did not eat listed species or ate them within advisory limits and followed the 1 sport-caught fish meal per week recommended maximum. The other 20 percent of anglers exceeded the advisory recommendations in some way; 15 percent ate listed species above the limit and 5 percent ate more than one sport caught meal per week.



---

**Chapter 10 - Intake of Fish and Shellfish**

---

Connelly et al. (1992) found that respondents eating more than one sport-caught meal per week were just as likely as those eating less than one meal per week to know the recommended level of sport-caught fish consumption, although less than 1/3 in each group knew the level. An estimated 85 percent of anglers were aware of the health advisory. Over 50 percent of respondents said that they made changes in their fishing or fish consumption behaviors in response to health advisories.

The advisory included a section on methods that can be used to reduce contaminant exposure. Respondents were asked what methods they used for fish cleaning and cooking. Summary results on preparation and cooking methods are presented in Section 10.9 and in Appendix 10B.

A limitation of this study with respect to estimating fish intake rates is that only the number of sport-caught meals was ascertained, not the weight of fish consumed. The fish meal data can be converted to an intake rate (g/day) by assuming a value for a fish meal such as that from Pao et al. (1982) (about 150 grams as the average amount of fish consumed per eating occasion for adult males - males comprised 88 percent of respondents in the current study).

Using 150 grams/meal the mean intake rate among the angler population would be 4.5 g/day; note that about 25 percent of this population reported no sport-caught fish consumption.

The major focus of this study was not on consumption, per se, but on the knowledge of and impact of fish health advisories; Connelly et al. (1992) provides important information on these issues.

*Hudson River Sloop Clearwater, Inc. (1993) - Hudson River Angler Survey* - Hudson River Sloop Clearwater, Inc. (1993) conducted a survey of adherence to fish consumption health advisories among Hudson River anglers. All fishing has been banned on the upper Hudson River where high levels of PCB contamination are well documented; while voluntary recreational fish consumption advisories have been issued for areas south of the Troy Dam (Hudson River Sloop Clearwater, Inc., 1993).

The survey consisted of direct interviews with 336 shore-based anglers between the months of June and November 1991, and April and July 1992. Socio-demographic characteristics of the respondents are presented in Table 10-39. The survey sites were selected based on observations of use by anglers, and legal accessibility. The selected sites included upper, mid-, and lower Hudson River sites located in both rural and urban

settings. The interviews were conducted on weekends and weekdays during morning, midday, and evening periods. The anglers were asked specific questions concerning: fishing and fish consumption habits; perceptions of presence of contaminants in fish; perceptions of risks associated with consumption of recreationally caught fish; and awareness of, attitude toward, and response to fish consumption advisories or fishing bans.

Approximately 92 percent of the survey respondents were male. The following statistics were provided by Hudson River Sloop Clearwater, Inc. (1993). The most common reason given for fishing was for recreation or enjoyment. Over 58 percent of those surveyed indicated that they eat their catch. Of those anglers who eat their catch, 48 percent reported being aware of advisories. Approximately 24 percent of those who said they currently do not eat their catch, have done so in the past. Anglers were more likely to eat their catch from the lower Hudson areas where health advisories, rather than fishing bans, have been issued. Approximately 94 percent of Hispanic Americans were likely to eat their catch, while 77 percent of African Americans and 47 percent of Caucasian Americans intended to eat their catch. Of those who eat their catch, 87 percent were likely to share their meal with others (including women of childbearing age, and children under the age of fifteen).

For subsistence anglers, more low-income than upper income anglers eat their catch (Hudson River Sloop Clearwater, Inc., 1993). Approximately 10 percent of the respondents stated that food was their primary reason for fishing; this group is more likely to be in the lowest per capita income group (Hudson River Sloop Clearwater, Inc., 1993).

The average frequency of fish consumption reported was just under one (0.9) meal over the previous week, and three meals over the previous month. Approximately 35 percent of all anglers who eat their catch exceeded the amounts recommended by the New York State health advisories. Less than half (48 percent) of all the anglers interviewed were aware of the State health advisories or fishing bans. Only 42 percent of those anglers aware of the advisories have changed their fishing habits as a result.

The advantages of this study include: in-person interviews with 95 percent of all anglers approached; field-tested questions designed to minimize interviewer bias; and candid responses concerning consumption of fish from contaminated waters. The limitations of this





study are that specific intake amounts are not indicated, and that only shore-based anglers were interviewed.

#### **10.8. NATIVE AMERICAN FRESHWATER STUDIES**

*Wolfe and Walker (1987) - Subsistence Economies in Alaska: Productivity, Geography, and Development Impacts* - Wolfe and Walker (1987) analyzed a dataset from 98 communities for harvests of fish, land mammals, marine mammals, and other wild resources. The analysis was performed to evaluate the distribution and productivity of subsistence harvests in Alaska during the 1980s. Harvest levels were used as a measure of productivity. Wolfe and Walker (1987) defined harvest to represent a single year's production from a complete seasonal round. The harvest levels were derived primarily from a compilation of data from subsistence studies conducted between 1980 to 1985 by various researchers in the Alaska Department of Fish and Game, Division of Subsistence.

Of the 98 communities studied, four were large urban population centers and 94 were small communities. The harvests for these latter 94 communities were documented through detailed retrospective interviews with harvesters from a sample of households (Wolfe and Walker, 1987). Harvesters were asked to estimate the quantities of a particular species that were harvested and used by members of that household during the previous 12-month period. Wolfe and Walker (1987) converted harvests to a common unit for comparison, pounds dressed weight per capita per year, by multiplying the harvests of households within each community by standard factors converting total pounds to dressed weight, summing across households, and then dividing by the total number of household members in the household sample. Dressed weight varied by species and community but in general was 70 to 75 percent of total fish weight; dressed weight for fish represents that portion brought into the kitchen for use (Wolfe and Walker, 1987).

Harvests for the four urban populations were developed from a statewide data set gathered by the Alaska Department of Fish and Game Divisions of Game and Sports Fish. Urban sport fish harvest estimates were derived from a survey that was mailed to a randomly selected statewide sample of anglers (Wolfe and Walker, 1987). Sport fish harvests were disaggregated by urban residency and the dataset was analyzed by converting the harvests into pounds and dividing by the 1983 urban population.

For the overall analysis, each of the 98 communities was treated as a single unit of analysis and the entire group of communities was assumed to be a sample of all communities in Alaska (Wolfe and Walker, 1987). Each community was given equal weight, regardless of population size. Annual per capita harvests were calculated for each community. For the four urban centers, fish harvests ranged from 5 to 21 pounds per capita per year (6.2 g/day to 26.2 g/day).

The range for the 94 small communities was 25 to 1,239 pounds per capita per year (31 g/day to 1,541 g/day). For these 94 communities, the median per capita fish harvest was 130 pounds per year (162 g/day). In most (68 percent) of the 98 communities analyzed, resource harvests for fish were greater than the harvests of the other wildlife categories (land mammal, marine mammal, and other) combined.

The communities in this study were not made up entirely of Alaska Natives. For roughly half the communities, Alaska Natives comprised 80 percent or more of the population, but for about 40 percent of the communities they comprised less than 50 percent of the population. Wolfe and Walker (1987) performed a regression analysis which showed that the per capita harvest of a community tended to increase as a function of the percentage of Alaska Natives in the community. Although this analysis was done for total harvest (i.e., fish, land mammal, marine mammal and others) the same result should hold for fish harvest since fish harvest is highly correlated with total harvest.

A limitation of this report is that it presents (per-capita) harvest rates as opposed to individual intake rates. Wolfe and Walker (1987) compared the per capita harvest rates reported to the results for the household component of the 1977-1978 USDA National Food Consumption Survey (NFCS). The NFCS showed that about 222 pounds of meat, fish, and poultry were purchased and brought into the household kitchen for each person each year in the western region of the United States. This contrasts with a median total resource harvest of 260 lbs/yr in the 94 communities studied. This comparison, and the fact that Wolfe and Walker (1987) state that "harvests represent that portion brought into the kitchen for use," suggest that the same factors used to convert household consumption rates in the NFCS to individual intake rates can be used to convert per capita harvest rates to individual intake rates. In Section 10.3, a factor of 0.5 was used to convert fish consumption from household to individual intake rates. Applying this factor, the median



---

**Chapter 10 - Intake of Fish and Shellfish**

---

per capita individual fish intake in the 94 communities would be 81 g/day and the range 15.5 to 770 g/day.

A limitation of this study is that the data were based on 1-year recall from a mailed survey. An advantage of the study is that it is one of the few studies that present fish harvest patterns for subsistence populations.

*AIHC (1994) - Exposure Factors Sourcebook* - The Exposure Factors Sourcebook (AIHC, 1994) provides data for non-marine fish intake consistent with this document. However, the total fish intake rate recommended in AIHC (1994) is approximately 40 percent lower than that in this document. The fish intake rates presented in this handbook are based on more recent data from USDA CSFII (1989-1991). AIHC (1994) presents probability distributions in grams fish per kilogram of body weight for fish consumption based on data from U.S. EPA Guidance Manual, Assessing Human Health Risks from Chemically Contaminated Fish and Shellfish (U.S. EPA, 1989b). The @Risk formula is provided for direct use in the @Risk simulation software. The @Risk formula was provided for the distributions that were provided for the ingestion of freshwater finfish, saltwater finfish, and fish (unspecified) in the U.S. general population, children ages 1 to 6 years, and males ages 13 years and above. Distributions were also provided for saltwater finfish ingestion in the general population and for females and for males 13 years of age and older. Distributions for shellfish ingestion were provided for the general population, children ages 1 to 6 years, and for males and females 13 years of age and above. Additionally, distributions for "unspecified" fish ingestion were presented for the above mentioned populations.

The Sourcebook has been classified as a relevant rather than key study because it was not the primary source for the data used to make recommendations in this document. The Sourcebook is very similar to this document in the sense that it summarizes exposure factor data and recommends values. Therefore, it can be used as an alternative information source on fish intake.

*Columbia River Inter-Tribal Fish Commission (CRITFC) (1994) - A Fish Consumption Survey of the Umatilla, Nez Perce, Yakama, and Warm Springs Tribes of the Columbia River Basin* - CRITFC (1994) conducted a fish consumption survey among four Columbia River Basin Indian tribes during the fall and winter of 1991-1992. The target population included all adult tribal members who lived on or near the Yakama, Warm Springs, Umatilla or Nez Perce reservations. The survey

was based on a stratified random sampling design where respondents were selected from patient registration files at the Indian Health Service. Interviews were performed in person at a central location on the member's reservation.

Information requested included annual and seasonal numbers of fish meals, average serving size per fish meal, species and part(s) of fish consumed, preparation methods, changes in patterns of consumption over the last 20 years and during ceremonies and festivals, breast feeding practices and 24 hour dietary recall (CRITFC, 1994). Foam sponge food models approximating four, eight, and twelve ounce fish fillets were provided to help respondents estimate average fish meal size. Fish intake rates were calculated by multiplying the annual frequency of fish meals by the average serving size per fish meal.

The study was designed to give essentially equal sample sizes for each tribe. However, since the population sizes of the tribes were highly unequal, it was necessary to weight the data (in proportion to tribal population size) in order that the survey results represent the overall population of the four tribes. Such weights were applied to the analysis of adults; however, because the sample size for children was considered small, only an unweighted analysis was performed for this population (CRITFC, 1994).

The survey respondents consisted of 513 tribal members, 18 years old and above. Of these, 58 percent were female and 59 percent were under 40 years old. In addition, information for 204 children 5 years old and less was provided by the participating adult respondent. The overall response rate was 69 percent.

The results of the survey showed that adults consumed an average of 1.71 fish meals/week and had an average intake of 58.7 grams/day (CRITFC, 1994). Table 10-40 shows the adult fish intake distribution; the median was between 29 and 32 g/day and the 95th percentile about 170 g/day. A small percentage (7 percent) of respondents indicated that they were not fish consumers. Table 10-41 shows that mean intake was slightly higher in males than females (63 g/d versus 56 g/d) and was higher in the over 60 years age group (74.4 g/d) than in the 18-39 years (57.6 g/d) or 40-59 years (55.8 g/d) age groups. Intake also tended to be higher among those living on the reservation. The mean intake for nursing mothers, 59.1 g/d, was similar to the overall mean intake.

A total of 49 percent of respondents reported that they caught fish from the Columbia River basin and its



tributaries for personal use or for tribal ceremonies and distributions to other tribe members and 88 percent reported that they obtained fish from either self-harvesting, family or friends, at tribal ceremonies or from tribal distributions. Of all fish consumed, 41 percent came from self or family harvesting, 11 percent from the harvest of friends, 35 percent from tribal ceremonies or distribution, 9 percent from stores and 4 percent from other sources (CRITFC, 1994).

The analysis of seasonal intake showed that May and June tended to be high consumption months and December and January low consumption months. The mean adult intake rate for May and June was 108 g/d while the mean intake rate for December and January was 30.7 g/d. Salmon was the species eaten by the highest number of respondents (92 percent) followed by trout (70 percent), lamprey (54 percent), and smelt (52 percent). Table 10-42 gives the fish intake distribution for children under 5 years of age. The mean intake rate was 19.6 g/d and the 95th percentile was approximately 70 g/d.

The authors noted that some non-response bias may have occurred in the survey since respondents were more likely to live near the reservation and were more likely to be female than non-respondents. In addition, they hypothesized that non fish consumers may have been more likely to be non-respondents than fish consumers since non consumers may have thought their contribution to the survey would be meaningless; if such were the case, this study would overestimate the mean intake rate. It was also noted that the timing of the survey, which was conducted during low fish consumption months, may have led to underestimation of actual fish consumption; the authors conjectured that an individual may report higher annual consumption if interviewed during a relatively high consumption month and lower annual consumption if interviewed during a relatively low consumption month. Finally, with respect to children's intake, it was observed that some of the respondents provided the same information for their children as for themselves, thereby the reliability of some of these data is questioned.

Although the authors have noted these limitations, this study does present information on fish consumption patterns and habits for a Native American subpopulation. It should be noted that the number of surveys that address subsistence subpopulations is very limited.

*Peterson et al. (1994) - Fish Consumption Patterns and Blood Mercury Levels in Wisconsin Chippewa Indians* - Peterson et al. (1994) investigated the extent of exposure of methylmercury to Chippewa Indians living on

a Northern Wisconsin reservation who consume fish caught in northern Wisconsin lakes. The lakes in northern Wisconsin are known to be contaminated with mercury and the Chippewa have a reputation for high fish consumption (Peterson et al., 1994). The Chippewa Indians fish by the traditional method of spearfishing. Spearfishing (for walleye) occurs for about two weeks each spring after the ice breaks, and although only a small number of tribal members participate in it, the spearfishing harvest is distributed widely within the tribe by an informal distribution network of family and friends and through traditional tribal feasts (Peterson et al., 1994).

Potential survey participants, 465 adults, 18 years of age and older, were randomly selected from the tribal registries (Peterson et al., 1994). Participants were asked to complete a questionnaire describing their routine fish consumption and, more extensively, their fish consumption during the two previous months. They were also asked to give a blood sample that would be tested for mercury content. The survey was carried out in May 1990. A follow-up survey was conducted for a random sample of 75 non-respondents (80 percent were reachable), and their demographic and fish consumption patterns were obtained. Peterson et al. (1994) reported that the non-respondents' socioeconomic and fish consumption were similar to the respondents.

A total of 175 of the original random sample (38 percent) participated in the study. In addition, 152 nonrandomly selected participants were surveyed and included in the data analysis; these participants were reported by Peterson et al. (1994) to have fish consumption rates similar to those of the randomly selected participants. Results from the survey showed that fish consumption varied seasonally, with 50 percent of the respondents reporting April and May (spearfishing season) as the highest fish consumption months (Peterson et al., 1994). Table 10-43 shows the number of fish meals consumed per week during the last 2 months (recent consumption) before the survey was conducted and during the respondents' peak consumption months grouped by gender, age, education, and employment level. During peak consumption months, males consumed more fish (1.9 meals per week) than females (1.5 meals per week), respondents under 35 years of age consumed more fish (1.8 meals per week) than respondents 35 years of age and over (1.6 meals per week), and the unemployed consumed more fish (1.9 meals per week) than the employed (1.6 meals per week). During the highest fish consumption season (April and May), 50 percent of respondents



---

**Chapter 10 - Intake of Fish and Shellfish**

---

reported eating one or less fish meals per week and only 2 percent reported daily fish consumption (Figures 10-1 and 10-2). A total of 72 percent of respondents reported Walleye consumption in the previous two months. Peterson et al. (1994) also reported that the mean number of fish meals usually consumed per week by the respondents was 1.2.

The mean fish consumption rate reported (1.2 fish meals per week, or 62.4 meals per year) in this survey was compared with the rate reported in a previous survey of Wisconsin anglers (Fiore et al., 1989) of 42 fish meals per year. These results indicate that the Chippewa Indians do not consume much more fish than the general Wisconsin angler population (Peterson et al., 1994). The differences in the two values may be attributed to differences in study methodology (Peterson et al., 1994). Note that this number (1.2 fish meals per week) includes fish from all sources. Peterson et al. (1994) noted that subsistence fishing, defined as fishing as a major food source, appears rare among the Chippewa. Using the recommended rate in this handbook of 129 g/meal as the average weight of fish consumed per fish meal in the general population, the rate reported here of 1.2 fish meals per week translates into a mean fish intake rate of 22 g/day in this population.

*Fitzgerald et al. (1995) - Fish PCB Concentrations and Consumption Patterns Among Mohawk Women at Akwesasne* - Akwesasne is a native American community of ten thousand plus persons located along the St. Lawrence River (Fitzgerald et al., 1995). The local food chain has been contaminated with PCBs and some species have levels that exceed the U.S. FDA tolerance limits for human consumption (Fitzgerald et al., 1995). Fitzgerald et al. (1995) conducted a recall study from 1986 to 1992 to determine the fish consumption patterns among nursing Mohawk women residing near three industrial sites. The study sample consisted of 97 Mohawk women and 154 nursing Caucasian controls. The Mohawk mothers were significantly younger (mean age 24.9) than the controls (mean age 26.4) and had significantly more years of education (mean 13.1 for Mohawks versus 12.4 for controls). A total of 97 out of 119 Mohawk nursing women responded, a response rate of 78 percent; 154 out of 287 control nursing Caucasian women responded, a response rate of 54 percent.

Potential participants were identified prior to, or shortly after, delivery. The interviews were conducted at home within one month postpartum and were structured to collect information for sociodemographics, vital statistics, use of medications, occupational and residential histories,

behavioral patterns (cigarette smoking and alcohol consumption), drinking water source, diet, and fish preparation methods (Fitzgerald et al., 1995). The dietary data collected were based on recall for food intake during the index pregnancy, the year before the pregnancy, and more than one year before the pregnancy.

The dietary assessment involved the report by each participant on the consumption of various foods with emphasis on local species of fish and game (Fitzgerald et al., 1995). This method combined food frequency and dietary histories to estimate usual intake. Food frequency was evaluated with a checklist of foods for indicating the amount of consumption of a participant per week, month or year. Information gathered for the dietary history included duration of consumption, changes in the diet, and food preparation method.

Table 10-44 presents the number of local fish meals per year for both the Mohawk and control participants. The highest percentage of participants reported consuming between 1 and 9 local fish meals per year. Table 10-44 indicates that Mohawk respondents consumed statistically significantly more local fish than did control respondents during the two time periods prior to pregnancy; for the time period during pregnancy there was no significant difference in fish consumption between the two groups. Table 10-45 presents the mean number of local fish meals consumed per year by time period for all respondents and for those ever consuming (consumers only). A total of 82 (85 percent) Mohawk mothers and 72 (47 percent) control mothers reported ever consuming local fish. The mean number of local fish meals consumed per year by Mohawk respondents declined over time, from 23.4 (over one year before pregnancy) to 9.2 (less than one year before pregnancy) to 3.9 (during pregnancy); a similar decline was seen among consuming Mohawks only. There was also a decreasing trend over time in consumption among controls, though it was much less pronounced.

Table 10-46 presents the mean number of fish meals consumed per year for all participants by time period and selected characteristics (age, education, cigarette smoking, and alcohol consumption). Pairwise contrasts indicated that control participants over 34 years of age had the highest fish consumption of local fish meals (22.1) (Table 10-46). However, neither the overall nor pairwise differences by age among the Mohawk women over 34 years old were statistically significant, and may be due to the small sample size (N=6) (Fitzgerald et al., 1995). The most common fish consumed by Mohawk



mothers was yellow perch; for controls the most common fish consumed was trout.

An advantage of this study is that it presents data for fish consumption patterns for Native Americans as compared to a demographically similar group of Caucasians. Although the data are based on nursing mothers as participants, the study also captures consumption patterns prior to pregnancy (up to 1 year before and more than 1 year before). Fitzgerald et al. (1995) noted that dietary recall for a period more than one year before pregnancy may be inaccurate, but these data were the best available measure of the more distant past. They also noted that the observed decrease in fish consumption among Mohawks from the period one year before pregnancy to the period of pregnancy is due to a secular trend of declining fish consumption over time in Mohawks. This decrease, which was more pronounced than that seen in controls, may be due to health advisories promulgated by tribal, as well as state, officials. The authors note that this decreasing secular trend in Mohawks is consistent with a survey from 1979-1980 that found an overall mean of 40 fish meals per year among male and female Mohawk adults.

The data are presented as number of fish meals per year; the authors did not assign an average weight to fish meals. If assessors wanted to estimate the weight of fish consumed, some average value of weight per fish meal would have to be assumed. Pao et al. (1982) reported 104 grams as the average weight of fish consumed per eating occasion for females 19-34 years old.

**10.9. OTHER FACTORS**

Other factors to consider when using the available survey data include location, climate, season, and ethnicity of the angler or consumer population, as well as the parts of fish consumed and the methods of preparation. Some contaminants (for example, some dioxin compounds) have the affinity to accumulate more in certain tissues, such as the fatty tissue, as well as in certain internal organs. The effects of cooking methods for various food products on the levels of dioxin-like compounds have been addressed by evaluating a number of studies in U.S. EPA (1996b). These studies showed various results for contamination losses based on the methodology of the study and the method of food preparation. The reader is referred to U.S. EPA (1996b) for a detailed review of these studies. In addition, some studies suggest that there is a significant decrease of

contaminants in cooked fish when compared with raw fish (San Diego County, 1990). Several studies cited in this section have addressed fish preparation methods and parts of fish consumed. Table 10-47 provides summary results from these studies on fish preparation methods; further details on preparation methods, as well as results from some studies on parts of fish consumed, are presented in Appendix 10B.

The moisture content (percent) and total fat content (percent) measured and/or calculated in various fish forms (i.e., raw, cooked, smoked, etc.) for selected fish species are presented in Table 10-48, based on data from USDA (1979-1984). The total percent fat content is based on the sum of saturated, monounsaturated, and polyunsaturated fat. The moisture content is based on the percent of water present.

In some cases, the residue levels of contaminants in fish are reported as the concentration of contaminant per gram of fat. These contaminants are lipophilic compounds. When using residue levels, the assessor should ensure consistency in the exposure assessment calculations by using consumption rates that are based on the amount of fat consumed for the fish species of interest. Alternately, residue levels for the "as consumed" portions of fish may be estimated by multiplying the levels based on fat by the fraction of fat (Table 10-48) per product as follows:

The resulting residue levels may then be used in conjunction

$$\text{residue level/g product} = \left( \frac{\text{residue level}}{\text{g-fat}} \right) \times \left( \frac{\text{g-fat}}{\text{g-product}} \right) \quad (\text{Eqn. 10-4})$$

with "as consumed" consumption rates.

Additionally, intake rates may be reported in terms of units as consumed or units of dry weight. It is essential that exposure assessors be aware of this difference so that they may ensure consistency between the units used for intake rates and those used for concentration data (i.e., if the unit of food consumption is grams dry weight/day, then the unit for the amount of pollutant in the food should be grams dry weight). If necessary, as consumed intake rates may be converted to dry weight intake rates using the moisture content percentages of fish presented in Table 10-48 and the following equation:

$$IR_{dw} = IR_{ac} * [(100-W)/100] \quad (\text{Eqn. 10-5})$$



---

**Chapter 10 - Intake of Fish and Shellfish**

---

"Dry weight" intake rates may be converted to "as consumed" rates by using:

$IR_{ac} = IR_{dw} / [(100 - W) / 100]$	(Eqn. 10-6)
where:	
$IR_{dw}$	= dry weight intake rate;
$IR_{ac}$	= as consumed intake rate; and
$W$	= percent water content.

### 10.10. RECOMMENDATIONS

Fish consumption rates are recommended based on the survey results presented in the key studies described in the preceding sections. Considerable variation exists in the mean and upper percentile fish consumption rates obtained from these studies. This can be attributed largely to the characteristics of the survey population (i.e., general population, recreational anglers) and the type of water body (i.e., marine, estuarine, freshwater), but other factors such as study design, method of data collection and geographic location also play a role. Based on these study variations, recommendations for consumption rates were classified into the following categories:

- General Population;
- Recreational Marine Anglers;
- Recreational Freshwater Anglers; and
- Native American Subsistence Fishing Populations

The recommendations for each of these categories were rated according to the level of confidence the Agency has in the recommended values. These ratings were derived according to the principles outlined in Volume I, Section 1.3; the ratings and a summary of the rationale behind them are presented in tables which follow the discussion of each category.

For exposure assessment purposes, the selection of the appropriate category (or categories) from above will depend on the exposure scenario being evaluated. Assessors should use the recommended values (or range of values) unless specific studies are felt to be particularly relevant to their needs, in which case results from a specific study or studies may be used. This is particularly true for the last two categories where no nationwide key studies exist. Even where national data exist, it may be advantageous to use regional estimates if the assessment targets a particular region. In addition, seasonal, age, and gender variations should be considered when appropriate.

It should be noted that the recommended rates are based on mean (or median) values which represent a typical intake or central tendency for the population studied, and on upper estimates (i.e., 90th-99th percentiles) which represent the high-end fish consumption of the population studied. For the recreational angler populations, the recommended means and percentiles are based on all persons engaged in recreational fishing, not just those consuming recreationally caught fish.

#### 10.10.1. Recommendations - General Population

The key study for estimating mean fish intake (reflective of both short-term and long-term consumption) is U.S. EPA (1996a) analysis of USDA CSFII 1989-1991. The recommended values for mean intake by habitat and fish type are shown in Table 10-49.

For all fish (finfish and shellfish), the recommended values are 6.6 g/day for freshwater/ estuarine fish, 13.5 g/day for marine fish, and 20.1 g/day for all fish. Note that these values are reported as uncooked fish weight. This is important because the concentration of the contaminants in fish are generally measured in the uncooked samples. Assuming that cooking results in some reductions in weight (e.g., loss of moisture), and the mass of the contaminant in the fish tissue remains constant, then the contaminant concentration in the cooked fish tissue will increase. Although actual consumption may be overestimated when intake is expressed in an uncooked basis, the net effect on the dose may be canceled out since the actual concentration may be underestimated when it is based on the uncooked sample. On the other hand, if the "as consumed" intake rate and the uncooked concentration are used in the dose equation, dose may be underestimated since the concentration in the cooked fish is likely to be higher, if the mass of the contaminant remains constant after cooking. Therefore, it is more conservative and appropriate to use uncooked fish intake rates. If concentration data can be adjusted to account for changes after cooking, then the "as consumed" intake rates are appropriate. For example, concentration may be expressed on a dry weight basis and, if data are available, loss of contaminant mass after cooking may be accounted for in the concentration. However, data on the effects of cooking in contaminant concentrations are limited and assessors generally make the conservative assumption that cooking has no effect on the contaminant mass. Both "as consumed" and uncooked fish intake values have been



presented in this handbook so that the assessor can choose the intake data that best matches the concentration data that is being used.

CSFII data were based on a short-term survey and could not be used to estimate the distribution over the long term of the average daily fish intake. The long-term average daily fish intake distribution can be estimated using the TRI study which provided dietary data for a one month period. However, because the data from the TRI study are now over 20 years old, the value presented in Table 10-49 (56 g/day) has been adjusted by upward 25 percent based on Ruffle et al. (1994) to reflect the increase in fish consumption since the TRI survey was conducted. In addition to the arguments provided by Ruffle et al. (1994) for adjusting the data upward, recent data from CSFII 1989-91 indicate an increase of fish intake of 33 percent when compared to USDA NFCS data from 1977-78. Therefore, the adjustment recommended by Ruffle et al. (1994) of 25 percent seems appropriate. Then, as suggested by Ruffle et al. (1994) the distributions generated from TRI should be shifted upward by 25 percent to estimate the current fish intake distribution. Thus, the recommended percentiles of long-term average daily fish intake are those of Javitz (1980) adjusted 25 percent upward (see Tables 10-3, 10-4). Alternatively, the log-normal distribution of Ruffle et al. (1994) (Table 10-6) may be used to approximate the long term fish intake distribution; adjusting the log mean  $\mu$  by adding  $\log(1.5)=0.4$ , will shift the distribution upward by 25 percent.

It is important to note that a limitation with these data is that the total amount of fish reported by respondents included fish from all sources (e.g., fresh, frozen, canned, domestic, international origin). Neither the TRI nor the CSFII surveys identified the source of the fish consumed. This type of information may be relevant for some assessments. It should be noted that because these recommendations are based on 1989-91 CSFII data, they may not reflect the most recent changes that may have occurred in consumption patterns. However, as indicated in Section 10.2, the 1989-91 CSFII data are believed to be appropriate for assessing ingestion exposure for current populations because the rate of fish ingestion did not change dramatically between 1977-78 and 1995.

The distribution of serving sizes may be useful for acute exposure assessments. The recommended values are 129 grams for mean serving size and 326 grams for

the 95th percentile serving size based on the CSFII analyses (Table 10-50).

#### **10.10.2. Recommendations - Recreational Marine Anglers**

The recommended values presented in Table 10-51 are based on the surveys of the National Marine Fisheries Service (NMFS, 1993). The intake values are based on finfish consumption only.

#### **10.10.3. Recommendations - Recreational Freshwater Anglers**

The data presented in Table 10-52 are based on mailed questionnaire surveys (Ebert et al., 1993 and West et al., 1989; 1993) and a diary study (Connelly et al., 1992; 1996). The mean intakes ranged from 5-17 g/day. The recommended mean and 95th percentile values for recreational freshwater anglers are 8 g/day and 25 g/day, respectively; these were derived by averaging the values from the three populations surveyed in the key studies. Since the two West et al. surveys studied the same population, the average of the means from the two studies was used to represent the mean for this population. The estimate from the West et al. (1989) survey was used to represent the 95th percentile for this population since the long term consumption percentiles could not be estimated from the West et al. (1993) study.

#### **10.10.4. Recommendations - Native American Subsistence Populations**

Fish consumption data for Native American subsistence populations are very limited. The CRITFC (1994) study gives a per-capita fish intake rate of 59 g/day and a 95th percentile of 170 g/day. The report by Wolfe and Walker (1987) presents harvest rates for 94 small communities engaged in subsistence harvests of natural resources. A factor of 0.5 was employed to convert the per-capita harvest rates presented in Wolfe and Walker (1987) to per capita individual consumption rates; this is the same factor used to convert from per capita household consumption rates to per capita individual consumption rates in the analysis of homegrown fish consumption from the 1987-1988 NFCS. Based on this factor, the median per-capita harvest in the 94 communities of 162 g/day (and the range of 31-1,540 g/day) is converted to the median per capita intake rate of 81 g/day (range 16-770 g/day) shown in Table 10-53. The recommended value for mean intake is 70 g/day and the recommended 95th percentile is 170 g/day.



It should be emphasized that the above recommendations refer only to Native American subsistence fishing populations, not the Native American general population. Several studies show that intake rates of recreationally caught fish among Native Americans with state fishing licenses (West et al., 1989; Ebert et al., 1993) are somewhat higher (50-100 percent) than intake rates among other anglers, but far lower than the rates shown above for Native American subsistence populations.

In addition, the studies of Peterson et al. (1994) and Fiore et al. (1989) show that total fish intake among a Native American population on a reservation (Chippewa in Wisconsin) is roughly comparable (50 percent higher) to total fish intake among licensed anglers in the same state. Also, the study of Fitzgerald et al. (1995) showed that pregnant women on a reservation (Mohawk in New York) have sport-caught fish intake rates comparable to those of a local white control population.

The survey designs, data generated, and limitations/advantages of the studies described in this report are summarized and presented in Table 10-54. The confidence in recommendations is presented in Table 10-55. The confidence rating for recreational marine anglers is presented in Table 10-56. Confidence in fish intake recommendations for recreational freshwater fish consumption is presented in Table 10-57. The confidence in intake recommendations for Native American subsistence populations is presented in Table 10-58.

#### **10.11. REFERENCES FOR CHAPTER 10**

American Industrial Hygiene Council (AIHC) (1994) Exposure factors sourcebook. AIHC, Washington, DC.

ChemRisk (1991) Consumption of freshwater fish by maine anglers. Portland, ME: ChemRisk.

Columbia River Inter-Tribal Fish Commission (CRITFC). (1994) A fish consumption survey of the Umatilla, Nez Perce, Yakama and Warm Springs tribes of the Columbia River Basin. Technical Report 94-3. Portland, OR: CRITFC.

Connelly, N.A.; Knuth, B.A.; Bisogni, C.A. (1992) Effects of the health advisory and advisory changes on fishing habits and fish consumption in New York sport fisheries. Human Dimension Research Unit, Department of Natural Resources, New York State College of Agriculture and Life Sciences, Fernow Hall, Cornell University, Ithaca, NY.

Report for the New York Sea Grant Institute Project No. R/FHD-2-PD. September.

Connelly, N.A.; Knuth, B.A.; Brown, T.L. (1996) Sportfish consumption patterns of Lake Ontario anglers and the relationship to health advisories. N. Am. J. Fisheries Management, 16:90-101.

Ebert, E.; Harrington, N.; Boyle, K.; Knight, J.; Keenan, R. (1993) Estimating consumption of freshwater fish among Maine anglers. N. Am. J. Fisheries Management 13:737-745.

Fiore, B.J.; Anderson, H.A.; Hanrahan, L.P.; Olsen, L.J.; Sonzogni, W.C. (1989) Sport fish consumption and body burden levels of chlorinated hydrocarbons: A study of Wisconsin anglers. Arch. Environ. Health 44:82-88.

Fitzgerald, E.; Hwang, S.A.; Briz, K.A.; Bush, B.; Cook, K.; Worswick, P. (1995) Fish PCB concentrations and consumption patterns among Mohawk women at Akwesasne. J. Exp. Anal. Environ. Epid. 5(1):1-19.

Hudson River Sloop Clearwater, Inc. (1993) Hudson River angler survey. Hudson River Sloop Clearwater, Inc., Poughkeepsie, NY.

Javitz, H. (1980) Seafood consumption data analysis. SRI International. Final report prepared for EPA Office of Water Regulations and Standards. EPA Contract 68-01-3887.

National Marine Fisheries Service (NMFS). (1986a) Fisheries of the United States, 1985. Current Fisheries Statistics No. 8368. U.S. Department of Commerce, National Oceanic and Atmospheric Administration.

National Marine Fisheries Service (NMFS). (1986b) National Marine Fisheries Service. Marine Recreational Fishery Statistics Survey, Atlantic and Gulf Coasts, 1985. Current Fisheries Statistics No. 8327. U.S. Department of Commerce, National Oceanic and Atmospheric Administration.

National Marine Fisheries Service (NMFS). (1986c) National Marine Fisheries Service. Marine Recreational Fishery Statistics Survey, Pacific Coast. Current Fisheries Statistics No. 8328. U.S. Department of Commerce, National Oceanic and Atmospheric Administration.

National Marine Fisheries Service (NMFS). (1993) Data tapes for the 1993 NMFS provided to U.S. EPA, National Center for Environmental Assessments.





- Pao, E.M.; Fleming, K.H.; Guenther, P.M.; Mickle, S.J. (1982) Foods commonly eaten by individuals: amount per day and per eating occasion. U.S. Department of Agriculture. Home Economics Report No. 44.
- Peterson, D.; Kanarek, M.; Kuykendall, M.; Diedrich, J.; Anderson, H.; Remington, P.; Sheffy, T. (1994) Fish consumption patterns and blood mercury levels in Wisconsin Chippewa Indians. *Archives. Environ. Health*, 49:53-58.
- Pierce, R.S.; Noviello, D.T.; Rogers, S.H. (1981) Commencement Bay seafood consumption report. Preliminary report. Tacoma, WA: Tacoma-Pierce County Health Department.
- Price, P.; Su, S.; Gray, M. (1994) The effects of sampling bias on estimates of angler consumption rates in creel surveys. Portland, ME: ChemRisk.
- Puffer, H.W., Azen, S.P.; Duda, M.J.; Young, D.R. (1981) Consumption rates of potentially hazardous marine fish caught in the metropolitan Los Angeles area. EPA Grant #R807 120010.
- Ruffle, B.; Burmaster, D.; Anderson, P.; Gordon, D. (1994) Lognormal distributions for fish consumption by the general U.S. population. *Risk Analysis* 14(4):395-404.
- Rupp, E.; Miler, F.L.; Baes, C.F. III. (1980) Some results of recent surveys of fish and shellfish consumption by age and region of U.S. residents. *Health Physics* 39:165-175.
- San Diego County. (1990) San Diego Bay health risk study. San Diego, CA. San Diego County Department of Health Services.
- Tsang, A.M.; Klepeis, N.E. (1996) Results tables from a detailed analysis of the National Human Activity Pattern Survey (NHAPS) response. Draft Report prepared for the U.S. Environmental Protection Agency by Lockheed Martin, Contract No. 68-W6-001, Delivery Order No. 13.
- USDA. (1979-1984) Agricultural Handbook No. 8.
- USDA. (1989-1991) Continuing Survey of Food Intakes by Individuals (CSFII). U.S. Department of Agriculture.
- USDA. (1992a) Changes in food consumption and expenditures in American households during the 1980's. U.S. Department of Agriculture. Washington, D.C. Statistical Bulletin No. 849.
- USDA. (1992b) U.S. Department of Agriculture, Human Nutrition Information Service. Food and nutrient intakes by individuals in the United States, 1 day, 1987-88: Nationwide Food Consumption Survey 1987-88, NFCS Rpt. No. 87-I-1, in preparation.
- USDA. (1996a) Data tables: results from USDA's 1994 Continuing Survey of Food Intakes by Individuals and 1994 Diet and Health Knowledge Survey. U.S. Department of Agriculture, Agricultural Research Service, Riverdale, MD.
- USDA. (1996b) Data tables: results from USDA's 1995 Continuing Survey of Food Intakes by Individuals and 1995 Diet and Health Knowledge Survey. U.S. Department of Agriculture, Agricultural Research Service, Riverdale, MD.
- U.S. DHHS. (1995) Final Report: Health study to assess the human health effects of mercury exposure to fish consumed from the Everglades. Prepared by the Florida Department of Health and Rehabilitative Services for the U.S. Department of Health and Human Services, Atlanta, Georgia. PB95-167276.
- U.S. EPA. (1984) Ambient water quality criteria for 2,3,7,8-tetrachloro-dibenzo-p-dioxin. Washington, DC: Office of Water Regulations and Standards. EPA 440/5-84-007.
- U.S. EPA. (1989a) Exposure factors handbook. Washington, DC: Office of Health and Environmental Assessment,
- U.S. EPA. (1989b) Assessing human health risks from chemically contaminated fish and shellfish: a guidance manual. Washington, DC: Office of Marine and Estuarine Protection. EPA 503/8-89-002.
- U.S. EPA. (1992) Consumption surveys for fish and shellfish; a review and analysis of survey methods. Washington, DC: Office of Water. EPA 822/R-92-001.
- U.S. EPA. (1995) Fish consumption estimates based on the 1991-92 Michigan sport anglers fish consumption study. Final Report. Prepared by SAIC for the Office of Science and Technology.
- U.S. EPA. (1996a) Daily average per capita fish consumption estimates based on the combined USDA 1989, 1990 and 1991 continuing survey of food intakes by individuals (CSFII) 1989-91 data. Volumes I and II. Preliminary Draft Report. Washington, DC: Office of Water.
- U.S. EPA. (1996b) Estimating exposure to dioxin-like compounds. (Draft). Washington, DC: Office of Research and Development, National Center for Environmental Assessment.



---

*Chapter 10 - Intake of Fish and Shellfish*

---

West, P.C.; Fly, M.J.; Marans, R.; Larkin, F. (1989) Michigan sport anglers fish consumption survey. A report to the Michigan Toxic Substance Control Commission. Michigan Department of Management and Budget Contract No. 87-20141.

West, P.C.; Fly, J.M.; Marans, R.; Larkin, F.; Rosenblatt, D. (1993) 1991-92 Michigan sport anglers fish consumption study. Prepared by the University of Michigan, School of Natural Resources for the Michigan Department of Natural Resources, Ann Arbor, MI. Technical Report No. 6. May.

Wolfe, R.J.; Walker, R.J. (1987) Subsistence economics in Alaska: productivity, geography, and development impacts. *Arctic Anthropology* 24(2):56-81.



Table 10-1. Total Fish Consumption by Demographic Variables<sup>a</sup>

Demographic Category	Intake (g/person/day)	
	Mean	95th Percentile
<u>Race</u>		
Caucasian	14.2	41.2
Black	16.0	45.2
Oriental	21.0	67.3
Other	13.2	29.4
<u>Sex</u>		
Female	13.2	38.4
Male	15.6	44.8
<u>Age (years)</u>		
0-9	6.2	16.5
10-19	10.1	26.8
20-29	14.5	38.3
30-39	15.8	42.9
40-49	17.4	48.1
50-59	20.9	53.4
60-69	21.7	55.4
70+	13.3	39.8
<u>Census Region</u>		
New England	16.3	46.5
Middle Atlantic	16.2	47.8
East North Central	12.9	36.9
West North Central	12.0	35.2
South Atlantic	15.2	44.1
East South Central	13.0	38.4
West South Central	14.4	43.6
Mountain	12.1	32.1
Pacific	14.2	39.6
<u>Community Type</u>		
Rural, non-SMSA	13.0	38.3
Central city, 2M or more	19.0	55.6
Outside central city, 2M or more	15.9	47.3
Central city, 1M - 2M	15.4	41.7
Outside central city, 1M - 2M	14.5	41.5
Central city, 500K - 1M	14.2	41.0
Outside central city, 500K - 1M	14.0	39.7
Outside central city, 250K - 500K	12.2	32.1
Central city, 250K - 500K	14.1	40.5
Central city, 50K - 250K	13.8	43.4
Outside central city, 50K - 250K	11.3	31.7
Other urban	13.5	39.2
<sup>a</sup> The calculations in this table are based on respondents who consumed fish during the survey month. These respondents are estimated to represent 94 percent of the U.S. population. Source: Javitz, 1980.		



Table 10-2. Mean and 95th Percentile of Fish Consumption (g/day) by Sex and Age <sup>a</sup>				
	Age (years)	Total Fish		
		Mean	95th Percentile	
Female	0 - 9	6.1	17.3	
	10 - 19	9.0	25.0	
	20 - 19	13.4	34.5	
	30 - 39	14.9	41.8	
	40 - 49	16.7	49.6	
	50 - 59	19.5	50.1	
	60 - 69	19.0	46.3	
Male	70+	10.7	31.7	
	0 - 9	6.3	15.8	
	10 - 19	11.2	29.1	
	20 - 19	16.1	43.7	
	30 - 39	17.0	45.6	
	40 - 49	18.2	47.7	
	50 - 59	22.8	57.5	
Overall	60 - 69	24.4	61.1	
	70+	15.8	45.7	
Overall		14.3	41.7	

<sup>a</sup> The calculations in this table are based upon respondents who consumed fish in the month of the survey. These respondents are estimated to represent 94.0% of the U.S. population.  
Source: Javitz, 1980.



Table 10-3. Percent Distribution of Total Fish Consumption for Females by Age

Age (yrs)	Consumption Category (g/day)										
	0.0-5.0	5.1-10.0	10.1-15.0	15.1-20.0	20.1-25.0	25.1-30.0	30.1-37.5	37.6-47.5	47.6-60.0	60.1-122.5	over 122.5
	Percentage										
0-9	55.5	26.8	11.0	3.7	1.0	1.1	0.7	0.3	0.0	0.0	0.0
10-19	17.8	31.4	15.4	6.9	3.5	2.4	1.2	0.7	0.2	0.4	0.0
20-29	28.1	26.1	20.4	11.8	6.7	3.5	4.4	2.2	0.9	0.9	0.0
30-39	22.4	23.6	18.0	12.7	8.3	4.8	3.8	2.8	1.9	1.7	0.1
40-49	17.5	21.9	20.7	13.2	9.3	4.5	4.6	2.8	3.4	2.1	0.2
50-59	17.0	17.4	16.8	15.5	10.5	8.5	6.8	5.2	4.2	2.0	0.2
60-69	11.5	16.9	20.6	15.9	9.1	9.2	6.0	6.1	2.4	2.1	0.2
70+	41.9	22.1	12.3	9.7	5.2	2.9	2.6	1.2	0.8	1.2	0.1
Overall	28.9	24.0	16.8	10.7	6.4	4.3	3.5	2.4	1.6	1.2	0.1

<sup>a</sup> The percentage of females in an age bracket whose average daily fish consumption is within the specified range. The calculations in this table are based upon the respondents who consumed fish during the month of the survey. These respondents are estimated to represent 94% of the U.S. population. Source: Javitz, 1980.

Table 10-4. Percent Distribution of Total Fish Consumption for Males by Age

Age (yrs)	Consumption Category (g/day)										
	0.0-5.0	5.1-10.0	10.1-15.0	15.1-20.0	20.1-25.0	25.1-30.0	30.1-37.5	37.6-47.5	47.6-60.0	60.1-122.5	over 122.5
	Percentage										
0-9	52.1	30.1	11.9	3.1	1.2	0.6	0.7	0.1	0.2	0.1	0.0
10-19	27.8	29.3	19.0	10.4	6.0	3.2	1.7	1.7	0.4	0.5	0.0
20-29	16.7	22.9	19.6	14.5	8.8	6.2	4.4	3.1	1.9	1.9	0.1
30-39	16.6	21.2	19.2	13.2	9.5	7.3	5.2	3.2	1.3	2.2	0.0
40-49	11.9	22.3	18.6	14.7	8.4	8.5	5.3	5.2	3.3	1.7	0.1
50-59	9.9	15.2	15.4	14.4	10.4	9.7	8.7	7.6	4.3	4.1	0.2
60-69	7.4	15.0	15.6	12.8	11.4	8.5	9.9	8.3	5.5	5.5	0.1
70+	24.5	21.7	15.7	9.9	9.8	5.3	5.4	3.1	1.7	2.8	0.1
Overall	22.6	23.1	17.0	11.3	7.7	5.7	4.6	3.6	2.2	2.1	0.1

<sup>a</sup> The percentage of males in an age bracket whose average daily fish consumption is within the specified range. The calculations in this table are based upon respondents who consumed fish during the month of the survey. These respondents are estimated to represent 94% of the U.S. population. Source: Javitz, 1980.



Chapter 10 - Intake of Fish and Shellfish

Table 10-5. Mean Total Fish Consumption by Species<sup>a</sup>

Species	Mean consumption (g/day)	Species	Mean consumption (g/day)
Not reported	1.173	Mullet <sup>b</sup>	0.029
Abalone	0.014	Oysters <sup>b</sup>	0.291
Anchovies	0.010	Perch (Freshwater) <sup>b</sup>	0.062
Bass <sup>b</sup>	0.258	Perch (Marine) <sup>b</sup>	0.773
Bluefish	0.070	Pike (Marine) <sup>b</sup>	0.154
Bluegills <sup>b</sup>	0.089	Pollock	0.266
Bonito <sup>b</sup>	0.035	Pompano	0.004
Buffalofish	0.022	Rockfish	0.027
Butterfish	0.010	Sablefish	0.002
Carp <sup>b</sup>	0.016	Salmon <sup>b</sup>	0.533
Catfish (Freshwater) <sup>b</sup>	0.292	Scallops <sup>b</sup>	0.127
Catfish (Marine) <sup>b</sup>	0.014	Scup <sup>b</sup>	0.014
Clams <sup>b</sup>	0.442	Sharks	0.001
Cod	0.407	Shrimp <sup>b</sup>	1.464
Crab, King	0.030	Smelt <sup>b</sup>	0.057
Crab, other than King <sup>b</sup>	0.254	Snapper	0.146
Crappie <sup>b</sup>	0.076	Snook <sup>b</sup>	0.005
Croaker <sup>b</sup>	0.028	Spot <sup>b</sup>	0.046
Dolphin <sup>b</sup>	0.012	Squid and Octopi	0.016
Drums	0.019	Sunfish	0.020
Flounders <sup>b</sup>	1.179	Swordfish	0.012
Groupers	0.026	Tilefish	0.003
Haddock	0.399	Trout (Freshwater) <sup>b</sup>	0.294
Hake	0.117	Trout (Marine) <sup>b</sup>	0.070
Halibut <sup>b</sup>	0.170	Tuna, light	3.491
Herring	0.224	Tuna, White Albacore	0.008
Kingfish	0.009	Whitefish <sup>b</sup>	0.141
Lobster (Northern) <sup>b</sup>	0.162	Other finfish <sup>b</sup>	0.403
Lobster (Spiny)	0.074	Other shellfish <sup>b</sup>	0.013
Mackerel, Jack	0.002		
Mackerel, other than Jack	0.172		

<sup>a</sup> The calculations in this table are based upon respondents who consumed fish during the month of the survey. These respondents are estimated to represent 94% percent of the U.S. population.  
<sup>b</sup> Designated as freshwater or estuarine species by Stephan (1980).  
 Source: Javitz, 1980.

Table 10-6. Best Fits of Lognormal Distributions Using the NonLinear Optimization (NLO) Method

	Adults	Teenagers	Children
<b>Shellfish</b>			
$\mu$	1.370	-0.183	0.854
$\sigma$	0.858	1.092	0.730
(min SS)	27.57	1.19	16.06
<b>Finfish (freshwater)</b>			
$\mu$	0.334	0.578	-0.559
$\sigma$	1.183	0.822	1.141
(min SS)	6.45	23.51	2.19
<b>Finfish (saltwater)</b>			
$\mu$	2.311	1.691	0.881
$\sigma$	0.72	0.830	0.970
(min SS)	30.13	0.33	4.31

The following equations may be used with the appropriate  $\mu$  and  $\sigma$  values to obtain an average Daily Consumption Rate (DCR), in grams, and percentiles of the DCR distribution.  
 $DCR_{50} = \exp(\mu)$   
 $DCR_{90} = \exp[\mu + z(0.90) \cdot \sigma]$   
 $DCR_{99} = \exp[\mu + z(0.99) \cdot \sigma]$   
 $DCR_{avg} = \exp[\mu + 0.5 \cdot \sigma^2]$   
 Source: Ruffle et al., 1994.



Table 10-7. Per Capita Distribution of Fish Intake (g/day) by Habitat and Fish Type for the U.S. Population  
(Uncooked Fish Weight)

Habitat	Statistic	Estimate (90% Interval)		
		Finfish	Shellfish	Total
Fresh/Estuarine	Mean	3.6 (3.0 - 4.1)	2.4 (2.0 - 2.8)	6.0 (5.3 - 6.7)
	50th%	0.0 (0.0 - 0.0)	0.0 (0.0 - 0.0)	0.0 (0.0 - 0.0)
	90th%	0.4 (0.00 - 0.7)	0.0 (0.0 - 0.3)	15.9 (14.4 - 17.8)
	95th%	21.7 (14.8 - 25.8)	13.3 (11.7 - 17.8)	40.0 (37.9 - 44.8)
	99th%	87.3 (80.1 - 98.0)	63.6 (60.4 - 68.5)	107.6 (98.3 - 109.1)
Marine	Mean	12.5 (11.5 - 13.5)	1.6 (1.3 - 1.9)	14.1 (13.1 - 15.1)
	50th%	0.0 (0.0 - 0.0)	0.0 (0.0 - 0.0)	0.0 (0.0 - 0.0)
	90th%	47.5 (43.6 - 49.8)	0.0 (0.0 - 0.0)	52.1 (47.8 - 55.9)
	95th%	74.6 (70.3 - 76.3)	0.0 (0.0 - 6.8)	76.5 (74.6 - 80.9)
	99th%	133.0 (127.8 - 143.2)	50.3 (44.5 - 59.0)	138.2 (133.0 - 155.1)
All Fish	Mean	16.1 (15.0 - 17.2)	4.0 (3.4 - 4.6)	20.1 (18.8 - 21.4)
	50th%	0.0 (0.0 - 0.0)	0.0 (0.0 - 0.0)	0.0 (0.0 - 0.0)
	90th%	59.1 (54.6 - 62.3)	0.0 (0.0 - 3.5)	70.1 (65.4 - 74.2)
	95th%	84.4 (81.3 - 89.6)	22.7 (21.8 - 26.6)	102.0 (99.3 - 106.7)
	99th%	156.7 (148.7 - 168.1)	99.0 (87.8 - 109.6)	173.2 (162.8 - 176.5)

Note: Percentile confidence intervals estimated using the bootstrap method with 1,000 replications; percent consuming gives the percentage of individuals consuming the specified category of fish during the 3-day survey period. Estimates are projected from a sample of 11,912 individuals to the U.S. population.

Source: U.S. EPA, 1996a.



Table 10-8. Per Capita Distribution of Fish (Finfish and Shellfish) Intake (g/day) by Habitat for Consumers Only  
(Uncooked Fish Weight)

Habitat	Statistic	Estimate	90% Interval
Fresh/Estuarine <sup>a</sup>	Mean	86.2	78.4 - 94.0
	50th%	48.8	45.6 - 54.9
	90th%	217.9	205.3 - 237.3
	95th%	290.0	267.1 - 325.6
	99th%	489.3	424.9 - 534.2
	Percent Consuming	18.5	
Marine <sup>b</sup>	Mean	113.1	107.8 - 118.4
	50th%	93.3	92.0 - 94.9
	90th%	222.7	216.5 - 225.6
	95th%	271.7	260.6 - 279.9
	99th%	415.9	367.3 - 440.5
	Percent Consuming	30.1	
All Fish <sup>c</sup>	Mean	129.0	123.7 - 134.3
	50th%	101.9	98.9 - 103.9
	90th%	249.1	241.0 - 264.1
	95th%	326.0	306.1 - 335.6
	99th%	497.5	469.2 - 519.7
	Percent Consuming	36.9	

Note: Percentile confidence intervals estimated using the bootstrap method with 1,000 replications; percent consuming gives the percentage of individuals consuming the specified category of fish during the 3-day survey period.

- a Sample size = 1,892; population size = 44,946,000
- b Sample size = 3,184; population size = 73,100,000
- c Sample size = 3,927; population size = 89,800,000

Source: U.S. EPA, 1996a.





Table 10-9. Per Capita Distribution of Fish Intake (mg/kg-day) by Habitat and Fish Type for U.S. Population (Uncooked Fish Weight)

Habitat	Statistic	Estimate (90% Interval)		
		Finfish	Shellfish	Total
Fresh/Estuarine	Mean	58.1 (48.4 - 67.7)	35.9 (30.2 - 41.6)	94.0 (83.4 - 104.6)
	50th%	0.0 (0.0 - 0.0)	0.0 (0.0 - 0.0)	0.0 (0.0 - 0.0)
	90th%	5.9 (0.0 - 12.3)	0.0 (0.0 - 3.8)	251.8 (222.5 - 282.6)
	95th%	340.5 (252.9 - 410.1)	190.0 (155.7 - 268.3)	677.7 (631.9 - 729.1)
	99th%	1,401.9 (1,283.9 - 1,511.8)	953.5 (871.3 - 1,007.4)	1,593.3 (1,511.8 - 1,659.2)
Marine	Mean	215.8 (195.9 - 235.6)	24.3 (20.6 - 28.0)	240.1 (220.1 - 260.0)
	50th%	0.0 (0.0 - 0.0)	0.0 (0.0 - 0.0)	0.0 (0.0 - 0.0)
	90th%	783.4 (752.5 - 842.2)	0.0 (0.0 - 0.0)	855.6 (809.7 - 909.8)
	95th%	1,208.1 (1,149.5 - 1,264.9)	0.0 (0.0 - 88.8)	1,271.5 (1,227.2 - 1,371.2)
	99th%	2,400.0 (2,284.2 - 2,660.1)	701.3 (636.2 - 944.7)	2,575.3 (2,393.2 - 2,708.6)
All Fish	Mean	273.9 (252.0 - 295.7)	60.2 (52.3 - 68.2)	334.1 (311.3 - 356.9)
	50th%	0.0 (0.0 - 0.0)	0.0 (0.0 - 0.0)	0.0 (0.0 - 0.0)
	90th%	966.1 (893.3 - 1,039.5)	0.0 (0.0 - 47.4)	1,123.1 (1,090.8 - 1,179.0)
	95th%	1,434.3 (1,371.2 - 1,526.8)	372.5 (324.1 - 460.5)	1,684.2 (1,620.5 - 1,718.5)
	99th%	2,857.5 (2,649.6 - 3,003.6)	1,412.4 (1,296.0 - 1,552.1)	3,092.8 (2,973.7 - 3,250.2)

Note: Percentile intervals were estimated using the percentile bootstrap method with 1,000 bootstrap replications. Estimates are projected from a sample of 11,912 individuals to the U.S. population.

Source: U.S. EPA, 1996a.



Table 10-10. Per Capita Distribution of Fish (Finfish and Shellfish) Intake (mg/kg-day) by Habitat for Consumers Only (Uncooked Fish Weight)			
Habitat	Statistic	Estimate	90% Interval
Fresh/Estuarine <sup>a</sup>	Mean	1,363.4	1,242.2 - 1,484.7
	50th%	819.7	736.9 - 895.7
	90th%	3,325.1	3,232.6 - 3,677.0
	95th%	4,408.2	4,085.6 - 4,781.3
	99th%	7,957.5	6,979.2 - 8,921.0
	Percent Consuming		18.5
Marine <sup>b</sup>	Mean	1,927.0	1,829.5 - 2,024.4
	50th%	1,507.7	1,470.7 - 1,538.8
	90th%	3,752.9	3,632.0 - 4,001.2
	95th%	5,018.7	4,852.1 - 5,267.3
	99th%	8,448.3	7,215.7 - 9,136.9
	Percent Consuming		30.1
All Fish <sup>c</sup>	Mean	2,145.3	2,055.9 - 2,234.6
	50th%	1,662.8	1,610.7 - 1,720.1
	90th%	4,223.9	4,085.8 - 4,454.2
	95th%	5,477.9	5,163.3 - 5,686.0
	99th%	9,171.5	8,605.4 - 9,796.6
	Percent Consuming		36.9
<p>Note: Percentile confidence intervals estimated using the bootstrap method with 1,000 replications; percent consuming gives the percentage of individuals consuming the specified category of fish during the 3-day survey period.</p> <p>a Sample size = 1,892; population size = 44,946,000                      b Sample size = 3,184; population size = 73,100,000                      c Sample size = 3,927; population size = 89,800,000</p> <p>Source: U.S. EPA, 1996a.</p>			



Table 10-11. Per Capita Distribution of Fish Intake (g/day) by Habitat and Fish Type for the U.S. Population (Cooked Fish Weight - As Consumed)

Habitat	Statistic	Estimate (90% Interval)		
		Finfish	Shellfish	Total
Fresh/Estuarine	Mean	2.8 (2.4 - 3.3)	1.9 (1.6 - 2.2)	4.7 (4.2 - 5.3)
	50th%	0.0 (0.0 - 0.0)	0.0 (0.0 - 0.0)	0.0 (0.0 - 0.0)
	90th%	0.3 (0.0 - 0.7)	0.0 (0.0 - 0.2)	12.6 (10.9 - 14.0)
	95th%	17.2 (12.9 - 20.8)	10.1 (7.9 - 13.8)	32.2 (29.8 - 35.2)
	99th%	70.9 (60.3 - 75.7)	49.9 (45.6 - 56.4)	82.5 (77.2 - 86.4)
Marine	Mean	9.7 (9.0 - 10.5)	1.2 (1.0 - 1.4)	10.9 (10.1 - 11.7)
	50th%	0.0 (0.0 - 0.0)	0.0 (0.0 - 0.0)	0.0 (0.0 - 0.0)
	90th%	37.3 (33.7 - 37.4)	0.0 (0.0 - 0.0)	39.5 (37.3 - 42.9)
	95th%	56.2 (55.6 - 58.2)	0.0 (0.0 - 5.3)	59.6 (57.0 - 61.8)
	99th%	103.1 (98.5 - 112.0)	37.0 (35.4 - 44.5)	106.8 (104.6 - 114.6)
All Fish	Mean	12.6 (11.7 - 13.4)	3.1 (2.7 - 3.5)	15.7 (14.7 - 16.6)
	50th%	0.0 (0.0 - 0.0)	0.0 (0.0 - 0.0)	0.0 (0.0 - 0.0)
	90th%	46.0 (43.6 - 49.0)	0.0 (0.0 - 2.6)	55.0 (51.4 - 56.0)
	95th%	67.0 (63.0 - 70.7)	18.9 (16.7 - 22.1)	78.3 (75.2 - 80.6)
	99th%	119.1 (113.9 - 125.9)	74.3 (68.7 - 82.0)	133.5 (125.3 - 140.2)

Percentile intervals were estimated using the percentile bootstrap method with 1,000 bootstrap replications. Estimates are projected from a sample of 11,912 individuals to the U.S. population.

Source: U.S. EPA, 1996a.



Table 10-12. Per Capita Distribution of Fish Intake (g/day) by Habitat for Consumers Only  
(Cooked Fish Weight - As Consumed)

Habitat	Statistic	Estimate	90% Interval
Fresh/Estuarine <sup>a</sup>	Mean	68.0	61.9 - 74.1
	50th%	39.5	36.2 - 44.7
	90th%	170.8	158.7 - 181.8
	95th%	224.8	212.9 - 246.0
	99th%	374.7	336.5 - 341.3
	Percent Consuming	18.5	
Marine <sup>b</sup>	Mean	87.8	83.7 - 91.8
	50th%	71.8	69.7 - 74.2
	90th%	169.4	167.0 - 173.7
	95th%	208.5	198.1 - 221.7
	99th%	320.4	292.8 - 341.9
	Percent Consuming	30.1	
All Fish <sup>c</sup>	Mean	100.6	96.7 - 104.6
	50th%	80.8	79.3 - 83.9
	90th%	197.4	188.7 - 205.1
	95th%	253.4	231.5 - 264.5
	99th%	371.6	359.3 - 401.6
	Percent Consuming	36.9	

Note: Percentile confidence intervals estimated using the bootstrap method with 1,000 replications; percent consuming gives the percentage of individuals consuming the specified category of fish during the 3-day survey period.

a Sample size = 1,892; population size = 44,946,000

b Sample size = 3,184; population size = 73,100,000

c Sample size = 3,927; population size = 89,800,000

Source: U.S. EPA, 1996a.



Table 10-13. Per Capita Distribution of Fish (Finfish and Shellfish) Intake (g/day) for the U.S. Population by Age and Gender - As Consumed (Freshwater and Estuarine)					
Age	Sample Size	Mean (90% C.I.)	90th % (90% B.I.)	95th % (90% B.I.)	99th % (90% B.I.)
<b>Females</b>					
14 or under	1431	1.58 (1.06-2.10)	1.44 (0.00-4.07)	12.51 (6.00-14.20)	36.09 (28.53-43.20)
15 - 44	2891	4.28 (3.55-5.02)	10.90 (8.79-13.84)	28.80 (26.26-33.53)	70.87 (64.74-90.56)
45 or older	2340	5.27 (4.21-6.32)	18.72 (15.19-22.12)	34.67 (29.17-39.38)	85.35 (71.71-100.50)
All ages	6662	4.02 (3.43-4.61)	10.66 (8.11-13.19)	28.11 (23.14-31.27)	71.98 (60.38-86.40)
<b>Males</b>					
14 or under	1546	2.17 (1.32-3.02)	0.99 (0.21-6.67)	14.94 (11.88-22.33)	48.72 (37.48-52.29)
15 - 44	2151	6.14 (5.08-7.19)	18.19 (10.21-24.20)	48.61 (35.42-54.65)	96.32 (85.60-115.75)
45 or older	1553	7.12 (5.87-8.38)	22.67 (19.28-27.83)	46.62 (41.27-58.01)	103.07 (86.41-125.11)
All ages	5250	5.46 (4.81-6.11)	16.05 (12.41-19.30)	40.29 (35.92-43.73)	86.40 (78.37-103.07)
<b>Both Sexes</b>					
14 or under	2977	1.88 (1.36-2.40)	1.31 (0.00-4.33)	13.90 (9.32-15.05)	40.77 (35.15-44.82)
15 - 44	5042	5.17 (4.46-5.87)	13.88 (12.05-17.21)	36.21 (28.64-47.31)	86.14 (74.67-96.67)
45 or older	3893	6.11 (5.20-7.02)	21.48 (16.69-23.33)	40.55 (35.80-47.31)	88.18 (85.33-103.07)
All ages	11912	4.71 (4.17-5.25)	12.62 (10.91-13.98)	32.16 (29.81-35.15)	82.45 (77.17-86.40)

Percentile intervals (B.I.) were estimated using the percentile bootstrap method with 1,000 bootstrap replications.  
Source: U.S. EPA, 1996a.

Table 10-14. Per Capita Distribution of Fish (Finfish and Shellfish) Intake (g/day) for the U.S. Population by Age and Gender - As Consumed (Marine)					
Age	Sample Size	Mean (90% C.I.)	90th % (90% B.I.)	95th % (90% B.I.)	99th % (90% B.I.)
<b>Females</b>					
14 or under	1431	6.60 (5.16-8.05)	24.84 (18.67-31.20)	37.32 (32.27-42.05)	87.05 (63.26-112.06)
15 - 44	2891	9.97 (8.94-11.01)	36.83 (31.42-41.99)	55.53 (47.67-59.59)	105.32 (96.98-112.00)
45 or older	2340	12.59 (11.36-13.82)	42.92 (38.92-47.66)	63.85 (57.27-72.36)	103.08 (91.61-121.52)
All ages	6662	10.10 (9.27-10.93)	36.97 (34.86-37.33)	55.54 (51.67-56.98)	102.01 (97.67-110.69)
<b>Males</b>					
14 or under	1546	7.25 (5.72-8.79)	24.85 (19.92-33.85)	49.89 (42.09-56.45)	92.64 (65.87-132.39)
15 - 44	2151	13.33 (11.89-14.77)	52.73 (48.34-55.80)	71.49 (63.99-80.00)	116.51 (106.06-143.31)
45 or older	1553	13.32 (11.73-14.92)	50.39 (47.13-53.33)	64.51 (61.64-74.58)	116.86 (106.93-144.94)
All ages	5250	11.85 (10.75-12.95)	47.13 (44.52-49.80)	64.50 (62.46-67.53)	113.94 (103.47-130.00)
<b>Both Sexes</b>					
14 or under	2977	6.93 (5.63-8.23)	24.88 (22.64-28.08)	42.07 (38.15-48.96)	91.64 (68.59-112.06)
15 - 44	5042	11.58 (10.55-12.60)	44.24 (39.84-46.70)	62.18 (57.88-69.72)	110.07 (103.50-120.49)
45 or older	3893	12.92 (11.86-13.98)	46.51 (38.98-50.97)	64.19 (60.67-72.00)	113.33 (104.59-119.53)
All ages	11912	10.94 (10.14-11.73)	39.51 (37.29-42.91)	59.62 (57.03-61.84)	106.84 (104.59-114.55)

Percentile intervals (B.I.) were estimated using the percentile bootstrap method with 1,000 bootstrap replications.  
Source: U.S. EPA, 1996a.



Chapter 10 - Intake of Fish and Shellfish

Table 10-15. Per Capita Distribution of Fish (Finfish and Shellfish) Intake (g/day)  
for the U.S. Population by Age and Gender - As Consumed  
(All Fish)

Age	Sample Size	Mean (90% C.I.)	90th % (90% B.I.)	95th % (90% B.I.)	99th % (90% B.I.)
<b>Females</b>					
14 or under	1431	8.19 (6.53-9.84)	32.28 (26.78-37.33)	43.09 (37.99-51.55)	95.19 (63.26-113.96)
15 - 44	2891	14.25 (12.96-15.55)	47.13 (41.95-55.83)	71.58 (64.74-82.11)	120.84 (110.69-132.79)
45 or older	2340	17.86 (16.19-19.52)	56.70 (54.13-62.99)	81.94 (74.63-88.23)	130.51 (122.02-140.21)
All ages	6662	14.13 (13.07-15.18)	46.44 (43.63-49.67)	70.23 (67.27-73.91)	120.22 (112.06-126.07)
<b>Males</b>					
14 or under	1546	9.42 (7.60-11.25)	34.85 (27.77-42.09)	52.85 (49.93-62.50)	98.36 (71.74-132.39)
15 - 44	2151	19.46 (17.75-21.18)	68.60 (65.74-74.70)	93.65 (85.60-96.96)	149.07 (142.73-154.41)
45 or older	1553	20.45 (18.41-22.49)	64.44 (61.33-69.27)	87.21 (85.33-100.19)	168.49 (143.78-174.55)
All ages	5250	17.31 (16.04-18.59)	60.23 (56.91-62.99)	85.69 (80.61-93.32)	143.91 (135.35-154.15)
<b>Both Sexes</b>					
14 or under	2977	8.82 (7.39-10.24)	32.88 (27.97-37.11)	50.95 (44.64-53.86)	98.33 (86.40-113.96)
15 - 44	5042	16.74 (15.54-17.94)	57.88 (56.00-60.85)	84.59 (79.91-90.83)	138.21 (122.84-149.15)
45 or older	3893	19.03 (17.54-20.52)	61.32 (56.00-65.74)	86.21 (77.42-94.70)	143.91 (131.12-171.37)
All ages	11912	15.65 (14.67-16.63)	55.02 (51.38-56.00)	78.34 (75.21-80.56)	133.46 (125.27-140.21)

Percentile intervals (B.I.) were estimated using the percentile bootstrap method with 1,000 bootstrap replications.  
Source: U.S. EPA, 1996a.

Table 10-16. Per Capita Distribution of Fish (Finfish and Shellfish) Intake (g/day)  
for the U.S. Population Aged 18 Years and Older by Habitat - As Consumed

Habitat	Statistic	Grams/day		
		Estimate	90% Interval	
			Lower Bound	Upper Bound
Fresh/Estuarine	Mean	5.59	4.91	6.28
	50th %	0.00	0.00	0.00
	90th %	17.80	14.89	20.63
	95th %	39.04	36.13	42.16
	99th %	86.30	81.99	96.67
Marine	Mean	12.42	11.55	13.29
	50th %	0.00	0.00	0.00
	90th %	45.98	44.48	48.34
	95th %	64.08	61.61	68.05
	99th %	111.38	101.94	120.49
All Fish	Mean	18.01	16.85	19.17
	50th %	0.00	0.00	0.00
	90th %	60.64	57.06	64.63
	95th %	86.25	80.29	91.00
	99th %	142.96	134.23	154.15

Percentile intervals were estimated using the percentile bootstrap method with 1,000 bootstrap replications.  
Note: Estimates are projected from a sample of 8,478 individuals of age 18 and older to the U.S. population of 177,807,000 individuals of age 18 and older using 3-year combined survey weights.  
Source: U.S. EPA, 1996a.



Table 10-17. Per Capita Distribution of Fish (Finfish and Shellfish) Intake (mg/kg-day) for the U.S. Population by Age and Gender - As Consumed (Freshwater and Estuarine)

Age	Sample Size	Mean (90% C.I.)	90th % (90% B.I.)	95th % (90% B.I.)	99th % (90% B.I.)
<b>Females</b>					
14 or under	1431	67.12 (46.16-88.09)	57.30 (0.00-128.52)	460.16 (218.56-559.86)	1356.54 (1295.24-2118.93)
15 - 44	2891	66.22 (55.35-77.08)	174.96 (115.11-205.05)	451.04 (421.65-505.49)	1188.16 (977.85-1278.63)
45 or older	2340	78.29 (63.27-93.30)	273.63 (209.63-300.11)	548.66 (466.18-633.87)	1251.00 (1038.97-1324.90)
All ages	6662	70.32 (60.09-80.55)	177.91 (132.69-212.30)	497.30 (442.20-558.85)	1269.76 (1093.19-1328.24)
<b>Males</b>					
14 or under	1546	73.93 (44.89-102.96)	28.10 (8.86-231.33)	723.93 (423.52-785.58)	1290.10 (1279.82-1355.11)
15 - 44	2151	75.35 (62.00-88.70)	230.13 (132.30-309.85)	577.84 (410.09-706.31)	1132.23 (1028.61-1416.47)
45 or older	1553	86.75 (70.91-102.58)	291.50 (230.15-364.24)	584.96 (512.66-630.77)	1231.60 (1115.58-1566.68)
All ages	5250	78.36 (69.10-87.61)	231.57 (186.27-276.04)	589.22 (549.64-630.09)	1265.10 (1133.18-1355.11)
<b>Both Sexes</b>					
14 or under	2977	70.59 (53.29-87.89)	53.24 (0.00-118.48)	556.34 (417.11-683.80)	1347.67 (1279.82-1390.82)
15 - 44	5042	70.58 (61.27-79.89)	197.11 (154.78-229.29)	502.26 (410.09-604.29)	1167.57 (1021.96-1279.82)
45 or older	3893	82.12 (70.19-94.05)	286.93 (228.49-332.88)	566.30 (505.10-625.21)	1251.55 (1115.58-1324.90)
All ages	11912	74.16 (65.74-82.57)	204.00 (177.97-225.16)	547.64 (505.10-565.37)	1274.55 (1197.29-1324.90)

Percentile intervals (B.I.) were estimated using the percentile bootstrap method with 1,000 bootstrap replications.  
Source: U.S. EPA, 1996a.

Table 10-18. Per Capita Distribution of Fish (Finfish and Shellfish) Intake (mg/kg-day) for the U.S. Population by Age and Gender - As Consumed (Marine)

Age	Sample Size	Mean (90% C.I.)	90th % (90% B.I.)	95th % (90% B.I.)	99th % (90% B.I.)
<b>Females</b>					
14 or under	1431	256.90 (207.04-306.76)	936.94 (723.73-1055.43)	1545.15 (1260.24-1760.26)	3060.22 (2403.50-4354.46)
15 - 44	2891	159.79 (142.76-176.82)	573.49 (493.39-663.16)	873.73 (780.56-929.55)	1700.21 (1578.65-1815.48)
45 or older	2340	191.08 (171.33-210.83)	644.33 (608.39-725.83)	978.84 (881.06-1103.01)	1694.58 (1488.32-1791.84)
All ages	6662	190.61 (172.89-208.33)	658.64 (627.61-700.33)	1024.76 (958.94-1096.14)	1979.45 (1793.40-2137.78)
<b>Males</b>					
14 or under	1546	230.25 (188.33-272.17)	846.57 (734.83-987.18)	1504.37 (1320.60-1749.26)	2885.08 (2631.87-3430.60)
15 - 44	2151	165.92 (147.73-184.12)	626.85 (593.90-680.90)	933.05 (833.43-982.30)	1472.98 (1411.97-1525.47)
45 or older	1553	164.37 (144.87-183.87)	621.00 (562.90-691.03)	839.06 (800.23-946.97)	1422.94 (1293.89-1791.31)
All ages	5250	181.08 (163.00-199.15)	670.19 (622.62-714.53)	981.87 (934.45-1071.54)	1923.63 (1802.17-1972.86)
<b>Both Sexes</b>					
14 or under	2977	243.31 (202.43-284.18)	873.87 (741.53-1093.69)	1522.52 (1371.10-1587.20)	3059.93 (2732.63-3430.60)
15 - 44	5042	162.72 (148.13-177.31)	602.58 (564.88-648.54)	893.82 (856.58-940.85)	1576.09 (1503.11-1697.71)
45 or older	3893	178.99 (164.13-193.84)	628.06 (555.84-700.65)	914.67 (825.21-1040.75)	1568.85 (1483.71-1760.74)
All ages	11912	186.06 (170.81-201.31)	663.00 (627.39-717.18)	991.96 (960.40-1044.69)	1942.17 (1815.48-2042.99)

Percentile intervals were estimated using the percentile bootstrap method with 1,000 bootstrap replications.  
Source: U.S. EPA, 1996a.



Chapter 10 - Intake of Fish and Shellfish

Table 10-19. Per Capita Distribution of Fish (Finfish and Shellfish) Intake (mg/kg-day)  
for the U.S. Population by Age and Gender - As Consumed  
(All Fish)

Age	Sample Size	Mean (90% C.I.)	90th % (90% B.I.)	95th % (90% B.I.)	99th % (90% B.I.)
<b>Females</b>					
14 or under	1431	324.02 (264.25-383.80)	1091.52 (929.29-1407.54)	1690.99 (1513.97-2072.35)	3982.60 (3219.32-4568.45)
15 - 44	2891	226.01 (205.01-247.01)	755.51 (641.02-879.29)	1126.02 (975.49-1269.56)	2195.86 (1762.90-2310.54)
45 or older	2340	269.37 (243.36-295.38)	862.18 (796.63-955.82)	1296.64 (1186.00-1344.85)	2147.32 (1791.84-2354.25)
All ages	6662	260.93 (239.15-282.72)	873.61 (796.63-911.89)	1323.29 (1269.56-1418.85)	2361.12 (2272.41-2598.14)
<b>Males</b>					
14 or under	1546	304.17 (251.91-356.43)	1172.17	1575.43 (1496.19-1943.82)	3393.84 (2731.95-3733.22)
15 - 44	2151	241.27 (219.25-263.29)	(1085.62-1320.60)	1208.43 (1101.68-1266.32)	1760.48 (1611.45-1851.26)
45 or older	1553	251.12 (225.48-276.76)	867.70 (814.06-919.25)	1122.80 (1041.28-1266.18)	1922.33 (1786.53-2275.93)
All ages	5250	259.43 (239.81-279.06)	797.83 (762.30-858.52)	1298.95 (1224.82-1366.86)	2346.64 (1972.86-2631.87)
<b>Both Sexes</b>					
14 or under	2977	313.90 (268.42-359.38)	1128.26	1679.91 (1546.20-1848.43)	3419.49 (3184.04-3733.22)
15 - 44	5042	233.30 (216.16-250.44)	(1005.58-1320.60)	1155.30 (1102.57-1212.19)	2003.46 (1787.65-2182.19)
45 or older	3893	261.10 (240.34-281.87)	828.12 (771.73-868.89)	1249.97 (1101.32-1323.53)	1967.01 (1796.52-2257.50)
All ages	11912	260.22 (242.60-277.83)	818.10 (771.23-882.53)	1308.54 (1267.15-1346.71)	2356.54 (2224.54-2556.68)
880.47 (844.35-918.79)					

Percentile intervals (B.I.) were estimated using the percentile bootstrap method with 1,000 bootstrap replications.  
Source: U.S. EPA, 1996a.

Table 10-20. Per Capita Distribution of Fish (Finfish and Shellfish) Intake (mg/kg-day)  
for the U.S. Population Aged 18 Years and Older by Habitat - As Consumed

Habitat	Statistic	Estimate	90% Interval	
			Lower Bound	Upper Bound
Fresh/Estuarine	Mean	75.56	66.37	84.75
	50th %	0.00	0.00	0.00
	90th %	242.49	205.05	277.26
	95th %	547.61	493.47	587.37
	99th %	1,171.84	1,123.52	1,252.78
Marine	Mean	172.86	160.73	184.99
	50th %	0.00	0.00	0.00
	90th %	624.83	598.84	670.34
	95th %	911.05	877.29	952.66
	99th %	1,573.20	1,468.43	1,713.17
All Fish	Mean	248.42	232.19	264.64
	50th %	0.00	0.00	0.00
	90th %	829.02	791.06	872.61
	95th %	1,197.36	1,133.18	1,264.74
	99th %	2,014.67	1,839.55	2,180.87

Percentile intervals were estimated using the percentile bootstrap method with 1,000 bootstrap replications.  
Note: Estimates are projected from a sample of 8,478 individuals of age 18 and older to the population of 177,807,000 individuals of age 18 and older using 3-year combined survey weights.  
Source: U.S. EPA, 1996a.





Table 10-21. Per Capita Distribution of Fish (Finfish and Shellfish) Intake (g/day)  
for Consumers Only by Age and Gender - As Consumed  
(Freshwater and Estuarine)

Age	Sample Size	Mean (90% C.I.)	90th % (90% B.I.)	95th % (90% B.I.)	99th % (90% B.I.)
<b>Females</b>					
14 or under	138	38.44	91.30	128.97	182.66
15 - 44	445	61.40	148.83	185.44	363.56
45 or older	453	62.49	150.67	214.91	296.69
All ages	1036	58.82 (51.57-66.06)	145.65 (130.73-152.24)	190.28 (173.88-219.03)	330.41 (259.20-526.69)
<b>Males</b>					
14 or under	157	52.44	112.05	154.44	230.74
15 - 44	356	81.56	224.01	275.02	371.53
45 or older	343	82.23	192.31	255.68	449.09
All ages	856	77.50 (70.21-84.80)	197.93 (169.51-224.85)	253.48 (216.54-290.00)	404.65 (371.63-421.60)
<b>Both Sexes</b>					
14 or under	295	45.73	108.36	136.24	214.62
15 - 44	801	71.44	180.67	230.95	371.52
45 or older	796	71.81	174.54	231.38	427.73
All ages	1892	68.00 (61.92-74.07)	170.84 (158.74-181.79)	224.78 (212.91-245.98)	374.74 (336.50-431.34)

Percentile intervals (B.I.) were estimated using the percentile bootstrap method with 1,000 bootstrap replications.  
Acute Consumers only are individuals with reported fish consumption at least once during the three day reporting period.  
Source: U.S. EPA, 1996a.

Table 10-22. Per Capita Distribution of Fish (Finfish and Shellfish) Intake (g/day)  
for Consumers Only by Age and Gender - As Consumed  
(Marine)

Age	Sample Size	Mean (90% C.I.)	90th % (90% B.I.)	95th % (90% B.I.)	99th % (90% B.I.)
<b>Females</b>					
14 or under	315	69.04	114.23	162.37	336.59
15 - 44	774	76.53	149.78	178.74	271.06
45 or older	715	85.24	167.11	218.35	264.8
All ages	1804	78.47 (74.43-82.51)	155.38 (147.00-166.64)	195.15 (179.12-212.07)	279.79 (263.48-336.17)
<b>Males</b>					
14 or under	348	78.44	160.97	190.68	336.98
15 - 44	565	104.57	191.29	227.56	316.69
45 or older	467	101.46	188.77	259.85	333.18
All ages	1380	98.59 (93.16-104.03)	184.53 (173.46-194.13)	224.89 (210.00-250.28)	328.18 (310.42-348.49)
<b>Both Sexes</b>					
14 or under	663	73.62	153.2	176.9	337.24
15 - 44	1339	89.93	171.88	209.17	308.06
45 or older	1182	92.19	178.33	223.82	314.44
All ages	3184	87.77 (83.74-91.80)	169.39 (167.00-173.65)	209.50 (198.11-221.73)	320.41 (292.80-341.88)

Percentile intervals (B.I.) were estimated using the percentile bootstrap method with 1,000 bootstrap replications.  
Acute Consumers only are individuals with reported fish consumption at least once during the three day reporting period.  
Source: U.S. EPA, 1996a.



Chapter 10 - Intake of Fish and Shellfish

Table 10-23. Per Capita Distribution of Fish (Finfish and Shellfish) Intake (g/day)  
for Consumers Only by Age and Gender - As Consumed  
(All Fish)

Age	Sample Size	Mean (90% C.I.)	90th % (90% B.I.)	95th % (90% B.I.)	99th % (90% B.I.)
<b>Females</b>					
14 or under	378	69.54	126.22	165.27	338.04
15 - 44	952	88.8	170.01	212.56	361.04
45 or older	879	96.47	184.42	226.25	310.12
All ages	2209	88.47 (83.98-92.97)	170.10 (166.63-173.88)	220.56 (201.97-236.00)	340.71 (289.17-368.51)
<b>Males</b>					
14 or under	429	79.72	161.62	190	308.59
15 - 44	702	124.78	230.77	296.66	397.7
45 or older	587	119.44	224.82	262.43	434.28
All ages	1718	114.18 (108.79-119.56)	219.96 (209.17-229.91)	272.49 (254.99-301.51)	411.68 (371.43-447.85)
<b>Both Sexes</b>					
14 or under	807	74.8	153.7	178.08	337.46
15 - 44	1654	106.06	203.33	271.66	372.77
45 or older	1466	106.62	209.34	254.69	407.14
All ages	3927	100.63 (96.66-104.60)	197.44 (188.74-205.12)	253.38 (231.51-264.45)	371.59 (359.29-401.61)

Percentile intervals (B.I.) were estimated using the percentile bootstrap method with 1,000 bootstrap replications.  
Acute Consumers only are individuals with reported fish consumption at least once during the three day reporting period.  
Source: U.S. EPA, 1996a.

Table 10-24. Per Capita Distribution of Fish (Finfish and Shellfish) Intake (g/day)  
for Consumers Only Aged 18 Years and Older by Habitat - As Consumed

Habitat	Statistic	Estimate	90% Interval	
			Lower Bound	Upper Bound
Fresh/Estuarine n = 1,541 N = 37,166,000	Mean	70.91	64.16	77.65
	50th %	42.45	37.24	46.91
	90th %	176.58	165.08	193.26
	95th %	230.41	224.00	255.55
	99th %	402.56	358.58	518.41
Marine n = 2,432 N = 57,830,000	Mean	91.49	87.35	95.64
	50th %	77.56	74.89	78.52
	90th %	172.29	168.00	182.00
	95th %	215.62	201.99	225.63
	99th %	313.05	292.80	324.81
All Fish n = 3,007 N = 70,949,000	Mean	106.39	102.37	110.41
	50th %	85.36	84.00	87.36
	90th %	206.76	197.84	213.00
	95th %	258.22	241.00	266.86
	99th %	399.26	336.50	423.56

Percentile intervals were estimated using the percentile bootstrap method with 1,000 bootstrap replications.  
Note: Consumers only are individuals who consumed fish at least once during the 3-day reporting period; n = sample size; N = population size.  
Estimates are projected from a sample of consumers only 18 years of age and older to the population of consumers only 18 years of age and older using 3-year combined survey weights. The population for this survey consisted of individuals in the 48 conterminous states.  
Source: U.S. EPA, 1996a.



Table 10-25. Per Capita Distribution of Fish (Finfish and Shellfish) Intake (mg/kg-day)  
for Consumers Only by Age and Gender - As Consumed  
(Freshwater and Estuarine)

Age	Sample Size	Mean (90% C.I.)	90th % (90% B.I.)	95th % (90% B.I.)	99th % (90% B.I.)
<b>Females</b>	0	0	0	0	0
14 or under	138	1639.20	3915.56	6271.09	10113.24
15 - 44	445	961.58	2578.81	3403.75	6167.24
45 or older	453	927.85	2229.97	2894.18	4338.36
All ages	1036	1037.29 (905.50-1169.09)	2582.5 (2248.8-2734.5)	3434.16 (2927.72-3979.82)	6923.5 (4757.8-9134.9)
<b>Males</b>	0	0	0	0	0
14 or under	157	1798.24	3759.29	3952.99	7907.38
15 - 44	356	1004.96	2744.61	3348.86	4569.62
45 or older	343	992.11	2448.54	3281.38	5716.41
All ages	856	1117.74 (1011.55-1223.94)	2789.95 (2526.87-3132.65)	3399.26 (3256.87-3907.77)	5259.97 (4834.34-6593.97)
<b>Both Sexes</b>	0	0	0	0	0
14 or under	295	1721.99	3760.67	4208.18	9789.49
15 - 44	801	983.19	2616.63	3360.85	5089.78
45 or older	796	958.20	2394.21	3121.09	5157.95
All ages	1892	1076.80 (980.00-1173.61)	2695.81 (2546.77-2819.33)	3399.46 (3132.65-3839.47)	6526.10 (5270.61-6931.61)

Percentile intervals (B.I.) were estimated using the percentile bootstrap method with 1,000 bootstrap replications.  
Consumers only are individuals with reported fish consumption at least once during the three day reporting period.  
Source: U.S. EPA, 1996a.

Table 10-26. Per Capita Distribution of Fish (Finfish and Shellfish) Intake (mg/kg-day)  
for Consumers Only by Age and Gender - As Consumed  
(Marine)

Age	Sample Size	Mean (90% C.I.)	90th % (90% B.I.)	95th % (90% B.I.)	99th % (90% B.I.)
<b>Females</b>					
14 or under	315	2591.57	5074.80	6504.67	9970.44
15 - 44	774	1227.41	2469.67	3007.98	4800.68
45 or older	715	1293.99	2642.60	3565.34	4237.73
All ages	1804	1486.90 (1400.58-1573.23)	2992.38 (2841.13-3303.96)	3961.24 (3768.48-4192.13)	6521.73 (5792.54-7794.41)
<b>Males</b>					
14 or under	348	2471.15	4852.33	5860.72	8495.57
15 - 44	565	1302.62	2390.20	2882.91	3887.23
45 or older	467	1242.49	2251.43	2877.73	4016.80
All ages	1380	1505.19 (1411.84-1598.55)	2899.23 (2797.30-3199.05)	3836.02 (3563.32-4581.61)	5859.85 (5247.79-7895.62)
<b>Both Sexes</b>					
14 or under	663	2532.95	5068.69	6376.47	8749.02
15 - 44	1339	1263.35	2464.80	2961.92	4251.47
45 or older	1182	1271.92	2461.37	3383.46	4220.78
All ages	3184	1495.37 (1422.63-1568.12)	2956.38 (2838.46-3083.70)	3887.52 (3770.65-4113.22)	6510.73 (5772.57-6852.01)

Percentile intervals (B.I.) were estimated using the percentile bootstrap method with 1,000 bootstrap replications.  
Consumers only are individuals with reported fish consumption at least once during the three day reporting period.  
Source: U.S. EPA, 1996a.



Chapter 10 - Intake of Fish and Shellfish

Table 10-27. Per Capita Distribution of Fish (Finfish and Shellfish) Intake (mg/kg-day)  
for Consumer Only by Age and Gender - As Consumed  
(All Fish)

Age	Sample Size	Mean (90% C.I.)	90th % (90% B.I.)	95th % (90% B.I.)	99th % (90% B.I.)
<b>Females</b>					
14 or under	378	2683.51	5299.68	7160.73	12473.65
15 - 44	952	1414.54	2726.46	3740.83	6703.25
45 or older	879	1449.43	2838.76	3736.61	4693.94
All ages	2209	1637.08 (1546.08-1728.08)	3122.82 (2992.63-3308.93)	4312.16 (3969.22-4710.75)	7163.38 (6852.67-7794.41)
<b>Males</b>					
14 or under	429	2568.93	4714.97	5818.08	9350.89
15 - 44	702	1545.93	2854.49	3773.51	5254.04
45 or older	587	1451.06	2841.35	3366.84	5091.31
All ages	1718	1715.79 (1636.68-1794.90)	3399.26 (3290.97-3766.18)	4244.32 (4015.03-4581.61)	6818.35 (5792.54-7588.15)
<b>Both Sexes</b>					
14 or under	807	2624.35	5020.14	6904.83	10384.82
15 - 44	1654	1477.57	2798.37	3747.88	5386.43
45 or older	1466	1450.15	2839.04	3515.81	4922.99
All ages	3927	1674.31 (1606.79-1741.83)	3299.54 (3133.69-3462.35)	4258.69 (4065.32-4483.83)	7126.90 (6644.11-7794.41)

Percentile intervals (B.I.) were estimated using the percentile bootstrap method with 1,000 bootstrap replications.  
Consumers only are individuals with reported fish consumption at least once during the three day reporting period.  
Source: U.S. EPA, 1996a.

Table 10-28. Per Capita Distribution of Fish (Finfish and Shellfish) Intake (mg/kg-day)  
for Consumers Only Aged 18 Years and Older by Habitat - As Consumed

Milligrams/kilogram/person/day

Habitat	Statistic	Estimate	90% Interval	
			Lower Bound	Upper Bound
Fresh/Estuarine n = 1,541 N = 37,166,000	Mean	959.15	867.58	1,050.72
	50th %	601.88	532.31	656.86
	90th %	2,442.97	2,233.16	2,606.66
	95th %	3,116.28	2,839.90	3,303.96
	99th %	5,151.98	4,432.30	6,931.61
Marine n = 2,432 N = 57,830,000	Mean	1,270.78	1,214.65	1,326.90
	50th %	1,062.93	1,019.60	1,087.06
	90th %	2,467.68	2,331.88	2,585.09
	95th %	3,116.74	2,906.16	3,264.98
	99th %	4,250.22	4,037.74	4,387.96
All Fish n = 3,007 N = 70,949,000	Mean	1,461.71	1,406.34	1,517.09
	50th %	1,189.29	1,156.77	1,225.43
	90th %	2,802.28	2,685.81	2,868.73
	95th %	3,588.11	3,308.93	3,798.54
	99th %	5,355.90	5,095.58	5,766.99

Percentile intervals were estimated using the percentile bootstrap method with 1,000 bootstrap replications.  
Note: Consumers only are individuals who consumed fish at least once during the 3-day reporting period; n = sample size; N = population size  
Estimates are projected from a sample of consumers only 18 years of age and older to the population of consumers only 18 years of age and older using 3-year combined survey weights. The population for this survey consisted of individuals in the 48 conterminous states.  
Source: U.S. EPA, 1996a.



Table 10-29. Per Capita Distribution of Fish (Finfish and Shellfish) Intake (g/day) for the U.S. Population by Age and Gender - Uncooked Fish Weight (Freshwater and Estuarine)

Age	Sample Size	Mean (90% C.I.)	90th % (90% B.I.)	95th % (90% B.I.)	99th % (90% B.I.)
<b>Females</b>					
14 or under	1431	1.99 (1.34-2.64)	1.81 (0.00-4.63)	15.88 (7.89-18.38)	46.82 (36.72-54.55)
15 - 44	2891	5.50 (4.53-6.48)	13.62 (9.99-18.11)	36.68 (32.53-40.31)	94.93 (75.74-114.34)
45 or older	2340	6.65 (5.30-8.00)	24.18 (18.11-27.41)	46.91 (37.94-52.92)	108.90 (92.06-123.72)
All ages	6662	5.13 (4.37-5.88)	13.31 (10.48-16.67)	35.63 (28.92-40.07)	94.61 (77.70-109.09)
<b>Males</b>					
14 or under	1546	2.69 (1.62-3.76)	1.07 (0.33-8.67)	18.47 (14.39-25.91)	57.07 (47.32-65.37)
15 - 44	2151	7.87 (6.46-9.29)	22.10 (13.43-31.80)	63.26 (50.62-70.12)	126.61 (108.54-162.80)
45 or older	1553	8.87 (7.32-10.43)	28.74 (24.23-33.07)	61.15 (52.57-71.59)	125.90 (112.28-147.62)
All ages	5250	6.91 (6.07-7.75)	19.00 (14.99-23.69)	51.43 (47.32-54.82)	112.11 (108.54-127.19)
<b>Both Sexes</b>					
14 or under	2977	2.35 (1.70-3.00)	1.72 (0.00-5.00)	17.46 (12.78-18.68)	50.14 (43.58-55.00)
15 - 44	5042	6.64 (5.71-7.56)	18.30 (14.99-21.14)	47.31 (36.22-59.65)	109.66 (94.43-127.19)
45 or older	3893	7.66 (6.50-8.81)	26.11 (21.95-28.85)	52.92 (45.73-61.51)	113.10 (107.18-133.74)
All ages	11912	5.98(5.29-6.67)	15.89(14.39-17.76)	40.03(37.94-44.75)	107.63(98.25-109.09)

Percentile intervals (B.I.) were estimated using the percentile bootstrap method with 1,000 bootstrap replications.  
Source: U.S. EPA, 1996a.

Table 10-30. Per Capita Distribution of Fish (Finfish and Shellfish) Intake (g/day) for the U.S. Population by Age and Gender - Uncooked Fish Weight (Marine)

Age	Sample Size	Mean (90% C.I.)	90th % (90% B.I.)	95th % (90% B.I.)	99th % (90% B.I.)
<b>Females</b>					
14 or under	1431	8.61 (6.67-10.56)	31.23 (26.85-37.29)	49.75 (41.46-57.49)	104.26 (83.35-140.07)
15 - 44	2891	12.84 (11.51-14.18)	46.66 (38.35-54.30)	72.16 (63.12-77.18)	133.69 (121.33-142.82)
45 or older	2340	16.26 (14.68-17.84)	56.01 (50.00-61.97)	84.71 (75.05-93.29)	131.43 (112.07-156.01)
All ages	6662	13.05 (11.97-14.12)	46.70 (44.49-49.72)	72.22 (65.55-75.47)	130.73 (121.33-137.18)
<b>Males</b>					
14 or under	1546	9.40 (7.36-11.45)	31.32 (25.20-44.12)	65.37 (54.60-73.39)	118.42 (82.34-176.52)
15 - 44	2151	17.11 (15.31-18.90)	66.06 (62.21-73.20)	93.32 (81.26-106.67)	155.16 (136.77-181.18)
45 or older	1553	17.22 (15.19-19.25)	62.64 (59.39-68.44)	84.96 (79.93-99.44)	146.78 (142.58-185.44)
All ages	5250	15.27 (13.86-16.68)	61.12 (56.59-63.09)	81.89 (77.91-87.16)	147.09 (134.55-174.31)
<b>Both Sexes</b>					
14 or under	2977	9.02 (7.28-10.75)	31.52 (30.19-35.75)	56.35 (50.22-62.25)	117.75 (91.82-140.07)
15 - 44	5042	14.88 (13.57-16.19)	55.99 (53.04-61.33)	80.70 (75.19-87.16)	138.23 (128.40-157.23)
45 or older	3893	16.69 (15.34-18.04)	59.12 (52.84-64.53)	84.92 (76.67-93.32)	142.92 (134.55-155.13)
All ages	11912	14.11(13.07-15.14)	52.10(47.83-55.93)	76.51(74.58-80.89)	138.22(132.98-155.13)

Percentile intervals (B.I.) were estimated using the percentile bootstrap method with 1,000 bootstrap replications.  
Source: U.S. EPA, 1996a.



Chapter 10 - Intake of Fish and Shellfish

Age	Sample Size	Mean (90% C.I.)	90th % (90% B.I.)	95th % (90% B.I.)	99th % (90% B.I.)
<b>Females</b>					
14 or under	1431	10.60 (8.40-12.81)	41.10 (35.80-47.57)	56.16 (49.78-65.55)	130.78 (83.35-160.66)
15 - 44	2891	18.35 (16.67-20.02)	62.21 (54.47-73.56)	93.13 (82.29-108.03)	155.75 (137.18-174.31)
45 or older	2340	22.91 (20.78-25.04)	74.56 (65.37-79.67)	107.66 (97.64-111.71)	159.97 (157.17-173.74)
All ages	6662	18.17 (16.82-19.53)	61.08 (56.94-63.12)	92.03 (86.94-96.11)	157.08 (147.34-168.83)
<b>Males</b>					
14 or under	1546	12.09 (9.70-14.49)	45.59 (34.69-53.11)	68.18 (64.28-79.90)	127.20 (87.29-176.52)
15 - 44	2151	24.98 (22.79-27.17)	87.15 (80.89-94.63)	122.29 (111.05-124.83)	197.15 (179.86-198.87)
45 or older	1553	26.09 (23.52-28.67)	81.76 (76.67-88.03)	112.33 (109.65-130.36)	211.20 (190.74-223.72)
All ages	5250	22.18 (20.52-23.83)	76.13 (74.22-79.92)	110.88 (108.54-118.56)	180.90 (174.39-198.87)
<b>Both Sexes</b>					
14 or under	2977	11.36 (9.49-13.24)	43.00 (34.69-47.32)	65.34 (56.28-68.51)	130.41 (107.12-160.66)
15 - 44	5042	21.51 (19.97-23.06)	75.15 (73.56-79.71)	109.57 (106.72-117.47)	175.73 (162.80-198.63)
45 or older	3893	24.35 (22.46-26.24)	77.57 (72.07-84.02)	110.13 (100.42-119.87)	180.74 (164.76-210.75)
All ages	11912	20.08(18.82-21.35)	70.11 (65.37-74.20)	102.01 (99.26-106.67)	173.18 (162.80-176.52)

Percentile intervals (B.I.) were estimated using the percentile bootstrap method with 1,000 bootstrap replications.  
Source: U.S. EPA, 1996a.

Habitat	Statistic	Estimate	90% Interval	
			Lower Bound	Upper Bound
Fresh/Estuarine	Mean	7.09	6.22	7.96
	50th %	0.00	0.00	0.00
	90th %	21.72	18.52	25.82
	95th %	49.89	47.32	54.67
	99th %	111.13	107.18	116.38
Marine	Mean	16.01	14.89	17.12
	50th %	0.00	0.00	0.00
	90th %	59.35	56.59	61.49
	95th %	82.95	80.37	88.36
	99th %	142.78	131.02	156.89
All Fish	Mean	23.10	21.62	24.58
	50th %	0.00	0.00	0.00
	90th %	76.84	74.37	80.13
	95th %	110.28	106.67	115.32
	99th %	177.44	171.73	198.63

Percentile intervals were estimated using the percentile bootstrap method with 1,000 bootstrap replications.  
NOTE: Estimates are projected from a sample of 8,478 individuals of age 18 and older to the U.S. population of 177,807,000 individuals of age 18 and older using 3-year combined survey weights.  
Source: U.S. EPA, 1996a.



Table 10-33. Per Capita Distribution of Fish (Finfish and Shellfish) Intake (mg/kg-day)  
for the U.S. Population by Age and Gender - Uncooked Fish Weight  
(Freshwater and Estuarine)

Age	Sample Size	Mean (90% C.I.)	90th % (90% B.I.)	95th % (90% B.I.)	99th % (90% B.I.)
<b>Females</b>					
14 or under	1431	84.78 (58.06-111.50)	70.75 (0.00-143.13)	599.06 (266.71-722.58)	1713.06 (1511.78-2313.50)
15 - 44	2891	85.15 (70.68-99.62)	202.83 (153.48-259.97)	584.79 (538.05-631.86)	1411.42 (1236.72-1659.15)
45 or older	2340	98.97 (79.89-118.04)	333.38 (269.96-379.98)	733.74 (606.36-820.68)	1561.40 (1331.46-1667.88)
All ages	6662	89.54 (76.51-102.58)	225.51 (176.38-280.11)	625.30 (552.99-713.85)	1558.08 (1394.99-1659.15)
<b>Males</b>					
14 or under	1546	91.62 (55.18-128.05)	38.98 (12.26-281.50)	868.97 (485.33-1063.50)	1642.60 (1599.78-1693.88)
15 - 44	2151	96.91 (78.91-114.90)	281.17 (165.37-387.46)	740.91 (546.79-850.52)	1589.97 (1353.43-1992.23)
45 or older	1553	107.87 (88.47-127.28)	361.99 (304.96-455.29)	702.35 (628.25-810.62)	1612.49 (1344.07-1848.39)
All ages	5250	98.86 (87.19-110.52)	292.58 (217.42-342.11)	755.53 (677.47-790.85)	1596.61 (1538.89-1711.41)
<b>Both Sexes</b>					
14 or under	2977	88.26 (66.69-109.83)	66.00 (0.00-143.13)	717.37 (485.60-880.64)	1688.55 (1511.78-1824.44)
15 - 44	5042	90.77 (78.37-103.16)	250.26 (194.04-289.19)	631.31 (538.05-773.91)	1529.94 (1352.50-1659.15)
45 or older	3893	103.00 (87.86-118.15)	345.69 (291.80-423.39)	719.81 (637.94-790.85)	1590.13 (1373.97-1668.93)
All ages	11912	93.99 (83.41-104.57)	251.82 (222.54-282.58)	677.66 (631.86-729.11)	1593.28 (1511.78-1659.15)

Percentile intervals (B.I.) were estimated using the percentile bootstrap method with 1,000 bootstrap replications.  
Source: U.S. EPA, 1996a.

Table 10-34. Per Capita Distribution of Fish (Finfish and Shellfish) Intake (mg/kg-day)  
for the U.S. Population by Age and Gender - Uncooked Fish Weight  
(Marine)

Age	Sample Size	Mean (90% C.I.)	90th % (90% B.I.)	95th % (90% B.I.)	99th % (90% B.I.)
<b>Females</b>					
14 or under	1431	333.99 (267.25-400.72)	1132.99 (864.83-1407.24)	1959.91 (1780.61-2347.02)	3776.60 (3173.86-5736.90)
15 - 44	2891	206.03 (183.95-228.11)	762.54 (617.86-857.55)	1137.58 (1036.38-1211.86)	2174.21 (2014.41-2393.16)
45 or older	2340	246.73 (221.45-272.00)	829.52 (777.87-944.26)	1236.00 (1174.14-1413.34)	2161.65 (1952.51-2303.80)
All ages	6662	246.47 (223.28-269.66)	847.60 (811.19-893.29)	1305.49 (1215.53-1385.66)	2615.85 (2365.65-2857.62)
<b>Males</b>					
14 or under	1546	296.99 (241.85-352.13)	1089.46 (1003.46-1256.97)	1907.65 (1685.30-2186.58)	3723.81 (3274.93-4574.13)
15 - 44	2151	212.88 (190.31-235.44)	800.79 (741.29-859.61)	1191.75 (1096.61-1245.94)	1890.42 (1685.30-1969.63)
45 or older	1553	212.15 (187.25-237.04)	792.86 (747.56-890.31)	1100.20 (1039.02-1210.66)	1842.38 (1749.67-2219.32)
All ages	5250	233.07 (209.65-256.49)	859.01 (798.27-907.76)	1255.35 (1204.46-1382.05)	2520.94 (2263.58-2733.15)
<b>Both Sexes</b>					
14 or under	2977	315.12 (260.95-369.29)	1123.28 (993.12-1371.24)	1909.37 (1785.09-2062.64)	3820.21 (3370.59-4574.13)
15 - 44	5042	209.30 (190.68-227.92)	780.16 (722.86-843.41)	1174.69 (1104.42-1215.53)	2019.59 (1918.45-2237.22)
45 or older	3893	231.06 (212.18-249.95)	813.12 (747.56-907.76)	1193.22 (1076.85-1333.72)	2029.16 (1863.17-2219.32)
All ages	11912	240.07 (220.14-260.01)	855.63 (809.67-909.76)	1271.54 (1227.16-1371.24)	2575.29 (2393.16-2708.59)

Percentile intervals (B.I.) were estimated using the percentile bootstrap method with 1,000 bootstrap replications.  
Source: U.S. EPA, 1996a.



Chapter 10 - Intake of Fish and Shellfish

Table 10-35. Per Capita Distribution of Fish (Finfish and Shellfish) Intake (mg/kg-day)  
for the U.S. Population by Age and Gender - Uncooked Fish Weight  
(All Fish)

Age	Sample Size	Mean (90% C.I.)	90th % (90% B.I.)	95th % (90% B.I.)	99th % (90% B.I.)
<b>Females</b>					
14 or under	1431	418.76 (339.58-497.95)	1389.10 (1150.77-1785.09)	2341.90 (2062.64-2860.52)	4985.96 (3971.54-5736.90)
15 - 44	2891	291.18 (263.86-318.50)	993.92 (854.63-1127.32)	1436.00 (1234.66-1631.25)	2726.50 (2406.11-3044.81)
45 or older	2340	345.69 (312.49-378.90)	1122.26 (1050.15-1230.68)	1669.72 (1556.83-1784.37)	2684.71 (2303.80-3064.38)
All ages	6662	336.01 (307.83-364.20)	1120.91 (1054.05-1172.38)	1720.84 (1642.63-1855.69)	3093.76 (2973.66-3265.54)
<b>Males</b>					
14 or under	1546	388.61 (320.66-456.56)	1476.31 (1371.24-1632.55)	2038.58 (1909.00-2631.42)	4294.12 (3556.31-4574.13)
15 - 44	2151	309.78 (281.55-338.02)	1096.57 (1044.57-1194.06)	1566.39 (1410.20-1609.35)	2275.15 (2047.18-2465.77)
45 or older	1553	320.02 (287.79-352.25)	1013.05 (955.37-1096.43)	1459.73 (1340.97-1601.79)	2392.05 (2233.16-2806.51)
All ages	5250	331.93 (306.46-357.40)	1126.66 (1081.06-1225.66)	1621.80 (1599.78-1696.20)	3031.31 (2806.51-3274.93)
<b>Both Sexes</b>					
14 or under	2977	403.38 (343.65-463.12)	1442.72 (1279.82-1672.75)	2191.90 (2021.16-2536.75)	4425.27 (4000.27-4669.59)
15 - 44	5042	300.06 (277.94-322.19)	1040.98 (1003.55-1097.08)	1514.82 (1421.34-1572.40)	2481.23 (2383.54-2773.15)
45 or older	3893	334.07 (307.87-360.26)	1069.14 (978.95-1140.98)	1579.43 (1373.97-1696.20)	2653.45 (2292.45-2806.51)
All ages	11912	334.06 (311.25-356.88)	1123.14 (1090.76-1178.95)	1684.23 (1620.48-1718.51)	3092.77 (2973.66-3250.20)

Percentile intervals (B.I.) were estimated using the percentile bootstrap method with 1,000 bootstrap replications.  
Source: U.S. EPA, 1996a.

Table 10-36. Per Capita Distribution of Fish (Finfish and Shellfish) Intake (mg/kg-day)  
for the U.S. Population Aged 18 Years and Older by Habitat - Uncooked Fish Weight

Habitat	Statistic	Estimate	90% Interval	
			Lower Bound	Upper Bound
Fresh/Estuarine	Mean	95.99	84.30	107.69
	50th %	0.00	0.00	0.00
	90th %	306.74	259.97	334.58
	95th %	677.39	626.01	734.34
	99th %	1,547.81	1,411.56	1,599.78
Marine	Mean	222.86	207.34	238.37
	50th %	0.00	0.00	0.00
	90th %	810.43	778.50	859.61
	95th %	1,190.45	1,145.61	1,219.60
	99th %	2,033.92	1,870.09	2,263.58
All Fish	Mean	318.85	298.20	339.49
	50th %	0.00	0.00	0.00
	90th %	1,061.14	1,016.87	1,105.01
	95th %	1,548.77	1,464.72	1,609.14
	99th %	2,559.07	2,444.24	2,764.50

Percentile intervals were estimated using the percentile bootstrap method with 1,000 bootstrap replications.  
NOTE: Estimates are projected from a sample of 8,478 individuals of age 18 and older to the population of 177,807,000 individuals of age 18 and older using 3-year combined survey weights.  
Source: U.S. EPA, 1996a.





Table 10-37. Per Capita Distribution of Fish (Finfish and Shellfish) Intake (g/day)  
for Consumers Only by Age and Gender - Uncooked Fish Weight  
(Freshwater and Estuarine)

Age	Sample Size	Mean (90% C.I.)	90th % (90% B.I.)	95th % (90% B.I.)	99th % (90% B.I.)
<b>Females</b>					
14 or under	138	48.3	117.27	161.44	230.63
15 - 44	445	78.56	191.95	242.76	472.21
45 or older	453	78.77	192.32	258.56	368.84
All ages	1036	74.67 (65.46-83.88)	181.08 (171.19-197.59)	239.59 (220.69-284.70)	409.00 (345.96-671.54)
<b>Males</b>					
14 or under	157	64.91	141.35	193.79	287.28
15 - 44	356	104.86	269.96	343.66	494.38
45 or older	343	102.56	234.28	326.96	539.77
All ages	856	98.12 (88.60-107.64)	246.93 (212.93-283.90)	324.53 (283.28-381.58)	499.19 (488.41-532.32)
<b>Both Sexes</b>					
14 or under	295	56.95	134.89	166.32	262.87
15 - 44	801	91.66	237.27	322.06	494.64
45 or older	796	90	220.76	295.41	523.94
All ages	1892	86.19 (78.41-93.97)	217.92 (205.28-237.27)	290.04 (267.10-325.61)	489.29 (424.87-534.20)

Percentile intervals (B.I.) were estimated using the percentile bootstrap method with 1,000 bootstrap replications.  
Consumers only are individuals reported fish consumption at least once during the three day reporting period.  
Source: U.S. EPA, 1996a.

Table 10-38. Per Capita Distribution of Fish (Finfish and Shellfish) Intake (g/day)  
for Consumers Only by Age and Gender - Uncooked Fish Weight  
(Marine)

Age	Sample Size	Mean (90% C.I.)	90th % (90% B.I.)	95th % (90% B.I.)	99th % (90% B.I.)
<b>Females</b>					
14 or under	315	89.92	169.23	198.62	432.51
15 - 44	774	98.53	194.59	231.22	317.42
45 or older	715	110	214.73	279.67	345.37
All ages	1804	101.30 (95.90-106.69)	195.37 (186.67-213.33)	252.43 (231.53-278.16)	372.17 (314.67-428.00)
<b>Males</b>					
14 or under	348	101.5	205.49	242.28	408.68
15 - 44	565	133.86	244.46	297.67	393.14
45 or older	467	131.2	243.33	327.14	428.72
All ages	1380	126.85 (119.75-133.94)	238.64 (225.57-247.01)	296.68 (279.95-316.81)	425.98 (403.66-481.95)
<b>Both Sexes</b>					
14 or under	663	95.56	189.32	231.72	442.87
15 - 44	1339	115.41	223.99	263.76	383.16
45 or older	1182	119.08	226.55	288.16	418.23
All ages	3184	113.11 (107.79-118.43)	222.67 (216.50-225.56)	271.70 (260.62-279.95)	415.88 (367.26-440.45)

Percentile intervals (B.I.) were estimated using the percentile bootstrap method with 1,000 bootstrap replications.  
Consumers only are individuals with reported fish consumption at least once during the three day reporting period.  
Source: U.S. EPA, 1996a.



Chapter 10 - Intake of Fish and Shellfish

Table 10-39. Per Capita Distribution of Fish (Finfish and Shellfish) Intake (g/day)  
for Consumers Only by Age and Gender - Uncooked Fish Weight  
(All Fish)

Age	Sample Size	Mean (90% C.I.)	90th % (90% B.I.)	95th % (90% B.I.)	99th % (90% B.I.)
<b>Females</b>					
14 or under	378	89.73	163.47	204.14	476.56
15 - 44	952	114.04	220.63	277.69	461.54
45 or older	879	123.61	236.3	298.66	397.43
All ages	2209	113.58 (107.69-119.47)	220.44 (206.27-226.80)	287.08 (257.09-312.42)	448.57 (393.68-531.63)
<b>Males</b>					
14 or under	429	102.01	205.25	244.46	386.47
15 - 44	702	160.06	305.61	379.38	495.51
45 or older	587	152.52	292.95	350.26	555.11
All ages	1718	146.18 (138.99-153.38)	283.46 (261.72-297.95)	350.99 (328.70-382.33)	520.51 (488.41-591.47)
<b>Both Sexes</b>					
14 or under	807	96.07	195.35	232.85	466.09
15 - 44	1654	136.12	262.15	343.86	488.9
45 or older	1466	136.38	263.95	326.94	510.25
All ages	3927	129.00 (123.74-134.27)	249.09 (240.99-264.10)	326.00 (306.02-335.58)	497.54 (469.23-519.67)

Percentile intervals (B.I.) were estimated using the percentile bootstrap method with 1,000 bootstrap replications.  
Consumers only are individuals reported fish consumption at least once during the three day reporting period.  
Source: U.S. EPA, 1996a.

Table 10-40. Per Capita Distribution of Fish (Finfish and Shellfish) Intake (g/day)  
for Consumers Only Aged 18 Years and Older by Habitat - Uncooked Fish Weight

Habitat	Statistic	Estimate	90% Interval	
			Lower Bound	Upper Bound
Fresh/Estuarine n = 1,541 N = 37,166,000	Mean	89.88	81.41	98.35
	50th %	53.64	46.44	57.81
	90th %	223.11	206.58	237.27
	95th %	296.89	283.90	325.61
	99th %	502.93	448.23	654.55
Marine n = 2,432 N = 57,830,000	Mean	117.83	112.47	123.20
	50th %	98.79	95.69	100.76
	90th %	225.51	222.67	234.00
	95th %	279.50	261.47	289.44
	99th %	403.48	369.10	427.73
All Fish n = 3,007 N = 70,949,000	Mean	136.33	131.11	141.55
	50th %	111.50	108.53	112.00
	90th %	262.03	253.24	272.71
	95th %	328.66	323.61	340.52
	99th %	506.02	435.44	531.63

Percentile intervals (B.I.) were estimated using the percentile bootstrap method with 1,000 bootstrap replications.  
Note: Consumers only are individuals who consumed fish at least once during the 3-day reporting period; n = sample size; and N = population size.  
Estimates are projected from a sample of consumers only 18 years of age and older to the population of consumers only 18 years of age and older using 3-year combined survey weights. The population for this survey consisted of individuals in the 48 conterminous states.  
Source: U.S. EPA, 1996a.



Table 10-41. Per Capita Distribution of Fish (Finfish and Shellfish) Intake (mg/kg-day)  
for Consumers Only by Age and Gender - Uncooked Fish Weight  
(Freshwater and Estuarine)

Age	Sample Size	Mean (90% C.I.)	90th % (90% B.I.)	95th % (90% B.I.)	99th % (90% B.I.)
<b>Females</b>					
14 or under	138	2070.41	4450.54	6915.31	13269.61
15 - 44	445	1229.97	3045.41	4191.25	7711.43
45 or older	453	1171.17	2886.48	3519.87	5577.34
All ages	1036	1317.18 (1150.10-1484.26)	3250.31 (2988.81-3491.38)	4240.89 (3710.16-5025.02)	8912.52 (6385.55-11533.98)
<b>Males</b>					
14 or under	157	2229.31	4638.34	5071.41	9622.15
15 - 44	356	1294.27	3318.89	4275.83	5974.96
45 or older	343	1235.55	2898.00	4097.24	7217.68
All ages	856	1411.35 (1278.61-1544.08)	3579.06 (3225.84-4060.30)	4615.66 (4121.91-5081.65)	6594.61 (5980.19-7944.55)
<b>Both Sexes</b>					
14 or under	295	2153.11	4634.82	5756.93	12388.27
15 - 44	801	1261.99	3276.06	4246.63	6625.15
45 or older	796	1201.57	2892.52	3981.84	6378.11
All ages	1892	1363.44 (1242.24-1484.65)	3325.14 (3232.58-3676.99)	4408.18 (4085.55-4781.34)	7957.50 (6979.20-8920.99)

Percentile intervals (B.I.) were estimated using the percentile bootstrap method with 1,000 bootstrap replications.  
Consumers only are individuals with reported fish consumption at least once during the three day reporting period.  
Source: U.S. EPA, 1996a.

Table 10-42. Per Capita Distribution of Fish (Finfish and Shellfish) Intake (mg/kg-day)  
for Consumers Only by Age and Gender - Uncooked Fish Weight  
(Marine)

Age	Sample Size	Mean (90% C.I.)	90th % (90% B.I.)	95th % (90% B.I.)	99th % (90% B.I.)
<b>Females</b>					
	0	0	0	0	0
14 or under	315	3359.10	6058.97	8573.62	13050.09
15 - 44	774	1582.77	3129.41	3854.14	5961.80
45 or older	715	1669.73	3429.24	4397.07	5476.02
All ages	1804	1920.77 (1804.28-2037.26)	3793.20 (3618.55-4328.00)	5083.63 (4953.40-5552.65)	8576.60 (7527.83-9743.01)
<b>Males</b>					
	0	0	0	0	0
14 or under	348	3180.45	6434.20	8089.26	10764.01
15 - 44	565	1666.42	3102.24	3651.10	4998.14
45 or older	467	1604.71	2931.17	3725.63	5373.82
All ages	1380	1934.12 (1812.97-2055.28)	3736.16 (3548.08-4072.42)	4884.60 (4454.15-5710.83)	8066.96 (6852.67-9869.52)
<b>Both Sexes</b>					
	0	0	0	0	0
14 or under	663	3272.13	6278.74	8424.77	11838.54
15 - 44	1339	1622.75	3120.60	3682.17	5517.95
45 or older	1182	1641.87	3320.87	4328.34	5406.76
All ages	3184	1926.95 (1829.50-2024.39)	3752.89 (3631.98-4001.16)	5018.74 (4852.08-5267.31)	8448.28 (7215.72-9136.89)

Percentile intervals (B.I.) were estimated using the percentile bootstrap method with 1,000 bootstrap replications.  
Consumers only are individuals with reported fish consumption at least once during the three day reporting period.  
Source: U.S. EPA, 1996a.



Chapter 10 - Intake of Fish and Shellfish

Table 10-43. Per Capita Distribution of Fish (Finfish and Shellfish) Intake (mg/kg-day)  
for Consumer Only by Age and Gender - Uncooked Fish Weight  
(All Fish)

Age	Sample Size	Mean (90% C.I.)	90th % (90% B.I.)	95th % (90% B.I.)	99th % (90% B.I.)
<b>Females</b>					
14 or under	378	3448.73	7100.43	9012.18	15381.13
15 - 44	952	1818.32	3506.20	4661.96	8789.33
45 or older	879	1857.64	3520.90	4740.11	6561.13
All ages	2209	2102.20 (1982.89-2221.51)	4092.51 (3842.15-4282.08)	5545.07 (5080.72-6007.28)	9630.23 (8166.44-9796.61)
<b>Males</b>					
14 or under	429	3273.63	5734.46	7570.83	11891.85
15 - 44	702	1983.16	3720.05	4769.44	6121.56
45 or older	587	1850.69	3534.61	4311.83	6374.34
All ages	1718	2193.24 (2089.20-2297.28)	4385.06 (4121.91-4776.34)	5351.38 (5055.10-5727.01)	8596.82 (7816.70-10199.24)
<b>Both Sexes</b>					
14 or under	807	3358.33	6333.46	8611.73	12406.35
15 - 44	1654	1897.40	3674.88	4709.78	7276.18
45 or older	1466	1854.57	3522.43	4615.22	6440.17
All ages	3927	2145.26 (2055.92-2234.61)	4223.91 (4085.76-4454.15)	5477.86 (5163.33-5686.04)	9171.52 (8605.35-9796.61)

Percentile intervals (B.I.) were estimated using the percentile bootstrap method with 1,000 bootstrap replications.  
Consumers only are individuals with reported fish consumption at least once during the three day reporting period.  
Source: U.S. EPA, 1996a.

Table 10-44. Per Capita Distribution of Fish (Finfish and Shellfish) Intake (mg/kg-day)  
for Consumers Only Aged 18 Years and Older by Habitat - Uncooked Fish Weight

Habitat	Statistic	Estimate	90% Interval	
			Lower Bound	Upper Bound
Fresh/Estuarine n = 1,541 N = 37,166,000	Mean	1,216.82	1,101.74	1,331.90
	50th %	740.93	639.11	822.65
	90th %	3,050.95	2,931.26	3,270.80
	95th %	4,025.44	3,639.76	4,121.91
	99th %	6,638.62	6,007.28	8,920.99
Marine n = 2,432 N = 57,830,000	Mean	1,637.10	1,564.27	1,709.92
	50th %	1,370.42	1,302.29	1,422.69
	90th %	3,169.02	3,006.55	3,328.98
	95th %	3,926.74	3,632.70	4,156.98
	99th %	5,452.75	5,353.12	5,596.31
All Fish n = 3,007 N = 70,949,000	Mean	1,873.84	1,801.93	1,945.75
	50th %	1,515.91	1,477.99	1,570.40
	90th %	3,599.04	3,443.64	3,676.99
	95th %	4,665.15	4,264.03	4,812.97
	99th %	7,022.47	6,459.64	7,294.80

Percentile intervals (B.I.) were estimated using the percentile bootstrap method with 1,000 bootstrap replications.  
Note: Consumers only are individuals who consumed fish at least once during the 3-day reporting period; n = sample size; and N = population size.  
Estimates are projected from a sample of consumers only 18 years of age and older to the population of consumers only 18 years of age and older using 3-year combined survey weights. The population for this survey consisted of individuals in the 48 conterminous states.  
Source: U.S. EPA, 1996a.



Table 10-45. Distribution of Quantity of Fish Consumed (in grams) Per Eating Occasion, by Age and Sex

Age (years)-Sex Group	Mean	SD	Percentiles						
			5th	25th	50th	75th	90th	95th	99th
1-2 Male-Female	52	38	8	28	43	58	112	125	168
3-5 Male-Female	70	51	12	36	57	85	113	170	240
6-8 Male-Female	81	58	19	40	72	112	160	170	288
9-14 Male	101	78	28	56	84	113	170	255	425
9-14 Female	86	62	19	45	79	112	168	206	288
15-18 Male	117	115	20	57	85	142	200	252	454
15-18 Female	111	102	24	56	85	130	225	270	568
19-34 Male	149	125	28	64	113	196	284	362	643
19-34 Female	104	74	20	57	85	135	184	227	394
35-64 Male	147	116	28	80	113	180	258	360	577
35-64 Female	119	98	20	57	85	152	227	280	480
65-74 Male	145	109	35	75	113	180	270	392	480
65-74 Female	123	87	24	61	103	168	227	304	448
75+ Male	124	68	36	80	106	170	227	227	336
75+ Female	112	69	20	61	112	151	196	225	360
Overall	117	98	20	57	85	152	227	284	456

Source: Pao et al., 1982.

Table 10-46. Mean Fish Intake in a Day, by Sex and Age<sup>a</sup>

Sex Age (year)	Per capita intake (g/day)	Percent of population consuming fish in 1 day	Mean intake (g/day) for consumers only <sup>b</sup>
Males or Females 5 and under	4	6.0	67
Males 6-11	3	3.7	79
12-19	3	2.2	136
20 and over	15	10.9	138
Females 6-11	7	7.1	99
12-19	9	9.0	100
20 and over	12	10.9	110
All individuals	11	9.4	117

<sup>a</sup> Based on USDA Nationwide Food Consumption Survey 1987-88 data for one day.  
<sup>b</sup> Intake for users only was calculated by dividing the per capita consumption rate by the fraction of the population consuming fish in one day.  
Source: USDA, 1992b.



Table 10-47. Percent of Respondents That Responded Yes, No, or Don't Know to Eating Seafood in 1 Month (including shellfish, eels, or squid)

Population Group	Total N	Response					
		No		Yes		DK	
		N	%	N	%	N	%
<b>Overall</b>	4663	1811	38.8	2780	59.6	72	1.5
<b>Gender</b>							
*	2	1	50.0	1	50.0	*	*
Male	2163	821	38.0	1311	60.6	31	1.4
Female	2498	989	39.6	1468	58.8	41	1.6
<b>Age (years)</b>							
*	84	25	29.8	42	50.0	17	20.2
1-4	263	160	60.8	102	38.8	1	0.4
5-11	348	177	50.9	166	47.7	5	1.4
12-17	326	179	54.9	137	42.0	10	3.1
18-64	2972	997	33.5	1946	65.5	29	1.0
>64	670	273	40.7	387	57.8	10	1.5
<b>Race</b>							
*	60	20	33.3	22	36.7	18	30.0
White	3774	1475	39.1	2249	59.6	50	1.3
Black	463	156	33.7	304	65.7	3	0.6
Asian	77	21	27.3	56	72.7	*	*
Some Others	96	39	40.6	56	58.3	1	1.0
Hispanic	193	100	51.8	93	48.2	*	*
<b>Hispanic</b>							
*	46	10	21.7	412	43.0	28	41.3
No	4243	1625	31.2	1366	67.7	21	1.2
Yes	348	165	35.4	236	62.3	9	*
DK	26	11	40.4	766	58.5	14	*
<b>Employment</b>							
*	958	518	54.1	412	43.0	28	2.9
Full Time	2017	630	31.2	1366	67.7	21	1.0
Part Time	379	134	35.4	236	62.3	9	2.4
Not Employed	1309	529	40.4	766	58.5	14	1.1
<b>Education</b>							
*	1021	550	53.9	434	42.5	37	3.6
< High School	399	196	49.1	198	49.6	45	1.3
High School Graduate	1253	501	40.0	739	59.0	13	1.0
< College	895	304	34.0	584	65.3	7	0.8
College Graduate	650	159	24.5	484	74.5	7	1.1
Post Graduate	445	101	22.7	341	76.6	3	0.7
<b>Census Region</b>							
Northeast	1048	370	35.3	655	62.5	23	2.2
Midwest	1036	449	43.3	575	55.5	12	1.2
South	1601	590	36.9	989	61.8	22	1.4
West	978	402	41.1	561	57.4	15	1.5
<b>Day of Week</b>							
Weekday	3156	1254	39.7	1848	58.6	54	1.7
Weekend	1507	557	37.0	932	61.8	18	1.2
<b>Season</b>							
Winter	1264	462	36.6	780	61.7	22	1.7
Spring	1181	469	39.7	691	58.5	21	1.8
Summer	1275	506	39.7	745	58.4	24	1.9
Fall	943	374	39.7	564	59.8	5	0.5
<b>Asthma</b>							
No	4287	1674	39.0	2563	59.8	50	1.2
Yes	341	131	38.4	207	60.7	3	0.9
DK	35	6	17.7	10	28.6	19	54.3
<b>Angina</b>							
No	4500	1750	38.9	2698	60.0	52	1.2
Yes	125	56	44.8	68	54.4	1	0.8
DK	38	50	13.2	14	36.8	19	50.0
<b>Bronchitis/Emphysema</b>							
No	4424	1726	9.0	2648	59.6	50	1.1
Yes	203	80	39.4	121	59.6	2	1.0
DK	36	5	13.9	11	30.6	20	55.6

Note: \* = Missing data; DK = Don't know; % = Row percentage; N = Sample size  
Source: Tsang and Klepeis, 1996.



Table 10-48. Number of Respondents Reporting Consumption of a Specified Number of Servings of Seafood in 1 Month

Population Group	Total N	Number of Servings in a Month					
		1-2	3-5	6-10	11-19	20+	DK
<b>Overall</b>	2780	918	990	519	191	98	64
<b>Gender</b>							
*	1311	405	458	261	101	57	29
Male	1468	512	532	258	90	41	35
Female	1	1	*	*	*	*	*
<b>Age (years)</b>							
*	42	13	16	5	4	1	3
1-4	102	55	29	12	2	*	4
5-11	166	72	57	21	6	4	6
12-17	137	68	54	9	2	1	3
18-64	1946	603	679	408	145	79	32
>64	387	107	155	64	32	13	16
<b>Race</b>							
*	2249	731	818	428	155	76	41
White	304	105	103	56	16	10	14
Black	56	15	17	11	5	5	3
Asian	56	22	18	6	5	3	2
Some Others	93	41	25	14	9	2	2
Hispanic	22	4	9	4	1	2	2
<b>Hispanic</b>							
*	2566	844	922	480	175	88	57
No	182	68	52	34	15	8	5
Yes	15	5	8	2	*	*	*
DK	17	1	8	3	1	2	2
<b>Employment</b>							
*	399	190	140	40	11	5	13
Full Time	1366	407	466	307	107	57	22
Part Time	236	70	95	46	14	8	3
Not Employed	766	249	285	124	57	26	25
Refused	13	2	4	2	2	2	1
<b>Education</b>							
*	434	205	149	47	12	7	14
< High School	198	88	62	20	6	10	12
High School Graduate	739	267	266	119	46	21	20
< College	584	161	219	122	48	26	8
College Graduate	484	115	183	121	43	17	5
Post Graduate	341	82	111	90	36	17	5
<b>Census Region</b>							
Northeast	655	191	241	137	62	12	12
Midwest	575	199	221	102	17	22	14
South	989	336	339	175	70	41	28
West	561	192	189	105	42	23	10
<b>Day of Week</b>							
Weekday	1848	602	661	346	129	70	40
Weekend	932	316	329	173	62	28	24
<b>Season</b>							
Winter	780	262	284	131	60	28	15
Spring	691	240	244	123	45	25	14
Summer	745	220	249	160	59	31	26
Fall	564	196	213	105	27	14	9
<b>Asthma</b>							
No	2563	846	917	475	180	88	57
Yes	207	69	71	42	11	9	5
DK	10	3	2	2	*	1	2
<b>Angina</b>							
No	2698	896	960	509	183	95	55
Yes	68	19	27	8	7	1	6
DK	14	3	3	2	1	2	3
<b>Bronchitis/Emphysema</b>							
No	2648	877	940	495	185	91	60
Yes	121	37	47	23	6	6	2
DK	11	4	3	1	*	1	2

Note: \* = Missing data; DK = Don't know; % = Row percentage; N = Sample size; Refused = Respondent refused to answer.  
Source: Tsang and Klepeis, 1996.



Table 10-49. Numer of Respondents Reporting Monthly Consumption of Seafood That Was Purchased or Caught by Someone They Knew

Population Group	Total N	*	Mostly Purchased	Mostly Caught	DK
<b>Overall</b>	2780	3	2584	154	39
<b>Gender</b>					
*	1311	1	1206	85	19
Male	1468	2	1377	69	20
Female	1	*	1	*	*
<b>Age (years)</b>					
*	42	*	39	3	*
1-4	102	*	94	8	*
5-11	166	*	153	9	4
12-17	137	*	129	6	2
18-64	1946	3	1810	106	27
>64	387	*	359	22	6
<b>Race</b>					
*	2249	1	2092	124	32
White	304	1	280	19	4
Black	56	*	50	4	2
Asian	56	*	55	*	1
Some Others	93	*	86	7	*
Hispanic	22	1	21	*	*
<b>Hispanic</b>					
*	2566	2	2387	140	37
No	182	*	169	13	*
Yes	15	*	12	1	2
DK	17	1	16	*	*
<b>Employment</b>					
*	399	*	368	25	6
Full Time	1366	2	1285	64	15
Part Time	236	1	217	15	3
Not Employed	766	*	701	50	15
Refused	13	*	13	*	*
<b>Education</b>					
*	434	*	401	26	7
< High School	198	*	174	20	4
High School Graduate	739	*	680	48	11
< College	584	2	547	28	7
College Graduate	484	*	460	19	5
Post Graduate	341	1	322	13	5
<b>Census Region</b>					
Northeast	655	2	627	21	5
Midwest	575	*	547	20	8
South	989	1	897	73	18
West	561	*	513	40	8
<b>Day of Week</b>					
Weekday	1848	2	1724	100	22
Weekend	932	1	860	54	17
<b>Season</b>					
Winter	780	*	741	35	4
Spring	691	*	655	27	9
Summer	745	2	674	54	15
Fall	564	1	514	38	11
<b>Asthma</b>					
No	2563	2	2384	142	35
Yes	207	1	190	12	4
DK	10	*	10	*	*
<b>Angina</b>					37
No	2698	3	2507	151	2
Yes	68	*	63	3	*
DK	14	*	14	*	*
<b>Bronchitis/Emphysema</b>					
No	2648	3	2457	149	39
Yes	121	*	116	5	*
DK	11	*	11	*	*

Note: \* = Missing data; DK = Don't know; N = Sample size; Refused = Respondent refused to answer.  
Source: Tsang and Klepeis, 1996.





Table 10-50. Estimated Number of Participants in Marine Recreational Fishing by State and Subregion

Subregion	State	Coastal Participants	Non Coastal Participants	Out of State <sup>a</sup>	Total Participants <sup>a</sup>
Pacific	So. California	902	8	159	910
	N. California	534	99	63	633
	Oregon	<u>265</u>	<u>19</u>	78	284
	TOTAL	1,701	126		
North Atlantic	Connecticut	186	* <sup>b</sup>	47	186
	Maine	93	9	100	102
	Massachusetts	377	69	273	446
	New Hampshire	34	10	32	44
	Rhode Island	<u>97</u>	*	157	97
	TOTAL	787	88		
Mid-Atlantic	Delaware	90	*	159	90
	Maryland	540	32	268	572
	New Jersey	583	9	433	592
	New York	539	13	70	552
	Virginia	<u>294</u>	<u>29</u>	131	323
	TOTAL	1,046	83		
South Atlantic	Florida	1,201	*	741	1,201
	Georgia	89	61	29	150
	N. Carolina	398	224	745	622
	S. Carolina	<u>131</u>	<u>77</u>	304	208
	TOTAL	1,819	362		
Gulf of Mexico	Alabama	95	9	101	104
	Florida	1,053	*	1,349	1,053
	Louisiana	394	48	63	442
	Mississippi	<u>157</u>	<u>42</u>	51	200
	TOTAL	<u>1,699</u>	<u>99</u>		
GRAND TOTAL		8,053	760		

<sup>a</sup> Not additive across states. One person can be counted as "OUT OF STATE" for more than one state.  
<sup>b</sup> An asterisk (\*) denotes no non-coastal counties in state.  
Source: NMFS, 1993.



Table 10-51. Estimated Weight of Fish Caught (Catch Type A and B1) by Marine Recreational Fishermen, by Wave and Subregion

	Atlantic and Gulf		Pacific	
	Region	Weight (1000 kg)	Region	Weight (1000 kg)
Jan/Feb	South Atlantic	1,060	So. California	418
	Gulf	<u>3,683</u>	N. California	101
			Oregon	<u>165</u>
	TOTAL	4,743	TOTAL	684
Mar/Apr	North Atlantic	310	So. California	590
	Mid Atlantic	1,030	N. California	346
	South Atlantic	1,913	Oregon	<u>144</u>
	Gulf	<u>3,703</u>	TOTAL	1,080
	TOTAL	6,956		
May/Jun	North Atlantic	3,272	So. California	1,195
	Mid Atlantic	4,815	N. California	563
	South Atlantic	4,234	Oregon	<u>581</u>
	Gulf	<u>5,936</u>	TOTAL	2,339
	TOTAL	18,257		
Jul/Aug	North Atlantic	4,003	So. California	1,566
	Mid Atlantic	9,693	N. California	1,101
	South Atlantic	4,032	Oregon	<u>39</u>
	Gulf	<u>5,964</u>	TOTAL	2,706
	TOTAL	23,692		
Sep/Oct	North Atlantic	2,980	So. California	859
	Mid Atlantic	7,798	N. California	1,032
	South Atlantic	3,296	Oregon	<u>724</u>
	Gulf	<u>7,516</u>	TOTAL	2,615
	TOTAL	21,590		
Nov/Dec	North Atlantic	456	So. California	447
	Mid Atlantic	1,649	N. California	417
	South Atlantic	2,404	Oregon	<u>65</u>
	Gulf	<u>4,278</u>	TOTAL	929
	TOTAL	8,787		
	GRAND TOTAL	84,025	GRAND TOTAL	10,353

Source: NMFS, 1993.



Table 10-52. Average Daily Intake (g/day) of Marine Finfish, by Region and Coastal Status

Region <sup>a</sup>	Intake Among Anglers				
	Mean	95th Percentile	Per-Capita (Coastal) <sup>b</sup>	Per-Capita (Coastal & Non-Coastal) <sup>c</sup>	Proportion of Population Coastal
N. Atlantic	6.2	20.1	1.2	1.1	0.82
Mid-Atlantic	6.3	18.9	1.2	0.9	0.70
S. Atlantic	4.7	15.9	1.5	1.0	0.51
All Atlantic	5.6	18.0	1.3	0.9	0.66
Gulf	7.2	26.1	3.0	1.9	0.60
S. California	2.0	5.5	0.2	0.2	0.96
N. California	2.0	5.7	0.3	0.3	0.70
Oregon	2.2	8.9	0.5	0.5	0.87
All Pacific	2.0	6.8	0.3	0.3	0.86

<sup>a</sup> N. Atlantic - ME, NH, MA, RI, and CT; Mid-Atlantic - NY, NJ, MD, DE, and VA; S. Atlantic - NC, SC, GA, and FL (Atlantic Coast); Gulf - AL, MS, LA, and FL (Gulf Coast).

<sup>b</sup> Mean intake rate among entire coastal population of region.

<sup>c</sup> Mean intake rate among entire population of region.

Source: NMFS, 1993.

Table 10-53. Estimated Weight of Fish Caught (Catch Type A and B1)<sup>a</sup> by Marine Recreational Fishermen by Species Group and Subregion, Atlantic and Gulf

	North Atlantic (1,000 kg)	Mid Atlantic (1,000 kg)	South Atlantic (1,000 kg)	Gulf (1,000 kg)	All Regions (1,000 kg)
Cartilaginous fishes	66	1,673	162	318	2,219
Eels	14	9	* <sup>b</sup>	0 <sup>c</sup>	23
Herrings	118	69	1	89	177
Catfishes	0	306	138	535	979
Toadfishes	0	7	0	*	7
Cods and Hakes	2,404	988	4	0	1,396
Searobins	2	68	*	*	70
Sculpins	1	*	0	0	1
Temperate Basses	837	2,166	22	4	2,229
Sea Basses	22	2,166	644	2,477	5,309
Bluefish	4,177	3,962	1,065	158	5,362
Jacks	0	138	760	2,477	3,375
Dolphins	65	809	2,435	1,599	4,908
Snappers	0	*	508	3,219	3,727
Grunts	0	9	239	816	1,064
Porgies	132	417	1,082	2,629	4,160
Drums	3	2,458	2,953	9,866	15,280
Mulletts	1	43	382	658	1,084
Barracudas	0	*	356	244	600
Wrasses	783	1,953	46	113	2,895
Mackerels and Tunas	878	3,348	4,738	4,036	13,000
Flounders	512	4,259	532	377	5,680
Triggerfishes/Filefishes	0	48	109	544	701
Puffers	*	16	56	4	76
Other fishes	105	72	709	915	1,801

<sup>a</sup> For Catch Type A and B1, the fish were not thrown back.

<sup>b</sup> An asterisk (\*) denotes data not reported.

<sup>c</sup> Zero (0) = < 1000 kg.

Source: NMFS, 1993.



Chapter 10 - Intake of Fish and Shellfish

Table 10-54. Estimated Weight of Fish Caught (Catch Type A and B1) <sup>a</sup> by Marine Recreational Fishermen by Species Group and Subregion, Pacific				
Species Group	Southern California (1,000 kg)	Northern California (1,000 kg)	Oregon (1,000 kg)	Total
Cartilaginous fish	35	162	1	198
Sturgeons	0 <sup>b</sup>	89	13	102
Herrings	10	15	40	65
Anchovies	* <sup>c</sup>	7	0	7
Smelts	0	71	0	71
Cods and Hakes	0	0	0	0
Silversides	58	148	0	206
Striped Bass	0	51	0	51
Sea Basses	1,319	17	0	1,336
Jacks	469	17	1	487
Croakers	141	136	0	277
Sea Chubs	53	1	0	54
Surfperches	74	221	47	342
Pacific Barracuda	866	10	0	876
Wrasses	73	5	0	78
Tunas and Mackerels	1,260	36	1	1,297
Rockfishes	409	1,713	890	3,012
California Scorpionfish	86	0	0	86
Sablefishes	0	0	5	5
Greenlings	22	492	363	877
Sculpins	6	81	44	131
Flatfishes	106	251	5	362
Other fishes	89	36	307	432

<sup>a</sup> For Catch Type A and B1, the fish were not thrown back.  
<sup>b</sup> Zero (0) = <1000 kg.  
<sup>c</sup> An asterisk (\*) denotes data not reported.  
 Source: NMFS, 1993.

Table 10-55. Median Intake Rates Based on Demographic Data of Sport Fishermen and Their Family/Living Group		
	Percent of total interviewed	Median intake rates (g/person-day)
<u>Ethnic Group</u>		
Caucasian	42	46.0
Black	24	24.2
Mexican-American	16	33.0
Oriental/Samoan	13	70.6
Other	5	-- <sup>a</sup>
<u>Age (years)</u>		
< 17	11	27.2
18 - 40	52	32.5
41 - 65	28	39.0
> 65	9	113.0

<sup>a</sup> Not reported.  
 Source: Puffer et al., 1981.



Table 10-56. Cumulative Distribution of Total Fish/Shellfish Consumption by Surveyed Sport Fishermen in the Metropolitan Los Angeles Area

Percentile	Intake rate (g/person-day)
5	2.3
10	4.0
20	8.3
30	15.5
40	23.9
50	36.9
60	53.2
70	79.8
80	120.8
90	224.8
95	338.8

Source: Puffer et al. (1981).

Table 10-57. Catch Information for Primary Fish Species Kept by Sport Fishermen (n = 1059)

Species	Average Weight (Grams)	Percent of Fishermen who Caught
White Croaker	153	34
Pacific Mackerel	334	25
Pacific Bonito	717	18
Queenfish	143	17
Jacksnelt	223	13
Walleye Perch	115	10
Shiner Perch	54	7
Opaleye	307	6
Black Perch	196	5
Kelp Bass	440	5
California Halibut	1752	4
Shellfish <sup>a</sup>	421	3

<sup>a</sup> Crab, mussels, lobster, abalone.

Source: Modified from Puffer et al., 1981.

Table 10-58. Percent of Fishing Frequency During the Summer and Fall Seasons in Commencement Bay, Washington

Fishing Frequency	Frequency Percent in the Summer <sup>a</sup>	Frequency Percent in the Fall <sup>b</sup>	Frequency Percent in the Fall <sup>c</sup>
Daily	10.4	8.3	5.8
Weekly	50.3	52.3	51.0
Monthly	20.1	15.9	21.1
Bimonthly	6.7	3.8	4.2
Biyearly	4.4	6.1	6.3
Yearly	8.1	13.6	11.6

<sup>a</sup> Summer - July through September, includes 5 survey days and 4 survey areas (i.e., area #1, #2, #3 and #4)

<sup>b</sup> Fall - September through November, includes 4 survey days and 4 survey areas (i.e., area #1, #2, #3 and #4)

<sup>c</sup> Fall - September through November, includes 4 survey days described in footnote <sup>b</sup> plus an additional survey area (5 survey areas) (i.e., area #1, #2, #3, #4 and #5)

Source: Pierce et al., 1981.



Table 10-59. Selected Percentile Consumption Estimates (g/day) for the Survey and Total Angler Populations Based on the Reanalysis of the Puffer et al. (1981) and Pierce et al. (1981) Data		
	50th Percentile	90th Percentile
Survey Population		
Puffer et al. (1981)	37	225
Pierce et al. (1981)	<u>19</u>	<u>155</u>
Average	28	190
Total Angler Population		
Puffer et al. (1981)	2.9 <sup>a</sup>	35 <sup>b</sup>
Pierce et al. (1981)	<u>1.0</u>	<u>13</u>
Average	2.0	24
<sup>a</sup> Estimated based on the average intake for the 0 - 90th percentile anglers. <sup>b</sup> Estimated based on the average intake for the 91st - 96th percentile anglers. Source: Price et al., 1994.		

Table 10-60. Means and Standard Deviations of Selected Characteristics by Subpopulation Groups in Everglades, Florida		
Variables (N <sup>a</sup> =330)	Mean ± Std. Dev. <sup>b</sup>	Range
Age (years)	38.6 ± 18.8	2 - 81
Sex		
Female	38%	--
Male	62%	--
Race/ethnicity		
Black	46%	--
White	43%	--
Hispanic	11%	--
Number of Years Fished	15.8 ± 15.8	0 - 70
Number Per Week Fished in Past 6 Months of Survey Period	1.8 ± 2.5	0 - 20
Number Per Week Fished in Last Month of Survey Period	1.5 ± 1.4	0 - 12
Aware of Health Advisories	71%	--
<sup>a</sup> Number of respondents who reported consuming fish <sup>b</sup> Std. Dev. = standard deviation Source: U.S. DHHS, 1995		



Table 10-61. Mean Fish Intake Among Individuals Who Eat Fish and Reside in Households With Recreational Fish Consumption

Group	All Fish meals/week	Recreational Fish meals/week	n	Total Fish grams/day	Recreational Fish grams/day	Total Fish grams/ kg/day	Recreational Fish grams/ kg/day
All household members	0.686	0.332	2196	21.9	11.0	0.356	0.178
Respondents (i.e., licensed anglers)	0.873	0.398	748	29.4	14.0	0.364	0.168
<u>Age Groups (years)</u>							
1-5	0.463	0.223	121	11.4	5.63	0.737	0.369
6 to 10	0.49	0.278	151	13.6	7.94	0.481	0.276
11 to 20	0.407	0.229	349	12.3	7.27	0.219	0.123
21 to 40	0.651	0.291	793	22	10.2	0.306	0.139
41 to 60	0.923	0.42	547	29.3	14.2	0.387	0.186
61 to 70	0.856	0.431	160	28.2	14.5	0.377	0.193
71 to 80	1.0	0.622	45	32.3	20.1	0.441	0.271
80+	0.8	0.6	10	26.5	20	0.437	0.345

Source: U.S. EPA analysis using data from West et al., 1989.

Table 10-62. Comparison of Seven-Day Recall and Estimated Seasonal Frequency for Fish Consumption

Usual Fish Consumption Frequency Category	Mean Fish Meals/Week 7-day Recall Data	Usual frequency Value Selected for Data Analysis (times/week)
Almost daily	no data	4 [if needed]
2-4 times a week	1.96	2
Once a week	1.19	1.2
2-3 times a month	0.840 (3.6 times/month)	0.7 (3 times/month)
Once a month	0.459 (1.9 times/month)	0.4 (1.7 times/month)
Less often	0.306 (1.3 times/month)	0.2 (0.9 times/month)

Source: U.S. EPA analysis using data from West et al., 1989.

Table 10-63. Distribution of Usual Fish Intake Among Survey Main Respondents Who Fished and Consumed Recreationally Caught Fish

	All Fish Meals/Week	Recreational Fish Meals/Week	All Fish Intake grams/day	Recreational Fish Intake grams/day	All Fish Intake grams/ kg/day	Recreational Fish Intake grams/kg/day
n	738	738	738	738	726	726
mean	0.859	0.447	27.74	14.42	0.353	0.1806
10%	0.300	0.040	9.69	1.29	0.119	0.0159
25%	0.475	0.125	15.34	4.04	0.187	0.0504
50%	0.750	0.338	24.21	10.90	0.315	0.1357
75%	1.200	0.672	38.74	21.71	0.478	0.2676
90%	1.400	1.050	45.20	33.90	0.634	0.4146
95%	1.800	1.200	58.11	38.74	0.747	0.4920

Source: U.S. EPA analysis using data from West et al., 1989.



Table 10-64. Estimates of Fish Intake Rates of Licensed Sport Anglers in Maine During the 1989-1990 Ice Fishing or 1990 Open-Water Seasons <sup>a</sup>				
Intake Rates (grams/day)				
Percentile Rankings	All Waters <sup>b</sup>		Rivers and Streams	
	All Anglers <sup>c</sup> (N = 1,369)	Consuming Anglers <sup>d</sup> (N = 1,053)	River Anglers <sup>e</sup> (N = 741)	Consuming Anglers <sup>d</sup> (N = 464)
50th (median)	1.1	2.0	0.19	0.99
66th	2.6	4.0	0.71	1.8
75th	4.2	5.8	1.3	2.5
90th	11.0	13.0	3.7	6.1
95th	21.0	26.0	6.2	12.0
Arithmetic Mean <sup>f</sup>	5.0	6.4	1.9	3.7
	[79]	[77]	[82]	[81]

<sup>a</sup> Estimates are based on rank except for those of arithmetic mean.  
<sup>b</sup> All waters based on fish obtained from all lakes, ponds, streams and rivers in Maine, from other household sources and from other non-household sources.  
<sup>c</sup> Licensed anglers who fished during the seasons studied and did or did not consume freshwater fish, and licensed anglers who did not fish but ate freshwater fish caught in Maine during those seasons.  
<sup>d</sup> Licensed anglers who consumed freshwater fish caught in Maine during the seasons studied.  
<sup>e</sup> Those of the "all anglers" who fished on rivers or streams (consumers and nonconsumers).  
<sup>f</sup> Values in brackets [ ] are percentiles at the mean consumption rates.  
 Source: Chemrisk, 1991; Ebert et al., 1993.

Table 10-65. Analysis of Fish Consumption by Ethnic Groups for "All Waters" (g/day) <sup>a</sup>						
Consuming Anglers <sup>b</sup>						
	French Canadian Heritage	Irish Heritage	Italian Heritage	Native American Heritage	Other White Non-Hispanic Heritage	Scandinavian Heritage
N of Cases	201	138	27	96	533	37
Median (50th percentile) <sup>c,d</sup>	2.3	2.4	1.8	2.3	1.9	1.3
66th percentile <sup>c,d</sup>	4.1	4.4	2.6	4.7	3.8	2.6
75th percentile <sup>c,d</sup>	6.2	6.0	5.0	6.2	5.7	4.9
Arithmetic Mean <sup>c</sup>	7.4	5.2	4.5	10	6.0	5.3
Percentile at the Mean <sup>d</sup>	80	70	74	83	76	78
90th percentile <sup>c,d</sup>	15	12	12	16	13	9.4
95th percentile <sup>c,d</sup>	27	20	21	51	24	25
Percentile at 6.5 g/day <sup>d,e</sup>	77	75	81	77	77	84

<sup>a</sup> "All Waters" based on fish obtained from all lakes, ponds, streams and rivers in Maine, from other household sources and from other non-household sources.  
<sup>b</sup> "Consuming Anglers" refers to only those anglers who consumed freshwater fish obtained from Maine sources during the 1989-1990 ice fishing or 1990 open water fishing season.  
<sup>c</sup> The average consumption per day by freshwater fish consumers in the household.  
<sup>d</sup> Calculated by rank without any assumption of statistical distribution.  
<sup>e</sup> Fish consumption rate recommended by U.S. EPA (1984) for use in establishing ambient water quality standards.  
 Source: Chemrisk, 1991.





Table 10-66. Total Consumption of Freshwater Fish Caught by All Survey Respondents During the 1990 Season

Species	Ice Fishing		Lakes and Ponds		Rivers and Streams	
	Quantity Consumed (#)	Grams (x10 <sup>3</sup> ) Consumed	Quantity Consumed (#)	Grams (x10 <sup>3</sup> ) Consumed	Quantity Consumed (#)	Grams (x10 <sup>3</sup> ) Consumed
Landlocked salmon	832	290	928	340	305	120
Atlantic salmon	3	1.1	33	9.9	17	11
Togue (Lake trout)	483	200	459	160	33	2.7
Brook trout	1,309	100	3,294	210	10,185	420
Brown trout	275	54	375	56	338	23
Yellow perch	235	9.1	1,649	52	188	7.4
White perch	2,544	160	6,540	380	3,013	180
Bass (smallmouth and largemouth)	474	120	73	5.9	787	130
Pickeral	1,091	180	553	91	303	45
Lake whitefish	111	20	558	13	55	2.7
Hornpout (Catfish and bullheads)	47	8.2	1,291	100	180	7.8
Bottom fish (Suckers, carp and sturgeon)	50	81	62	22	100	6.7
Chub	0	0	252	35	219	130
Smelt	7,808	150	428	4.9	4,269	37
Other	201	210	90	110	54	45
<b>TOTALS</b>	<b>15,463</b>	<b>1,583.4</b>	<b>16,587</b>	<b>1,590</b>	<b>20,046</b>	<b>1,168</b>

Source: Chemrisk, 1991.

Table 10-67. Mean Sport-Fish Consumption by Demographic Variables, Michigan Sport Anglers Fish Consumption Study, 1991-1992

	N	Mean (g/day)	95% C.I.
<u>Income<sup>a</sup></u>			
<\$15,000	290	21.0	16.3 - 25.8
\$15,000 - \$24,999	369	20.6	15.5 - 25.7
\$25,000 - \$39,999	662	17.5	15.0 - 20.1
>\$40,000	871	14.7	12.8 - 16.7
<u>Education</u>			
Some High School	299	16.5	12.9 - 20.1
High School Degree	1,074	17.0	14.9 - 19.1
Some College-College Degree	825	17.6	14.9 - 20.2
Post Graduate	231	14.5	10.5 - 18.6
<u>Residence Size<sup>b</sup></u>			
Large City/Suburb (>100,000)	487	14.6	11.8 - 17.3
Small City (20,000-100,000)	464	12.9	10.7 - 15.0
Town (2,000-20,000)	475	19.4	15.5 - 23.3
Small Town (100-2,000)	272	22.8	16.8 - 28.8
Rural, Non Farm	598	17.7	15.1 - 20.3
Farm	140	15.1	10.3 - 20.0
<u>Age (years)</u>			
16-29	266	18.9	13.9 - 23.9
30-39	583	16.6	13.5 - 19.7
40-49	556	16.5	13.4 - 19.6
50-59	419	16.5	13.6 - 19.4
60+	596	16.2	13.8 - 18.6
<u>Sex<sup>a</sup></u>			
Male	299	17.5	15.8 - 19.1
Female	1,074	13.7	11.2 - 16.3
<u>Race/Ethnicity<sup>b</sup></u>			
Minority	160	23.2	13.4 - 33.1
White	2,289	16.3	14.9 - 17.6

<sup>a</sup> P < .01, F test

<sup>b</sup> P < .05, F test

Source: West et al., 1993



Chapter 10 - Intake of Fish and Shellfish

Table 10-68. Distribution of Fish Intake Rates (from all sources and from sport-caught sources) For 1992 Lake Ontario Anglers		
Percentile of Lake Ontario Anglers	Fish from All Sources (g/day)	Sport-Caught Fish (g/day)
25%	8.8	0.6
50%	14.1	2.2
75%	23.2	6.6
90%	34.2	13.2
95%	42.3	17.9
99%	56.6	39.8

Source. Connelly et al., 1996.

Table 10-69. Mean Annual Fish Consumption (g/day) for Lake Ontario Anglers, 1992, by Sociodemographic Characteristics		
Demographic Group	Mean Consumption	
	Fish from all Sources	Sport-Caught Fish
Overall	17.9	4.9
<u>Residence</u>		
Rural	17.6	5.1
Small City	20.8	6.3
City (25-100,000)	19.8	5.8
City (> 100,000)	13.1	2.2
<u>Income</u>		
< \$20,000	20.5	4.9
\$21,000-34,000	17.5	4.7
\$34,000-50,000	16.5	4.8
>\$50,000	20.7	6.1
<u>Age (years)</u>		
<30	13.0	4.1
30-39	16.6	4.3
40-49	18.6	5.1
50+	21.9	6.4
<u>Education</u>		
< High School	17.3	7.1
High School Graduate	17.8	4.7
Some College	18.8	5.5
College Graduate	17.4	4.2
Some Post Grad.	20.5	5.9

Note - Scheffe's test showed statistically significant differences between residence types (for all sources and sport caught) and age groups (all sources).  
Source: Connelly et al., 1996.



Percentile	Annual Number of Sport Caught Meals	Intake Rate of Sport-Caught Meals (g/day)
25th	4	1.7
50th	10	4.1
75th	25	10.2
90th	50	20.6
95th	60	24.6
98th	100	41.1
100th	365	150
Mean	18	7.4

Source: Raw data on sport-caught meals from Fiore et al., 1989. EPA calculated intake rates using a value of 150 grams per fish meal; this value is derived from Pao et al., 1982.

Category	Subcategory	Percent of Total <sup>a</sup>
Geographic Distribution	Upper Hudson	18 %
	Mid Hudson	35 %
	Lower Hudson	48 %
Age Distribution (years)	< 14	3 %
	15 - 29	26 %
	30 - 44	35 %
	45 - 59	23 %
	> 60	12 %
Annual Household Income	< \$10,000	16 %
	\$10 - 29,999	41 %
	\$30 - 49,999	29 %
	\$50 - 69,999	10 %
	\$70 - 89,999	2 %
	> \$90,000	3 %
Ethnic Background	Caucasian American	67 %
	African American	21 %
	Hispanic American	10 %
	Asian American	1 %
	Native American	1 %

<sup>a</sup> A total of 336 shore-based anglers were interviewed  
Source: Hudson River Sloop Clearwater, Inc., 1993



Table 10-72. Number of Grams Per Day of Fish Consumed by All Adult Respondents (Consumers and Non-consumers Combined) - Throughout the Year				
Number of Grams/Day	Cumulative Percent	Number of Grams/Day	Cumulative Percent	
0.00	8.9%	64.8	80.6%	
1.6	9.0%	72.9	81.2%	
3.2	10.4%	77.0	81.4%	
4.0	10.8%	81.0	83.3%	
4.9	10.9%	97.2	89.3%	
6.5	12.8%	130	92.2%	
7.3	12.9%	146	93.7%	
8.1	13.7%	162	94.4%	
9.7	14.4%	170	94.8%	
12.2	14.9%	194	97.2%	
13.0	16.3%	243	97.3%	
16.2	22.8%	259	97.4%	
19.4	24.0%	292	97.6%	
20.2	24.1%	324	98.3%	
24.3	27.9%	340	98.7%	
29.2	28.1%	389	99.0%	
32.4	52.5%	486	99.6%	
38.9	52.9%	648	99.7%	
40.5	56.5%	778	99.9%	
48.6	67.6%	972	100%	

N = 500  
 Weighted Mean = 58.7 grams/day (g/d)  
 Weighted SE = 3.64  
 90th Percentile: 97.2 g/d < (90th) < 130 g/d  
 95th Percentile ≈ 170 g/d  
 99th Percentile = 389 g/d  
 Source: CRITFC, 1994

Table 10-73. Fish Intake Throughout the Year by Sex, Age, and Location by All Adult Respondents			
	N	Weighted Mean (grams/day)	Weighted SE
<u>Sex</u>			
Female	278	55.8	4.78
Male	222	62.6	5.60
Total	500	58.7	3.64
<u>Age (years)</u>			
18-39	287	57.6	4.87
40-59	155	55.8	4.88
60 & Older	58	74.4	15.3
Total	500	58.7	3.64
<u>Location</u>			
On Reservation	440	60.2	3.98
Off Reservation	60	47.9	8.25
Total	500	58.7	3.64

Source: CRITFC, 1994.



Table 10-74. Children's Fish Consumption Rates - Throughout Year

Number of Grams/Day	Unweighted Cumulative Percent
0.0	21.1%
0.4	21.6%
0.8	22.2%
1.6	24.7%
2.4	25.3%
3.2	28.4%
4.1	32.0%
4.9	33.5%
6.5	35.6%
8.1	47.4%
9.7	48.5%
12.2	51.0%
13.0	51.5%
16.2	72.7%
19.4	73.2%
20.3	74.2%
24.3	76.3%
32.4	87.1%
48.6	91.2%
64.8	94.3%
72.9	96.4%
81.0	97.4%
97.2	98.5%
162.0	100%

N = 194  
 Unweighted Mean = 19.6 grams/day  
 Unweighted SE = 1.94

Source: CRITFC, 1994.

Table 10-75. Sociodemographic Factors and Recent Fish Consumption

	Peak Consumption <sup>a</sup>		Recent Consumption <sup>b</sup>			
	Average <sup>c</sup>	≥3 <sup>d</sup> (%)	Walleye	N. Pike	Muskellunge	Bass
All participants (N-323)	1.7	20	4.2	0.3	0.3	0.5
Gender						
Male (n-148)	1.9	26	5.1	0.5 <sup>a</sup>	0.5	0.7 <sup>a</sup>
Female (n-175)	1.5	15	3.4	0.2	0.1	0.3
Age (y)						
<35 (n-150)	1.8	23	5.3 <sup>a</sup>	0.3	0.2	0.7
≥35 (n-173)	1.6	17	3.2	0.4	0.3	0.3
High School Graduate						
No (n-105)	1.6	18	3.6	0.2	0.4	0.7
Yes (n-218)	1.7	21	4.4	0.4	0.2	0.4
Unemployed						
Yes (n-78)	1.9	27	4.8	0.6	0.6	1.1
No (n-245)	1.6	18	4.0	0.3	0.2	0.3

<sup>a</sup> Highest number of fish meals consumed/week.  
<sup>b</sup> Number of meals of each species in the previous 2 months.  
<sup>c</sup> Average peak fish consumption.  
<sup>d</sup> Percentage of population reporting peak fish consumption of ≥3 fish meals/week.

Source: Peterson et al., 1994.



Chapter 10 - Intake of Fish and Shellfish

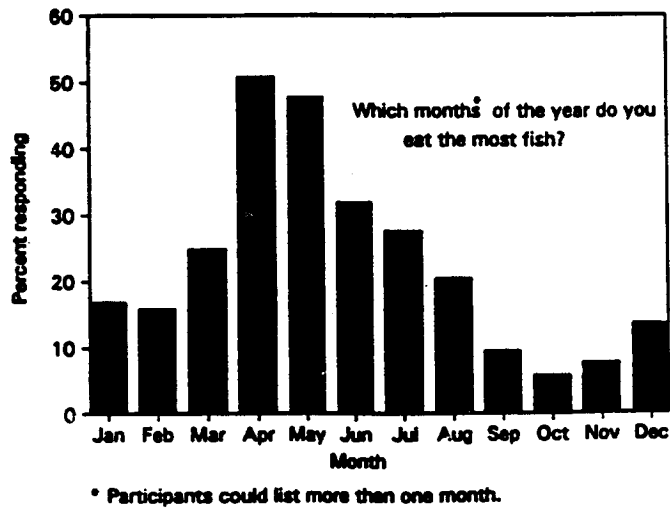

Figure 10-1. Sesonal Fish Consumption: Wisconsin Chippewa, 1990

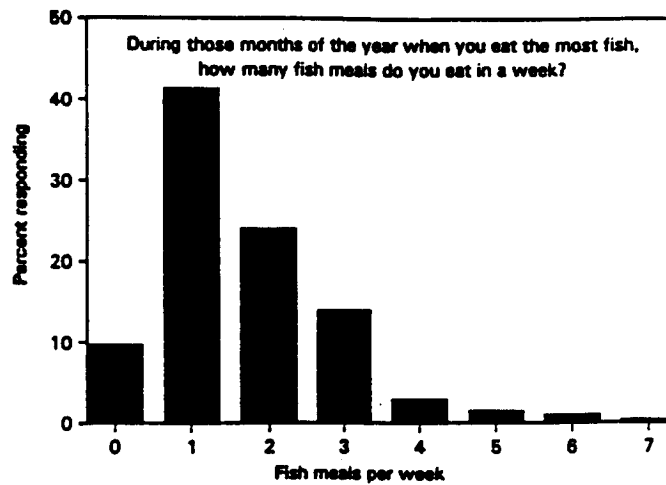

Figure 10-2. Peak Fish Consumption: Wisconsin Chippewa, 1990.

Source: Peterson et al., 1994.



Table 10-76. Number of Local Fish Meals Consumed Per Year by Time Period for All Respondents

Number of Local Fish Meals Consumed Per Year	Time Period											
	During Pregnancy				≤ 1 Yr. Before Pregnancy <sup>a</sup>				>Yr. Before Pregnancy <sup>b</sup>			
	Mohawk		Control		Mohawk		Control		Mohawk		Control	
	N <sup>c</sup>	%	N <sup>c</sup>	%	N <sup>c</sup>	%	N <sup>c</sup>	%	N <sup>c</sup>	%	N <sup>c</sup>	%
None	63	64.9	109	70.8	42	43.3	99	64.3	20	20.6	93	60.4
1 - 9	24	24.7	24	15.6	40	41.2	31	20.1	42	43.3	35	22.7
10 - 19	5	5.2	7	4.5	4	4.1	6	3.9	6	6.2	8	5.2
20 - 29	1	1.0	5	3.3	3	3.1	3	1.9	9	9.3	5	3.3
30 - 39	0	0.0	2	1.3	0	0.0	3	1.9	1	1.0	1	0.6
40 - 49	0	0.0	1	0.6	1	1.0	1	0.6	1	1.0	1	0.6
50+	4	4.1	6	3.9	7	7.2	11	7.1	18	18.6	11	7.1
Total	97	100.0	154	100.	97	100.	154	100.	97	100.	154	100.0
			0		0		0		0		0	

<sup>a</sup> p <0.05 for Mohawk vs. Control.  
<sup>b</sup> p <0.001 for Mohawk vs. Control.  
<sup>c</sup> N = number of respondents.  
Source: Fitzgerald et al., 1995.

Table 10-77. Mean Number of Local Fish Meals Consumed Per Year by Time Period for All Respondents and Consumers Only

	All Respondents (N=97 Mohawks and 154 Controls)			Consumers Only (N=82 Mohawks and 72 Controls)		
	During Pregnancy	≤ 1 Yr. Before Pregnancy	>1 Yr. Before Pregnancy	During Pregnancy	≤ 1 Yr. Before Pregnancy	>1 Yr. Before Pregnancy
Mohawk	3.9 (1.2)	9.2 (2.3)	23.4 (4.3) <sup>a</sup>	4.6 (1.3)	10.9 (2.7)	27.6 (4.9)
Control	7.3 (2.1)	10.7 (2.6)	10.9 (2.7)	15.5 (4.2) <sup>a</sup>	23.0 (5.1) <sup>b</sup>	23.0 (5.5)

<sup>a</sup> p <0.001 for Mohawk vs. Control.  
<sup>b</sup> p <0.05 for Mohawk vs. Control  
( ) = standard error.  
Test for linear trend:  
p <0.001 for Mohawk (All participants and consumers only);  
p = 0.07 for Controls (All participants and consumers only).  
Source: Fitzgerald et al., 1995.



Chapter 10 - Intake of Fish and Shellfish

Table 10-78. Mean Number of Local Fish Meals Consumed Per Year by Time Period and Selected Characteristics for All Respondents (Mohawk, N=97; Control, N=154)

Background Variable	Time Period					
	During Pregnancy		<1 Year Before Pregnancy		>1 Year Before Pregnancy	
	Mohawk	Control	Mohawk	Control	Mohawk	Control
Age (Yrs)						
<20	7.7	0.8	13.5	13.9	27.4	10.4
20 - 24	1.3	5.9	5.7	14.5	20.4	15.9
25 - 29	3.9	9.9	15.5	6.2	25.1	5.4
30 - 34	12.0	7.6	9.5	2.9	12.0	5.6
>34	1.8	11.2	1.8	26.2	52.3	22.1 <sup>a</sup>
Education (Yrs)						
<12	6.3	7.9	14.8	12.4	24.7	8.6
12	7.3	5.4	8.1	8.4	15.3	11.4
13 - 15	1.7	10.1	8.0	15.4	29.2	13.3
>15	0.9	6.8	10.7	0.8	18.7	2.1
Cigarette Smoking						
Yes	3.8	8.8	10.4	13.0	31.6	10.9
No	3.9	6.4	8.4	8.3	18.1	10.8
Alcohol Consumption						
Yes	4.2	9.9	6.8	13.8	18.0	14.8
No	3.8	6.3 <sup>b</sup>	12.1	4.7 <sup>c</sup>	29.8	2.9 <sup>d</sup>

<sup>a</sup> F (4,149) = 2.66, p=0.035 for Age Among Controls.  
<sup>b</sup> F (1,152) = 3.77, p=0.054 for Alcohol Among Controls.  
<sup>c</sup> F (1,152) = 5.20, p=0.024 for Alcohol Among Controls.  
<sup>d</sup> F (1,152) = 6.42, p=0.012 for Alcohol Among Controls.  
 Source: Fitzgerald et al., 1995.

Table 10-79. Percentage of Individuals Using Various Cooking Methods at Specified Frequencies

Study	Use Frequency	Bake	Pan Fry	Deep Fry	Broil or Grill	Poach	Boil	Smoke	Raw	Other
Connelly et al., 1992	Always	24(a)	51	13		24(a)				
	Ever	75(a)	88	59		75(a)				
Connelly et al., 1996	Always	13	4	4						
	Ever	84	72	42						
CRITFC, 1994	At least monthly	79	51	14	27	11	46	31	1	34(b) 29(c) 49(d)
	Ever	98	80	25	39	17	73	66	3	67(b) 71(c) 75(d)
Fitzgerald et al., 1995	Not Specified		94(e)(f)	71(e)(g)						
Puffer et al., 1981	As Primary Method	16.3	52.5	12					0.25	19(h)

<sup>a</sup> 24 and 75 listed as bake, BBQ, or poach  
<sup>b</sup> Dried  
<sup>c</sup> Roasted  
<sup>d</sup> Canned  
<sup>e</sup> Not specified whether deep or pan fried  
<sup>f</sup> Mohawk women  
<sup>g</sup> Control population  
<sup>h</sup> boil, stew, soup, or steam





Table 10-80. Percent Moisture and Fat Content for Selected Species<sup>a</sup>

Species	Moisture Content (%)	Total Fat Content (%) <sup>b</sup>	Comments
<b>FINFISH</b>			
Anchovy, European	73.37	4.101	Raw
Bass	50.30	8.535	Canned in oil, drained solids
Bass, Striped	75.66	3.273	Freshwater, mixed species, raw
Bluefish	79.22	1.951	Raw
Butterfish	70.86	3.768	Raw
Carp	74.13	NA	Raw
Catfish	76.31	4.842	Raw
	69.63	6.208	Cooked, dry heat
	76.39	3.597	Channel, raw
	58.81	12.224	Channel, cooked, breaded and fried
Cod, Atlantic	81.22	0.456	Atlantic, raw
	75.61	0.582	Canned, solids and liquids
	75.92	0.584	Cooked, dry heat
	16.14	1.608	Dried and salted
Cod, Pacific	81.28	0.407	Raw
Croaker, Atlantic	78.03	2.701	Raw
	59.76	11.713	Cooked, breaded and fried
Dolphinfish, Mahimahi	77.55	0.474	Raw
Drum, Freshwater	77.33	4.463	Raw
Flatfish, Flounder and Sole	79.06	0.845	Raw
	73.16	1.084	Cooked, dry heat
Grouper	79.22	0.756	Raw, mixed species
	73.36	0.970	Cooked, dry heat
Haddock	79.92	0.489	Raw
	74.25	0.627	Cooked, dry heat
	71.48	0.651	Smoked
Halibut, Atlantic & Pacific	77.92	1.812	Raw
	71.69	2.324	Cooked, dry heat
Halibut, Greenland	70.27	12.164	Raw
Herring, Atlantic & Turbot, domestic species	72.05	7.909	Raw
	64.16	10.140	Cooked, dry heat
	59.70	10.822	Kipperd
	55.22	16.007	Pickled
Herring, Pacific	71.52	12.552	Raw
Mackerel, Atlantic	63.55	9.076	Raw
	53.27	15.482	Cooked, dry heat
Mackerel, Jack	69.17	4.587	Canned, drained solids
Mackerel, King	75.85	1.587	Raw
Mackerel, Pacific & Jack	70.15	6.816	Canned, drained solids
Mackerel, Spanish	71.67	5.097	Raw
	68.46	5.745	Cooked, dry heat
Monkfish	83.24	NA	Raw
Mullet, Striped	77.01	2.909	Raw
	70.52	3.730	Cooked, dry heat
Ocean Perch, Atlantic	78.70	1.296	Raw
	72.69	1.661	Cooked, dry heat
Perch, Mixed species	79.13	0.705	Raw
	73.25	0.904	Cooked, dry heat
Pike, Northern	78.92	0.477	Raw
	72.97	0.611	Cooked, dry heat
Pike, Walleye	79.31	0.990	Raw



Table 10-80. Percent Moisture and Fat Content for Selected Species<sup>a</sup> (continued)

Species	Moisture Content (%)	Total Fat Content (%) <sup>b</sup>	Comments
Pollock, Alaska & Walleye	81.56	0.701	Raw
	74.06	0.929	Cooked, dry heat
Pollock, Atlantic	78.18	0.730	Raw
Rockfish, Pacific, mixed species	79.26	1.182	Raw (Mixed species)
	73.41	1.515	Cooked, dry heat (mixed species)
Roughy, Orange	75.90	3.630	Raw
Salmon, Atlantic	68.50	5.625	Raw
Salmon, Chinook	73.17	9.061	Raw
	72.00	3.947	Smoked
Salmon, Chum	75.38	3.279	Raw
	70.77	4.922	Canned, drained solids with bone
Salmon, Coho	72.63	4.908	Raw
	65.35	6.213	Cooked, moist heat
Salmon, Pink	76.35	2.845	Raw
	68.81	5.391	Canned, solids with bone and liquid
Salmon, Red & Sockeye	70.24	4.560	Raw
	68.72	6.697	Canned, drained solids with bone
	61.84	9.616	Cooked, dry heat
Sardine, Atlantic	59.61	10.545	Canned in oil, drained solids with bone
Sardine, Pacific	68.30	11.054	Canned in tomato sauce, drained solids with bone
Sea Bass, mixed species	78.27	1.678	Cooked, dry heat
	72.14	2.152	Raw
Seatrout, mixed species	78.09	2.618	Raw
Shad, American	68.19	NA	Raw
Shark, mixed species	73.58	3.941	Raw
	60.09	12.841	Cooked, batter-dipped and fried
Snapper, mixed species	76.87	0.995	Raw
	70.35	1.275	Cooked, dry heat
Sole, Spot	75.95	3.870	Raw
Sturgeon, mixed species	76.55	3.544	Raw
	69.94	4.544	Cooked, dry heat
	62.50	3.829	Smoked
Sucker, white	79.71	1.965	Raw
Sunfish, Pumpkinseed	79.50	0.502	Raw
Swordfish	75.62	3.564	Raw
	68.75	4.569	Cooked, dry heat
Trout, mixed species	71.42	5.901	Raw
Trout, Rainbow	71.48	2.883	Raw
	63.43	3.696	Cooked, dry heat
	59.83	7.368	Canned in oil, drained solids
Tuna, light meat	74.51	0.730	Canned in water, drained solids
	64.02	NA	Canned in oil
Tuna, white meat	69.48	2.220	Canned in water, drained solids
	68.09	4.296	Raw
Tuna, Bluefish, fresh	59.09	5.509	Cooked, dry heat
	76.95	NA	Raw
Turbot, European	72.77	5.051	Raw
	70.83	0.799	Smoked
Whitefish, mixed species	80.27	0.948	Raw
	74.71	1.216	Cooked, dry heat
Whiting, mixed species	74.71	1.216	Cooked, dry heat
	74.52	NA	Raw
Yellowtail, mixed species	74.52	NA	Raw



Table 10-80. Percent Moisture and Fat Content for Selected Species<sup>a</sup> (continued)

Species	Moisture Content (%)	Total Fat Content (%) <sup>b</sup>	Comments
<b>SHELLFISH</b>			
Crab, Alaska King	79.57	NA	Raw
	77.55	0.854	Cooked, moist heat
Crab, Blue	79.02	0.801	Imitation, made from surimi
	79.16	0.910	Raw
	77.43	1.188	Canned (dry pack or drained solids of wet pack)
	71.00	6.571	Cooked, moist heat
Crab, Dungeness	79.18	0.616	Crab cakes
	80.58	0.821	Raw
Crab, Queen	80.79	0.732	Raw
	75.37	0.939	Cooked, moist heat
Lobster, Northern	76.76	NA	Raw
	76.03	0.358	Cooked, moist heat
Shrimp, mixed species	75.86	1.250	Raw
	72.56	1.421	Canned (dry pack or drained solids of wet pack)
	52.86	10.984	Cooked, breaded and fried
	77.28	0.926	Cooked, moist heat
Spiny Lobster, mixed species	74.07	1.102	Imitation made from surimi, raw
	81.82	0.456	Raw
Clam, mixed species	63.64	0.912	Canned, drained solids
	97.70	NA	Canned, liquid
	61.55	10.098	Cooked, breaded and fried
	63.64	0.912	Cooked, moist heat
	80.58	1.538	Raw
Mussel, Blue	61.15	3.076	Cooked, moist heat
	80.25	0.628	Raw
Octopus, common	85.14	1.620	Raw
	85.14	1.620	Canned (solids and liquid based) raw
Oyster, Eastern	64.72	11.212	Cooked, breaded and fried
	70.28	3.240	Cooked, moist heat
	82.06	1.752	Raw
Oyster, Pacific	78.57	0.377	Raw
	58.44	10.023	Cooked, breaded and fried
Scallop, mixed species	73.82	NA	Imitation, made from Surimi
	78.55	0.989	Raw
	64.54	6.763	Cooked, fried

<sup>a</sup> Data are reported as in the Handbook  
<sup>b</sup> Total Fat Content - saturated, monosaturated and polyunsaturated  
 NA = Not available

Source: USDA, 1979-1984 - U.S. Agricultural Handbook No. 8



Chapter 10 - Intake of Fish and Shellfish

Table 10-81. Recommendations - General Population		
Mean Intake (g/day)	95th Percentile of Long-term Intake Distribution (g/day)	Study (Reference)
	63 (Value of 42 from Javitz was adjusted upward by 50 percent to account for recent increase in fish consumption)	TRI (Javitz, 1980; Ruffle et al., 1994)
20.1 (Total Fish)		U.S. EPA Analysis of CSFII, 1989-91
14.1 (Marine Fish)		
6.0 (Freshwater/Estuarine Fish)		

Table 10-82. Recommendations - General Population - Fish Serving Size		
Mean Intake (grams)	95th Percentile (grams)	Study (Reference)
129	326	1989-1991 CSFII (U.S. EPA, 1996)

Table 10-83. Recommendations - Recreational Marine Anglers			
Mean Intake (g/day)	95th Percentile (g/day)	Study Location	Study
5.6	18.0	Atlantic	NMFS, 1993
7.2	26.0	Gulf	
2.0	6.8	Pacific	

Table 10-84. Recommendations - Freshwater Anglers			
Mean Intake (g/day)	Upper Percentile (g/day)	Study Location	Reference
5	13 (95th percentile)	Maine	Ebert et al., 1992
5	18 (95th percentile)	New York	Connelly et al., 1996
12	39 (96th percentile)	Michigan	West et al, 1989
17	---	Michigan	West et al, 1993



Table 10-85. Recommendations - Native American Subsistence Populations

Per-Capita (or Mean) Intake (g/day)	Upper Percentile (g/day)	Study Population	Reference
59	170 (95th)	4 Columbia River Tribes	CRITFC, 1994
16	---	94 Alaska Communities (Lowest of 94)	Wolfe and Walker, 1989
81	---	94 Alaska Communities (Median of 94)	Wolfe and Walker, 1989
770	---	94 Alaska Communities (Highest of 94)	Wolfe and Walker, 1989



Table 10-86. Summary of Fish Intake Studies

Source of Data (Reference)	Population Surveyed	Survey Time Period/Type	Analyses Performed (References)	Limitations/Advantages
<b>General Population</b>				
<b>Key Studies</b>				
Javitz, 1980 - TRI Survey	25,162 individuals - general population; the TRI Survey sample	Sept. 1973-Aug. 1974 (1 year survey). Completed diary over 1 month period on date of meal consumption, species of fish, packaging type, amount of fish prepared, number of servings consumed, etc.	Mean and distribution of fish consumption rates grouped by race, age, gender, census region, fish species, community type, and religion. Lognormal distribution fit to fish intake distribution by age and region by Ruffle et al. (1994).	High response rate (80%); population was large and geographically and seasonally representative; consumption rates based on one month of diary data; survey data is over 20 years out of date
U.S. EPA, 1996a	11,912 individuals - general population	Participants provided 3 consecutive days of dietary data. Three survey years (1989-1991) combined into one data set.	Analysis of CSFII 1989-91. Fish grouped by habitat (freshwater vs. marine) and type (finfish vs. shellfish). Per capita fish intake rates calculated using cooked and uncooked equivalent weight and reported in g/day and g/kg-day; also intake distribution per day eating fish.	Large, geographically representative study; relatively recent. Based on short-term (3 day) data so long-term percentiles of fish intake distribution could not be estimated.
<b>Relevant Studies</b>				
AIHC, 1994	--	--	Distributions using @Risk simulation software.	Limited reviews of supporting studies; good alternative source of information.
Pao et al., 1982	37,874 individuals - general population	Participants provided 3 consecutive days of dietary data. Survey conducted between April 1977 and March 1978.	Mean and distribution of average daily fish intake and average fish intake per eating occasion; by age-sex groups and overall.	Population was large and geographically representative; data were based on short-term dietary recall; data are almost 20 years out of date.
Tsang and Klepeis, 1996	9,386 individuals - general population	Participants provided 24-hour diary data. Follow-up questionnaires, survey conducted between October 1992 and September 1994.	Frequency of eating fish and number of servings per month provided.	Population large and geographically and seasonally balanced; data based on recall; intake data not provided.
USDA, 1992	10,000 individuals - general population	Participants provided 3 consecutive days of dietary data. Survey conducted between April 1987 and March 1988.	Per capita fish intake rates and percent of population consuming fish in one day; by age and sex.	Population was large and geographically and seasonally balanced; data based on short-term dietary recall.



Table 10-86. Summary of Fish Intake Studies (continued)

Source of Data (Reference)	Population Surveved	Survey Time Period/Type	Analyses Performed (References)	Limitations/Advantages
<b>Recreational-Marine Fish</b>				
<b>Key Study</b>				
NMFS 1986a, b, c; 1993	Atlantic and Gulf Coasts - 41,000 field interviews and 58,000 telephone interviews; Pacific Coast - 38,000 field interviews and 73,000 telephone interviews.	Telephone interviews with residents of coastal counties; information on fishing frequency and mode of fishing trips. Field interviews with marine anglers; information on area and mode fished, fishing frequency, species caught, weight of fish, and whether fish were intended to be consumed.	Intake rates were not calculated; total catch size grouped by marine species, seasons, and number of fishermen for each coastal region were presented.	Population was large geographically and seasonally balanced; fish caught were weighed in the field. No information on number of potential consumers of catch.
<b>Relevant Studies</b>				
Pierce et al., 1981	~500 anglers in Commencement Bay, Washington	July-November 1980; creel survey interviews conducted consisting of 5 summer days and 4 fall days.	Distribution of fishing frequency; total weight of catch grouped by species. Re-analysis by Price et al. (1994) using inverse fishing frequency as sample weights.	Local survey. Original analysis by Pierce et al. (1981) did not calculate intake rates; analysis over-estimated fishing frequency distribution by oversampling frequent anglers. Re-analysis by Price et al. (1994) involved several assumptions; thus results are questionable.
Puffer et al., 1981	1,067 anglers in the Los Angeles, California area.	Creel survey conducted for the full 1980 calendar year.	Distribution of sport fish intake rates. Median rates by age, ethnicity and fish species. Re-analysis by Price et al. (1994) using inverse fishing frequency as sample weights.	Local survey. Original (unweighted) analysis over-estimated fish intake by oversampling frequent anglers. Re-analysis by Price et al. (1994) involves several assumptions; thus results are questionable.
U.S. DHHS, 1995	330 everglade residents/ subsistence fishermen or both	1992-1993; questionnaire with demographic information and fishing and eating habits.	Provides data for fishing frequency by sex, age, and ethnicity.	Intake rates were not reported, study not representative of the U.S. population; one of few studies that target subsistence fishermen.



Table 10-86. Summary of Fish Intake Studies (continued)

Source of Data (Reference)	Population Surveyed	Survey Time Period/Type	Analyses Performed (References)	Limitations/Advantages
<b>Recreational Fresh Water Fish</b>				
<b>Key Studies</b>				
Chemnick, 1991; Ebert et al., 1993	1,612 licensed Maine anglers	1989-1990 ice fishing season and 1990 open water season; mailed survey; one year recall of frequency of fishing trips, number and length of fish species caught.	Mean and distribution of fish consumption rates by ethnic groups and overall. Mean and distribution of fish consumption rates for fish from rivers and streams. EPA analysis of fish intake for household members.	Data based on one year recall; high response rate; area-specific consumption patterns.
Connelly et al., 1996	825 anglers with NY State fishing licenses intending to fish Lake Ontario.	Survey consisted of self-recording information in a diary for 1992 fishing trips and fish consumption.	Distribution of intake rates of sport caught fish.	Meal size estimated by comparison with pictures of 8 oz. fish meals.
West et al., 1993	2,681 persons with Michigan fishing licenses	January 1991 through January 1992; mailed survey, 7-day recall; demographics information requested, and quantity of fish eaten, if any, at each meal based on a photograph of 1/2 lb of fish (more about same, or less).	Mean consumption rate for sport and total fish by demographic category (West et al., 1993) and 50th, 90th, and 95th percentile (U.S. EPA, 1995).	Relatively low response made and only three categories were used to assign fish portion size. Relatively large-scale study and reliance on short-term recall.
West et al., 1989	1,171 Michigan residents with fishing licenses	January-May 1988; anglers completed questionnaires based on 7-day and 1-year recall.	Mean intake rates of self-caught fish based on 7-day recall period and mean and percentiles of self-caught fish intake based on one year recall.	Weight of fish consumed was estimated using a picture of an 8 oz. fish meal; smaller meals were judged to be 5 oz., larger ones 10 oz.
<b>Relevant Studies</b>				
Connelly et al., 1992	1,030 anglers licensed in New York	Survey mailed out in Jan. 1992; one year recall of the period Oct. 1990-Sept. 1991	Knowledge and effects of fish health advisories. Mean number of sport-caught fish meals.	Response rate of 52.8%; only number of fish meals reported.
Fiore et al., 1989	801 individuals with Wisconsin fish or sporting licenses	1985 summer; mailed survey; one year recall of sport fish consumption.	Mean number of sport caught fish meals of Wisconsin anglers.	Constant meal size assumed.
Hudson River Sloop Clearwater, Inc. (1993)	336 shore-based anglers	Survey conducted June-November 1991; April-July 1992. Onsite interview with anglers.	Knowledge and adherence to health advisories	Data collected from personal interviews; intake data not provided; fish meal data provided.





Table 10-86. Summary of Fish Intake Studies (continued)

Source of Data (Reference)	Population Surveyed	Survey Time Period/Type	Analyses Performed (References)	Limitations/Advantages
<b>Native American</b>				
<b>Key Studies</b>				
CRITFC, 1994	Four tribes in Washington state; total of 513 adults and 204 children under five	Fall and Winter of 1991-1992; stratified random sampling approach; in-person interviews; information requested included 24-hour dietary recall, seasonal and annual number of fish meals, average weight of fish meals and species consumed.	Mean and distribution of fish intake rates for adults and for children. Mean intake rates by age and gender. Frequency of cooking and preparation methods.	Survey was done at only one time of the year and involved one year recall; fish intake rates were based on all fish sources but great majority was locally caught; study provides consumption and habits for subsistence subpopulation group.
Fitzgerald et al. 1995	97 Mohawk women in New York; 154 Caucasian women; nursing mothers	1988-1992, up to 3-year recall	Mean number of sport-caught fish meals per year.	Survey for nursing mothers only, recall for up to 3 years; small sample size; may be representative of Mohawk women; measured in fish meals.
Petersen et al., 1994	327 residents of Chippewa reservation, Wisconsin	Self-administered questionnaire completed in May, 1990.	Mean number of fish meals per year.	Did not distinguish between commercial and sport-caught meals.
Wolfe and Walker, 1987	Ninety-eight communities in Alaska surveyed by various researchers	Surveys conducted between 1980 and 1985; data based on 1-year recall period. Annual per capita harvest of fish, land mammals, marine mammals and other resources estimated for each community.	Distribution among communities of annual per-capita harvests for each resource category.	Data based on 1-year recall; data provided are harvest data that must be converted to individual intake rates; surveyed communities are only a sample of all Alaska communities.

<sup>a</sup> NFMS - National Marine Fisheries Services.



Table 10-87. Confidence in Fish Intake Recommendations for General Population

Considerations	Rationale	Rating
<b>Study Elements</b>		
• Level of peer review	Peer reviewed by USDA and EPA.	High
• Accessibility	CSFII data are publicly available. Javitz is a contractor report to EPA.	High (CSFII) Medium (Javitz)
• Reproducibility	Enough information is available to reproduce results.	High
• Focus on factor of interest	The studies focused on fish ingestion.	High
• Data pertinent to U.S.	The studies were conducted for U.S. population.	High
• Primary data	The studies are primary studies.	High
• Currency	Studies were conducted from 1973-1974 to 1989-1991.	Medium (mean) Low (Long-Term Distribution)
• Adequacy of data collection period	Long-term distribution are based on one month data collection period.	High (Mean) Medium (Long-term distribution)
• Validity of approach	Data are collected using diaries and one-day recall. However, data adjusted to account for changes in eating pattern.	Medium
• Study size	The Range of samples was 10,000 -37,000.	High
• Representativeness of the population	The data are representative of overall U.S. population.	High
• Characterization of variability	Long-term distribution (generated from 1973-1974 data) was shifted upward based on recent increase in mean consumption.	Medium
• Lack of bias in study design (high rating is desirable)	Response rates were fairly high; there was no obvious source of bias.	High
• Measurement error	Estimates of intake amounts were imprecise.	Medium
<b>Other Elements</b>		
• Number of studies	There was 1 study for the mean, the results of 2 studies were utilized for long-term distribution.	Low
• Agreement between researchers		Medium
<b>Overall Rating</b>		Medium (Mean) Low (Long-term distribution)



Table 10-88. Confidence in Fish Intake Recommendations for Recreational Marine Anglers

Considerations	Rationale	Rating
<b>Study Elements</b>		
• Level of peer review	Data were reviewed by NMFS and EPA.	High
• Accessibility	The analysis of the NMFS data is presented in the Handbook and NMFS data can be found in NMFS publications.	High
• Reproducibility	Enough information is available to reproduce results.	High
• Focus on factor of interest	Studies focused on fish catch rather than fish consumption per se.	Medium
• Data pertinent to U.S.	The studies were conducted in the U.S.	High
• Primary data	Data are from primary studies.	High
• Currency	The data were based on 1993 studies.	High
• Adequacy of data collection period	Data were collected once for each angler. The yearly catch of anglers were estimated from catch on intercepted trip and reported fishing frequency.	Medium
• Validity of approach	The creel survey provided data on fishing frequency and fish weight; telephone survey data provided number of anglers. An average value was used for the number of intended fish consumers and edible fraction.	Medium
• Study size	Studies encompassed a population of over 100,000.	High
• Representativeness of the population	Data were representative of overall U.S. coastal state population.	High
• Characterization of variability	Distributions were generated.	High
• Lack of bias in study design (high rating is desirable)	Response rates were fairly high; There was no obvious source of bias.	High
• Measurement error	Fish were weighed in the field.	High
<b>Other Elements</b>		
• Number of studies	There was 1 study.	Low
• Agreement between researchers	N/A	
<b>Overall Rating</b>		Medium



Table 10-89. Confidence in Recommendations for Fish Consumption - Recreational Freshwater		
Considerations	Rationale	Rating
<b>Study Elements</b>		
• Level of peer review	Studies can be found in peer reviewed journals and has been reviewed by the EPA.	High
• Accessibility	The original study analyses are reported in accessible journals. Subsequent EPA analyses are detailed in Handbook.	High
• Reproducibility	Enough information is available to reproduce results.	High
• Focus on factor of interest	Studies focused on ingestion of fish by the recreational freshwater angler.	High
• Data pertinent to U.S.	The studies were conducted in the U.S.	High
• Primary data	Data are from primary references.	High
• Currency	Studies were conducted between 1988-1992.	High
• Adequacy of data collection period	Data were collected for one year period for 3 studies; and a one week period for one study.	High
• Validity of approach	Data presented are as follows: one year recall of fishing trips (2 studies), one week recall of fish consumption (1 study), and one year diary survey (1 study). Weight of fish consumed was estimated using approximate weight of fish catch and edible fraction or approximate weight of fish meal.	Medium
• Study size	Study population ranged from 800-2600.	High
• Representativeness of the population	Each study was localized to a single state or area.	Low
• Characterization of variability	Distributions were generated.	High
• Lack of bias in study design (high rating is desirable)	Response rates were fairly high. One year recall of fishing trips may result in overestimate.	Medium
• Measurement error	Weight of fish portions were estimated in one study, fish weight was estimated from reported fish length in another study.	Medium
<b>Other Elements</b>		
• Number of studies	There are 4 key studies.	High
• Agreement between researchers	Intake rates in different parts of country may be expected to show some variation.	Medium
<b>Overall Rating</b>	The main drawback is that studies are not nationally representative and not representative of long-term consumption.	Medium



Table 10-90. Confidence in Recommendations for Native American Subsistence Fish Consumption

Considerations	Rationale	Rating
<b>Study Elements</b>		
• Level of peer review	Studies are from peer reviewed journal (1 study), and technical reports (1study).	Medium
• Accessibility	Journal articles are publicly available. CRITFC is a technical report.	Medium
• Reproducibility	The studies were adequately detailed.	High
• Focus on factor of interest	Studies focused on fish ingestion and fish harvest.	High
• Data pertinent to U.S.	All studies were specific to area in the U.S.	High
• Primary data	One study used primary data, the other used secondary data.	Medium
• Currency	Data were from early 1980's to 1992.	Medium
• Adequacy of data collection period	Data collected for one year period.	High
• Validity of approach	One study used fish harvest data; EPA used a factor to convert to individual intake. Other study measured individual intake directly.	Medium
• Study size	The sample population was 500 for the study with primary data.	Medium
• Representativeness of the population	Only two states were represented.	Low
• Characterization of variability	Individual variation were not described in summary study.	Medium
• Lack of bias in study design (high rating is desirable)	The response rate was 69% in study with primary data. Bias was hard to evaluate in summary study.	Medium
• Measurement error	The weight of the fish was estimated.	Medium
<b>Other Elements</b>		
• Number of studies	There were two studies; only one study described individual variation in intake.	Medium
• Agreement between researchers	Range of per-capita rates from summary study includes per-capita rate from study with primary data.	High
<b>Overall Rating</b>	Studies are not nationally representative. Upper percentiles are based on only one study.	Medium (per capita intake) Low (upper percentiles)



**APPENDIX 10A**

**RESOURCE UTILIZATION DISTRIBUTION**



**Appendix 10A. Resource Utilization Distribution**

The percentiles of the resource utilization distribution of Y are to be distinguished from the percentiles of the (standard) distribution of Y. The latter percentiles show what percentage of individuals in the population are consuming below a given level. Thus, the 50th percentile of the distribution of Y is that level such that 50 percent of individuals consume below it; on the other hand, the 50th percentile of the resource utilization distribution is that level such that 50 percent of the overall consumption in the population is done by individuals consuming below it.

The percentiles of the resource utilization distribution of Y will always be greater than or equal to the corresponding percentiles of the (standard) distribution of Y, and, in the case of recreational fish consumption, usually considerably exceed the standard percentiles.

To generate the resource utilization distribution, one simply weights each observation in the data set by the Y level for that observation and performs a standard percentile analysis of weighted data. If the data already have weights, then one multiplies the original weights by the Y level for that observation, and then performs the percentile analysis.

Under certain assumptions, the resource utilization percentiles of fish consumption may be related (approximately) to the (standard) percentiles of fish consumption derived from the analysis of creel studies. In this instance, it is assumed that the creel survey data analysis did not employ sampling weights (i.e., weights were implicitly set to one); this is the case for many of the published analyses of creel survey data. In creel studies the fish consumption rate for the  $i$ th individual is usually derived by multiplying the amount of fish consumption per fishing trip (say  $C_i$ ) by the frequency of fishing (say  $f_i$ ). If it is assumed that the probability of sampling of an angler is proportional to fishing frequency, then sampling weights of inverse fishing frequency ( $1/f_i$ ) should be employed in the analysis of the survey data. Above it was stated that for data that are already weighted the resource utilization distribution is generated by multiplying the original weights by the individual's fish consumption level to create new weights. Thus, to generate the resource utilization distribution from the data with weights of ( $1/f_i$ ), one multiplies ( $1/f_i$ ) by the fish consumption level of  $f_i C_i$  to get new weights of  $C_i$ .

Now if  $C_i$  (amount of consumption per fishing trip) is constant over the population, then these new weights are constant and can be taken to be one. But weights of one is what (it is assumed) were used in the original creel survey data analysis. Hence, the resource utilization distribution is exactly the same as the original (standard) distribution derived from the creel survey using constant weights.

The accuracy of this approximation of the resource utilization distribution of fish by the (standard) distribution of fish consumption derived from an unweighted analysis of creel survey data depends then on two factors, how approximately constant the  $C_i$ 's are in the population and how approximately proportional the relationship between sampling probability and fishing frequency is. Sampling probability will be roughly proportional to frequency if repeated sampling at the same site is limited or if re-interviewing is performed independent of past interviewing status.

Note: For any quantity Y that is consumed by individuals in a population, the percentiles of the "resource utilization distribution" of Y can be formally defined as follows:  $Y_p(R)$  is the  $p$ th percentile of the resource utilization distribution if  $p$  percent of the overall consumption of Y in the population is done by individuals with consumption below  $Y_p(R)$  and 100- $p$  percent is done by individuals with consumption above  $Y_p(R)$ .



**APPENDIX 10B**

**FISH PREPARATION AND COOKING METHODS**





Appendix 10B

Residence Size	Large City/Suburb	Small City	Town	Small Town	Rural Non-Farm	Farm
<b>Total Fish</b>						
<u>Cooking Method</u>						
Pan Fried	32.7	31.0	36.0	32.4	38.6	51.6
Deep Fried	19.6	24.0	23.3	24.7	26.2	15.7
Boiled	6.0	3.0	3.4	3.7	3.4	3.5
Grilled/Broiled	23.6	20.8	13.8	21.4	13.7	13.1
Baked	12.4	12.4	10.0	10.3	12.7	6.4
Combination	2.5	6.0	8.3	5.0	2.3	7.0
Other (Smoked, etc.)	3.2	2.8	5.2	1.9	2.9	1.8
Don't Know	0.0000	0.0000	0.0000	0.5	0.2	--
Total (N) <sup>b</sup>	393	317	388	256	483	94
<b>Sport Fish</b>						
Pan Fried	45.8	45.7	47.6	41.4	51.2	63.3
Deep Fried	12.2	14.5	17.5	15.2	21.9	7.3
Boiled	2.8	2.3	2.9	0.5	3.6	0
Grilled/Broiled	20.2	17.6	10.6	25.3	8.2	10.4
Baked	11.8	8.8	6.3	8.7	9.7	6.9
Combination	2.7	8.5	10.4	6.7	1.9	9.3
Other (smoked, etc.)	4.5	2.7	4.9	1.5	3.5	2.8
Don't Know	0	0	0	0.7	0	0
Total (N)	205	171	257	176	314	62

<sup>a</sup> Large City = over 100,000; Small City = 20,000-100,000; Town = 2,000-20,000; Small Town = 100-2,000.  
<sup>b</sup> N = Total number of respondents  
 Source: West et al., 1993.

Age (years)	17-30	31-40	41-50	51-64	>64	Overall
<b>Total Fish</b>						
<u>Cooking Method</u>						
Pan Fried	45.9	31.7	30.5	33.9	40.7	35.3
Deep Fried	23.0	24.7	26.9	23.7	14.0	23.5
Boiled	0.0000	6.0	3.6	3.9	4.3	3.9
Grilled or Boiled	15.6	15.2	24.3	16.1	18.8	17.8
Baked	10.8	13.0	8.7	12.8	11.5	11.4
Combination	3.1	5.2	2.2	6.5	6.8	4.7
Other (Smoked, etc.)	1.6	4.2	3.5	2.7	4.0	3.2
Don't Know	0.0000	0.0000	0.3	0.4	0.0000	0.2
Total (N) <sup>a</sup>	246	448	417	502	287	1946
<b>Sport Fish</b>						
Pan Fried	57.6	42.6	43.4	46.6	54.1	47.9
Deep Fried	18.2	21.0	17.3	14.8	7.7	16.5
Boiled	0.0000	4.4	0.8	3.2	3.1	2.4
Grilled/Broiled	15.0	10.1	25.9	12.2	12.2	14.8
Baked	3.6	10.4	6.4	11.7	9.9	8.9
Combination	3.8	7.2	3.0	7.5	8.2	5.9
Other (Smoked, etc.)	1.7	4.3	3.2	3.5	4.8	3.5
Don't Know	0.0000	0.0000	0.0000	0.4	0.0000	0.1
Total (N)	174	287	246	294	163	1187

<sup>a</sup> N = Total number of respondents.  
 Source: West et al., 1993.



Table 10B-3. Percent of Fish Meals Prepared Using Various Cooking Methods by Ethnicity

Ethnicity	Black	Native American	Hispanic	White	Other
<b>Total Fish</b>					
<u>Cooking Method</u>					
Pan Fried	40.5	37.5	16.1	35.8	18.5
Deep Fried	27.0	22.0	83.9	22.7	18.4
Boiled	0	1.1	0	4.3	0
Grilled/Broiled	19.4	9.8	0	17.7	57.6
Baked	1.9	16.3	0	11.7	5.4
Combination	9.5	6.2	0	4.5	0
Other (Smoked, etc.)	1.6	4.2	3.5	2.7	4.0
Don't Know	0	0	0.3	0.4	0
Total (N) <sup>a</sup>	52	84	12	1,744	33
<b>Sport Fish</b>					
Pan Fried	44.9	47.9	52.1	48.8	22.0
Deep Fried	36.2	20.2	47.9	15.7	9.6
Boiled	0	0	0	2.7	0
Grilled/Broiled	0	1.5	0	14.7	61.9
Baked	5.3	18.2	0	8.6	6.4
Combination	13.6	8.6	0	5.6	0
Other (Smoked, etc.)	0	3.6	0	3.7	0
Total (N)	19	60	4	39	0

<sup>a</sup> N = Total number of respondents.  
Source: West et al., 1993.

Table 10B-4. Percent of Fish Meals Prepared Using Various Cooking Methods by Education

Education	Through Some H.S.	H.S. Degree	College Degree	Post Graduate Education
<b>Total Fish</b>				
<u>Cooking Method</u>				
Pan Fried	44.7	41.8	28.8	22.9
Deep Fried	23.6	23.6	23.8	19.4
Boiled	2.2	2.8	5.1	5.8
Grilled/Broiled	8.9	10.9	23.8	34.1
Baked	8.1	12.1	11.6	12.8
Combination	10.0	5.1	3.0	3.8
Other (Smoked, etc.)	2.1	3.4	4.0	1.3
Don't Know	0.5	0.3	0	0
Total (N) <sup>a</sup>	236	775	704	211
<b>Sport Fish</b>				
Pan Fried	56.1	52.4	41.8	36.3
Deep Fried	13.6	15.8	18.6	12.9
Boiled	2.8	2.4	3.0	0
Grilled/Baked	6.3	9.4	21.7	28.3
Baked	7.4	10.6	6.1	14.9
Combination	10.1	6.3	3.9	6.5
Other (Smoked, etc.)	2.8	3.3	4.6	1.0
Don't Know	0.8	0	0	0
Total (N)	146	524	421	91

<sup>a</sup> N = Total number of respondents.  
Source: West et al., 1993.



*Appendix 10B*

Table 10B-5. Percent of Fish Meals Prepared Using Various Cooking Methods by Income			
Income	0 - \$24,999	\$25,000 - \$39,999	\$40,000 - or more
<b>Total Fish</b>			
<u>Cooking Method</u>			
Pan Fried	44.8	39.1	26.5
Deep Fried	21.7	22.2	23.4
Boiled	2.1	3.5	5.6
Grilled/Broiled	11.3	15.8	25.0
Baked	9.1	12.3	13.3
Combination	8.7	2.9	2.5
Other (Smoked, etc.)	2.4	4.0	3.5
Don't Know	0	0.2	0.3
Total (N) <sup>a</sup>	544	518	714
<b>Sport Fish</b>			
Pan Fried	51.5	51.4	42.0
Deep Fried	15.8	15.8	17.2
Boiled	1.8	2.1	3.7
Grilled/Broiled	12.0	12.2	19.4
Baked	7.2	10.0	10.0
Combination	9.1	3.8	3.5
Other (Smoked, etc.)	2.7	4.6	3.8
Don't Know	0	0	0.3
Total (N)	387	344	369
<sup>a</sup> N = Total number of respondents. Source: West et al., 1993.			



Table 10B-6. Percent of Fish Meals Where Fat was Trimmed or Skin was Removed, by Demographic Variables

Population	Total Fish		Sport Fish	
	Trimmed Fat (%)	Skin Off (%)	Trimmed Fat (%)	Skin Off (%)
<u>Residence Size</u>				
Large City/Suburb	51.7	31.6	56.7	28.9
Small City	56.9	34.1	59.3	36.2
Town	50.3	33.4	51.7	33.7
Small Town	52.6	45.2	55.8	51.3
Rural Non-Farm	42.4	32.4	46.2	34.6
Farm	37.3	38.1	39.4	42.1
<u>Age (years)</u>				
17-30	50.6	36.5	53.9	39.3
31-40	49.7	29.7	51.6	29.9
41-50	53.0	32.2	58.8	37.0
51-65	48.1	35.6	48.8	37.2
Over 65	41.6	43.1	43.0	42.9
<u>Ethnicity</u>				
Black	25.8	37.1	16.0	40.1
Native American	50.0	41.4	56.3	36.7
Hispanic	59.5	7.1	50.0	23.0
White	49.3	34.0	51.8	35.6
Other	77.1	61.6	75.7	65.5
<u>Education</u>				
Some High School	50.8	43.9	49.7	47.1
High School Degree	47.2	37.1	49.5	37.6
College Degree	51.9	31.9	55.9	33.8
Post-Graduate	47.6	26.6	53.4	38.7
<u>Income</u>				
<\$25,000	50.5	43.8	50.6	47.3
\$25-39,999	47.8	34.0	54.9	34.6
\$40,000 or more	50.2	28.6	51.7	27.7
Overall	49.0	34.7	52.1	36.5

Source: Modified from West et. al., 1993.



Appendix 10B

Table 10B-7. Method of Cooking of Most Common Species Kept by Sportfishermen						
Species	Percent of Anglers Catching Species	Use as Primary Cooking Method (Percent)				
		Deep Fry	Pan Fry	Bake and Charcoal Broil	Raw	Other <sup>b</sup>
White Croaker	34%	19%	64%	12%	0%	5%
Pacific Mackerel	25%	10%	41%	28%	0%	21%
Pacific Bonito	18%	5%	33%	43%	2%	17%
Queenfish	17%	15%	70%	6%	1%	8%
Jacksmelt	13%	17%	57%	19%	0%	7%
Walleye Perch	10%	12%	69%	6%	0%	13%
Shiner Perch	7%	11%	72%	8%	0%	11%
Opaleye	6%	16%	56%	14%	0%	14%
Black Perch	5%	18%	53%	14%	0%	15%
Kelp Bass	5%	12%	55%	21%	0%	12%
California Halibut	4%	13%	60%	24%	0%	3%
Shellfish <sup>a</sup>	3%	0%	0%	0%	0%	100%

(n = 1059)  
<sup>a</sup> Crab, mussels, lobster, abalone  
<sup>b</sup> Boil, soup, steam, stew  
 Source: Modified from Puffer et al., 1981.

Table 10B-8. Adult Consumption of Fish Parts							
Species	Number Consuming	Weighted Percent Consuming Specific Parts					
		Fillet	Skin	Head	Eggs	Bones	Organs
Salmon	473	95.1%	55.8%	42.7%	42.8%	12.1%	3.7%
Lamprey	249	86.4%	89.3%	18.1%	4.6%	5.2%	3.2%
Trout	365	89.4%	68.5%	13.7%	8.7%	7.1%	2.3%
Smelt	209	78.8%	88.9%	37.4%	46.4%	28.4%	27.9%
Whitefish	125	93.8%	53.8%	15.4%	20.6%	6.0%	0.0%
Sturgeon	121	94.6%	18.2%	6.2%	11.9%	2.6%	0.3%
Walleye	46	100%	20.7%	6.2%	9.8%	2.4%	0.9%
Squawfish	15	89.7%	34.1%	8.1%	11.1%	5.9%	0.0%
Sucker	42	89.3%	50.0%	19.4%	30.4%	9.8%	2.1%
Shad	16	93.5%	15.7%	0.0%	0.0%	3.3%	0.0%

Source: CRITFC, 1994.



**APPENDIX 10C**

**PER CAPITA ESTIMATES BY SPECIES  
BASED ON THE USDA CSFII DATA**

Table 10C-1. Daily Average Per Capita Estimates of Fish Consumption U.S. Population - Mean Consumption by Species Within Habitat - As Consumed Fish									
Habitat	Species	Estimated Mean Grams/Person/Day	Habitat	Species	Estimated Mean Grams/Person/Day	Habitat	Species	Estimated Mean Grams/Person/Day	
Estuarine	Shrimp	1.37241	Marine (Cont)	Swordfish	0.13879	All Species (Cont)	Flounder	0.24590	
	Perch	0.52580		Squid	0.12196		Scallop (Marine)	0.21805	
	Flatfish (Estuarine)	0.43485		Sardine	0.10013		Sea Bass	0.20794	
	Crab (Estuarine)	0.29086		Pompano	0.09131		Lobster	0.20001	
	Flounder	0.24590		Sole	0.07396		Oyster	0.17840	
	Oyster	0.17840		Mackerel	0.06379		Clam (Estuarine)	0.14605	
	Clam (Estuarine)	0.14605		Whiting	0.05498		Swordfish	0.13879	
	Mullet	0.07089		Halibut	0.02463		Squid	0.12196	
	Croaker	0.05021		Mussels	0.02217		Sardine	0.10313	
	Herring	0.02937		Shark	0.01901		Pompano	0.09131	
	Smelts	0.02768		Whitefish	0.00916		Sole	0.07396	
	Scallop (Estuarine)	0.00247		Seafood	0.00574		Mullet	0.07089	
	Anchovy	0.00228		Snapper	0.00539		Mackarel	0.06379	
	Scup	0.00050		Octopus	0.00375		Whiting	0.05498	
Sturgeon	0.00040	Barracuda	0.00111	Croaker	0.05021				
Freshwater	Catfish	1.06776	Unknown	Fish	0.00186	All Species	Carp	0.04846	
	Trout	0.43050		Tuna	Tuna		4.19998	Herring	0.02937
	Carp	0.04846			Clam (Marine)		1.66153	Smelts	0.02768
	Pike	0.01978			Shrimp		1.38883	Halibut	0.02463
	Salmon (Freshwater)	0.00881			Cod		1.22827	Mussels	0.02217
		Catfish	1.06776		Pike		0.01978		
Marine	Tuna	4.19998	All Species		Shrimp		1.38883	Shark	0.01901
	Clam (Marine)	1.66153			Cod		1.22827	Whitefish	0.00916
	Cod	1.22627			Catfish		1.06776	Salmon (Freshwater)	0.00881
	Flatfish (Marine)	1.06307			Faltfish (Marine)		1.06307	Seafood	0.00574
	Salmon (Marine)	0.73778			Salmon (Marine)		0.73778	Snapper	0.00539
	Haddock	0.51533			Perch		0.52580	Octopus	0.00375
	Pollock	0.44970			Haddock		0.51533	Scallop (Estuarine)	0.00247
	Crab (Marine)	0.33870			Pollock		0.44970	Anchovy	0.00228
	Ocean Perch	0.31878			Flatfish (Estuarine)	0.43485	Fish	0.00166	
	Porgy	0.29844		Trout	0.43050	Barracuda	0.00111		
	Scallop (Marine)	0.21805		Crab (Marine)	0.33870	Abalone	0.00075		
	Sea Bass	0.20794		Ocean Perch	0.31878	Scup	0.00050		
	Lobster	0.20001		Porgy	0.29844	Sturgeon	0.00040		
				Crab (Estuarine)	0.29088				

Notes: Estimates are projected from a sample of 11,912 individuals to the U.S. population of 242,707,000 using 3-year combined survey weights. The population for this survey consisted of individuals in the 48 conterminous states.

Source of individual consumption data: USDA Combined 1989, 1990, and 1991 Continuing Survey of Food Intakes by Individuals (CSFII).

The fish component of foods containing fish was calculated using data from the recipe file for release 7 of the USDA's Nutrient Data Base for Individual Food Intake Surveys.





Table 10C-2. Daily Average Per Capita Estimates of Fish Consumption  
U.S. Population - Mean Consumption by Species Within Habitat - Uncooked Fish

Habitat	Species	Estimated Mean Grams/Person/Day	Habitat	Species	Estimated Mean Grams/Person/Day	Habitat	Species	Estimated Mean Grams/Person/Day
Estuarine	Shrimp	1.78619	Marine (Cont)	Swordfish	0.17903	All Species (Cont)	Flounder	0.28559
	Perch	0.66494		Squid	0.14420		Lobster	0.27563
	Flatfish (Estuarine)	0.50832		Sardine	0.13750		Sea Bass	0.26661
	Crab (Estuarine)	0.40848		Pompano	0.12160		Scallop (Marine)	0.26199
	Flounder	0.28559		Mackerel	0.09866		Oyster	0.18827
	Oyster	0.18827		Sole	0.08339		Swordfish	0.17903
	Mullet	0.08959		Whiting	0.06514		Squid	0.14420
	Croaker	0.06539		Mussels	0.03718		Sardine	0.13750
	Smelts	0.03470		Halibut	0.03030		Pompano	0.12160
	Herring	0.03408		Shark	0.02385		Mackarel	0.09866
	Clam (Estuarine)	0.03339		Whitefish	0.00916		Mullet	0.08958
	Anchovy	0.00304		Snapper	0.00551		Sole	0.08339
	Scallop (Estuarine)	0.00297		Octopus	0.00457		Croaker	0.06539
	Scup	0.00050		Barracuda	0.00130		Whiting	0.06514
Sturgeon	0.00040	Abalone	0.00094	Carp	0.06012			
Freshwater	Catfish	1.38715	Unknown	Seafood	0.00043	Mussels	0.03718	
	Trout	0.53777		Fish	0.00248	Smelts	0.03470	
	Carp	0.06012		All Species	Tuna	5.67438	Herring	0.03406
	Pike	0.02244			Shrimp	1.78619	Clam (Estuarine)	0.03339
	Salmon (Freshwater)	0.01183			Cod	1.47609	Halibut	0.03030
		Catfish	1.38715		Shark	0.02385		
		Flatfish (Marine)	1.24268		Pike	0.02244		
Marine	Tuna	5.67438		Salmon (Marine)	0.99093	Salmon (Freshwater)	0.01183	
	Cod	1.47609		Perch	0.66494	Whitefish	0.00916	
	Flatfish (Marine)	1.24268		Haddock	0.62219	Snapper	0.00551	
	Salmon (Marine)	0.99093		Trout	0.53777	Octopus	0.00457	
	Haddock	0.62219		Pollock	0.52906	Anchovy	0.00304	
	Pollock	0.52906		Flatfish (Estuarine)	0.50832	Scallop (Estuarine)	0.00297	
	Crab (Marine)	0.47567		Crab (Marine)	0.47567	Fish	0.00248	
	Porgy	0.42587		Porgy	0.42587	Barracuda	0.00130	
	Ocean Perch	0.39327		Crab (Estuarine)	0.40848	Abalone	0.00094	
	Clam (Marine)	0.37982		Ocean Perch	0.39327	Scup	0.00050	
	Lobster	0.27583		Clam (Marine)	0.37982	Seafood	0.00043	
	Sea Bass	0.26661				Sturgeon	0.00040	
	Scallop (Marine)	0.26199						

Notes: Estimates are projected from a sample of 11,912 individuals to the U.S. population of 242,707,000 using 3-year combined survey weights. The population for this survey consisted of individuals in the 48 contiguous states.

Source of individual consumption data: USDA Combined 1989, 1990, and 1991 Continuing Survey of Food Intakes by Individuals (CSFII).

Amount of consumed fish recorded by survey respondents was converted to uncooked fish quantities using data from the recipe file for release 7 of USDA's Nutrient Data Base for Individual Food Intake Surveys. The fish component of foods containing fish was calculated using data from the recipe file for release 7 of the USDA's Nutrient Data Base for Individual Food Intake Surveys.





Table 10C-3. Daily Average Per Capita Estimates Of Fish Consumption  
As Consumed Fish - Mean Consumption by Species Within Habitat  
U.S. Population

Habitat	Species	Estimated Mean Grams/person/day	Habitat	Species	Estimated Mean Grams/person/day	Habitat	Species	Estimated Mean Grams/person/day
Estuarine	Shrimp	1.37241	Marine (Con't.)	Swordfish	0.13879	All Species (Con't.)	Flounder	0.24590
	Perch	0.52580		Squid	0.12196		Scallop (Marine)	0.21805
	Flatfish	0.43485		Sardine	0.10313		Sea Bass	0.20794
	Crab	0.29086		Pompano	0.09131		Lobster	0.20001
	Flounder	0.24590		Sole	0.07396		Oyster	0.17419
	Oyster	0.17419		Mackerel	0.06379		Swordfish	0.13879
	Mullet	0.07089		Whiting	0.05498		Squid	0.12196
	Croaker	0.05021		Halibut	0.02463		Sardine	0.10313
	Herring	0.02937		Mussels	0.02217		Pompano	0.09131
	Freshwater	Smelts		0.02768	Unknown		Shark	0.01901
Clam		0.02691	Whitefish	0.00916		Mullet	0.07089	
Scallop		0.00247	Snapper	0.00539		Mackerel	0.06379	
Anchovy		0.00228	Octopus	0.00375		Whiting	0.05498	
Scup		0.00050	Barracuda	0.00111		Croaker	0.05021	
Sturgeon		0.00040	Abalone	0.00075		Carp	0.04846	
Catfish		1.06776	Seafood	0.00043		Herring	0.02937	
Trout		0.43050	Fish	0.00186		Smelts	0.02768	
Carp		0.04846	Tuna	4.19998		Clam (Estuarine)	0.02691	
Pike		0.01978	Shrimp	1.37241		Halibut	0.02463	
Marine	Salmon	0.00881	Cod	1.22827	Mussels	0.02217		
	Tuna	4.19998	Catfish	1.06776	Pike	0.01978		
	Cod	1.22827	Flatfish (Marine)	1.06307	Shark	0.01901		
	Flatfish	1.06307	Salmon (Marine)	0.73778	Whitefish	0.00916		
	Salmon	0.73778	Perch	0.52580	Salmon (Freshwater)	0.00539		
	Haddock	0.51533	Haddock	0.51533	Snapper	0.00375		
	Pollock	0.44970	Pollock	0.44970	Octopus	0.00247		
	Crab	0.33870	Flatfish (Estuarine)	0.43485	Scallop (Estuarine)	0.00228		
	Ocean Perch	0.31878	Trout	0.43050	Anchovy	0.00186		
	Clam	0.30617	Crab (Marine)	0.33870	Fish	0.00111		
Porgy	0.29844	Ocean Perch	0.31878	Barracuda	0.00075			
Scallop	0.21805	Clam (Marine)	0.30617	Abalone	0.00050			
Sea Bass	0.20794	Porgy	0.29844	Scup	0.00043			
Lobster	0.20001	Crab (Estuarine)	0.29086	Seafood	0.00040			
				Sturgeon				

Estimates are projected from a sample of 11,912 individuals to the U.S. population of 242,707,000 using 3-year combined survey weights.  
Source: U.S. EPA, 1996a.



Table 10C-4. Daily Average Per Capita Estimates Of Fish Consumption  
Uncooked Fish\*\* - Mean Consumption by Species Within Habitat  
U.S. Population

Habitat	Species	Estimated Mean Grams/person/day	Habitat	Species	Estimated Mean Grams/person/day	Habitat	Species	Estimated Mean Grams/person/day			
Estuarine	Shrimp	1.78619	Marine (Con't.)	Swordfish	0.17903	All Species (Con't.)	Flounder	0.28559			
	Perch	0.66494		Squid	0.14420		Lobster	0.27563			
	Flatfish	0.50832		Sardine	0.13750		Sea Bass	0.26661			
	Crab	0.40848		Pompano	0.12160		Scallop (Marine)	0.26199			
	Flounder	0.28559		Mackerel	0.09866		Oyster	0.18827			
	Oyster	0.18827		Sole	0.08339		Swordfish	0.17903			
	Mullet	0.08958		Whiting	0.06514		Squid	0.14420			
	Croaker	0.06539		Mussels	0.03718		Sardine	0.13750			
	Smelts	0.03470		Halibut	0.03030		Pompano	0.12160			
	Herring	0.03408		Shark	0.02385		Mackerel	0.09866			
	Clam	0.03339		Whitefish	0.00916		Mullet	0.08958			
	Anchovy	0.00304		Snapper	0.00551		Sole	0.08339			
	Scallop	0.00297		Octopus	0.00457		Croaker	0.06539			
	Scup	0.00050		Barracuda	0.00130		Whiting	0.06514			
	Sturgeon	0.00040		Abalone	0.00094		Carp	0.06012			
				Seafood	0.00043		Mussels	0.03718			
	Freshwater	Catfish		1.38715	Unknown		Fish	0.00248		Smelts	0.03470
		Trout		0.53777				Herring	0.03408		
Carp		0.06012	All Species	Tuna		5.67438		Clam (Estuarine)	0.03339		
Pike		0.02244		Shrimp		1.78619		Halibut	0.03030		
Salmon		0.01183		Cod		1.47609		Shark	0.02385		
Marine	Tuna	5.67438		Catfish	1.38715		Pike	0.02244			
	Cod	1.47609		Flatfish (Marine)	1.24268		Salmon (Freshwater)	0.01183			
	Flatfish	1.24268		Salmon (Marine)	0.99093		Whitefish	0.00916			
	Salmon	0.99093		Perch	0.66494		Snapper	0.00551			
	Haddock	0.62219		Haddock	0.62219		Octopus	0.00457			
	Pollock	0.52906		Trout	0.53777		Anchovy	0.00304			
	Crab	0.47567		Pollock	0.52906		Scallop (Estuarine)	0.00297			
	Porgy	0.42587		Flatfish (Estuarine)	0.50832		Fish	0.00248			
	Ocean Perch	0.39327		Crab (Marine)	0.47567		Barracuda	0.00130			
	Clam	0.37982		Porgy	0.42587		Abalone	0.00094			
	Lobster	0.27563		Crab (Estuarine)	0.40848		Scup	0.00050			
	Sea Bass	0.26661		Ocean Perch	0.39327		Seafood	0.00043			
	Scallop	0.26199		Clam (Marine)	0.37982		Sturgeon	0.00040			

Estimates are projected from a sample of 11,912 individuals to the U.S. population of 242,707,000 using 3-year combined survey weights.  
Source: U.S. EPA, 1996a.

# TABLE OF CONTENTS

	<u>Page No.</u>
11. INTAKE OF MEAT AND DAIRY PRODUCTS .....	1
11.1. INTAKE STUDIES .....	1
11.1.1. U.S. Department of Agriculture Nationwide Food Consumption Survey and Continuing Survey of Food Intake by Individuals . . . .	1
11.1.2. Key Meat and Dairy Products Intake Study Based on the CSFII .	2
11.1.3. Relevant Meat and Dairy Products Intake Studies .....	3
11.2. FAT CONTENT OF MEAT AND DAIRY PRODUCTS .....	6
11.3. CONVERSION BETWEEN AS CONSUMED AND DRY WEIGHT INTAKE RATES .....	7
11.4. RECOMMENDATIONS .....	7
<b>11.5. REFERENCES FOR CHAPTER 11 .....</b>	<b>7</b>

**11. INTAKE OF MEAT AND DAIRY PRODUCTS**

Consumption of meat, poultry, and dairy products is a potential pathway of exposure to toxic chemicals. These food sources can become contaminated if animals are exposed to contaminated media (i.e., soil, water, or feed crops).

The U.S. Department of Agriculture's (USDA) Nationwide Food Consumption Survey (NFCS) and Continuing Survey of Food Intakes by Individuals (CSFII) are the primary sources of information on intake rates of meat and dairy products in the United States. Data from the NFCS have been used in various studies to generate consumer-only and per capita intake rates for both individual meat and dairy products and total meat and dairy products. CSFII 1989-91 survey data have been analyzed by EPA to generate per capita intake rates for various food items and food groups. As described in Volume II, Chapter 9 - Intake of Fruits and Vegetables, consumer-only intake is defined as the quantity of meat and dairy products consumed by individuals who ate these food items during the survey period. Per capita intake rates are generated by averaging consumer-only intakes over the entire population of users and non-users. In general, per capita intake rates are appropriate for use in exposure assessments for which average dose estimates for the general population are of interest because they represent both individuals who ate the foods during the survey period and individuals who may eat the food items at some time, but did not consume them during the survey period.

Intake rates may be presented on either an as consumed or dry weight basis. As consumed intake rates (g/day) are based on the weight of the food in the form that it is consumed. In contrast, dry weight intake rates are based on the weight of the food consumed after the moisture content has been removed. In calculating exposures based on ingestion, the unit of weight used to measure intake should be consistent with those used in measuring the contaminant concentration in the produce. Fat content data are also presented for various meat and dairy products. These data are needed for converting between residue levels on a whole-weight or as consumed basis and lipid basis. Intake data from the individual component of the NFCS and CSFII are based on "as eaten" (i.e., cooked or prepared) forms of the food items/groups. Thus, corrections to account for changes in portion sizes from cooking losses are not required.

The purpose of this section is to provide: (1) intake data for individual meat and dairy products, total meat, and total dairy; (2) guidance for converting between as

consumed and dry weight intake rates; and (3) data on the fat content in meat and dairy products. Recommendations are based on average and upper-percentile intake among the general population of the U.S. Available data have been classified as being either a key or a relevant study based on the considerations discussed in Volume I, Section 1.3.1 of the Introduction. Recommendations are based on data from the 1989-91 CSFII survey, which was considered the only key intake study for meats and dairy products. Other relevant studies are also presented to provide the reader with added perspective on this topic. It should be noted that most of the studies presented in this section are based on data from USDA's NFCS and CSFII. The USDA NFCS and CSFII are described below.

**11.1. INTAKE STUDIES****11.1.1. U.S. Department of Agriculture Nationwide Food Consumption Survey and Continuing Survey of Food Intake by Individuals**

The NFCS and CSFII are the basis of much of the data on meat and dairy intake presented in this section. Data from the 1977-78 NFCS are presented because the data have been published by USDA in various reports and reanalyzed by various EPA offices according to the food items/groups commonly used to assess exposure. Published one-day data from the 1987-88 NFCS and 1994 and 1995 CSFII are also presented. Recently, EPA conducted an analysis of USDA's 1989-91 CSFII. These data were the most recent food survey data that were available to the public at the time that EPA analyzed the data for this Handbook. The results of EPA's analyses are presented here. Detailed descriptions of the NFCS and CSFII data are presented in Volume II, Chapter 9 - Intake of Fruits and Vegetables.

Individual average daily intake rates calculated from NFCS and CSFII data are based on averages of reported individual intakes over one day or three consecutive days. Such short term data are suitable for estimating average daily intake rates representative of both short-term and long-term consumption. However, the distribution of average daily intake rates generated using short term data (e.g., 3 day) do not necessarily reflect the long-term distribution of average daily intake rates. The distributions generated from short term and long term data will differ to the extent that each individual's intake varies from day to day; the distributions will be similar to the extent that individuals' intakes are constant from day to day.

Day-to-day variation in intake among individuals will be great for food item/groups that are highly seasonal



and for items/groups that are eaten year around but that are not typically eaten every day. For these foods, the intake distribution generated from short term data will not be a good reflection of the long term distribution. On the other hand, for broad categories of foods (e.g., total meats) which are eaten on a daily basis throughout the year with minimal seasonality, the short term distribution may be a reasonable approximation of the true long term distribution, although it will show somewhat more variability. In this and the following section then, distributions are shown only for the following broad categories of foods: total meats and total dairy products. Because of the increased variability of the short-term distribution, the short-term upper percentiles shown will overestimate somewhat the corresponding percentiles of the long-term distribution.

#### **11.1.2. Key Meat and Dairy Products Intake Study Based on the CSFII**

*U.S. EPA Analysis of 1989-91 USDA CSFII Data* - EPA conducted an analysis of USDA's 1989-91 CSFII data set. The general methodology used in analyzing the data is presented in Volume II, Chapter 9 - Intake of Fruits and Vegetables of this Handbook. Intake rates were generated for the following meat and dairy products: total meats, total dairy, beef, pork, poultry, game, and eggs. Appendix 9B presents the food categories and codes used in generating intake rates for these food groups. These data have been corrected to account for mixtures as described in Volume II, Chapter 9 - Intake of Fruits and Vegetables and Appendix 9A. However, it should be noted that although total meats account for items such as luncheon meats, sausages, and organ meats, these items are not included in the individual meat groups (i.e., beef, poultry, etc.). Per capita intake rates for total meat and total dairy are presented in Tables 11-1 and 11-2 at the end of this Chapter. Tables 11-3 to 11-7 present per capita intake data for individual meats and eggs. The results are presented in units of g/kg-day. Thus, use of these data in calculating potential dose does not require the body weight factor to be included in the denominator of the average daily dose (ADD) equation. It should be noted that converting these intake rates into units of g/day by multiplying by a single average body weight is inappropriate, because individual intake rates were indexed to the reported body weights of the survey respondents. However, if there is a need to compare the intake data presented here to intake data in units of g/day, a body weight less than 70 kg (i.e., approximately 60 kg; calculated based on the number of respondents in each age category and the average body weights for these age groups, as

presented in Volume I, Chapter 7, Body Weight) should be used because the total survey population included children as well as adults.

The advantages of using the 1989-91 CSFII data set are that the data are expected to be representative of the U.S. population and that it includes data on a wide variety of food types. The data set was the most recent of a series of publicly available USDA data sets (i.e., NFCS 1977-78; NFCS 1987-88; CSFII 1989-91) at the time the analysis was conducted for this Handbook, and should reflect recent eating patterns in the United States. The data set includes three years of intake data combined. However, the 1989-91 CSFII data are based on a three day survey period. Short-term dietary data may not accurately reflect long-term eating patterns. This is particularly true for the tails of the distribution of food intake. In addition, the adjustment for including mixtures adds uncertainty to the intake rate distributions. The calculation for including mixtures assumes that intake of any mixture includes all of the foods identified and the proportions specified in Appendix Table 9A-1. This assumption yields valid estimates of per capita consumption, but results in overestimates of the proportion of the population consuming individual meats; thus, the quantities reported in Tables 11-3 to 11-7 should be interpreted as upper bounds on the proportion consuming beef, pork, poultry, game, and eggs.

The data presented in this handbook for the USDA 1989-91 CSFII is not the most up-to-date information on food intake. USDA has recently made available the data from its 1994 and 1995 CSFII. Over 5,500 people nationwide participated in both of these surveys, providing recalled food intake information for 2 separate days. Although the two-day data analysis has not been conducted, USDA published the results for the respondents' intakes on the first day surveyed (USDA, 1996a,b). USDA 1996 survey data will be made available later in 1997. As soon as 1996 data are available, EPA will take steps to get the 3-year data (1994, 1995, and 1996) analyzed and the food ingestion factors updated. Meanwhile, Table 11-8 presents a comparison of the mean daily intakes per individual in a day for the major meat and dairy groups from USDA survey data from years 1977-78, 1987-88, 1989-91, 1994, and 1995. This table shows that food consumption patterns have changed for beef and meat mixtures when comparing 1977 and 1995 data. In particular, consumption of beef decreased by 50 percent when comparing data from 1977 and 1995, while consumption of meat mixtures increased by 44 percent. However, consumption of the food items presented in Table 11-8 has remained fairly constant when



comparing values from 1989-91 with the most recent data from 1994 and 1995. Meat mixtures show the largest change with an increase of 16 percent from 1989 to 1995. This indicates that the 1989-91 CSFII data are probably adequate for assessing ingestion exposure for current populations; however, these data should be used with caution.

It is interesting to note that there was not much variation in beef and poultry consumption from 1989-91 to 1995. This seems to contradict the other USDA reports that show that in recent years the U.S. population has been substituting beef for other sources of protein such as poultry and fish. One of those reports is the report titled Meat and Poultry Inspection; 1994 Report of the Secretary of Agriculture to the U.S. Congress (USDA, 1994). This USDA report shows a 39% increase in the number of poultry inspected at federally inspected plants in 1994 compared to 1984. In contrast, the number of meat animals inspected at federally inspected plants increased only by 2% from 1984 to 1994. This trend in food consumption patterns was also reported in the USDA report titled Food Consumption, Prices, and Expenditures, 1970-92 (USDA, 1993). This report shows that in 1992, consumption among Americans averaged 18 pounds less red meat, 26 pounds more poultry, and 3 pounds more fish and shellfish than in 1970. This apparent contradiction may be explained by assuming that most of the increase in poultry consumption has occurred in the meat mixtures and grain mixtures categories. There has been a considerable shift from consuming individual food items to food in mixtures (such as pizza, tacos, burritos, frozen entrees, and salads from grocery stores). This may explain why, in Table 11-8, domestic consumption has remained fairly constant in the past few years.

### **11.1.3. Relevant Meat and Dairy Products Intake Studies**

*The U.S. EPA's Dietary Risk Evaluation System (DRES) - U.S. EPA, Office of Pesticide Programs (OPP) - EPA OPP's DRES contains per capita intake rate data for various items of meat, poultry, and dairy products for 22 subgroups (age, regional, and seasonal) of the population. As described in Volume II, Chapter 9 - Intake of Fruits and Vegetables, intake data in DRES were generated by determining the composition of 1977/78 NFCS food items and disaggregating complex food dishes into their component raw agricultural commodities (RACs) (White et al., 1983). The DRES per capita, as consumed intake rates for all age/sex/demographic groups combined are presented*

in Table 11-9. These data are based on both consumers and non-consumers of these food items. Data for specific subgroups of the population are not presented in this section, but are available through OPP via direct request. The data in Table 11-9 may be useful for estimating the risks of exposure associated with the consumption of the various meat, poultry, and dairy products presented. It should be noted that these data are indexed to the reported body weights of the survey respondents and are expressed in units of grams of food consumed per kg body weight per day. Consequently, use of these data in calculating potential dose does not require the body weight factor in the denominator of the average daily dose (ADD) equation. It should also be noted that conversion of these intake rates into units of g/day by multiplying by a single average body weight is not appropriate because the DRES data base did not rely on a single body weight for all individuals. Instead, DRES used the body weights reported by each individual surveyed to estimate consumption in units of g/kg-day.

The advantages of using these data are that complex food dishes have been disaggregated to provide intake rates for a variety of meat, poultry, and dairy products. These data are also based on the individual body weights of the respondents. Therefore, the use of these data in calculating exposure to toxic chemicals may provide more representative estimates of potential dose per unit body weight. However, because the data are based on NFCS short-term dietary recall, the same limitations discussed previously for other NFCS data sets also apply here. In addition, consumption patterns may have changed since the data were collected in 1977-78. OPP is in the process of translating consumption information from the USDA CSFII 1989-91 survey to be used in DRES.

*Food and Nutrient Intakes of Individuals in One Day in the U.S., USDA (1980, 1992, 1996a, 1996b) - USDA calculated mean per capita intake rates for meat and dairy products using NFCS data from 1977-78 and 1987-88 (USDA, 1980; 1992) and CSFII data from 1994 and 1995 (USDA, 1996a; 1996b). The mean per capita intake rates for meat and dairy products are presented in Tables 11-10 and 11-11 for meats and Tables 11-12 and 11-13 for dairy based on intake data for one day from the 1977-78 and 1987-88 USDA NFCSs. Tables 11-14 and 11-15 present similar data from the 1994 and 1995 CSFII for meats and dairy products, respectively.*

The advantages of using these data are that they provide mean intake estimates for all meat, poultry, and dairy products. The consumption estimates are based on



short-term (i.e., 1-day) dietary data which may not reflect long-term consumption.

*U.S. EPA - Office of Radiation Programs* - The U.S. EPA Office of Radiation Programs (ORP) has also used the USDA 1977-78 NFCS to estimate daily food intake. ORP uses food consumption data to assess human intake of radionuclides in foods (U.S. EPA, 1984a; 1984b). The 1977-78 NFCS data have been reorganized by ORP, and food items have been classified according to the characteristics of radionuclide transport. The mean per capita dietary intake of food sub classes (milk, other dairy products, eggs, beef, pork, poultry, and other meat) grouped by age for the U.S. population is presented in Table 11-16. The mean daily intake rates of meat, poultry, and dairy products for the U.S. population grouped by regions are presented in Table 11-17. Because this study was based on the USDA NFCS, the limitations and advantages associated with the USDA NFCS data also apply to these data. Also, consumption patterns may have changed since the data were collected in 1977-78.

*U.S. EPA - Office of Science and Technology* - The U.S. EPA Office of Science and Technology (OST) within the Office of Water (formerly the Office of Water Regulations and Standards) used data from the FDA revision of the Total Diet Study Food Lists and Diets (Pennington, 1983) to calculate food intake rates. OST uses these consumption data in its risk assessment model for land application of municipal sludge. The FDA data used are based on the combined results of the USDA 1977-78 NFCS and the second National Health and Nutrition Examination Survey (NHANES II), 1976-80 (U.S. EPA, 1989). Because food items are listed as prepared complex foods in the FDA Total Diet Study, each item was broken down into its component parts so that the amount of raw commodities consumed could be determined. Table 11-18 presents intake rates for meat, poultry, and dairy products for various age groups. Estimated lifetime ingestion rates derived by U.S. EPA (1989) are also presented in Table 11-18. Note that these are per capita intake rates tabulated as grams dry weight/day. Therefore, these rates differ from those in the previous tables because Pao et al. (1982) and U.S. EPA (1984a, 1984b) report intake rates on an as consumed basis.

The EPA-OST analysis provides intake rates for additional food categories and estimates of lifetime average daily intake on a per capita basis. In contrast to the other analyses of USDA NFCS data, this study reports the data in terms of dry weight intake rates. Thus, conversion is not required when contaminants are provided on a dry weight

basis. These data, however, may not reflect current consumption patterns because they are based on 1977-78 data.

*USDA (1993) - Food Consumption, Prices, and Expenditures, 1970-92* -The USDA's Economic Research Service (ERS) calculates the amount of food available for human consumption in the United States annually. Supply and utilization balance sheets are generated. These are based on the flow of food items from production to end uses. Total available supply is estimated as the sum of production (i.e., some products are measured at the farm level or during processing), starting inventories, and imports (USDA, 1993). The availability of food for human use commonly termed as "food disappearance" is determined by subtracting exported foods, products used in industries, farm inputs (seed and feed) and end-of-the year inventories from the total available supply (USDA, 1993). USDA (1993) calculates the per capita food consumption by dividing the total food disappearance by the total U.S. population.

USDA (1993) estimated per capita consumption data for meat, poultry, and dairy products from 1970-1992 (1992 data are preliminary). In this section, the 1991 values, which are the most recent final data, are presented. The meat consumption data were reported as carcass weight, retail weight equivalent, and boneless weight equivalent. The poultry consumption data were reported as ready-to-cook (RTC) weight, retail weight, and boneless weight (USDA, 1993). USDA (1993) defined beef carcass weight as the chilled hanging carcass, which includes the kidney and attached internal fat (kidney, pelvic, and heart fat), excludes the skin, head, feet, and unattached internal organs. The pork carcass weight includes the skin and feet, but excludes the kidney and attached internal fat. Retail weight equivalents assume all food was sold through retail foodstores; therefore, conversion factors (Table 11-19) were used to correct carcass or RTC to retail weight to account for trimming, shrinkage, or loss of meat and chicken at these retail outlets (USDA, 1993). Boneless equivalent values for meat (pork, veal, beef) and poultry excludes all bones, but includes separable fat sold on retail cuts of red meat. Pet food was considered as an apparent source of food disappearance for poultry in boneless weight estimates, while pet food was excluded for beef, veal, and pork (USDA, 1993). Table 11-19 presents per capita consumption in 1991 for red meat (carcass weight, retail equivalent, and boneless trimmed equivalent) and poultry (RTC, retail equivalent for chicken only, and boneless trimmed equivalent). Per capita consumption estimates



based on boneless weights appear to be the most appropriate data for use in exposure assessments, because boneless meats are more representative of what people would actually consume. Table 11-20 presents per capita consumption in 1991 for dairy products including eggs, milk, cheese, cream, and sour cream.

One of the limitations of this study is that disappearance data do not account for losses from the food supply from waste, spoilage, or foods fed to pets. Thus, intake rates based on these data will overestimate daily consumption because they are based on the total quantity of marketable commodity utilized. Therefore, these data may be useful for estimating bounding exposure estimates. It should also be noted that per capita estimates based on food disappearance are not a direct measure of actual consumption or quantity ingested, instead the data are used as indicators of changes in usage over time (USDA, 1993). An advantage of this study is that it provides per capita consumption rates for meat, poultry, and dairy products which are representative of long-term intake because disappearance data are generated annually. Daily per capita intake rates are generated by dividing annual consumption by 365 days/year.

*National Live Stock and Meat Board (1993) - Eating in America Today: A Dietary Pattern and Intake Report* - The National Live Stock and Meat Board (NLMB) (1993) assessed the nutritional value of the current American diet based on two factors: (1) the composition of the foods consumed, and (2) the amount of food consumed. Data used in this study were provided by MRCA Information Services, Inc. through MRCA's Nutritional Marketing Information Division. The survey conducted by MRCA consisted of a 2,000 household panels of over 4,700 individuals. The survey sample was selected to be representative of the U.S. population. Information obtained from the survey by MRCA's Menu Census included food and beverage consumption over a period of 14 consecutive days. The head of the household recorded daily food and beverage consumption in-home and away-from-home in diaries for each household member. The survey period was from July 1, 1990 through June 30, 1991. This ensured that all days carried equal weights and provided a seasonally balanced data set. In addition, nutrient intake data calculated by the MRCA's Nutrient Intake Database (NID) (based on the 1987-88 USDA Food Intake Study) and information on food attitudes were also collected. It should be noted, however, that the 14 daily diaries provided only the incidence of eating each food product by an individual, but not the quantity eaten by each person. The intake rate

for each individual was estimated by multiplying the eating frequency of a particular food item by the average amount eaten per eating occasion. The data on the average amount eaten per eating occasion were obtained from the USDA NFCS survey.

Table 11-21 presents the adult daily mean intake of meat and poultry grouped by region and gender. The adult population was defined as consumers ages 19 and above (NLMB, 1993). Beef consumption was high in all regions compared to other meats and poultry (Table 11-21). The average daily consumption of meat in the U.S. was 114.2 g/day which included beef (57 percent), veal (0.5 percent), lamb (0.5 percent), game/variety meats (8 percent), processed meats (18 percent), and pork (16 percent) (NLMB, 1993). Table 11-22 shows the amount of meat consumed by the adult population grouped as non-meat eaters (1 percent), light meat eaters (30 percent), medium meat eaters (33 percent), and heavy meat eaters (36 percent).

The advantage of this study is that the survey period is longer (i.e., 14 days) than any other food consumption survey. The survey is also based on a nationally representative sample. The survey also accounts for foods eaten as mixtures. However, only mean values are provided. Therefore, distribution of long-term consumption patterns cannot be derived. In addition, the survey collects data on incidence of eating each food item and not actual consumption rates. This may introduce some bias in the results. The direction of this bias is unknown.

*AIHC (1994) - Exposure Factors Sourcebook* - The AIHC Sourcebook (AIHC, 1994) uses the data presented in the 1989 version of the Exposure Factors Handbook which reported data from the USDA 1977-78 NFCS. In this Handbook, new analyses of more recent data from the USDA 1989-91 CSFII are presented. Numbers, however, cannot be directly compared with previous values since the results from the new analysis are presented on a body weight basis. The Sourcebook was selected as a relevant study because it was not the primary source for the data used to make recommendations in this document. However, it is an alternative information source.

*Pao et al. (1982) - Foods Commonly Eaten by Individuals* - Using data gathered in the 1977-78 USDA NFCS, Pao et al. (1982) calculated percentiles for the quantities of meat, poultry, and dairy products consumed per eating occasion by members of the U.S. population. The data were collected during NFCS home interviews of 37,874 respondents, who were asked to recall food intake for the day preceding the interview, and record food intake





the day of the interview and the day after the interview. Quantities consumed per eating occasion, are presented in Table 11-23.

The advantages of using these data are that they were derived from the USDA NFCS and are representative of the U.S. population. This data set provides distributions of serving sizes for a number of commonly eaten meat, poultry, and dairy products, but the list of foods is limited and does not account for meat, poultry, and dairy products included in complex food dishes. Also, these data are based on short-term dietary recall and may not accurately reflect long-term consumption patterns. Although these data are based on the 1977-78 NFCS, serving size data have been collected but not published for the more recent USDA surveys.

### 11.2. FAT CONTENT OF MEAT AND DAIRY PRODUCTS

In some cases, the residue levels of contaminants in meat and dairy products are reported as the concentration of contaminant per gram of fat. This may be particularly true for lipophilic compounds. When using these residue levels, the assessor should ensure consistency in the exposure assessment calculations by using consumption rates that are based on the amount of fat consumed for the meat or dairy product of interest. Alternately, residue levels for the "as consumed" portions of these products may be estimated by multiplying the levels based on fat by the fraction of fat per product as follows:

$$\frac{\text{residue level}}{\text{g-product}} = \frac{\text{residue level}}{\text{g-fat}} \times \frac{\text{g-fat}}{\text{g-product}} \quad (\text{Eqn. 11-1})$$

The resulting residue levels may then be used in conjunction with "as consumed" consumption rates. The percentages of lipid fat in meat and dairy products have been reported in various publications. USDA's Agricultural Handbook Number 8 (USDA, 1979-1984) provides composition data for agricultural products. It includes a listing of the total saturated, monounsaturated, and polyunsaturated fats for various meat and dairy items. Table 11-24 presents the total fat content for selected meat and dairy products taken from Handbook Number 8. The total percent fat content is based on the sum of saturated, monounsaturated, and polyunsaturated fats.

The National Livestock and Meat Board (NLMB) (1993) used data from Agricultural Handbook Number 8

and consumption data to estimate the fat contribution to the U.S. diet. Total fat content in grams, based on a 3-ounce (85.05 g) cooked serving size, was reported for several categories (retail composites) of meats. These data are presented in Table 11-25 along with the corresponding percent fat content values for each product. NLMB (1993) also reported that 0.17 grams of fat are consumed per gram of meat (i.e., beef, pork, lamb, veal, game, processed meats, and variety meats) (17 percent) and 0.08 grams of fat are consumed per gram of poultry (8 percent).

The average total fat content of the U.S. diet was reported to be 68.3 g/day. The meat group (meat, poultry, fish, dry beans, eggs, and nuts) was reported to contribute the most to the average total fat in the diet (41 percent) (NLMB, 1993). Meats (i.e., beef, pork, lamb, veal, game, processed meats, and variety meats) reportedly contribute less than 30 percent to the total fat of the average U.S. diet. The milk group contributes approximately 12 percent to the average total fat in the U.S. diet (NLMB, 1993). Fat intake rates and the contributions of the major food groups to fat intake for heavy, medium, and light meat eaters, and non meat eaters are presented in Table 11-26 (NLMB, 1993). NLMB (1993) also reported the average meat fat intake to be 19.4 g/day, with beef contributing about 50 percent of the fat to the diet from all meats. Processed meats contributed 31 percent; pork contributed 14 percent; game and variety meats contributed 4 percent; and lamb and veal contributed 1 percent to the average meat fat intake.

The Center for Disease Control (CDC) (1994) used data from NHANES III to calculate daily total food energy intake (TFEI), total dietary fat intake, and saturated fat intake for the U.S. population during 1988 to 1991. The sample population comprised 20,277 individuals ages 2 months and above, of which 14,001 respondents (73 percent response rate) provided dietary information based on a 24-hour recall. TFEI was defined as "all nutrients (i.e., protein, fat, carbohydrate, and alcohol) derived from consumption of foods and beverages (excluding plain drinking water) measured in kilocalories (kcal)." Total dietary fat intake was defined as "all fat (i.e., saturated and unsaturated) derived from consumption of foods and beverages measured in grams."

CDC (1994) estimated and provided data on the mean daily TFEI and the mean percentages of TFEI from total dietary fat grouped by age and gender. The overall mean daily TFEI was 2,095 kcal for the total population and 34 percent (or 82 g) of their TFEI was from total dietary fat (CDC, 1994). Based on this information, the mean daily fat intake was calculated for the various age groups and



genders (see Appendix 11A for detailed calculation). Table 11-27 presents the grams of fat per day obtained from the daily consumption of foods and beverages grouped by age and gender for the U.S. population, based on this calculation.

### 11.3. CONVERSION BETWEEN AS CONSUMED AND DRY WEIGHT INTAKE RATES

As noted previously, intake rates may be reported in terms of units as consumed or units of dry weight. It is essential that exposure assessors be aware of this difference so that they may ensure consistency between the units used for intake rates and those used for concentration data (i.e., if the unit of food consumption is grams dry weight/day, then the unit for the amount of pollutant in the food should be grams dry weight). If necessary, as consumed intake rates may be converted to dry weight intake rates using the moisture content percentages of meat, poultry and dairy products presented in Table 11-28 and the following equation:

$$IR_{dw} = IR_{ac} * [(100-W)/100] \quad (\text{Eqn. 11-2})$$

Dry weight" intake rates may be converted to "as consumed" rates by using:

$$IR_{ac} = IR_{dw}/[(100-W)/100] \quad (\text{Eqn. 11-3})$$

where:

$IR_{dw}$  = dry weight intake rate;  
 $IR_{ac}$  = as consumed intake rate; and  
W = percent water content.

### 11.4. RECOMMENDATIONS

The 1989-91 CSFII data described in this section were used in selecting recommended meat, poultry, and dairy product intake rates for the general population and various subgroups of the United States population. The general design of both key and relevant studies are summarized in Table 11-29. The recommended values for intake of meat and dairy products are summarized in Table 11-30 and the confidence ratings for the recommended values for meat and dairy intake rates are presented in Table 11-31. Per capita intake rates for specific meat items, on a g/kg-day basis, may be obtained from Tables 11-3 to 11-7. Percentiles of the intake rate distribution in the general population for total meat and total dairy are presented in

Tables 11-1 and 11-2. From these tables, the mean and 95th percentile intake rates for meats are 2.1 g/kg-day and 5.1 g/kg-day, respectively. The mean and 95th percentile intake rates for dairy products are 8.0 g/kg-day and 29.7 g/kg-day. It is important to note that the data presented in Tables 11-1 through 11-7 are based on data collected over a 3-day period and may not necessarily reflect the long-term distribution of average daily intake rates. However, for these broad categories of food (i.e., total meats and total dairy products), because they may be eaten on a daily basis throughout the year with minimal seasonality, the short-term distribution may be a reasonable approximation of the long-term distribution, although it will display somewhat increased variability. This implies that the upper percentiles shown here will tend to overestimate the corresponding percentiles of the true long-term distribution. Intake rates for the homeproduced form of these food items/groups are presented in Volume II, Chapter 13. It should be noted that because these recommendations are based on 1989-91 CSFII data, they may not reflect recent the most changes in consumption patterns. However, as indicated in Table 11-8, intake has remained fairly constant between 1989-91 and 1995. Thus, the 1989-91 CSFII data are believed to be appropriate for assessing ingestion exposure for current populations.

### 11.5. REFERENCES FOR CHAPTER 11

- American Industrial Health Council (AIHC). (1994) Exposure factors sourcebook. Washington, DC., AIHC.
- CDC. (1994) Dietary fat and total food-energy intake. Third National Health and Nutrition Examination Survey, Phase 1, 1988-91. Morbidity and Mortality Weekly Report, February 25, 1994: 43(7)118-125.
- Finley, B.L.; Paustenbach, B.L. (1992) Opportunities for improving exposure assessments using population distribution estimates. Presented for the Committee on Risk Assessment Methodology, February 10-11, Washington, DC.
- National Livestock and Meat Board (NLMB). (1993) Eating in America today: A dietary pattern and intake report. National Livestock and Meat Board. Chicago, IL.
- Pao, E.M.; Fleming, K.H.; Guenther, P.M.; Mickle, S.J. (1982) Foods commonly eaten by individuals: amount per day and per eating occasion. U.S. Department of Agriculture. Home Economics Report No. 44.



- Pennington, J.A.T. (1983) Revision of the total diet study food list and diets. *J. Am. Diet. Assoc.* 82:166-173.
- USDA. (1979-1984) *Agricultural Handbook No. 8.* United States Department of Agriculture.
- USDA. (1980) Food and nutrient intakes of individuals in one day in the United States, Spring 1977. U.S. Department of Agriculture. *Nationwide Food Consumption Survey 1977-1978. Preliminary Report No. 2.*
- USDA. (1992) Food and nutrient intakes by individuals in the United States, 1 day, 1987-88. U.S. Department of Agriculture, Human Nutrition Information Service. *Nationwide Food Consumption Survey 1987-88, NFCS Rpt. No. 87-I-1.*
- USDA. (1993) Food consumption, prices, and expenditures (1970-1992) U.S. Department of Agriculture, Economic Research Service. *Statistical Bulletin, No. 867.*
- USDA. (1994) Meat and poultry inspection; 1994 report of the Secretary of Agriculture to the U.S. Congress. Washington, DC: U.S. Department of Agriculture.
- USDA. (1996a) Data tables: results from USDA's 1994 Continuing Survey of Food Intakes by Individuals and 1994 Diet and Health Knowledge Survey. U.S. Department of Agriculture, Agricultural Research Service, Riverdale, MD.
- USDA. (1996b) Data tables: results from USDA's 1995 Continuing Survey of Food Intakes by Individuals and 1995 Diet and Health Knowledge Survey. U.S. Department of Agriculture, Agricultural Research Service, Riverdale, MD.
- U.S. EPA. (1984a) An estimation of the daily average food intake by age and sex for use in assessing the radionuclide intake of individuals in the general population. EPA-520/1-84-021.
- U.S. EPA. (1984b) An estimation of the daily food intake based on data from the 1977-1978 USDA Nationwide Food Consumption Survey. Washington, DC: Office of Radiation Programs. EPA-520/1-84-015.
- U.S. EPA. (1989) Development of risk assessment methodologies for land application and distribution and marketing of municipal sludge. Washington, DC: Office of Science and Technology. EPA 600/-89/001.
- White, S.B.; Peterson, B.; Clayton, C.A.; Duncan, D.P. (1983) Interim Report Number 1: The construction of a raw agricultural commodity consumption data base. Prepared by Research Triangle Institute for EPA Office of Pesticide Programs.



Table 11-1. Per Capita Intake of Total Meats (g/kg-day as consumed)

Population Group	Percent Consuming												
	Mean	SE	P1	P5	P10	P25	P50	P75	P90	P95	P99	P100	
<b>Total</b>	96.4%	2.146	0.014	0	0.33	0.63	1.13	1.84	2.78	4.06	5.06	7.67	25.67
<b>Age (years)</b>													
< 01	66.7%	2.867	0.187	0	0	0	0	2.34	4.72	6.52	8.56	11.52	25.67
01-02	95.6%	4.384	0.116	0	1.07	1.58	2.70	4.13	5.38	7.69	8.41	11.88	21.61
03-05	97.5%	3.873	0.092	0	1.12	1.38	2.21	3.50	5.04	6.64	8.23	11.25	15.00
06-11	97.6%	3.011	0.052	0	0.66	1.02	1.80	2.78	3.98	5.12	6.08	8.38	11.68
12-19	97.7%	2.078	0.034	0	0.42	0.67	1.19	1.99	2.79	3.49	4.40	5.95	8.28
20-39	97.9%	1.923	0.019	0	0.39	0.64	1.09	1.73	2.54	3.49	4.14	5.46	8.37
40-69	97.3%	1.700	0.017	0	0.36	0.59	1.03	1.58	2.20	2.95	3.47	4.73	7.64
70 +	97.1%	1.531	0.028	0	0.32	0.49	0.89	1.42	2.03	2.73	3.20	4.28	6.63
<b>Season</b>													
Fall	97.1%	2.182	0.029	0	0.37	0.66	1.15	1.85	2.80	4.11	5.16	8.06	25.67
Spring	95.8%	2.053	0.027	0	0.26	0.61	1.09	1.75	2.63	3.93	4.91	7.31	15.00
Summer	96.3%	2.178	0.031	0	0.35	0.63	1.11	1.86	2.84	4.10	5.18	7.86	18.19
Winter	96.4%	2.173	0.029	0	0.30	0.63	1.18	1.88	2.87	4.06	5.05	7.35	14.61
<b>Urbanization</b>													
Central City	96.7%	2.163	0.028	0	0.25	0.59	1.09	1.79	2.82	4.14	5.22	7.97	25.67
Nonmetropolitan	95.7%	2.168	0.028	0	0.30	0.63	1.15	1.90	2.79	4.04	5.12	7.69	14.61
Suburban	96.6%	2.126	0.021	0	0.39	0.64	1.13	1.84	2.74	4.03	4.94	7.31	15.00
<b>Race</b>													
Asian	89.3%	2.233	0.131	0	0	0.60	1.10	1.86	3.23	4.49	4.66	6.86	8.13
Black	95.5%	2.434	0.053	0	0.33	0.62	1.15	1.94	3.02	5.03	6.14	9.87	25.67
Native American	86.5%	2.269	0.131	0	0	0.41	1.32	1.87	3.38	4.64	5.09	7.32	8.57
Other/NA	95.1%	2.628	0.109	0	0	0.65	1.40	2.29	3.34	4.90	6.03	11.25	11.25
White	96.9%	2.083	0.015	0	0.34	0.63	1.12	1.81	2.72	3.87	4.87	7.18	18.19
<b>Region</b>													
Midwest	96.5%	2.204	0.029	0	0.44	0.69	1.21	1.85	2.82	4.08	5.05	7.86	21.61
Northeast	96.5%	2.148	0.033	0	0.35	0.67	1.16	1.89	2.75	3.98	4.99	8.27	15.00
South	96.7%	2.249	0.025	0	0.37	0.68	1.18	1.90	2.88	4.35	5.34	7.73	13.42
West	95.8%	1.903	0.030	0	0.08	0.47	0.92	1.60	2.54	3.69	4.57	6.64	25.67

NOTE: SE = Standard error  
P = Percentile of the distribution  
Source: Based on EPA's analyses of the 1989-91 CSFII



Table 11-2. Per Capita Intake of Total Dairy Products (g/kg-day as consumed)

Population Group	Percent Consuming	Mean	SE	P1	P5	P10	P25	P50	P75	P90	P95	P99	P100
<b>Total</b>	97.1%	8.015	0.147	0	0.15	0.40	1.36	3.61	8.18	18.55	29.72	72.16	390.53
<b>Age (years)</b>													
< 01	89.6%	62.735	2.800	0	0	0.61	24.68	45.78	91.12	136.69	170.86	210.72	390.53
01-02	95.6%	26.262	0.743	0	2.69	8.19	15.22	23.48	36.13	45.72	55.07	69.42	108.95
03-05	97.5%	21.149	0.517	0	3.27	6.75	11.89	19.52	28.31	39.54	44.16	57.58	62.88
06-11	97.4%	13.334	0.264	0	1.81	3.54	6.72	11.88	18.58	25.38	28.76	39.60	62.55
12-19	97.9%	6.293	0.147	0	0.27	0.61	2.31	5.29	9.20	12.75	15.12	23.58	53.47
20-39	97.9%	3.618	0.062	0	0.12	0.30	0.95	2.64	5.04	8.15	10.64	17.23	43.31
40-69	96.9%	3.098	0.053	0	0.10	0.26	0.94	2.23	4.36	6.99	9.05	12.99	34.42
70 +	97.6%	3.715	0.104	0	0.16	0.47	1.46	3.03	4.93	8.03	9.63	16.49	26.33
<b>Season</b>													
Fall	97.7%	8.262	0.286	0	0.17	0.38	1.32	3.53	8.31	20.16	32.71	75.83	351.48
Spring	96.8%	8.273	0.335	0	0.13	0.39	1.37	3.50	7.88	18.02	27.02	116.00	390.53
Summer	96.8%	7.561	0.257	0	0.14	0.37	1.37	3.51	7.93	18.01	30.86	64.95	347.93
Winter	97.1%	7.964	0.293	0	0.16	0.43	1.39	3.90	8.77	17.60	27.34	63.27	307.54
<b>Urbanization</b>													
Central City	97.2%	8.528	0.309	0	0.17	0.41	1.44	3.78	8.05	18.25	29.51	106.93	318.93
Nonmetropolitan	96.6%	7.224	0.261	0	0.10	0.28	1.08	3.34	7.82	17.28	24.70	59.17	390.53
Suburban	97.4%	8.058	0.209	0	0.17	0.43	1.42	3.61	8.45	19.50	32.04	69.42	351.48
<b>Race</b>													
Asian	94.0%	8.730	1.264	0	0	0.14	0.63	3.86	7.23	21.62	36.16	72.01	124.26
Black	94.8%	7.816	0.498	0	0.03	0.11	0.64	2.49	7.29	17.28	27.78	116.00	347.93
Native American	88.9%	6.987	1.057	0	0.02	0.14	0.81	2.83	8.06	20.20	24.17	66.71	139.37
Other/NA	97.1%	10.727	1.002	0	0.12	0.33	1.03	4.15	11.28	34.64	40.33	121.50	166.48
White	97.7%	7.943	0.156	0	0.22	0.49	1.50	3.76	8.24	18.16	28.76	66.11	390.53
<b>Region</b>													
Midwest	97.3%	9.291	0.341	0	0.20	0.50	1.66	4.20	9.61	21.33	34.35	90.88	390.53
Northeast	97.2%	7.890	0.330	0	0.18	0.42	1.42	3.41	7.54	18.07	32.04	78.15	307.54
South	97.3%	6.926	0.225	0	0.11	0.27	1.01	3.10	7.49	15.86	25.76	54.94	347.93
West	96.7%	8.454	0.313	0	0.17	0.49	1.60	3.93	8.67	19.88	29.89	84.46	174.65
NOTE: SE = Standard error P = Percentile of the distribution Source: Based on EPA's analyses of the 1989-91 CSFII													



Table 11-3. Per Capita Intake of Beef (g/kg-day as consumed)

Population Group	Percent Consuming	Mean	SE	P1	P5	P10	P25	P50	P75	P90	P95	P99	P100
<b>Total</b>	91%	0.825	0.007	0	0	0.055	0.268	0.626	1.163	1.804	2.327	3.478	7.959
<b>Age (years)</b>													
< 01	64%	0.941	0.075	0	0	0	0	0.488	1.417	2.536	3.205	5.776	7.959
01-02	93%	1.46	0.056	0	0	0.187	0.531	1.339	2.166	2.783	3.65	4.741	7.571
03-05	95%	1.392	0.05	0	0	0.14	0.506	1.162	1.905	3.163	3.573	5.908	6.769
06-11	95%	1.095	0.028	0	0.028	0.102	0.337	0.924	1.56	2.376	2.92	3.944	6.024
12-19	95%	0.83	0.02	0	0.032	0.114	0.3	0.654	1.204	1.775	2.192	3.108	4.508
20-39	94%	0.789	0.012	0	0	0.087	0.297	0.644	1.109	1.662	2.165	3.059	6.086
40-69	90%	0.667	0.011	0	0	0.031	0.221	0.536	0.977	1.458	1.76	2.474	4.968
70 +	87%	0.568	0.018	0	0	0	0.151	0.427	0.817	1.324	1.651	2.62	4.02
<b>Season</b>													
Fall	92%	0.834	0.014	0	0	0.063	0.296	0.665	1.167	1.785	2.277	3.339	6.086
Spring	91%	0.797	0.014	0	0	0.046	0.254	0.595	1.132	1.788	2.295	3.531	7.959
Summer	90%	0.845	0.017	0	0	0.045	0.254	0.605	1.187	1.887	2.519	3.707	7.085
Winter	92%	0.823	0.015	0	0	0.066	0.272	0.636	1.157	1.767	2.271	3.266	7.571
<b>Urbanization</b>													
Central City	91%	0.808	0.013	0	0	0.037	0.271	0.611	1.13	1.777	2.329	3.325	6.182
Nonmetropolitan	91%	0.841	0.015	0	0	0.064	0.269	0.637	1.196	1.852	2.308	3.531	6.66
Suburban	92%	0.828	0.011	0	0	0.059	0.265	0.63	1.163	1.797	2.337	3.511	7.959
<b>Race</b>													
Asian	89%	0.895	0.072	0	0	0.08	0.228	0.694	1.251	2.065	2.444	3.135	5.862
Black	87%	0.665	0.019	0	0	0	0.151	0.42	0.963	1.488	2.177	3.126	6.769
Native American	82%	0.995	0.088	0	0	0.016	0.182	0.73	1.299	2.338	2.825	4.958	6.66
Other/NA	90%	1.159	0.069	0	0	0	0.389	0.739	1.63	2.756	3.269	5.908	6.182
White	93%	0.833	0.008	0	0	0.068	0.284	0.651	1.18	1.784	2.28	3.41	7.959
<b>Region</b>													
Midwest	92%	0.853	0.015	0	0	0.07	0.31	0.66	1.191	1.853	2.345	3.65	6.468
Northeast	93%	0.805	0.017	0	0	0.054	0.253	0.595	1.136	1.816	2.352	3.41	6.769
South	90%	0.846	0.013	0	0	0.058	0.268	0.648	1.195	1.805	2.324	3.511	7.959
West	92%	0.775	0.016	0	0	0.039	0.235	0.562	1.105	1.73	2.226	3.219	6.66
NOTE: SE = Standard error P = Percentile of the distribution													
Source: Based on EPA's analyses of the 1989-91 CSFII													



Table 11-4. Per Capita Intake of Pork (g/kg-day as consumed)

Population Group	Percent Consuming	Mean	SE	P1	P5	P10	P25	P50	P75	P90	P95	P99	P100
<b>Total</b>	90.2%	0.261	0.005	0	0	0.005	0.031	0.083	0.263	0.735	1.137	2.384	8.231
<b>Age (years)</b>													
< 01	63.0%	0.291	0.04	0	0	0	0	0.078	0.228	0.69	1.671	3.269	5.431
01-02	92.4%	0.492	0.041	0	0	0.033	0.071	0.182	0.424	1.525	2.633	3.633	6.94
03-05	95.0%	0.473	0.035	0	0	0.021	0.057	0.147	0.362	1.372	2.35	3.309	8.231
06-11	94.5%	0.352	0.018	0	0	0.015	0.052	0.116	0.311	1.098	1.418	2.869	5.024
12-19	94.0%	0.27	0.013	0	0	0.012	0.039	0.09	0.289	0.742	1.118	2.699	5.157
20-39	92.5%	0.23	0.007	0	0	0.009	0.031	0.08	0.233	0.704	1.039	1.747	6.363
40-69	88.3%	0.212	0.007	0	0	0	0.025	0.068	0.242	0.613	0.915	1.865	4.342
70 +	86.5%	0.207	0.011	0	0	0	0.016	0.061	0.223	0.667	0.924	1.74	3.035
<b>Season</b>													
Fall	91.9%	0.254	0.008	0	0	0.01	0.037	0.098	0.267	0.723	1.045	2.118	5.338
Spring	88.8%	0.264	0.009	0	0	0	0.027	0.076	0.265	0.728	1.19	2.762	6.94
Summer	89.4%	0.245	0.01	0	0	0	0.027	0.072	0.22	0.688	1.097	2.43	8.231
Winter	90.6%	0.279	0.009	0	0	0.006	0.032	0.084	0.3	0.819	1.195	2.608	5.946
<b>Urbanization</b>													
Central City	89.5%	0.258	0.009	0	0	0.001	0.027	0.076	0.235	0.736	1.085	2.699	6.94
Nonmetropolitan	90.3%	0.299	0.01	0	0	0.007	0.038	0.099	0.324	0.863	1.212	2.808	8.231
Suburban	90.6%	0.244	0.006	0	0	0.006	0.03	0.078	0.253	0.678	1.098	2.269	5.946
<b>Race</b>													
Asian	85.9%	0.256	0.049	0	0	0.003	0.027	0.057	0.192	0.72	1.157	2.487	3.966
Black	89.2%	0.418	0.019	0	0	0.002	0.035	0.123	0.48	1.19	2.108	3.178	8.231
Native American	83.6%	0.188	0.024	0	0	0	0.027	0.08	0.179	0.473	0.889	1.317	1.662
Other/NA	88.3%	0.191	0.021	0	0	0	0.027	0.075	0.183	0.48	0.845	1.638	5.252
White	90.6%	0.241	0.005	0	0	0.006	0.031	0.081	0.249	0.685	1.061	2.035	5.946
<b>Region</b>													
Midwest	91.3%	0.284	0.009	0	0	0.006	0.034	0.095	0.318	0.776	1.113	2.487	6.362
Northeast	90.4%	0.236	0.01	0	0	0.005	0.027	0.071	0.227	0.699	1.064	2.11	5.338
South	89.5%	0.283	0.008	0	0	0.005	0.032	0.09	0.281	0.802	1.212	2.769	8.231
West	89.7%	0.22	0.009	0	0	0	0.028	0.072	0.198	0.59	1.009	1.944	5.946
NOTE: SE = Standard error P = Percentile of the distribution													
Source: Based on EPA's analyses of the 1989-91 CSFII													



Table 11-5. Per Capita Intake of Poultry (g/kg-day as consumed)

Population Group	Percent Consuming	Mean	SE	P1	P5	P10	P25	P50	P75	P90	P95	P99	P100
<b>Total</b>	91.7%	0.598	0.007	0	0	0.015	0.097	0.344	0.83	1.506	2.035	3.273	12.239
<b>Age (years)</b>													
< 01	64.9%	0.816	0.087	0	0	0	0	0.178	1.07	2.467	3.453	7.373	12.239
01-02	94.2%	1.156	0.064	0	0.017	0.08	0.211	0.636	1.695	2.931	4.144	5.429	11.747
03-05	95.0%	1.068	0.049	0	0	0.044	0.18	0.607	1.647	2.662	3.603	5.024	7.565
06-11	95.7%	0.871	0.028	0	0.022	0.047	0.166	0.556	1.364	2.182	2.851	3.861	6.936
12-19	94.3%	0.558	0.017	0	0	0.02	0.088	0.378	0.813	1.476	1.806	2.394	3.535
20-39	94.6%	0.53	0.01	0	0.005	0.021	0.098	0.332	0.768	1.35	1.744	2.666	3.801
40-69	90.5%	0.477	0.01	0	0	0.011	0.084	0.294	0.696	1.192	1.528	2.358	6.219
70 +	86.7%	0.463	0.017	0	0	0	0.072	0.286	0.692	1.189	1.539	2.284	4.092
<b>Season</b>													
Fall	92.9%	0.635	0.015	0	0	0.022	0.112	0.366	0.867	1.571	2.209	3.543	12.239
Spring	91.0%	0.538	0.013	0	0	0.009	0.071	0.305	0.74	1.368	1.829	3.052	11.543
Summer	90.4%	0.625	0.015	0	0	0.013	0.089	0.359	0.905	1.562	2.171	3.863	6.596
Winter	92.6%	0.595	0.014	0	0	0.025	0.113	0.372	0.82	1.443	1.94	3.091	8.418
<b>Urbanization</b>													
Central City	91.7%	0.627	0.014	0	0	0.011	0.095	0.333	0.877	1.589	2.218	3.518	12.239
Nonmetropolitan	90.6%	0.54	0.013	0	0	0.014	0.093	0.314	0.781	1.321	1.71	3.077	11.543
Suburban	92.4%	0.608	0.011	0	0	0.02	0.1	0.37	0.842	1.542	2.06	3.111	8.306
<b>Race</b>													
Asian	88.6%	0.79	0.068	0	0	0.035	0.112	0.503	1.15	1.901	2.368	2.939	4.745
Black	91.9%	0.798	0.025	0	0	0.02	0.143	0.521	1.133	1.867	2.352	4.288	12.239
Native American	80.7%	0.54	0.051	0	0	0	0.071	0.324	0.985	1.343	1.545	2.348	4.158
Other/NA	91.7%	0.81	0.049	0	0	0.005	0.169	0.467	1.252	2.11	2.695	3.863	4.002
White	92.0%	0.559	0.007	0	0	0.016	0.092	0.318	0.771	1.419	1.906	3.091	11.543
<b>Region</b>													
Midwest	91.7%	0.551	0.014	0	0	0.013	0.095	0.318	0.735	1.328	1.938	3.244	11.747
Northeast	92.7%	0.651	0.017	0	0	0.016	0.093	0.391	0.934	1.687	2.134	3.38	8.306
South	91.7%	0.643	0.012	0	0	0.02	0.106	0.394	0.93	1.581	2.173	3.426	8.418
West	91.0%	0.526	0.014	0	0	0.011	0.086	0.28	0.754	1.33	1.766	2.942	12.239

NOTE: SE = Standard error  
P = Percentile of the distribution  
Source: Based on EPA's analyses of the 1989-91 CSFII





Table 11-6. Per Capita Intake of Game (g/kg-day as consumed)

Population Group	Percent Consuming	Mean	SE	P1	P5	P10	P25	P50	P75	P90	P95	P99	P100
<b>Total</b>	1.2%	0.01	0.01	0	0	0	0	0	0	0	0	0.098	5.081
<b>Age (years)</b>													
< 01	0.5%	0.014	0.091	0	0	0	0	0	0	0	0	1.113	1.866
01-02	0.9%	0.026	0.125	0	0	0	0	0	0	0	0	0.692	2.638
03-05	1.5%	0.01	0.04	0	0	0	0	0	0	0	0	0	2.953
06-11	1.1%	0.004	0.016	0	0	0	0	0	0	0	0	0	1.176
12-19	1.0%	0.004	0.019	0	0	0	0	0	0	0	0	0	1.78
20-39	1.3%	0.01	0.021	0	0	0	0	0	0	0	0	0.098	5.081
40-69	1.3%	0.012	0.017	0	0	0	0	0	0	0	0	0.462	2.882
70 +	1.1%	0.002	0.01	0	0	0	0	0	0	0	0	0	2.261
<b>Season</b>													
Fall	1.7%	0.016	0.022	0	0	0	0	0	0	0	0	0.521	3.488
Spring	0.7%	0.006	0.019	0	0	0	0	0	0	0	0	0	2.882
Summer	0.7%	0.003	0.012	0	0	0	0	0	0	0	0	0	1.78
Winter	1.6%	0.013	0.021	0	0	0	0	0	0	0	0	0.446	5.081
<b>Urbanization</b>													
Central City	0.7%	0.005	0.014	0	0	0	0	0	0	0	0	0	1.8
Nonmetropolitan	2.0%	0.019	0.018	0	0	0	0	0	0	0	0	0.822	1.866
Suburban	1.1%	0.008	0.018	0	0	0	0	0	0	0	0	0	5.081
<b>Race</b>													
Asian	0.0%	0	0	0	0	0	0	0	0	0	0	0	0
Black	0.1%	0.001	0.027	0	0	0	0	0	0	0	0	0	0.887
Native American	0.6%	0.001	0.012	0	0	0	0	0	0	0	0	0	0.255
Other/NA	0.3%	0.003	0.046	0	0	0	0	0	0	0	0	0	0.636
White	1.4%	0.011	0.011	0	0	0	0	0	0	0	0	0.329	5.081
<b>Region</b>													
Midwest	2.2%	0.012	0.012	0	0	0	0	0	0	0	0	0.588	1.866
Northeast	0.5%	0.005	0.026	0	0	0	0	0	0	0	0	0	2.055
South	0.8%	0.009	0.025	0	0	0	0	0	0	0	0	0	5.081
West	1.3%	0.012	0.022	0	0	0	0	0	0	0	0	0.446	2.953
NOTE: SE = Standard error P = Percentile of the distribution													
Source: Based on EPA's analyses of the 1989-91 CSFII													



Table 11-7. Per Capita Intake of Eggs (g/kg-day as consumed)

Population Group	Percent Consuming	Mean	SE	P1	P5	P10	P25	P50	P75	P90	P95	P99	P100
<b>Total</b>	41.4%	0.317	0.009	0	0	0	0	0	0.445	0.968	1.422	2.953	13.757
<b>Age (years)</b>													
< 01	32.3%	0.791	0.126	0	0	0	0	0	1.537	2.744	3.645	5.487	13.757
01-02	43.3%	0.822	0.087	0	0	0	0	0	1.381	2.604	3.299	5.242	8.577
03-05	39.6%	0.677	0.088	0	0	0	0	0	0.89	2.224	3.106	7.475	10.799
06-11	36.6%	0.414	0.033	0	0	0	0	0	0.735	1.312	1.617	3.037	6.331
12-19	36.0%	0.244	0.023	0	0	0	0	0	0.345	0.828	1.26	2.137	4.12
20-39	43.3%	0.271	0.012	0	0	0	0	0	0.439	0.897	1.193	1.764	5.392
40-69	44.0%	0.225	0.009	0	0	0	0	0	0.375	0.725	1.029	1.496	3.216
70 +	42.0%	0.218	0.017	0	0	0	0	0	0.328	0.653	0.969	1.582	2.791
<b>Season</b>													
Fall	40.1%	0.291	0.017	0	0	0	0	0	0.422	0.871	1.237	2.744	6.331
Spring	42.7%	0.307	0.017	0	0	0	0	0	0.402	1.015	1.42	2.604	13.548
Summer	40.5%	0.344	0.02	0	0	0	0	0	0.476	1.035	1.496	3.533	13.757
Winter	42.2%	0.325	0.019	0	0	0	0	0	0.47	0.98	1.409	2.841	11.39
<b>Urbanization</b>													
Central City	41.6%	0.315	0.018	0	0	0	0	0	0.423	0.924	1.422	3.106	13.757
Nonmetropolitan	43.8%	0.338	0.018	0	0	0	0	0	0.493	1.043	1.438	2.826	13.548
Suburban	39.7%	0.309	0.013	0	0	0	0	0	0.434	0.95	1.399	2.73	11.39
<b>Race</b>													
Asian	38.9%	0.452	0.094	0	0	0	0	0	0.615	1.47	2.604	2.672	2.672
Black	48.9%	0.385	0.023	0	0	0	0	0	0.595	1.134	1.486	2.881	6.213
Native American	49.7%	0.491	0.17	0	0	0	0	0	0.457	1.395	1.61	10.799	13.548
Other/NA	55.1%	0.472	0.056	0	0	0	0	0	0.712	1.26	2.247	3.292	5.997
White	39.5%	0.297	0.01	0	0	0	0	0	0.408	0.922	1.368	2.906	13.757
<b>Region</b>													
Midwest	36.9%	0.288	0.019	0	0	0	0	0	0.35	0.893	1.44	3.106	13.548
Northeast	35.9%	0.264	0.02	0	0	0	0	0	0.376	0.791	1.229	2.815	11.39
South	44.3%	0.325	0.014	0	0	0	0	0	0.469	0.999	1.422	2.531	8.737
West	46.6%	0.392	0.022	0	0	0	0	0	0.563	1.135	1.603	3.08	13.757

NOTE: SE = Standard error  
P = Percentile of the distribution

Source: Based on EPA's analyses of the 1989-91 CSFII



Table 11-8. Main Daily Intake of Meat and Dairy Products Per Individual in a Day for USDA 1977-78, 87-88, 89-91, 94, and 95 Surveys

Food Product	77-78 Data (g-day)	87-88 Data (g/day)	89-91 Data (g/day)	94 Data (g/day)	95 Data (g/day)
Beef	52	32	26	24	27
Poultry	25	26	27	29	24
Meat Mixtures <sup>1</sup>	69	86	90	95	104
Dairy Products <sup>2</sup>	314	290	286	277	284

<sup>1</sup> Includes mixtures having meat, poultry, or fish as a main ingredient; frozen meals in which the main course is a meat, poultry, or fish item; meat, poultry, or fish sandwiches coded as a single item; and baby-food meat and poultry mixtures.

<sup>2</sup> Includes total milk, cream, milk desserts, and cheese. Total milk includes fluid milk, yogurt, flavored milk, milk drinks, meal replacements with milk, milk-based infant formulas, and unreconstituted dry milk and powdered mixtures.

Sources: USDA, 1980; 1992; 1996a; 1996b.



Table 11-9. Mean Per Capita Intake Rates for Meat, Poultry, and Dairy Products (g/kg-d as consumed)  
Based on All Sex/Age/Demographic Subgroups

Raw Agricultural Commodity <sup>a</sup>	Average Consumption (Grams/kg Body Weight/Day)	Standard Error
Milk-Non-Fat Solids	0.9033354	0.0134468
Milk-Non-Fat Solids (Food additive)	0.9033354	0.0134468
Milk-Fat Solids	0.4297199	0.0060264
Milk-Fat Solids (Food additive)	0.4297199	0.0060264
Milk Sugar (Lactose)	0.0374270	0.0033996
Beef-Meat Byproducts	0.0176621	0.0005652
Beef (Organ Meats) - Other	0.0060345	0.0007012
Beef - Dried	0.0025325	0.0004123
Beef (Boneless) - Fat (Beef Tallow)	0.3720755	0.0048605
Beef (Organ Meats) - Kidney	0.0004798	0.0003059
Beef (Organ Meats) - Liver	0.0206980	0.0014002
Beef (Boneless) - Lean (w/o Removeable Fat)	1.1619987	0.0159453
Goat-Meat Byproducts	0.0000000	NA
Goat (Organ Meats) - Other	0.0000000	NA
Goat (Boneless) - Fat	0.0000397	0.0000238
Goat (Organ Meats) - Kidney	0.0000000	NA
Goat (Organ Meats) - Liver	0.0000000	NA
Goat (Boneless) - Lean (w/o Removeable Fat)	0.0001891	0.0001139
Horse	0.0000000	NA
Rabbit	0.0014207	0.00003544
Sheep - Meat Byproducts	0.0000501	0.0000381
Sheep (Organ Meats) - Other	0.0000109	0.0000197
Sheep (Boneless) - Fat	0.0042966	0.0005956
Sheep (Organ Meats) - Kidney	0.0000090	0.0000079
Sheep (Organ Meats) - Liver	0.0000000	NA
Sheep (Boneless) - Lean (w/o Removeable Fat)	0.0124842	0.0015077
Pork - Meat Byproducts	0.0250792	0.0022720
Pork (Organ Meats) - Other	0.0038496	0.0003233
Pork (Boneless) - Fat (Including Lard)	0.2082022	0.0032032
Pork (Organ Meats) - Kidney	0.0000168	0.0000106
Pork (Organ Meats) - Liver	0.0048194	0.0004288
Pork (Boneless) - Lean (w/o Removeable Fat)	0.3912467	0.0060683
Meat, Game	0.0063507	0.0010935
Turkey - Byproducts	0.0002358	0.0000339
Turkey - Giblets (Liver)	0.0000537	0.0000370
Turkey - Flesh (w/o Skin, w/o Bones)	0.0078728	0.0007933
Turkey - Flesh (+ Skin, w/o Bones)	0.0481655	0.0026028
Turkey - Unspecified	0.0000954	0.0000552
Poultry, Other - Byproducts	0.0000000	NA
Poultry, Other - Giblets (Liver)	0.0002321	0.0001440
Poultry, Other - Flesh (+ Skin, w/o Bones)	0.0053882	0.0007590
Eggs - Whole	0.5645020	0.0076651
Eggs - White Only	0.0092044	0.0004441
Eggs - Yolk Only	0.0066323	0.0004295
Chicken - Byproducts	0.0000000	NA
Chicken - Giblets (Liver)	0.0050626	0.0005727
Chicken - Flesh (w/o Skin, w/o Bones)	0.0601361	0.0021616
Chicken - Flesh (+ Skin, w/o Bones)	0.3793205	0.0104779

NA = Not applicable  
<sup>a</sup> Consumed in any raw or prepared form.  
 Source: DRES database (based on 1977-78 NFCS)



Table 11-10. Mean Meat Intakes Per Individual in a Day, by Sex and Age (g/day as consumed)<sup>a</sup> for 1977-1978

Group Age (yrs.)	Total Meat, Poultry and Fish	Beef	Pork	Lamb, Veal, Game	Frankfurters, Sausages, Luncheon Meats, Spreads	Total Poultry	Chicken Only	Meat Mixtures <sup>c</sup>
<u>Males and Females</u>								
1 and Under	72	9	4	3	2	4	1	51
1-2	91	18	6	(b)	15	16	13	32
3-5	121	23	8	(b)	15	19	19	49
6-8	149	33	15	1	17	20	19	55
<u>Males</u>								
9-11	188	41	22	3	19	24	21	71
12-14	218	53	18	(b)	25	27	24	87
15-18	272	82	24	1	25	37	32	93
19-22	310	90	21	2	33	45	43	112
23-34	285	86	27	1	30	31	29	94
35-50	295	75	28	1	26	31	28	113
51-64	274	70	32	1	29	31	29	86
65-74	231	54	25	2	22	29	26	72
75 and Over	196	41	39	7	19	28	25	54
<u>Females</u>								
9-11	162	38	17	1	20	27	23	55
12-14	176	47	19	1	18	23	22	61
15-18	180	46	14	2	16	28	27	61
19-22	184	52	19	1	18	26	24	61
23-34	183	48	17	1	16	24	22	66
35-50	187	49	19	2	14	24	21	63
51-64	187	52	19	2	12	26	24	60
65-74	159	34	21	4	12	30	25	47
75 and Over	134	31	17	2	9	19	16	49
<u>Males and Females</u>								
All Ages	207	54	20	2	20	27	24	72

<sup>a</sup> Based on USDA Nationwide Food Consumption Survey 1977-78 data for one day.

<sup>b</sup> Less than 0.5 g/day but more than 0.

<sup>c</sup> Includes mixtures containing meat, poultry, or fish as a main ingredient.

Source: USDA, 1980.

Table 11-11. Mean Meat Intakes Per Individual in a Day, by Sex and Age (g/day as consumed)<sup>a</sup> for 1987-1988

Group Age (yrs.)	Total Meat, Poultry, and Fish	Beef	Pork	Lamb, Veal, Game	Frankfurters, Sausages, Luncheon Meats	Total Poultry	Chicken Only	Meat Mixtures <sup>b</sup>
<u>Males and Females</u>								
5 and Under	92	10	9	<0.5	11	14	12	39
<u>Males</u>								
6-11	156	22	14	<0.5	13	27	24	74
12-19	252	38	17	1	20	27	20	142
20 and over	250	44	19	23	2	31	25	108
<u>Females</u>								
6-11	151	26	9	1	11	20	17	74
12-19	169	31	10	<0.5	18	17	13	80
20 and over	170	29	12	1	13	24	18	73
All individuals	193	32	14	1	17	26	20	86

<sup>a</sup> Based on USDA Nationwide Food Consumption Survey 1987-88 data for one day.

<sup>b</sup> Includes mixtures containing meat, poultry, or fish as a main ingredient.

Source: USDA, 1992.



Table 11-12. Mean Dairy Product Intakes Per Individual in a Day, by Sex and Age (g/day as consumed)<sup>a</sup> for 1977-1978

Group Age (yrs.)	Total Milk	Fluid Milk	Cheese	Eggs
1 and Under	618	361	1	5
1-2	404	397	8	20
3-5	353	330	9	22
6-8	433	401	10	18
9-11	432	402	8	26
12-14	504	461	9	28
15-18	519	467	13	31
19-22	388	353	15	32
23-34	243	213	21	38
35-50	203	192	18	41
51-64	180	173	17	36
65-74	217	204	14	36
75 and Over	193	184	18	41
9-11	402	371	7	14
12-14	387	343	11	19
15-18	316	279	11	21
19-22	224	205	18	26
23-34	182	158	19	26
35-50	130	117	18	23
51-64	139	128	19	24
65-74	166	156	14	22
75 and Over	214	205	20	19
All Ages	266	242	15	27

<sup>a</sup> Based on USDA Nationwide Food Consumption Survey 1977-78 data for one day.  
Source: USDA, 1980.

Table 11-13. Mean Dairy Product Intakes Per Individual in a Day, by Sex and Age (g/day as consumed)<sup>a</sup> for 1987-1988

Group Age (yrs.)	Total Fluid Milk	Whole Milk	Lowfat/Skim Milk	Cheese	Eggs
Males and Females					
5 and under	347	177	129	7	11
Males					
6-11	439	224	159	10	17
12-19	392	183	168	12	17
20 and over	202	88	94	17	27
Females					
6-11	310	135	135	9	14
12-19	260	124	114	12	18
20 and over	148	55	81	15	17
All individuals	224	99	102	14	20

<sup>a</sup> Based on USDA Nationwide Food Consumption Survey 1987-88 data for one day.  
Source: USDA, 1992.



Table 11-14. Mean Meat Intakes Per Individual in a Day, by Sex and Age (g/day as consumed) for 1994 and 1995

Group Age (yrs.)	Total Meat, Poultry, and Fish		Beef		Pork		Lamb, Veal, Game		Frankfurters, Sausages, Luncheon Meats		Total Poultry		Chicken Only		Meat Mixtures <sup>c</sup>	
	1994	1995	1994	1995	1994	1995	1994	1995	1994	1995	1994	1995	1994	1995	1994	1995
	Males and Females															
5 and Under	94	87	10	8	6	4	(b)	(b)	17	18	16	15	14	14	41	39
Males																
6-11	131	161	19	18	9	7	0	(b)	22	27	19	25	16	22	51	68
12-19	238	256	31	29	11	11	1	1	21	27	40	26	29	23	119	150
20 and over	266	283	35	41	17	14	2	1	29	27	39	31	30	27	124	149
Females																
6-11	117	136	18	16	5	5	(b)	(b)	18	20	19	17	15	14	51	69
12-19	164	158	23	22	5	7	(b)	0	16	10	20	19	15	18	94	82
20 and over	168	167	18	21	9	11	1	1	16	15	25	22	20	19	87	83
All individuals	195	202	24	27	11	10	1	1	21	21	29	24	23	21	98	104

<sup>a</sup> Based on USDA CSFII 1994 and 1995 data for one day.  
<sup>b</sup> Less than 0.5 g/day but more than 0.  
<sup>c</sup> Includes mixtures containing meat, poultry, or fish as a main ingredient.  
Source: USDA, 1996a; 1996b.

Table 11-15. Mean Dairy Product Intakes Per Individual in a Day, by Sex and Age (g/day as consumed) for 1994 and 1995

Group Age (yrs.)	Total Fluid Milk		Whole Milk		Lowfat Milk		Cheese		Eggs	
	1994	1995	1994	1995	1994	1995	1994	1995	1994	1995
	Males and Females									
5 and under	424	441	169	165	130	129	12	9	11	13
Males										
6-11	407	400	107	128	188	164	11	12	13	15
12-19	346	396	105	105	160	176	19	20	18	24
20 and over	195	206	50	57	83	88	19	16	23	23
Females										
6-11	340	330	101	93	136	146	17	13	12	15
12-19	239	235	75	71	88	107	14	13	13	17
20 and over	157	158	37	32	56	57	16	15	15	16
All individuals	229	236	65	66	89	92	17	15	17	19

<sup>a</sup> Based on USDA CSFII 1994 and 1995 data for one day.  
Source: USDA, 1996a; 1996b.



Table 11-16. Mean and Standard Error for the Dietary Intake of Food Sub Classes Per Capita by Age (g/day as consumed)

Age (yrs.)	Fresh Cows' Milk	Other Dairy Products	Eggs	Beef	Pork	Poultry	Other Meat
All Ages	253.5 ± 4.9	55.1 ± 1.2	26.9 ± 0.5	87.6 ± 1.1	28.2 ± 0.6	31.3 ± 0.8	25.1 ± 0.4
<1	272.0 ± 31.9	296.7 ± 7.6	4.9 ± 3.2	18.4 ± 7.4	5.8 ± 3.6	18.4 ± 4.9	2.6 ± 2.8
1-4	337.3 ± 15.6	41.0 ± 3.7	19.8 ± 1.6	42.2 ± 3.7	13.6 ± 1.8	19.0 ± 2.4	17.6 ± 1.4
5-9	446.2 ± 13.1	47.3 ± 3.1	17.0 ± 1.3	63.4 ± 3.1	18.2 ± 1.5	24.7 ± 2.0	22.3 ± 1.2
10-14	456.0 ± 12.3	53.3 ± 2.9	19.3 ± 1.2	81.9 ± 2.9	22.2 ± 1.4	30.0 ± 1.9	26.1 ± 1.1
15-19	404.8 ± 12.9	52.9 ± 3.1	24.8 ± 1.3	99.5 ± 3.0	29.5 ± 1.5	33.0 ± 2.0	27.6 ± 1.1
20-24	264.3 ± 16.4	44.2 ± 4.0	28.3 ± 1.7	103.7 ± 3.9	29.6 ± 1.9	33.0 ± 2.6	28.8 ± 1.5
25-29	217.6 ± 17.2	51.5 ± 4.1	27.9 ± 1.7	103.8 ± 4.0	31.8 ± 2.0	33.8 ± 2.7	28.9 ± 1.5
30-39	182.9 ± 13.5	53.8 ± 3.2	30.1 ± 1.4	105.8 ± 3.2	33.0 ± 1.5	34.0 ± 2.1	28.4 ± 1.2
40-59	169.1 ± 10.5	52.0 ± 2.5	31.1 ± 1.0	99.0 ± 2.5	33.5 ± 1.2	33.8 ± 1.6	27.4 ± 0.9
≥60	192.4 ± 11.8	55.9 ± 2.8	28.7 ± 1.2	74.3 ± 2.8	27.5 ± 1.3	31.5 ± 1.8	21.1 ± 1.0

Source: U.S. EPA, 1984a (based on 1977-78 NFCS).

Table 11-17. Mean and Standard Error for the Per Capita Daily Intake of Food Class and Sub Class by Region (g/day as consumed)

	US Population	Northeast	North Central	South	West
<u>Dairy Products (Total)</u>	308.6 ± 5.3	318.6 ± 10.4	336.1 ± 10.0	253.6 ± 8.4	348.1 ± 12.3
Fresh Cows Milk	253.5 ± 4.9	256.1 ± 9.7	279.7 ± 9.4	211.0 ± 7.8	283.5 ± 11.5
Other	55.1 ± 1.2	62.5 ± 2.3	56.5 ± 2.2	42.6 ± 1.9	64.6 ± 2.7
<u>Eggs</u>	26.9 ± 0.5	23.8 ± 1.0	23.5 ± 0.9	31.0 ± 0.8	29.1 ± 1.2
<u>Meats (Total)</u>	172.2 ± 1.6	169.9 ± 3.3	176.9 ± 3.1	171.9 ± 2.6	168.6 ± 3.9
Beef and Veal	87.6 ± 1.1	82.3 ± 2.3	92.9 ± 2.2	84.0 ± 1.8	92.9 ± 2.7
Pork	28.2 ± 0.6	28.8 ± 1.1	29.6 ± 1.1	30.1 ± 0.9	22.1 ± 1.3
Poultry	31.3 ± 0.8	31.7 ± 1.5	26.6 ± 1.4	36.5 ± 1.2	28.9 ± 1.8
Other	25.1 ± 0.4	27.1 ± 0.9	27.8 ± 0.8	21.3 ± 0.7	24.7 ± 1.0

NOTE: Northeast = Maine, New Hampshire, Vermont, Massachusetts, Connecticut, Rhode Island, New York, New Jersey, and Pennsylvania.  
 North Central = Ohio, Illinois, Indiana, Wisconsin, Michigan, Minnesota, Iowa, Missouri, North Dakota, South Dakota, Nebraska, and Kansas.  
 South = Maryland, Delaware, District of Columbia, Virginia, West Virginia, North Carolina, South Carolina, Georgia, Florida, Kentucky, Tennessee, Alabama, Mississippi, Arkansas, Louisiana, Texas, and Oklahoma.  
 West = Montana, Idaho, Wyoming, Utah, Colorado, New Mexico, Arizona, Nevada, Washington, Oregon, and California.

Source: U.S. EPA, 1984b (based on 1977-78 NFCS).





Table 11-18. Consumption of Meat, Poultry, and Dairy Products for Different Age Groups (averaged across sex), and Estimated Lifetime Average Intakes for 70 Kg Adult Citizens Calculated from the FDA Diet Data.

Produce	Baby (0-1 yrs)	Toddler 1-6 yrs)	Child (6-14 yrs)	Teen (14-20 yrs)	Adult (20-45 yrs)	Old (45-70 yrs)	Estimated Lifetime Intake <sup>a</sup>
g - dry weight/day							
Beef	3.99	9.66	15.64	21.62	23.28	18.34	19.25
Beef Liver	0.17	0.24	0.30	0.36	1.08	1.2	0.89
Lamb	0.14	0.08	0.06	0.05	0.30	0.21	0.20
Pork	1.34	4.29	6.57	8.86	10.27	9.94	9.05
Poultry	2.27	3.76	5.39	7.03	7.64	6.87	6.70
Dairy	40.70	32.94	38.23	43.52	27.52	22.41	28.87
Eggs	3.27	6.91	7.22	7.52	8.35	9.33	8.32
Beef Fat	2.45	6.48	11.34	16.22	20.40	14.07	15.50
Beef Liver Fat	0.05	0.07	0.08	0.10	0.29	0.33	0.25
Lamb Fat	0.14	0.08	0.07	0.06	0.31	0.22	0.21
Dairy Fat	38.99	16.48	20.46	24.43	18.97	14.51	18.13
Pork Fat	2.01	8.19	10.47	12.75	14.48	13.04	12.73
Poultry Fat	1.10	0.83	1.12	1.41	1.54	1.31	1.34

<sup>a</sup> The estimated lifetime dietary intakes were estimated by:

$$\text{Estimated lifetime intake} = \frac{\text{IR}(0-1) + 5\text{yrs} * \text{IR}(1-5) + 8\text{yrs} * \text{IR}(6-13) + 6\text{yrs} * \text{IR}(14-19) + 25\text{yrs} * \text{IR}(20-44) + 25\text{yrs} * \text{IR}(45-70)}{70\text{ years}}$$

where IR = the intake rate for a specific age group.

Source: U.S. EPA, 1989 (based in 1977-78 NFCS and NHANES II data).

Table 11-19. Per Capita Consumption of Meat and Poultry in 1991<sup>a</sup>

Food Item	Per Capita Consumption Carcass <sup>b</sup>	Per Capita Consumption	Per Capita Consumption Retail Cut	Per Capita Consumption Boneless
	Weight (g/day) <sup>f</sup>	RTC <sup>c</sup> (g/day) <sup>f</sup>	Equivalent <sup>d</sup> (g/day) <sup>f</sup>	Trimmed Equivalent <sup>e</sup> (g/day) <sup>f</sup>
<b>Red Meat</b>				
Beef	118.3	---	82.8	78.4
Veal	1.5	---	1.2	0.99
Pork	8.0	---	62.1	58.3
Lamb and Mutton	2.0	---	1.7	1.2
Total <sup>g</sup>	201.7	---	147.9	139.1
<b>Poultry</b>				
Young Chicken	---	---	78.3	---
Other Chicken	---	---	1.7	---
Chicken	---	91.3	---	54.5 <sup>h,i</sup>
Turkey	---	22.2	---	17.5 <sup>h</sup>
Total <sup>g</sup>	---	109.2	77.0	72.1

<sup>a</sup> Includes processed meats and poultry in a fresh basis; excludes shipments to U.S. territories; uses U.S. total population, July 1, and does not include residents of the U.S. territories.

<sup>b</sup> Beef-Carcass-Weight is the weight of the chilled hanging carcass, which includes the kidney and attached internal fat [kidney, pelvic, and heart fat (kph)] but not head, feet, and unattached internal organs. Definitions of carcass weight for other red meats differ slightly.

<sup>c</sup> RTC - ready-to-cook poultry weight is the entire dressed bird which includes bones, skin, fat, liver, heart, gizzard, and neck.

<sup>d</sup> Retail equivalents in 1991 were converted from carcass weight by multiplying by a factor of 0.7, 0.83, 0.89, and 0.776 for beef, veal, lamb, and pork, respectively; 0.877 was the factor used each for young chicken and other chicken.

<sup>e</sup> Boneless equivalent for red meat derived from carcass weight in 1991 by using conversion factors of 0.663, 0.685, 0.658 and 0.729 for beef, veal, lamb, and pork, respectively; 0.597, 0.597 and 0.790 were the factors used for young chicken, other chicken, and turkey.

<sup>f</sup> Original data were presented in lbs; converted to g/day by multiplying by a factor of 453.6 g/lb and dividing by 365 days/yr.

<sup>g</sup> Computed from unrounded data.

<sup>h</sup> Includes skin, neck, and giblets.

<sup>i</sup> Excludes amount of RTC chicken going to pet food as well as some water leakage that occurs when chicken is cut-up before packaging.

Source: USDA, 1993.



Table 11-20. Per Capita Consumption of Dairy Products in 1991<sup>a</sup>

Food Item	Per Capita Consumption (g/day) <sup>j</sup>	Food Item	Per Capita Consumption (g/day) <sup>j</sup>
<u>Eggs</u>		<u>Cheese</u>	
Farm Weight <sup>b,e</sup>	37.8	American	
Retail Weight <sup>c,e</sup>	37.3	Cheddar	11.2
		Other <sup>d</sup>	2.5
<u>Fluid Milk and Cream</u>	289.7	Italian	
Plain Whole Milk	105.3	Provolone	0.8
Lowfat Plain Milk (2%)	98.1	Romano	0.2
Lowfat Plain Milk (1%)	25.8	Parmesan	0.6
Skim Plain Milk	29.7	Mozzarella	9.0
Whole Flavored Milk and Drink	3.4	Ricotta	1.0
Lowfat Flavored Milk and Drink	8.5	Other	0.07
Buttermilk (lowfat and skim)	4.2	Miscellaneous	
Half and Half Cream	3.9	Swiss <sup>f</sup>	1.5
Light Cream	0.4	Brick	0.07
Heavy Cream	1.6	Muenster	0.5
Sour Cream	3.2	Cream	1.9
Eggnog	0.5	Neufchatel	0.3
		Blue <sup>g</sup>	0.2
<u>Evaporated and Condensed Milk<sup>i</sup></u>		Other	1.2
Canned Whole Milk	2.6	Processed Products	
Bulk Whole Milk	1.4	Cheese	6.1
Bulk and Canned Skim Milk	6.2	Foods and spreads	4.7
Total <sup>e</sup>	10.2	Cheese Content	8.5
		Consumed as Natural	22.6
<u>Dry Milk Products<sup>i</sup></u>		Cottage Cheese (lowfat)	1.6
Dry Whole Milk	0.5		
Nonfat Dry Milk	3.2	<u>Frozen Dairy Products</u>	
Dry Buttermilk	0.3	Ice Cream	20.3
Total <sup>e</sup>	4.0	Ice Milk	9.2
Dried Whey	4.5	Sherbet	1.5
		Other Frozen Products <sup>h</sup>	5.3
<u>Butter</u>	5.2	Total <sup>e</sup>	36.4
		<u>All Dairy Products</u>	
		USDA Donations	17.1
		Commercial Sales	685.2
		Total	702.4

<sup>a</sup> All per capita consumption figures use U.S. total populations, except fluid milk and cream data, which are based on U.S. residential population. For eggs, excludes shipments to U.S. territories, uses U.S. total population, July 1, which does not include U.S. territories.

<sup>b</sup> A dozen eggs converted at 1.57 pounds.

<sup>c</sup> The factor for converting farm weight to retail weight was 0.97 in 1960 and was increased 0.003 per year until 0.985 was reached in 1990.

<sup>d</sup> Includes Colby, washed curd, Monterey, and Jack.

<sup>e</sup> Computed from unrounded data.

<sup>f</sup> Includes imports of Gruyere and Emmenthaler.

<sup>g</sup> Includes Gorgonzola.

<sup>h</sup> Includes mellorine, frozen yogurt beginning 1981, and other nonstandardized frozen dairy products.

<sup>i</sup> Includes quantities used in other dairy products.

<sup>j</sup> Original data were presented in lbs, conversions to g/day were calculated by multiplying by a factor of 453.6 and dividing by 365 days.

Source: USDA, 1993.



Table 11-21. Adult Mean Daily Intake (as consumed) of Meat and Poultry Grouped by Region and Gender<sup>a</sup>

Food Item	Mean Daily Intake (g/day)									
	Region									
	Pacific		Mountain		North Central		Northeast		South	
	Male	Female	Male	Female	Male	Female	Male	Female	Male	Female
Beef	84.8	52.8	89.8	59.6	86.8	55.9	71.8	46.6	87.3	54.9
Pork	18.6	12.6	23.7	16.8	26.5	18.8	22.4	15.9	24.4	17.2
Lamb	1.3	1.2	0.5	0.3	0.4	0.4	1.3	1.0	0.5	0.3
Veal	0.4	0.2	0.2	0.2	0.4	0.4	2.8	1.5	0.3	0.3
Variety										
Meats/Game	11.1	7.9	9.1	7.4	11.9	8.0	8.1	6.8	9.4	7.8
Processed Meats	22.8	15.4	22.9	13.2	26.3	15.8	21.2	15.5	26.0	17.0
Poultry	67.3	56.1	51.0	45.2	51.7	44.7	56.2	49.2	57.7	50.2

<sup>a</sup> Adult population represents consumers ages 19 and above.

NOTE: Pacific = Washington, Oregon and California

Mountain = Montana, Idaho, Wyoming, Utah, Colorado, New Mexico, Arizona, and Nevada

North Central = Ohio, Illinois, Indiana, Wisconsin, Michigan, Minnesota, Iowa, Missouri, North Dakota, South Dakota, Nebraska, and Kansas.

Northeast = Maine, New Hampshire, Vermont, Massachusetts, Connecticut, Rhode Island, New York, New Jersey, and Pennsylvania.

South = Maryland, Delaware, District of Columbia, Virginia, West Virginia, North Carolina, South Carolina, Georgia, Florida, Kentucky, Tennessee, Alabama, Mississippi, Arkansas, Louisiana, Texas, and Oklahoma.

Source: National Livestock and Meat Board, 1993.

Table 11-22. Amount (as consumed) of Meat Consumed by Adults Grouped by Frequency of Eatings<sup>e</sup>

Frequency of Eatings	Percent of Total Eaters	Percent of Eaters		Total Consumption for 14 Days (g)	Median Daily Intake (g/day)
		Male	Female		
Non-Meat Eaters <sup>a</sup>	1%	20	80	None	None
Light Meat Eaters <sup>b</sup>	30%	27	73	<1025	54
Medium Meat Eaters <sup>c</sup>	33%	39	61	1025-1584	93
Heavy Meat Eaters <sup>d</sup>	36%	73	27	>1548	144

<sup>a</sup> A female who is employed and on a diet. She lives alone or in a small household (without children).

<sup>b</sup> Female who may or may not be on a diet. There are probably 2-4 people in her household but that number is not likely to include children.

<sup>c</sup> This person may be of either sex, might be on a diet, and probably lives in a household of 2-4 people, which may include children.

<sup>d</sup> Male who is not on a diet and lives in a household of 2-4 individuals, which may include children.

<sup>e</sup> Adult population represents consumers ages 19 and above.

Source: National Livestock and Meat Board, 1993.



Table 11-23. Quantity (as consumed) of Meat, Poultry, and Dairy Products Consumed Per Eating Occasion and the Percentage of Individuals Using These Foods in Three Days

Food category	% Indiv. using food in 3 days	Quantity consumed per eating occasion (g)		Consumers-only Quantity consumed per eating occasion at Specified Percentiles (g)						
		Average	Standard Deviation	5	25	50	75	90	95	99
Meat <sup>a</sup>	84.6	107	85	16	46	86	140	224	252	432
Beef	67.3	133	85	41	84	112	168	224	280	448
Pork	49.9	69	69	8	16	44	92	160	194	320
Lamb	1.5	146	84	43	88	123	184	227	280	448
Veal	2.3	130	71	42	84	112	168	224	276	352
Poultry	42.8	128	77	42	82	112	168	224	280	388
Chicken	38.7	131	76	43	84	112	170	224	280	388
Turkey	5.8	105	73	28	57	86	129	172	240	350
<u>Dairy Products</u>										
Eggs	54.3	82	44	40	50	64	100	128	150	237
Butter	31.4	12	13	2	5	7	14	28	28	57
Margarine	43.1	11	11	2	5	7	14	28	28	57
Milk <sup>b</sup>	82.5	203	134	15	122	244	245	366	488	552
Cheese <sup>c</sup>	40	41	28	14	28	28	56	58	85	140

<sup>a</sup> Meat - beef, pork, lamb, and veal.

<sup>b</sup> Milk - fluid milk, milk beverages, and milk-based infant formulas.

<sup>c</sup> Cheese - natural and processed cheese.

Source: Pao et al., 1982 (based on 1977-78 NFCS).



Table 11-24. Percentage Lipid Content (Expressed as Percentages of 100 Grams of Edible Portions) of Selected Meat and Dairy Products<sup>a</sup>

Product	Fat Percentage	Comment
<u>Meats</u>		
<b>Beef</b>		
Lean only	6.16	Raw
Lean and fat, 1/4 in. fat trim	9.91	Cooked
<b>Brisket (point half)</b>		
Lean and fat	19.24	Raw
	21.54	Cooked
<b>Brisket (flat half)</b>		
Lean and fat	22.40	Raw
Lean only	4.03	Raw
<b>Pork</b>		
Lean only	5.88	Raw
	9.66	Cooked
Lean and fat	14.95	Raw
	17.18	Cooked
Cured shoulder, blade roll, lean and fat	20.02	Unheated
Cured ham, lean and fat	12.07	Center slice
Cured ham, lean only	7.57	Raw, center, country style
Sausage	38.24	Raw, fresh
Ham	4.55	Cooked, extra lean (5% fat)
Ham	9.55	Cooked, (11% fat)
<b>Lamb</b>		
Lean	5.25	Raw
	9.52	Cooked
Lean and fat	21.59	Raw
	20.94	Cooked
<b>Veal</b>		
Lean	2.87	Raw
	6.58	Cooked
Lean and fat	6.77	Raw
	11.39	Cooked
<b>Rabbit</b>		
Composite of cuts	5.55	Raw
	8.05	Cooked
<b>Chicken</b>		
Meat only	3.08	Raw
	7.41	Cooked
Meat and skin	15.06	Raw
	13.60	Cooked
<b>Turkey</b>		
Meat only	2.86	Raw
	4.97	Cooked
Meat and skin	8.02	Raw
	9.73	Cooked
Ground	6.66	Raw



Chapter 11 - Intake of Meat and Dairy Products

Table 11-24. Percentage Lipid Content (Expressed as Percentages of 100 Grams of Edible Portions) of Selected Meat and Dairy Products <sup>a</sup> (continued)		
Product	Fat Percentage	Comment
<u>Dairy</u>		
Milk		
Whole	3.16	3.3% fat, raw or pasteurized
Human	4.17	Whole, mature, fluid
Lowfat (1%)	0.83	Fluid
Lowfat (2%)	1.83	Fluid
Skim	0.17	Fluid
Cream		
Half and half	18.32	Table or coffee, fluid
Medium	23.71	25% fat, fluid
Heavy-whipping	35.09	Fluid
Sour	19.88	Cultured
Butter	76.93	Regular
Cheese		
American	29.63	Pasteurized
Cheddar	31.42	
Swiss	26.02	
Cream	33.07	
Parmesan	24.50; 28.46	Hard; grated
Cottage	1.83	Lowfat, 2% fat
Colby	30.45	
Blue	27.26	
Provolone	25.24	
Mozzarella	20.48	
Yogurt	1.47	Plain, lowfat
Eggs	8.35	Chicken, whole raw, fresh or frozen
<sup>a</sup> Based on the lipid content in 100 grams, edible portion. Source: USDA, 1979-1984.		

Table 11-25. Fat Content of Meat Products		
Meat Product	Total Fat	Percent Fat
3-oz cooked serving (85.05 g)	(g)	Content (%)
Beef, retail composite, lean only	8.4	9.9
Pork, retail composite, lean only	8.0	9.4
Lamb, retail composite, lean only	8.1	9.5
Veal, retail composite, lean only	5.6	6.6
Broiler chicken, flesh only	6.3	7.4
Turkey, flesh only	4.2	4.9
Source: National Livestock and Meat Board, 1993		



Table 11-26. Fat Intake, Contribution of Various Food Groups to Fat Intake, and Percentage of the Population in Various Meat Eater Groups of the U.S. Population

	Total Population	Heavy Meat Eaters	Medium Meat Eaters	Light Meat Eaters	Non-Meat Eaters
Average Fat Intake (g)	68.3	84.5	62.5	53.5	32.3
Percent of Population	100	36	33	30	1
Meat Group (%) <sup>a</sup>	41	44	40	37	33
Bread Group (%)	24	23	24	26	25
Milk Group (%)	12	11	13	14	14
Fruits (%)	1	1	1	1	1
Vegetables (%)	9	9	9	9	11
Fats/oil/sweets (%)	13	12	13	14	17

<sup>a</sup> Meat Group includes meat, poultry, dry beans, eggs, and nuts.  
Source: National Livestock and MeatBoard, 1993.

Table 11-27. Mean Total Daily Dietary Fat Intake (g/day) Grouped by Age and Gender<sup>a</sup>

Age (yrs)	N	Total	Males		Females	
		Mean Fat Intake (g/day)	N	Mean Fat Intake (g/day)	N	Mean Fat Intake (g/day)
2-11 (months)	871	37.52	439	38.31	432	36.95
1-2	1,231	49.96	601	51.74	630	48.33
3-5	1,647	60.39	744	70.27	803	61.51
6-11	1,745	74.17	868	79.45	877	68.95
12-16	711	85.19	338	101.94	373	71.23
16-19	785	100.50	308	123.23	397	77.46
20-29	1,882	97.12	844	118.28	638	76.52
30-39	1,628	93.84	736	114.28	791	74.06
40-49	1,228	84.90	626	99.26	602	70.80
50-59	929	79.29	473	96.11	456	63.32
60-69	1,108	69.15	646	80.80	560	59.52
70-79	851	61.44	444	73.35	407	53.34
≥ 80	809	54.61	290	68.09	313	47.84
Total	14,801	81.91	7,322	97.18	7,479	67.52
≥ 2	13,314	82.77	6,594	98.74	8,720	68.06

<sup>a</sup> Total dietary fat intake includes all fat (i.e., saturated and unsaturated) derived from consumption of foods and beverages (excluding plain drinking water).  
Source: Adapted from CDC, 1994.



Table 11-28. Percentage Mean Moisture Content (Expressed as Percentages of 100 Grams of Edible Portions)<sup>a</sup>

Food	Moisture Content Percent	Comments
<u>Meat</u>		
Beef	71.60	Raw, composite, trimmed, retail cuts
Beef liver	68.99	Raw
Chicken (light meat)	74.86	Raw, without skin
Chicken (dark meat)	75.99	Raw, without skin
Duck - domestic	73.77	Raw
Duck - wild	75.51	Raw
Goose - domestic	68.30	Raw
Ham - cured	66.92	Raw
Horse	72.63	Raw, roasted
	63.98	Cooked, roasted
Lamb	73.42	Raw, composite, trimmed, retail cuts
Lard	0.00	
Pork	70.00	Raw
Rabbit - domestic	72.81	Raw
	69.11	Raw, roasted
Turkey	74.16	Cooked, roasted
<u>Dairy Products</u>		
Eggs	74.57	Raw
Butter	15.87	Raw
Cheese - American pasteurized	39.16	Regular
Cheddar	36.75	
Swiss	37.21	
Parmesan, hard	29.16	
Parmesan, grated	17.66	
Cream, whipping, heavy	57.71	
Cottage, lowfat	79.31	
Colby	38.20	
Blue	42.41	
Cream	53.75	
Yogurt		
Plain, lowfat	85.07	
Plain, with fat	87.90	Made from whole milk
Human milk - estimated		
from USDA Survey		
Human	87.50	Whole, mature, fluid
Skim	90.80	
Lowfat	90.80	1%

<sup>a</sup> Based on the water content in 100 grams, edible portion.  
Source: USDA, 1979-1984.





Table 11-29. Summary of Meat, Poultry, and Dairy Intake Studies

Study	Survey Population Used in Calculating Intake	Types of Data Used	Units	Food Items
<b>KEY STUDIES</b>				
EPA Analysis of 1989-91 CSFII Data	Per capita	1989-91 CSFII data; Based on 3-day average individual intake rates.	g/kg-day; as consumed	Distributions of intake rates for total meats and total dairy; individual food items.
<b>RELEVANT STUDIES</b>				
AIHC, 1994	Adults, Per Capita	USDA NFCS 1977-78 data presented in the 1989 version of the Exposure Factors Handbook that were analyzed by Finley and Paustenbach (1992).	g/day	Distribution for beef consumption presented in @Risk format.
EPA's DRES (White et al., 1983)	Per capita (i.e., consumers and nonconsumers)	1977-78 NFCS 3-day individual intake data	g/kg-day; as consumed	Intake for a wide variety of meats, poultry, and dairy products presented; complex food groups were disaggregated
NLMB, 1993	Adult daily mean intake rates	MRCA's Menu Census	g/day; as consumed	Intake rates for various meats by region and gender.
Pao et al., 1982	Consumers only serving size data provided	1977-78 NFCS 3-day individual intake data	g; as consumed	Distributions of serving sizes for meats, poultry, and dairy products.
USDA, 1980; 1992; 1996a; 1996b	Per capita and consumer only grouped by age and sex	1977-78 and 1987-88 NFCS, and 1994 and 1995 CSFII 1-day individual intake data	g/day; as consumed	Total meat, poultry and fish, total poultry, total milk, cheese and eggs.
USDA, 1993	Per capita consumption based on "food disappearance"	Based on food supply and utilization data which were provided by National Agricultural Statistics Service (NASS), Customs Service reports, and trade associations.	g/day; as consumed	Intake rates of meats, poultry, and dairy products; intake rates of individual food items.
U.S. EPA/ORP, 1984a; 1984b	Per capita	1977-78 NFCS Individual intake data	g/day; as consumed	Mean intake rates for total meats, total dairy products, and individual food items.
U.S. EPA/OST, 1989	Estimated lifetime dietary intake	Based on FDA Total Diet Study Food List which used 1977-78 NFCS data, and NHANES II data	g/day; dry weight	Various food groups; complex foods disaggregated



Table 11-30. Summary of Recommended Values for Per Capita Intake of Meat and Dairy Products and Serving Size			
Mean	95th Percentile	Multiple Percentiles	Study
<u>Total Meat Intake</u>			
2.1 g/kg-day	5.1 g/kg-day	see Table 11-1	EPA Analysis of CSFII 1989-91 Data
<u>Total Dairy Intake</u>			
8.0 g/kg-day	29.7 g/kg-day	see Table 11-2	EPA Analysis of CSFII 1989-91 Data
<u>Individual Meat and Dairy Products</u>			
see Tables 11-3 to 11-7	see Tables 11-3 to 11-7	see Tables 11-3 to 11-7	EPA Analysis of CSFII 1989-91 Data



Table 11-31. Confidence in Meats and Dairy Products Intake Recommendations

Considerations	Rationale	Rating
<b>Study Elements</b>		
• Level of peer review	USDA CSFII survey receives high level of peer review. EPA analysis of these data has been peer reviewed outside the Agency.	High
• Accessibility	CSFII data are publicly available.	High
• Reproducibility	Enough information is included to reproduce results.	High
• Focus on factor of interest	Analysis is specifically designed to address food intake.	High
• Data pertinent to U.S.	Data focuses on the U.S. population.	High
• Primary data	This is new analysis of primary data.	High
• Currency	Were the most current data publicly available at the time the analysis was conducted for this Handbook.	High
• Adequacy of data collection period	Survey is designed to collect short-term data.	Medium confidence for average values; Low confidence for long term percentile distribution
• Validity of approach	Survey methodology was adequate.	High
• Study size	Study size was very large and therefore adequate.	High
• Representativeness of the population	The population studied was the U.S. population.	High
• Characterization of variability	Survey was not designed to capture long term day-to-day variability. Short term distributions are provided for various age groups, regions, etc.	Medium
• Lack of bias in study design (high rating is desirable)	Response rate was adequate.	Medium
• Measurement error	No measurements were taken. The study relied on survey data.	N/A
<b>Other Elements</b>		
• Number of studies	1 CSFII was the most recent data set publicly available at the time the analysis was conducted for this Handbook. Therefore, it was the only study classified as key study.	Low
• Agreement between researchers	Although the CSFII was the only study classified as key study, the results are in good agreement with earlier data.	High
<b>Overall Rating</b>	The survey is representative of U.S. population. Although there was only one study considered key, these data are the most recent and are in agreement with earlier data. The approach used to analyze the data was adequate. However, due to the limitations of the survey design, estimation of long-term percentile values (especially the upper percentiles) is uncertain.	High confidence in the average; Low confidence in the long-term upper percentiles



**APPENDIX 11A**

**SAMPLE CALCULATION OF MEAN DAILY FAT INTAKE BASED ON CDC (1994) DATA**



Sample Calculation of Mean Daily Fat Intake Based on CDC (1994) Data

CDC (1994) provided data on the mean daily total food energy intake (TFEI) and the mean percentages of TFEI from total dietary fat grouped by age and gender. The overall mean daily TFEI was 2,095 kcal for the total population and 34 percent (or 82 g) of their TFEI was from total dietary fat (CDC, 1994). Based on this information, the amount of fat per kcal was calculated as shown in the following example.

$$0.34 \times 2,095 \frac{\text{kcal}}{\text{day}} \times X \frac{\text{g-fat}}{\text{day}} = 82 \frac{\text{g-fat}}{\text{day}}$$

$$\therefore X = 0.12 \frac{\text{g-fat}}{\text{kcal}}$$

where 0.34 is the fraction of fat intake, 2,095 is the total food intake, and X is the conversion factor from kcal/day to g-fat/day.

Using the conversion factor shown above (i.e., 0.12 g-fat/kcal) and the information on the mean daily TFEI and percentage of TFEI for the various age/gender groups, the daily fat intake was calculated for these groups. An example of obtaining the grams of fat from the daily TFEI (1,591 kcal/day) for children ages 3-5 and their percent TFEI from total dietary fat (33 percent) is as follows:

$$1,591 \frac{\text{kcal}}{\text{day}} \times 0.33 \times 0.12 \frac{\text{g-fat}}{\text{kcal}} = 63 \frac{\text{g-fat}}{\text{day}}$$

# TABLE OF CONTENTS

	<u>Page No.</u>
12. INTAKE OF GRAIN PRODUCTS .....	1
12.1. INTAKE STUDIES .....	1
12.1.1. U.S. Department of Agriculture Nationwide Food Consumption Survey and Continuing Survey of Food Intake by Individuals . . . .	1
12.1.2. Key Grain Products Intake Studies Based on the CSFII .....	2
12.1.3. Relevant Grain Products Intake Studies .....	2
12.1.4. Key Grain Products Serving Size Study Based on the USDA NFCS .....	4
12.2. CONVERSION BETWEEN AS CONSUMED AND DRY WEIGHT INTAKE RATES .....	4
<b>12.4. REFERENCES FOR CHAPTER 12</b> .....	5
APPENDIX 12A .....	12A-1

## LIST OF TABLES

Table 12-1. Per Capita Intake of Total Grains Including Mixtures (g/kg-day as consumed) <sup>a</sup>	12-6
Table 12-2. Per Capita Intake of Breads (g/kg-day as consumed) <sup>a</sup>	12-7
Table 12-3. Per Capita Intake of Sweets (g/kg-day as consumed) <sup>a</sup>	12-8
Table 12-4. Per Capita Intake of Snacks Containing Grain (g/kg-day as consumed) <sup>a</sup>	12-9
Table 12-5. Per Capita Intake of Breakfast Foods (g/kg-day as consumed) <sup>a</sup>	12-10
Table 12-6. Per Capita Intake of Pasta (g/kg-day as consumed)	12-11
Table 12-7. Per Capita Intake of Cooked Cereals (g/kg-day as consumed)	12-12
Table 12-8. Per Capita Intake of Rice (g/kg-day as consumed)	12-13
Table 12-9. Per Capita Intake of Ready-to-Eat Cereals (g/kg-day as consumed) <sup>a</sup>	12-14
Table 12-10. Per Capita Intake of Baby Cereals (g/kg-day as consumed)	12-15
Table 12-12. Mean Per Capita Intake Rates for Grains Based on All Sex/Age/Demographic Subgroups	12-16
Table 12-13 - Mean Grain Intake Per Individual in a Day by Sex and Age (g/day as consumed) <sup>a</sup> for 1977-1978	12-17
Table 12-14 - Mean Grain Intakes Per Individual in a Day by Sex and Age (g/day as consumed) <sup>a</sup> for 1987-1988	12-17
Table 12-15 - Mean Grain Intakes Per Individual in a Day by Sex and Age (g/day as consumed) <sup>a</sup> for 1994 and 1995	12-18
Table 12-16. Mean and Standard Error for the Daily Per Capita Intake of Grains, by Age (g/day as consumed)	12-18
Table 12-17. Mean and Standard Error for the Daily Intake of Grains, by Region (g/day as consumed)	12-19
Table 12-18. Consumption of Grains (g dry weight/day) for Different Age Groups and Estimated Lifetime Average Daily Food Intakes for a U.S. Citizen(averaged across sex) Cal	12-19
Table 12-19. Per Capita Consumption of Flour and Cereal Products in 1991 <sup>a</sup>	12-20
Table 12-20. Quantity (as consumed) of Grain Products Consumed Per Eating Occasion and the Percentage of Individuals Using These Foods in 3 Days	12-20
Table 12-22. Summary of Grain Intake Studies	12-22
Table 12-23. Summary of Recommended Values for Per Capita Intake of Grain Products	12-22
Table 12-24. Confidence in Grain Products Intake Recommendation	12-23
Table 12A-1. Food Codes and Definitions Used in the Analysis of the 1989-91 USDA CSFII Grains Data	12-3



**12. INTAKE OF GRAIN PRODUCTS**

Consumption of grain products is a potential pathway of exposure to toxic chemicals. These food sources can become contaminated by absorption or deposition of ambient air pollutants onto the plants, contact with chemicals dissolved in rainfall or irrigation waters, or absorption of chemicals through plant roots from soil and ground water. The addition of pesticides, soil additives, and fertilizers may also result in contamination of grain products.

The U.S. Department of Agriculture's (USDA) Nationwide Food Consumption Survey (NFCS) and Continuing Survey of Food Intakes by Individuals (CSFII) are the primary sources of information on intake rates of grain products in the United States. Data from the NFCS have been used in various studies to generate consumer-only and per capita intake rates for both individual grain products and total grains. CSFII 1989-91 survey data have been analyzed by EPA to generate per capita intake rates for various food items and food groups. As described in Volume II, Chapter 9 - Intake of Fruits and Vegetables, consumer-only intake is defined as the quantity of grain products consumed by individuals who ate these food items during the survey period. Per capita intake rates are generated by averaging consumer-only intakes over the entire population of users and non-users. In general, per capita intake rates are appropriate for use in exposure assessments for which average dose estimates for the general population are of interest because they represent both individuals who ate the foods during the survey period and individuals who may eat the food items at some time, but did not consume them during the survey period.

This Chapter provides intake data for individual grain products and total grains. Recommendations are based on average and upper-percentile intake among the general population of the U.S. Available data have been classified as being either a key or a relevant study based on the considerations discussed in Volume I, Section 1.3.1 of the Introduction. Recommendations are based on data from the 1989-91 CSFII survey, which was considered the only key intake study for grain products. Other relevant studies are also presented to provide the reader with added perspective on this topic. It should be noted that most of the key and relevant studies presented in this Chapter are based on data from USDA's NFCS and CSFII. The USDA NFCS and CSFII are described below.

**12.1. INTAKE STUDIES****12.1.1. U.S. Department of Agriculture Nationwide Food Consumption Survey and Continuing Survey of Food Intake by Individuals**

The NFCS and CSFII are the basis of much of the data on grain intake presented in this section. Data from the 1977-78 NFCS are presented because the data have been published by USDA in various reports and reanalyzed by various EPA offices according to the food items/groups commonly used to assess exposure. Published one-day data from the 1987-88 NFCS and 1994 and 1994 CSFII are also presented. Recently, EPA conducted an analysis of USDA's 1989-91 CSFII. These data were the most recent food survey data available to the public at the time that EPA analyzed the data for this Handbook. The results of EPA's analyses are presented here. Detailed descriptions of the NFCS and CSFII data are presented in Volume II, Chapter 9 - Intake of Fruits and Vegetables.

Individual average daily intake rates calculated from NFCS and CSFII data are based on averages of reported individual intakes over one day or three consecutive days. Such short term data are suitable for estimating average daily intake rates representative of both short-term and long-term consumption. However, the distribution of average daily intake rates generated using short term data (e.g., 3-day) do not necessarily reflect the long-term distribution of average daily intake rates. The distributions generated from short term and long term data will differ to the extent that each individual's intake varies from day to day; the distributions will be similar to the extent that individuals' intakes are constant from day to day.

Day-to-day variation in intake among individuals will be great for food item/groups that are highly seasonal and for items/groups that are eaten year around, but that are not typically eaten every day. For these foods, the intake distribution generated from short term data will not be a good reflection of the long term distribution. On the other hand, for broad categories of foods (e.g., total grains) which are eaten on a daily basis throughout the year with minimal seasonality, the short term distribution may be a reasonable approximation of the true long term distribution, although it will show somewhat more variability. In this Chapter, distributions are shown for the various grain categories. Because of the increased variability of the short-term distribution, the short-term upper percentiles shown will overestimate somewhat the corresponding percentiles of the long-term distribution.



**12.1.2. Key Grain Products Intake Studies Based on the CSFII**

*U.S. EPA Analysis of 1989-91 USDA CSFII Data* - EPA conducted an analysis of USDA's 1989-91 CSFII data set. The general methodology used in analyzing the data is presented in Volume II, Chapter 9 - Intake of Fruits and Vegetables of this Handbook. Intake rates were generated for the following grain products: total grains, breads, sweets, snacks, breakfast foods, pasta, cooked cereals, rice, ready-to-eat cereals, and baby cereals. Appendix 12A provides the food codes and descriptions used in this grain analysis. The data for total grains have been corrected to account for mixtures as described in Volume II, Chapter 9 - Intake of Fruits and Vegetables and Appendix 9A using an assumed grain content of 31 percent for grain mixtures and 13 percent for meat mixtures. Per capita intake rates for total grains are presented in Tables 12-1. Table 12-2 through 12-10 present per capita intake data for individual grain products. The results are presented in units of g/kg-day. Thus, use of these data in calculating potential dose does not require the body weight factor to be included in the denominator of the average daily dose (ADD) equation. It should be noted that converting these intake rates into units of g/day by multiplying by a single average body weight is inappropriate, because individual intake rates were indexed to the reported body weights of the survey respondents. However, if there is a need to compare the intake data presented here to intake data in units of g/day, a body weight less than 70 kg (i.e., approximately 60 kg; calculated based on the number of respondents in each age category and the average body weights for these age groups, as presented in Volume I, Chapter 7) should be used because the total survey population included children as well as adults.

The advantages of using the 1989-91 CSFII data set are that the data are expected to be representative of the U.S. population and that it includes data on a wide variety of food types. The data set was the most recent of a series of publicly available USDA data sets (i.e., NFCS 1977-78; NFCS 1987-88; CSFII 1989-91) at the time the analysis was conducted for this Handbook, and should reflect recent eating patterns in the United States. The data set includes three years of intake data combined. However, the 1989-91 CSFII data are based on a three day survey period. Short-term dietary data may not accurately reflect long-term eating patterns. This is particularly true for the tails of the distribution of food intake. In addition, the adjustment for including mixtures adds uncertainty to the intake rate distributions. The calculation for including mixtures

assumes that intake of any mixture includes grains in the proportions specified in Appendix Table 9A-1. This assumption yields valid estimates of per capita consumption, but results in overestimates of the proportion of the population consuming total grains; thus, the quantities reported in Table 12-1 should be interpreted as upper bounds on the proportion of the population consuming grain products.

The data presented in this handbook for the USDA 1989-91 CSFII is not the most up-to-date information on food intake. USDA has recently made available the data from its 1994 and 1995 CSFII. Over 5,500 people nationwide participated in both of these surveys providing recalled food intake information for 2 separate days. Although the 2-day data analysis has not been conducted, USDA published the results for the respondents' intakes on the first day surveyed (USDA, 1996a; 1996b). USDA 1996 survey data will be made available later in 1997. As soon as 1996 data are available, EPA will take steps to get the 3-year data (1994, 1995, and 1996) analyzed and the food ingestion factors updated. Meanwhile, Table 12-11 presents a comparison of the mean daily intakes per individual in a day for grains from the USDA survey data from years 1977-78, 1987-88, 1989-91, 1994, and 1995. This table shows that food consumption patterns have changed for grains and grain mixtures when comparing 1977 and 1995 data. When comparing data from 1977 and 1995, consumption of grains mixtures and grain increased by 106 percent and 41 percent, respectively. However, consumption of grains has remained fairly constant when comparing values from 1989-91 with the most recent data from 1994 and 1995. Grain mixtures and grains increase 20 percent and 11 percent, respectively from 1989 to 1995. The 1989-91 CSFII data are probably adequate for assessing ingestion exposure for current populations, but these data should be used with caution.

**12.1.3. Relevant Grain Products Intake Studies**

*The U.S. EPA's Dietary Risk Evaluation System (DRES) - USEPA, Office of Pesticide Programs (OPP)* - EPA OPP's DRES contains per capita intake rate data for various grain products for 22 subgroups (age, regional, and seasonal) of the population. As described in Volume II, Chapter 9 - Intake of Fruits and Vegetables, intake data in DRES were generated by determining the composition of 1977/78 NFCS food items and disaggregating complex food dishes into their component raw agricultural commodities (RACs) (White et al., 1983). The DRES per capita, as consumed intake rates for all age/sex/demographic groups



combined are presented in Table 12-12. These data are based on both consumers and non-consumers of these food items. Data for specific subgroups of the population are not presented in this section, but are available through OPP via direct request. The data in Table 12-12 may be useful for estimating the risks of exposure associated with the consumption of the various grain products presented. It should be noted that these data are indexed to the reported body weights of the survey respondents and are expressed in units of grams of food consumed per kg body weight per day. Consequently, use of these data in calculating potential dose does not require the body weight factor in the denominator of the average daily dose (ADD) equation. It should also be noted that conversion of these intake rates into units of g/day by multiplying by a single average body weight is not appropriate because the DRES data base did not rely on a single body weight for all individuals. Instead, DRES used the body weights reported by each individual surveyed to estimate consumption in units of g/kg-day.

The advantages of using these data are that complex food dishes have been disaggregated to provide intake rates for a variety of grains. These data are also based on the individual body weights of the respondents. Therefore, the use of these data in calculating exposure to toxic chemicals may provide more representative estimates of potential dose per unit body weight. However, because the data are based on NFCS short-term dietary recall, the same limitations discussed previously for other NFCS data sets also apply here. In addition, consumption patterns may have changed since the data were collected in 1977-78. OPP is in the process of translating consumption information from the USDA CSFII 1989-91 survey to be used in DRES.

*Food and Nutrient Intakes of Individuals in One Day in the U.S., USDA (1980, 1992; 1996a; 1996b)* - USDA calculated mean per capita intake rates for total and individual grain products using NFCS data from 1977-78 and 1987-88 (USDA 1980; 1992) and CSFII data from 1994 and 1995 (USDA, 1996a; 1996b). The mean per capita intake rates for grain products are presented in Tables 12-13 and 12-14 for the two NFCS survey years, respectively. Table 12-15 presents similar data from the 1994 and 1995 CSFII for grain products.

The advantages of using these data are that they provide mean intake estimates for various grain products. The consumption estimates are based on short-term (i.e., 1-day) dietary data which may not reflect long-term consumption.

*U.S. EPA - Office of Radiation Programs* - The U.S. EPA Office of Radiation Programs (ORP) has also used the

USDA 1977-78 NFCS to estimate daily food intake. ORP uses food consumption data to assess human intake of radionuclides in foods (U.S. EPA, 1984a; 1984b). The 1977-78 NFCS data have been reorganized by ORP, and food items have been classified according to the characteristics of radionuclide transport. The mean dietary per capita intake of grain products, grouped by age, for the U.S. population are presented in Table 12-16. The mean daily intake rates of grain products for the U.S. population grouped by regions are presented in Table 12-17. Because this study was based on the USDA NFCS, the limitations and advantages associated with the USDA-NFCS data also apply to this data set. Also, consumption patterns may have changed since the data were collected in 1977-78.

*U.S. EPA - Office of Science and Technology* - The U.S. EPA Office of Science and Technology (OST) within the Office of Water (formerly the Office of Water Regulations and Standards) used data from the FDA revision of the Total Diet Study Food Lists and Diets (Pennington, 1983) to calculate food intake rates. OST uses these consumption data in its risk assessment model for land application of municipal sludge. The FDA data used are based on the combined results of the USDA 1977-78 NFCS and the second National Health and Nutrition Examination Survey (NHANES II), 1976-80 (U.S. EPA, 1989). Because food items are listed as prepared complex foods in the FDA Total Diet Study, each item was broken down into its component parts so that the amount of raw commodities consumed could be determined. Table 12-18 presents intake rates for grain products for various age groups. Estimated lifetime ingestion rates derived by U.S. EPA (1989) are also presented in Table 12-18. Note that these are per capita intake rates tabulated as grams dry weight/day. Therefore, these rates differ from those in the previous tables because USDA (1980; 1992) and U.S. EPA (1984a, 1984b) report intake rates on an as consumed basis.

The EPA-OST analysis provides intake rates for additional food categories and estimates of lifetime average daily intake on a per capita basis. In contrast to the other analyses of USDA NFCS data, this study reports the data in terms of dry weight intake rates. Thus, conversion is not required when contaminants are provided on a dry weight basis. These data, however, may not reflect current consumption patterns because they are based on 1977-78 data.

*USDA (1993) - Food Consumption, Prices, and Expenditures, 1970-92* - The USDA's Economic Research Service (ERS) calculates the amount of food available for



human consumption in the United States annually. Supply and utilization balance sheets are generated. These are based on the flow of food items from production to end uses. Total available supply is estimated as the sum of production (i.e., some products are measured at the farm level or during processing), starting inventories, and imports (USDA, 1993). The availability of food for human use commonly termed as "food disappearance" is determined by subtracting exported foods, products used in industries, farm inputs (seed and feed) and end-of-the year inventories from the total available supply (USDA, 1993). USDA (1993) calculates the per capita food consumption by dividing the total food disappearance by the total U.S. population.

USDA (1993) estimated per capita consumption data for grain products from 1970-1992 (1992 data are preliminary). In this section, the 1991 values, which are the most recent final data, are presented. Table 12-19 presents per capita consumption in 1991 for grains.

One of the limitations of this study is that disappearance data do not account for losses from the food supply from waste, spoilage, or foods fed to pets. Thus, intake rates based on these data may overestimate daily consumption because they are based on the total quantity of marketable commodity utilized. Therefore, these data may be useful for estimating bounding exposure estimates. It should also be noted that per capita estimates based on food disappearance are not a direct measure of actual consumption or quantity ingested, instead the data are used as indicators of changes in usage over time (USDA, 1993). An advantage of this study is that it provides per capita consumption rates for grains which are representative of long-term intake because disappearance data are generated annually. Daily per capita intake rates are generated by dividing annual consumption by 365 days/year.

**12.1.4. Key Grain Products Serving Size Study Based on the USDA NFCS**

*Pao et al. (1982) - Foods Commonly Eaten by Individuals* - Using data gathered in the 1977-78 USDA NFCS, Pao et al. (1982) calculated percentiles for the quantities of grain products consumed per eating occasion by members of the U.S. population. The data were collected during NFCS home interviews of 37,874 respondents, who were asked to recall food intake for the day preceding the interview, and record food intake the day of the interview and the day after the interview. Quantities consumed per eating occasion, are presented in Table 12-20.

The advantages of using these data are that they were derived from the USDA NFCS and are representative of the U.S. population. This data set provides distributions of serving sizes for a number of commonly eaten grain products, but the list of foods is limited and does not account for grain products included in complex food dishes. Also, these data are based on short-term dietary recall and may not accurately reflect long-term consumption patterns. Although these data are based on the 1977-78 NFCS, serving size data have been collected, but not published, for the more recent USDA surveys.

**12.2. CONVERSION BETWEEN AS CONSUMED AND DRY WEIGHT INTAKE RATES**

As noted previously, intake rates may be reported in terms of units as consumed or units of dry weight. It is essential that exposure assessors be aware of this difference so that they may ensure consistency between the units used for intake rates and those used for concentration data (i.e., if the unit of food consumption is grams dry weight/day, then the unit for the amount of pollutant in the food should be grams dry weight). If necessary, as consumed intake rates may be converted to dry weight intake rates using the moisture content percentages of grain products presented in Table 12-21 and the following equation:

$$IR_{dw} = IR_{ac} * [(100-W)/100] \quad \text{(Eqn. 12-1)}$$

Dry weight" intake rates may be converted to "as consumed" rates by using:

$$IR_{ac} = IR_{dw}/[(100-W)/100] \quad \text{(Eqn. 12-2)}$$

where:

- $IR_{dw}$  = dry weight intake rate;
- $IR_{ac}$  = as consumed intake rate; and
- $W$  = percent water content.

**12.3. RECOMMENDATIONS**

The 1989-91 CSFII data described in this section were used in selecting recommended grain, product intake rates for the general population and various subgroups of the United States population. The general design of both key and relevant studies are summarized in Table 12-22. The recommended values for intake of grain products are



summarized in Table 12-23 and the confidence ratings for the recommended values for grain intake rates are presented in Table 12-24. Per capita intake rates for specific grain items, on a g/kg-day basis, may be obtained from Tables 12-2 through 12-10. Percentiles of the intake rate distribution in the general population for total grains, are presented in Table 12-1. From these tables, the mean and 95th percentile intake rates for grains are 4.1 g/kg-day and 10.8 g/kg-day, respectively. It is important to note that the data presented in Tables 12-1 through 12-10 are based on data collected over a 3-day period and may not necessarily reflect the long-term distribution of average daily intake rates. However, for the broad categories of foods (i.e., total grains, breads), because they may be eaten on a daily basis throughout the year with minimal seasonality, the short-term distribution may be a reasonable approximation of the long-term distribution, although it will display somewhat increased variability. This implies that the upper percentiles shown will tend to overestimate the corresponding percentiles of the true long-term distribution. It should be noted that because these recommendations are based on 1989-91 CSFII data, they may not reflect the most recent changes in consumption patterns. However, as indicated in Table 12-11, intake has remained fairly constant between 1989-19 and 1995. Thus, the 1989-91 CSFII data are believed to be appropriate for assessing ingestion exposure for current populations.

#### **12.4. REFERENCES FOR CHAPTER 12**

- Pao, E.M.; Fleming, K.H.; Guenther, P.M.; Mickle, S.J. (1982) Foods commonly eaten by individuals: amount per day and per eating occasion. U.S. Department of Agriculture. Home Economics Report No. 44.
- Pennington, J.A.T. (1983) Revision of the total diet study food list and diets. J. Am. Diet. Assoc. 82:166-173.
- USDA. (1980) Food and nutrient intakes of individuals in one day in the United States, Spring 1977. U.S. Department of Agriculture. Nationwide Food Consumption Survey 1977-1978. Preliminary Report No. 2.
- USDA. (1992) Food and nutrient intakes by individuals in the United States, 1 day, 1987-88. U.S. Department of Agriculture, Human Nutrition Information Service. Nationwide Food Consumption Survey 1987-88, NFCS Rpt. No. 87-I-1.
- USDA. (1993) Food consumption prices and expenditures (1970-1992) U.S. Department of Agriculture, Economic Research Service. Statistical Bulletin, No. 867.
- USDA. (1996a) Data tables: results from USDA's 1994 Continuing Survey of Food Intakes by Individuals and 1994 Diet and Health Knowledge Survey. U.S. Department of Agriculture, Agricultural Research Service, Riverdale, MD.
- USDA. (1996b) Data tables: results from USDA's 1995 Continuing Survey of Food Intakes by Individuals and 1995 Diet and Health Knowledge Survey. U.S. Department of Agriculture, Agricultural Research Service, Riverdale, MD.
- U.S. EPA. (1984a) An estimation of the daily average food intake by age and sex for use in assessing the radionuclide intake of individuals in the general population. EPA-520/1-84-021.
- U.S. EPA. (1984b) An estimation of the daily food intake based on data from the 1977-1978 USDA Nationwide Food Consumption Survey. Washington, DC: Office of Radiation Programs. EPA-520/1-84-015.
- U.S. EPA. (1989) Development of risk assessment methodologies for land application and distribution and marketing of municipal sludge. Washington, DC: Office of Science and Technology. EPA 600/89/001.
- White, S.B.; Peterson, B.; Clayton, C.A.; Duncan, D.P. (1983) Interim Report Number 1: The construction of a raw agricultural commodity consumption data base. Prepared by Research Triangle Institute for EPA Office of Pesticide Programs.

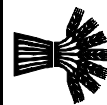

Table 12-1. Per Capita Intake of Total Grains Including Mixtures (g/kg-day as consumed)<sup>a</sup>

Population Group	Percent Consuming	MEAN	SE	P1	P5	P10	P25	P50	P75	P90	P95	P99	P100
<b>Total</b>	97.5%	4.061	0.033	0	0.74	1.16	1.90	3.06	4.96	8.04	10.77	18.53	42.98
<b>Age (years)</b>													
< 01	80.4%	7.049	0.361	0	0	0	1.46	6.05	10.18	16.75	19.50	27.61	37.41
1-2	95.8%	10.567	0.285	0	2.86	4.34	6.55	9.59	14.06	18.92	21.57	28.22	42.98
3-5	97.5%	9.492	0.201	0	3.13	4.35	6.09	8.91	11.88	15.13	19.14	23.87	33.08
6-11	97.7%	6.422	0.117	0	2.14	2.88	4.07	5.70	7.82	10.26	12.85	21.40	31.93
12-19	98.2%	3.764	0.065	0	1.15	1.52	2.16	3.31	4.81	6.46	8.03	10.92	19.30
20-39	98.4%	3.095	0.035	0	0.70	1.08	1.75	2.73	4.00	5.47	6.55	9.57	25.71
40-69	98.3%	2.792	0.031	0	0.69	0.98	1.59	2.47	3.54	4.96	6.09	8.40	20.34
70 +	98.7%	3.263	0.066	0.38	0.89	1.24	1.86	2.72	4.04	5.81	7.63	10.47	21.45
<b>Season</b>													
Fall	97.9%	4.282	0.066	0	0.84	1.24	2.07	3.19	5.19	8.54	11.88	19.10	37.77
Spring	97.0%	3.983	0.071	0	0.70	1.10	1.79	2.95	4.73	7.78	10.52	23.87	31.93
Summer	97.5%	3.948	0.062	0	0.74	1.13	1.82	2.99	4.96	7.98	10.16	15.34	30.13
Winter	97.6%	4.031	0.063	0	0.70	1.17	1.95	3.17	4.99	8.00	10.48	16.86	42.98
<b>Urbanization</b>													
Central City	97.6%	4.159	0.061	0	0.75	1.13	1.91	3.06	5.07	8.71	11.61	17.69	37.77
Nonmetropolitan	96.9%	4.013	0.067	0	0.60	1.11	1.85	3.12	4.93	7.81	10.08	21.05	31.93
Suburban	97.8%	4.02	0.049	0	0.80	1.18	1.90	3.04	4.91	7.79	10.63	18.53	42.98
<b>Race</b>													
Asian	94.0%	6.479	0.402	0	0	1.46	3.02	5.44	9.07	14.13	14.63	20.65	23.78
Black	96.9%	4.372	0.103	0	0.55	0.94	1.81	3.05	5.69	9.47	12.47	18.96	40.07
Native American	87.7%	3.98	0.276	0	0	0.61	1.63	3.67	5.81	6.90	9.00	20.43	21.84
Other/NA	97.1%	4.561	0.208	0	0	1.21	2.26	3.56	5.36	8.87	11.72	22.07	30.51
White	97.9%	3.962	0.035	0	0.79	1.18	1.90	3.03	4.80	7.79	10.20	18.07	42.98
<b>Region</b>													
Midwest	97.3%	4.016	0.07	0	0.79	1.17	1.90	2.92	4.69	7.80	11.04	20.36	31.93
Northeast	97.6%	4.255	0.079	0	0.78	1.26	2.02	3.19	5.37	8.44	11.61	17.73	42.98
South	97.9%	3.943	0.052	0	0.71	1.10	1.83	3.06	4.89	8.13	10.20	16.42	40.07
West	97.2%	4.116	0.072	0	0.69	1.13	1.92	3.13	5.03	7.98	10.90	19.50	25.89

<sup>a</sup> Includes breads; sweets such as cakes, pie, and pastries; snack and breakfast foods made with grains; pasta; cooked ready-to-eat, and baby cereals, rice and grain mixtures.  
 Note: SE = Standard error  
 P = Percentile of the distribution  
 Source: Based on EPA's analysis of the 1989-91 CSFII.



Table 12-2. Per Capita Intake of Breads (g/kg-day as consumed)<sup>a</sup>

Population Group	Percent Consuming	MEAN	SE	P1	P5	P10	P25	P50	P75	P90	P95	P99	P100
<b>Total</b>	91.6%	1.133	0.010	0	0	0.19	0.48	0.90	1.50	2.31	3.04	4.67	12.99
<b>Age (years)</b>													
< 01	50.9%	1.072	0.102	0	0	0	0	0.34	1.65	3.29	4.06	6.09	12.99
1-2	88.9%	2.611	0.089	0	0	0.44	1.17	2.39	3.86	4.68	5.42	8.23	10.29
3-5	91.9%	2.217	0.063	0	0	0.44	1.19	2.03	3.04	4.01	5.14	6.95	12.35
6-11	93.4%	1.668	0.037	0	0	0.40	0.88	1.44	2.18	3.16	3.98	5.95	9.17
12-19	91.8%	1.068	0.025	0	0	0.21	0.45	0.91	1.46	2.15	2.78	3.43	7.44
20-39	92.9%	0.936	0.012	0	0	0.18	0.43	0.81	1.27	1.81	2.27	3.41	7.04
40-69	93.7%	0.915	0.011	0	0	0.20	0.46	0.81	1.25	1.77	2.08	2.83	11.16
70 +	95.1%	0.976	0.021	0	0.15	0.29	0.56	0.87	1.31	1.76	2.15	2.76	11.81
<b>Season</b>													
Fall	91.3%	1.181	0.020	0	0	0.17	0.50	0.94	1.57	2.45	3.16	5.27	11.81
Spring	91.4%	1.095	0.018	0	0	0.18	0.48	0.89	1.45	2.18	2.91	4.54	12.35
Summer	92.4%	1.126	0.018	0	0	0.21	0.48	0.90	1.51	2.24	2.98	4.43	9.17
Winter	91.2%	1.129	0.019	0	0	0.19	0.47	0.89	1.50	2.37	3.07	4.66	12.99
<b>Urbanization</b>													
Central City	91.2%	1.127	0.017	0	0	0.18	0.49	0.91	1.50	2.33	2.98	4.50	11.81
Nonmetropolitan	91.7%	1.184	0.020	0	0	0.18	0.48	0.93	1.54	2.51	3.24	4.97	12.99
Suburban	91.8%	1.113	0.014	0	0	0.19	0.49	0.89	1.49	2.20	2.89	4.68	12.35
<b>Race</b>													
Asian	78.5%	0.981	0.078	0	0	0	0.34	0.86	1.51	2.57	2.61	3.34	3.34
Black	88.8%	1.159	0.030	0	0	0.11	0.37	0.84	1.55	2.59	3.29	5.58	8.94
Native American	81.3%	1.336	0.133	0	0	0.13	0.41	0.72	1.80	2.91	4.13	9.09	11.71
Other/NA	89.1%	1.333	0.067	0	0	0	0.62	1.11	1.70	2.66	3.79	6.16	9.98
White	92.5%	1.121	0.010	0	0	0.20	0.51	0.91	1.48	2.23	2.95	4.51	12.99
<b>Region</b>													
Midwest	91.2%	1.109	0.018	0	0	0.20	0.50	0.90	1.49	2.22	2.91	4.43	7.97
Northeast	91.1%	1.104	0.021	0	0	0.18	0.51	0.90	1.48	2.26	2.83	4.50	9.98
South	91.8%	1.155	0.017	0	0	0.18	0.46	0.92	1.54	2.41	3.13	4.89	12.99
West	92.1%	1.153	0.022	0	0	0.19	0.49	0.91	1.48	2.35	3.12	5.14	12.35

<sup>a</sup> Includes breads, rolls, muffins, bagels, biscuits, cornbread, and tortillas.  
 Note: SE = Standard error  
 P = Percentile of the distribution  
 Source: Based on EPA's analysis of the 1989-91 CSFII.



Table 12-3. Per Capita Intake of Sweets (g/kg-day as consumed)<sup>a</sup>

Population Group	Percent Consuming	MEAN	SE	P1	P5	P10	P25	P50	P75	P90	P95	P99	P100
<b>Total</b>	50.2%	0.508	0.011	0	0	0	0	0.13	0.71	1.50	2.12	3.96	13.39
<b>Age (years)</b>													
< 01	28.1%	0.447	0.096	0	0	0	0	0	0.41	1.42	2.26	5.51	9.35
1-2	49.6%	1.144	0.111	0	0	0	0	0.43	1.75	3.32	4.87	6.51	13.39
3-5	59.2%	1.139	0.079	0	0	0	0	0.56	1.82	3.01	4.33	6.78	9.25
6-11	63.7%	0.881	0.046	0	0	0	0	0.43	1.29	2.33	3.28	5.39	12.97
12-19	54.0%	0.511	0.030	0	0	0	0	0.22	0.75	1.47	1.99	3.25	9.65
20-39	45.0%	0.383	0.015	0	0	0	0	0	0.59	1.24	1.66	2.48	7.45
40-69	49.1%	0.381	0.015	0	0	0	0	0.08	0.55	1.13	1.58	2.70	5.70
70 +	56.3%	0.444	0.029	0	0	0	0	0.16	0.63	1.29	1.64	2.73	6.94
<b>Season</b>													
Fall	52.9%	0.533	0.022	0	0	0	0	0.14	0.76	1.55	2.21	3.82	13.39
Spring	48.3%	0.466	0.021	0	0	0	0	0.10	0.65	1.36	1.82	3.58	9.35
Summer	48.5%	0.527	0.025	0	0	0	0	0.06	0.70		2.35	4.54	8.73
Winter	51.2%	0.508	0.022	0	0	0	0	0.19	0.71	1.50	2.00	4.00	10.84
<b>Urbanization</b>													
Central City	45.3%	0.495	0.021	0	0	0	0	0.11	0.65	1.55	2.12	4.24	9.94
Nonmetropolitan	52.3%	0.593	0.025	0	0	0	0	0.25	0.82	1.58	2.34	4.52	13.39
Suburban	52.4%	0.477	0.015	0	0	0	0	0.10	0.69	1.42	2.00	3.55	9.65
<b>Race</b>													
Asian	37.6%	0.515	0.101	0	0	0	0	0.05	0.78	1.82	2.22	2.52	4.06
Black	39.3%	0.387	0.030	0	0	0	0	0	0.46	1.20	1.71	3.51	9.67
Native American	33.9%	0.325	0.075	0	0	0	0	0	0.33	1.47	1.48	2.44	3.78
Other/NA	32.3%	0.283	0.088	0	0	0	0	0	0.21	0.64	1.45	3.04	9.94
White	53.2%	0.537	0.012	0	0	0	0	0.17	0.77	1.55	2.17	4.09	13.39
<b>Region</b>													
Midwest	53.0%	0.573	0.024	0	0	0	0	0.17	0.79	1.65	2.41	4.00	12.97
Northeast	55.9%	0.587	0.027	0	0	0	0	0.22	0.83	1.63	2.21	4.60	13.39
South	47.5%	0.471	0.018	0	0	0	0	0.09	0.65	1.39	1.98	3.89	10.84
West	46.7%	0.416	0.022	0	0	0	0	0	0.55	1.25	1.91	3.33	9.65

<sup>a</sup> Includes cakes, cookies, pies, pastries, doughnuts, breakfast bars, and coffee cakes.  
 NOTE: SE = Standard error  
 P = Percentile of the distribution  
 Source: Based on EPA's analysis of the 1989-91 CSFII.





Table 12-4. Per Capita Intake of Snacks Containing Grain (g/kg-day as consumed)<sup>a</sup>

Population Group	Percent Consuming	MEAN	SE	P1	P5	P10	P25	P50	P75	P90	P95	P99	P100
<b>Total</b>	40.3%	0.160	0.005	0	0	0	0	0	0.18	0.47	0.78	1.74	6.73
<b>Age (years)</b>													
< 01	31.4%	0.321	0.064	0	0	0	0	0	0.35	1.24	1.82	4.66	5.73
1-2	46.7%	0.398	0.040	0	0	0	0	0.10	0.65	1.30	1.61	2.03	6.73
3-5	48.9%	0.393	0.034	0	0	0	0	0.12	0.58	1.22	1.65	2.20	4.76
6-11	43.1%	0.269	0.023	0	0	0	0	0	0.32	0.86	1.24	2.43	4.00
12-19	40.2%	0.170	0.016	0	0	0	0	0	0.21	0.50	0.74	1.94	3.51
20-39	38.2%	0.123	0.007	0	0	0	0	0	0.15	0.41	0.60	1.21	4.60
40-69	40.3%	0.104	0.006	0	0	0	0	0	0.14	0.33	0.46	1.06	2.85
70 +	40.9%	0.074	0.007	0	0	0	0	0	0.10	0.20	0.36	0.70	1.47
<b>Season</b>													
Fall	41.6%	0.180	0.012	0	0	0	0	0	0.18	0.50	0.87	1.99	6.73
Spring	38.3%	0.136	0.009	0	0	0	0	0	0.15	0.43	0.67	1.29	3.43
Summer	37.5%	0.165	0.010	0	0	0	0	0	0.18	0.52	0.86	1.72	5.73
Winter	43.9%	0.160	0.010	0	0	0	0	0	0.19	0.44	0.76	1.77	4.60
<b>Urbanization</b>													
Central City	36.5%	0.158	0.010	0	0	0	0	0	0.16	0.46	0.81	1.81	3.70
Nonmetropolitan	39.8%	0.144	0.009	0	0	0	0	0	0.17	0.44	0.66	1.32	4.76
Suburban	43.3%	0.169	0.008	0	0	0	0	0	0.18	0.50	0.80	1.75	6.73
<b>Race</b>													
Asian	22.1%	0.077	0.035	0	0	0	0	0	0.04	0.27	0.37	1.09	1.34
Black	25.9%	0.107	0.014	0	0	0	0	0	0.07	0.33	0.59	1.19	4.76
Native American	30.4%	0.142	0.050	0	0	0	0	0	0.16	0.32	0.44	1.29	4.60
Other/NA	28.3%	0.139	0.026	0	0	0	0	0	0.17	0.43	0.69	1.27	1.91
White	43.7%	0.170	0.006	0	0	0	0	0	0.19	0.49	0.81	1.80	6.73
<b>Region</b>													
Midwest	45.2%	0.202	0.012	0	0	0	0	0	0.23	0.57	0.99	1.95	6.73
Northeast	35.8%	0.113	0.010	0	0	0	0	0	0.10	0.35	0.61	1.28	5.73
South	39.8%	0.162	0.008	0	0	0	0	0	0.19	0.46	0.80	1.63	4.76
West	39.4%	0.155	0.011	0	0	0	0	0	0.16	0.46	0.76	1.81	4.60

<sup>a</sup> Includes grain snacks such as crackers, salty snacks, popcorn, and pretzels.

NOTE: SE = Standard error

P = Percentile of the distribution

Source: Based on EPA's analysis of the 1989-91 CSFII.



Table 12-5. Per Capita Intake of Breakfast Foods (g/kg-day as consumed)<sup>a</sup>

Population Group	Percent Consuming	MEAN	SE	P1	P5	P10	P25	P50	P75	P90	P95	P99	P100
<b>Total</b>	15.0%	0.144	0.012	0	0	0	0	0	0	0.46	0.95	2.46	13.61
<b>Age (years)</b>													
< 01	13.2%	0.255	0.108	0	0	0	0	0	0	0.57	2.08	3.82	5.72
1-2	20.9%	0.418	0.103	0	0	0	0	0	0.37	1.54	2.50	4.62	9.92
3-5	24.5%	0.446	0.078	0	0	0	0	0	0.56	1.63	2.33	3.92	11.90
6-11	25.0%	0.307	0.045	0	0	0	0	0	0.31	1.12	1.69	2.82	13.61
12-19	18.4%	0.193	0.038	0	0	0	0	0	0	0.65	1.16	3.06	5.38
20-39	13.2%	0.086	0.014	0	0	0	0	0	0	0.31	0.61	1.53	4.41
40-69	10.8%	0.063	0.011	0	0	0	0	0	0	0.23	0.51	0.95	2.98
70 +	12.5%	0.096	0.025	0	0	0	0	0	0	0.41	0.65	1.37	3.09
<b>Season</b>													
Fall	15.1%	0.146	0.021	0	0	0	0	0	0	0.49	0.93	2.61	6.83
Spring	13.2%	0.120	0.023	0	0	0	0	0	0	0.34	0.71	2.32	6.23
Summer	14.8%	0.145	0.022	0	0	0	0	0	0	0.53	0.98	2.02	7.41
Winter	17.0%	0.168	0.027	0	0	0	0	0	0	0.55	1.04	2.94	13.61
<b>Urbanization</b>													
Central City	15.1%	0.142	0.021	0	0	0	0	0	0	0.42	0.93	2.61	7.17
Nonmetropolitan	13.3%	0.120	0.020	0	0	0	0	0	0	0.39	0.85	1.97	7.41
Suburban	15.9%	0.157	0.019	0	0	0	0	0	0	0.52	1.06	2.45	13.61
<b>Race</b>													
Asian	10.1%	0.076	0.060	0	0	0	0	0	0	0.24	0.61	1.04	1.46
Black	11.9%	0.114	0.032	0	0	0	0	0	0	0.20	0.78	2.46	7.41
Native American	18.7%	0.156	0.073	0	0	0	0	0	0.21	0.53	0.61	1.23	6.83
Other/NA	13.7%	0.079	0.037	0	0	0	0	0	0	0.40	0.43	1.40	2.33
White	15.6%	0.152	0.013	0	0	0	0	0	0	0.51	0.97	2.56	13.61
<b>Region</b>													
Midwest	14.7%	0.121	0.020	0	0	0	0	0	0	0.38	0.75	2.06	7.41
Northeast	15.2%	0.158	0.034	0	0	0	0	0	0	0.43	1.02	2.61	13.61
South	12.3%	0.130	0.019	0	0	0	0	0	0	0.42	0.92	2.33	4.59
West	19.7%	0.184	0.024	0	0	0	0	0	0	0.67	1.14	2.58	6.96

<sup>a</sup> Includes breakfast foods made with grains such as pancakes, waffles, and french toast.

NOTE: SE = Standard error

P = Percentile of the distribution

Source: Based on EPA's analysis of the 1989-91



Table 12-6. Per Capita Intake of Pasta (g/kg-day as consumed)

Population Group	Percent Consuming	MEAN	SE	P1	P5	P10	P25	P50	P75	P90	P95	P99	P100
<b>Total</b>	13.6%	0.233	0.018	0	0	0	0	0	0	0.90	1.60	3.67	24.01
<b>Age (years)</b>													
< 01	7.3%	0.172	0.124	0	0	0	0	0	0	0.00	1.18	3.79	6.43
1-2	14.0%	0.569	0.212	0	0	0	0	0	0	1.72	5.14	6.68	24.01
3-5	15.3%	0.543	0.142	0	0	0	0	0	0	2.19	3.37	6.51	7.72
6-11	15.9%	0.338	0.063	0	0	0	0	0	0	1.47	2.35	3.43	7.72
12-19	14.3%	0.194	0.047	0	0	0	0	0	0	0.77	1.47	3.36	7.24
20-39	15.2%	0.232	0.027	0	0	0	0	0	0	0.96	1.57	2.83	7.17
40-69	12.5%	0.172	0.028	0	0	0	0	0	0	0.62	1.32	2.67	10.20
70 +	9.9%	0.083	0.029	0	0	0	0	0	0	0.03	0.76	1.57	2.62
<b>Season</b>													
Fall	14.0%	0.239	0.038	0	0	0	0	0	0	0.94	1.72	3.77	24.01
Spring	13.9%	0.250	0.036	0	0	0	0	0	0	0.96	1.65	3.28	9.47
Summer	13.6%	0.251	0.039	0	0	0	0	0	0	0.97	1.72	3.80	11.12
Winter	12.9%	0.193	0.034	0	0	0	0	0	0	0.68	1.33	3.22	8.73
<b>Urbanization</b>													
Central City	12.9%	0.197	0.034	0	0	0	0	0	0	0.65	1.34	3.43	24.01
Nonmetropolitan	11.4%	0.171	0.032	0	0	0	0	0	0	0.63	1.33	2.48	11.12
Suburban	15.4%	0.286	0.028	0	0	0	0	0	0	1.12	1.96	3.92	10.20
<b>Race</b>													
Asian	18.8%	0.918	0.355	0	0	0	0	0	0.70	3.80	5.78	6.51	10.20
Black	6.6%	0.138	0.054	0	0	0	0	0	0	0.00	1.08	3.27	5.14
Other/NA	8.6%	0.115	0.083	0	0	0	0	0	0	0.00	1.16	2.43	3.86
White	15.1%	0.243	0.019	0	0	0	0	0	0	0.94	1.65	3.46	24.01
<b>Region</b>													
Midwest	12.8%	0.182	0.030	0	0	0	0	0	0	0.74	1.24	2.76	9.46
Northeast	21.9%	0.367	0.043	0	0	0	0	0	0	1.47	2.14	4.62	24.01
South	9.2%	0.179	0.035	0	0	0	0	0	0	0.45	1.32	3.63	11.12
West	14.7%	0.252	0.038	0	0	0	0	0	0	1.07	1.63	3.25	10.20
NOTE: SE = Standard error P = Percentile of the distribution													
Source: Based on EPA's analysis of the 1989-91 CSFII.													

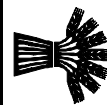

Table 12-7. Per Capita Intake of Cooked Cereals (g/kg-day as consumed)

Population Group	Percent Consuming	MEAN	SE	P1	P5	P10	P25	P50	P75	P90	P95	P99	P100
<b>Total</b>	17.1%	0.441	0.035	0	0	0	0	0	0	1.37	2.79	8.18	28.63
<b>Age (years)</b>													
< 01	17.9%	1.350	0.417	0	0	0	0	0	0	7.17	8.60	20.47	24.16
1-2	23.6%	1.783	0.365	0	0	0	0	0	1.39	7.00	9.41	14.84	28.63
3-5	21.2%	1.335	0.258	0	0	0	0	0	0	4.99	8.18	12.51	18.66
6-11	18.1%	0.669	0.142	0	0	0	0	0	0	2.32	4.49	10.76	16.42
12-19	11.0%	0.156	0.065	0	0	0	0	0	0	0	1.26	3.34	11.85
20-39	10.5%	0.166	0.040	0	0	0	0	0	0	0	1.33	3.33	13.18
40-69	18.3%	0.307	0.036	0	0	0	0	0	0	1.30	2.20	3.97	18.23
70 +	35.3%	0.782	0.079	0	0	0	0	0	1.08	2.71	3.80	7.37	10.03
<b>Season</b>													
Fall	21.2%	0.573	0.066	0	0	0	0	0	0	1.90	3.71	9.15	28.63
Spring	15.8%	0.439	0.082	0	0	0	0	0	0	1.07	2.29	12.28	21.84
Summer	12.1%	0.288	0.069	0	0	0	0	0	0	0.55	1.98	5.37	24.16
Winter	19.1%	0.463	0.062	0	0	0	0	0	0	1.57	3.12	7.00	24.34
<b>Urbanization</b>													
Central City	19.3%	0.523	0.068	0	0	0	0	0	0	1.52	3.27	10.03	28.63
Nonmetropolitan	20.0%	0.483	0.066	0	0	0	0	0	0	1.52	2.72	7.41	20.94
Suburban	13.9%	0.369	0.052	0	0	0	0	0	0	1.09	2.35	7.37	24.34
<b>Race</b>													
Black	30.3%	0.838	0.092	0	0	0	0	0	0.65	2.95	4.45	10.03	28.63
NativeAmerican	17.5%	0.372	0.196	0	0	0	0	0	0	2.15	2.99	4.80	5.73
Other/NA	12.6%	0.510	0.293	0	0	0	0	0	0	1.12	3.18	7.60	20.94
White	15.1%	0.382	0.039	0	0	0	0	0	0	1.11	2.32	7.38	24.34
<b>Region</b>													
Midwest	15.5%	0.507	0.083	0	0	0	0	0	0	1.39	3.01	10.32	21.85
Northeast	13.2%	0.395	0.093	0	0	0	0	0	0	1.00	2.73	7.02	24.34
South	21.4%	0.396	0.044	0	0	0	0	0	0	1.40	2.48	5.53	28.63
West	15.2%	0.483	0.086	0	0	0	0	0	0	1.45	3.12	9.41	16.47
NOTE:		SE = Standard error P = Percentile of the distribution											
Source:		Based on EPA's analysis of the 1989-91 CSFII.											



Table 12-8. Per Capita Intake of Rice (g/kg-day as consumed)

Population Group	Percent Consuming	MEAN	SE	P1	P5	P10	P25	P50	P75	P90	P95	P99	P100
<b>Total</b>	20.0%	0.357	0.022	0	0	0	0	0	0	1.26	2.15	4.85	17.59
<b>Age (years)</b>													
< 01	11.8%	0.405	0.209	0	0	0	0	0	0	1.40	2.89	7.87	15.54
1-2	24.4%	0.811	0.192	0	0	0	0	0	0.36	3.36	4.52	9.81	17.59
3-5	25.0%	0.736	0.127	0	0	0	0	0	0.76	2.83	3.77	6.70	14.35
6-11	20.8%	0.504	0.090	0	0	0	0	0	0	1.71	3.33	7.86	13.39
12-19	20.1%	0.316	0.052	0	0	0	0	0	0	1.26	1.91	3.74	9.60
20-39	21.3%	0.341	0.037	0	0	0	0	0	0	1.20	1.90	5.02	12.69
40-69	19.6%	0.259	0.028	0	0	0	0	0	0	0.94	1.64	3.35	12.00
70 +	14.9%	0.229	0.050	0	0	0	0	0	0	0.81	1.73	3.12	7.97
<b>Season</b>													
Fall	18.8%	0.307	0.041	0	0	0	0	0	0	0.94	2.13	4.92	16.74
Spring	21.5%	0.395	0.046	0	0	0	0	0	0	1.34	2.47	5.05	15.54
Summer	19.3%	0.376	0.045	0	0	0	0	0	0	1.31	2.05	5.02	12.55
Winter	20.5%	0.350	0.041	0	0	0	0	0	0	1.37	2.09	4.17	17.59
<b>Urbanization</b>													
Central City	26.1%	0.449	0.039	0	0	0	0	0	0.18	1.51	2.51	5.54	16.74
Nonmetropolitan	15.9%	0.311	0.046	0	0	0	0	0	0	1.04	1.90	5.02	12.91
Suburban	18.3%	0.320	0.031	0	0	0	0	0	0	1.16	2.01	4.30	17.59
<b>Race</b>													
Asian	72.5%	2.353	0.316	0	0	0	0	1.32	2.83	6.20	10.39	15.06	17.59
Black	37.2%	0.603	0.048	0	0	0	0	0	0.87	2.08	2.93	5.16	12.91
Other/NA	37.7%	0.655	0.116	0	0	0	0	0	0.80	2.15	3.78	6.06	10.71
White	15.9%	0.281	0.023	0	0	0	0	0	0	0.94	1.79	4.30	15.54
<b>Region</b>													
Midwest	12.3%	0.207	0.046	0	0	0	0	0	0	0.62	1.25	3.59	13.39
Northeast	20.3%	0.378	0.050	0	0	0	0	0	0	1.45	2.15	4.65	16.74
South	25.2%	0.455	0.036	0	0	0	0	0	0	1.62	2.71	5.21	15.54
West	20.4%	0.349	0.045	0	0	0	0	0	0	1.25	1.84	4.52	17.59
NOTE:		SE = Standard error P = Percentile of the distribution											
Source:		Based on EPA's analysis of the 1989-91 CSFII.											

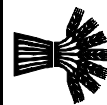

Table 12-9. Per Capita Intake of Ready-to-Eat Cereals (g/kg-day as consumed<sup>a</sup>)

Population Group	Percent Consuming	MEAN	SE	P1	P5	P10	P25	P50	P75	P90	P95	P99	P100
<b>Total</b>	45.6%	0.306	0.007	0	0	0	0	0	0.42	0.92	1.37	2.61	7.12
<b>Age (years)</b>													
< 01	38.9%	0.431	0.059	0	0	0	0	0	0.64	1.55	1.94	3.40	4.40
1-2	70.7%	0.954	0.057	0	0	0	0	0.74	1.46	2.28	2.89	4.77	6.47
3-5	77.3%	1.026	0.044	0	0	0	0.31	0.83	1.48	2.35	2.99	3.67	5.65
6-11	69.0%	0.631	0.025	0	0	0	0	0.45	0.92	1.55	1.97	3.12	7.12
12-19	50.8%	0.317	0.019	0	0	0	0	0.16	0.48	0.90	1.14	2.61	4.06
20-39	34.3%	0.174	0.010	0	0	0	0	0	0.23	0.61	0.88	1.51	5.11
40-69	37.1%	0.166	0.008	0	0	0	0	0	0.25	0.55	0.74	1.32	3.36
70 +	52.4%	0.222	0.013	0	0	0	0	0.08	0.36	0.64	0.83	1.55	2.71
<b>Season</b>													
Fall	45.2%	0.293	0.014	0	0	0	0	0	0.40	0.94	1.42	2.38	7.12
Spring	45.6%	0.320	0.015	0	0	0	0	0	0.44	0.95	1.42	2.69	5.88
Summer	46.6%	0.330	0.016	0	0	0	0	0	0.45	0.99	1.42	2.82	5.65
Winter	44.8%	0.280	0.014	0	0	0	0	0	0.39	0.81	1.22	2.61	6.47
<b>Urbanization</b>													
Central City	46.6%	0.319	0.014	0	0	0	0	0	0.43	0.94	1.42	2.86	5.11
Nonmetropolitan	43.6%	0.283	0.014	0	0	0	0	0	0.38	0.85	1.33	2.52	7.12
Suburban	46.0%	0.307	0.011	0	0	0	0	0	0.44	0.93	1.36	2.46	6.47
<b>Race</b>													
Asian	33.6%	0.218	0.065	0	0	0	0	0	0.24	0.81	1.28	2.79	3.12
Black	41.1%	0.269	0.018	0	0	0	0	0	0.40	0.82	1.16	2.50	4.46
Native American	38.6%	0.298	0.078	0	0	0	0	0	0.32	0.76	1.23	3.26	4.40
Other/NA	42.9%	0.340	0.050	0	0	0	0	0	0.43	1.12	1.59	2.69	4.18
White	46.7%	0.311	0.008	0	0	0	0	0	0.42	0.94	1.39	2.61	7.12
<b>Region</b>													
Midwest	48.7%	0.328	0.015	0	0	0	0	0	0.47	0.98	1.37	2.55	7.12
Northeast	46.9%	0.286	0.017	0	0	0	0	0	0.38	0.89	1.33	2.70	6.47
South	41.4%	0.284	0.012	0	0	0	0	0	0.40	0.81	1.26	2.34	5.88
West	47.7%	0.336	0.016	0	0	0	0	0	0.46	1.05	1.47	2.84	5.11
<sup>a</sup> Includes dry ready-to-eat corn, rice, wheat, and bran cereals in the form of flakes, puffs, etc. NOTE: SE = Standard error P = Percentile of the distribution Source: Based on EPA's analysis of the 1989-91 CSFII.													



Table 12-10. Per Capita Intake of Baby Cereals (g/kg-day as consumed)

Population Group	Percent Consuming	MEAN	SE	P1	P5	P10	P25	P50	P75	P90	P95	P99	P100
<b>Total</b>	1.1%	0.037	0.051	0	0	0	0	0	0	0	0	0	22.57
<b>Age (years)<sup>a</sup></b>													
< 01	28.5%	1.205	0.280	0	0	0	0	0	0.64	4.59	6.94	16.99	22.57
<b>Season</b>													
Fall	1.1%	0.036	0.075	0	0	0	0	0	0	0	0	0.69	14.94
Spring	1.1%	0.059	0.138	0	0	0	0	0	0	0	0	0.13	16.99
Summer	1.0%	0.017	0.068	0	0	0	0	0	0	0	0	0	12.03
Winter	1.0%	0.035	0.107	0	0	0	0	0	0	0	0	0	22.57
<b>Urbanization</b>													
Central City	1.3%	0.048	0.088	0	0	0	0	0	0	0	0	1.05	22.57
Nonmetropolitan	0.9%	0.011	0.040	0	0	0	0	0	0	0	0	0	9.41
Suburban	1.0%	0.042	0.093	0	0	0	0	0	0	0	0	0	16.99
<b>Race</b>													
Asian	0.7%	0.017	0.137	0	0	0	0	0	0	0	0	1.10	1.10
Black	2.1%	0.092	0.151	0	0	0	0	0	0	0	0	4.59	22.57
Native American	1.2%	0.010	0.088	0	0	0	0	0	0	0	0	0	1.63
Other/NA	3.1%	0.050	0.133	0	0	0	0	0	0	0	0	2.94	13.42
White	0.8%	0.029	0.059	0	0	0	0	0	0	0	0	0	16.99
<b>Region</b>													
Midwest	1.1%	0.020	0.050	0	0	0	0	0	0	0	0	0	12.50
Northeast	1.0%	0.084	0.208	0	0	0	0	0	0	0	0	1.25	16.99
South	1.0%	0.016	0.060	0	0	0	0	0	0	0	0	0	22.57
West	1.1%	0.046	0.101	0	0	0	0	0	0	0	0	1.18	10.18

<sup>a</sup> Data presented only for children less than 1 year of age. Available data for other age groups was based on a very small number of observations  
 NOTE: SE = Standard error  
 P = Percentile of the distribution  
 Source: Based on EPA's analysis of the 1989-91 CSFII.



Table 12-11. Mean Daily Intakes of Grains Per Individual in a Day for USDA 1977-78, 87-88, 89-91, 94, and 95 Surveys					
Food Product	77-78 Data (g/day)	87-88 Data (g/day)	89-91 Data (g/day)	94 Data (g/day)	95 Data (g/day)
Grains	215	237	273	300	303
Grains Mixtures	52	72	89	112	107

Source: USDA, 1980; 1992; 1996a; 1996b.

Table 12-12. Mean Per Capita Intake Rates for Grains Based on All Sex/Age/Demographic Subgroups		
Raw Agricultural Commodity <sup>a</sup>	Average Consumption (Grams/kg Body Weight-Day)	Standard Error
Oats	0.0825748	0.0026061
Rice-rough	0.0030600	0.0004343
Rice-milled	0.1552627	0.0083546
Rye-rough	0.0000010	--
Rye-germ	0.0002735	0.0000483
Rye-flour	0.0040285	0.0002922
Wheat-rough	0.1406118	0.0050410
Wheat-germ	0.0008051	0.0000789
Wheat-bran	0.0121575	0.0004864
Wheat-flour	1.2572489	0.0127412
Millet	0.0000216	0.0000104

<sup>a</sup> Consumed in any raw or prepared form.  
Source: DRES data base (based on 1977-78 NFCS).





Chapter 12 - Intake of Grain Products

Table 12-13. Mean Grain Intake Per Individual in a Day by Sex and Age (g/day as consumed)<sup>a</sup> for 1977-1978

Group Age (years)	Total Grains	Breads, Rolls, Biscuits	Other Baked Goods	Cereals, Pasta	Mixtures, Mainly Grain <sup>b</sup>
<b>Males and Females</b>					
Under 1	42	4	5	30	3
1-2	158	27	24	44	63
3-5	181	46	37	54	45
6-8	206	53	56	60	38
<b>Males</b>					
9-11	238	67	56	51	64
12-14	288	76	80	57	74
15-18	303	91	77	53	82
19-22	253	84	53	64	52
23-34	256	82	60	40	74
35-50	234	82	58	44	50
51-64	229	78	57	48	46
65-74	235	71	60	69	35
75 and Over	196	70	50	58	19
<b>Females</b>					
9-11	214	58	59	44	53
12-14	235	57	61	45	72
15-18	196	57	43	41	55
19-22	161	44	36	33	48
23-34	163	49	38	32	44
35-50	161	49	37	32	43
51-64	155	52	40	36	27
65-74	175	57	42	47	29
75 and Over	178	54	44	58	22
<b>Males and Females</b>					
All Ages	204	62	49	44	49

<sup>a</sup> Based on USDA Nationwide Food Consumption Survey 1977-78 data for one day.  
<sup>b</sup> Includes mixtures containing grain as the main ingredient.  
 Source: USDA, 1980.

Table 12-14. Mean Grain Intakes Per Individual in a Day by Sex and Age (g/day as consumed)<sup>a</sup> for 1987-1988

Group Age (years)	Total Grains	Yeast Breads and Rolls	Quick Breads, Pancakes, French Toast	Cakes, Cookies, Pastries, Pies	Crackers, Popcorn, Pretzels, Corn Chips	Cereals and Pastas	Mixtures, Mostly Grain <sup>b</sup>
<b>Males and Females 5 and Under</b>							
	167	30	8	22	4	52	51
<b>Males</b>							
6-11	268	51	16	37	8	74	83
12-19	304	65	28	45	10	58	83
20 and Over	272	65	20	37	8		
<b>Females</b>							
6-11	231	43	19	30	6	66	68
12-19	239	45	13	29	7	52	91
20 and Over	208	45	14	28	6	53	62
All Individuals	237	52	16	32	7	57	72

<sup>a</sup> Based on USDA Nationwide Food Consumption Survey 1987-88 data for one day.  
<sup>b</sup> Includes mixtures containing grain as the main ingredient.  
 Source: USDA, 1992.



Table 12-15. Mean Grain Intakes Per Individual in a Day by Sex and Age (g/day as consumed)<sup>a</sup> for 1994 and 1995

Group Age (years)	Total Grains		Yeast Breads and Rolls		Quick Breads, Pancakes, French Toast		Cakes, Cookies, Pastries, Pies		Crackers, Popcorn, Pretzels, Corn Chips		Cereals and Pastas		Mixtures, Mostly Grain <sup>b</sup>	
	1994	1995	1994	1995	1994	1995	1994	1995	1994	1995	1994	1995	1994	1995
Males and Females 5 and Under	213	210	26	28	11	11	22	23	8	7	58	57	89	84
Males														
6-11	285	341	51	45	15	21	42	46	12	18	66	97	101	115
12-19	417	364	53	54	30	21	54	43	17	22	82	84	180	138
20 and Over	357	365	64	61	22	24	43	46	13	15	86	91	128	128
Females														
6-11	260	286	43	46	16	21	37	51	11	14	57	54	94	100
12-19	317	296	40	37	16	14	39	35	17	16	63	52	142	143
20 and Over	254	257	44	45	16	15	33	34	9	10	59	69	92	83
All Individuals	300	303	50	49	18	19	38	39	12	13	70	76	112	107

<sup>a</sup> Based on USDA CSFII 1994 and 1995 data for one day.  
<sup>b</sup> Includes mixtures containing grain as the main ingredient.  
Source: USDA, 1996a; 1996b.

Table 12-16. Mean and Standard Error for the Daily Per Capita Intake of Grains, by Age (g/day as consumed)

Age (years)	Breads	Cereals	Other Grains
All ages	147.3 $\pm$ 1.4	29.9 $\pm$ 1.3	22.9 $\pm$ 1.7
Under 1	16.2 $\pm$ 9.2	37.9 $\pm$ 8.2	1.8 $\pm$ 10.9
1 to 4	104.6 $\pm$ 4.5	38.4 $\pm$ 4.0	14.8 $\pm$ 5.4
5 to 9	154.3 $\pm$ 3.8	39.5 $\pm$ 3.4	22.7 $\pm$ 4.5
10 to 14	186.2 $\pm$ 3.6	36.4 $\pm$ 3.2	25.6 $\pm$ 4.2
15 to 19	188.5 $\pm$ 3.7	28.8 $\pm$ 3.3	27.8 $\pm$ 4.4
20 to 24	166.5 $\pm$ 4.9	20.2 $\pm$ 4.3	25.0 $\pm$ 5.8
25 to 29	170.0 $\pm$ 5.0	18.2 $\pm$ 4.4	26.6 $\pm$ 5.9
30 to 39	156.8 $\pm$ 3.9	18.8 $\pm$ 3.5	26.4 $\pm$ 4.6
40 to 59	144.4 $\pm$ 3.1	24.7 $\pm$ 2.7	23.3 $\pm$ 3.6
60 and over	122.1 $\pm$ 3.4	42.5 $\pm$ 3.0	19.3 $\pm$ 4.0

Source: U.S. EPA, 1984a (based on 1977-78 NFCS).



Table 12-17. Mean and Standard Error for the Daily Intake of Grains, by Region (g/day as consumed)

Region	Total Grains	Breads	Cereals	Other Grains
All Regions	200.0±3.0	147.3±1.4	29.9±1.3	22.9±1.7
Northeast	203.5±5.8	153.1±2.8	24.6±2.5	25.9±3.3
North Central	192.8±5.6	150.9±2.7	28.7±2.4	13.3±3.2
South	202.2±4.7	143.9±2.3	34.6±2.0	23.7±2.7
West	202.6±6.9	139.5±3.3	30.9±3.0	32.1±4.0

NOTE: Northeast = Maine, New Hampshire, Vermont, Massachusetts, Connecticut, Rhode Island, New York, New Jersey, and Pennsylvania.  
 North Central = Ohio, Illinois, Indiana, Wisconsin, Michigan, Minnesota, Iowa, Missouri, North Dakota, South Dakota, Nebraska, and Kansas.  
 South = Maryland, Delaware, District of Columbia, Virginia, West Virginia, North Carolina, South Carolina, Georgia, Florida, Kentucky, Tennessee, Alabama, Mississippi, Arkansas, Louisiana, Texas, and Oklahoma.  
 West = Montana, Idaho, Wyoming, Utah, Colorado, New Mexico, Arizona, Nevada, Washington, Oregon, and California.  
 Source: U.S. EPA, 1984b (based on 1977-78 NFCS).

Table 12-18. Consumption of Grains (g dry weight/day) for Different Age Groups and Estimated Lifetime Average Daily Food Intakes for a U.S. Citizen (averaged across sex) Calculated from the FDA Diet Data

	Age (years)						Estimated lifetime
	(0-1)	(1-5)	(6-13)	(14-19)	(20-44)	(45-70)	
Wheat	27.60	42.23	60.80	79.36	65.86	55.13	60.30
Corn	4.00	15.35	19.28	23.21	12.83	14.82	12.01
Rice	2.22	4.58	5.24	5.89	5.78	4.21	5.03
Oats	3.73	2.65	2.27	1.89	1.32	2.00	1.85
Other Grain	0.01	0.08	0.41	0.73	13.45	4.41	6.49
Total Grain	37.56	64.82	87.58	110.34	90.59	76.12	84.19

<sup>a</sup> The estimated lifetime dietary intakes were estimated by:

$$\text{Estimated lifetime} = \frac{\text{IR}(0-1) + 5\text{yrs} * \text{IR} (1-5) + 8\text{yrs} * \text{IR} (6-13) + 6\text{yrs} * \text{IR} (14-19) + 25\text{yrs} * \text{IR} (20-44) + 25\text{yrs} * \text{IR} (45-70)}{70\text{ years}}$$

where IR = the intake rate for a specific age group.  
 Source: U.S. EPA, 1989 (based on 1977-78 NFCS and NHANES II data).



Table 12-19. Per Capita Consumption of Flour and Cereal Products in 1991<sup>a</sup>

Food Item	Per Capita Consumption (g/day) <sup>a</sup>
Total Wheat Flour <sup>b</sup>	169.8
Rye Flour	0.7
Rice <sup>c</sup>	20.9
Total Corn Products <sup>d</sup>	27.2
Oat Products <sup>e</sup>	10.7
Barley Products <sup>f</sup>	1.1
Total Flour and Cereal Products <sup>g</sup>	230.6

<sup>a</sup> Original data were presented in lbs/yr; data were converted to g/day by multiplying by a factor of 454 g/lb and dividing by 365 days/yr. Consumption of most items at the processing level. Excludes quantities used in alcoholic beverages and fuel.  
<sup>b</sup> Includes white, whole wheat, and durum flour.  
<sup>c</sup> Milled basis.  
<sup>d</sup> Includes corn flour and meal, hominy and grits, and corn starch.  
<sup>e</sup> Includes rolled oats, ready-to-eat cereals, oat flour, and oat bran.  
<sup>f</sup> Includes barley flour, pearl barley, and malt and malt extract used in food processing.  
<sup>g</sup> Excludes wheat not ground into flour, for example, shredded wheat breakfast cereals.  
Source: USDA, 1993.

Table 12-20. Quantity (as consumed) of Grain Products Consumed Per Eating Occasion and the Percentage of Individuals Using These Foods in Three Days

Food category	% Indiv. using food in 3 days	Quantity consumed per eating occasion (g)		Consumers-only Quantity consumed per eating occasion at specified percentiles (g)						
		Average	Standard Deviation	5	25	50	75	90	95	99
Yeast Breads	93.7	46	26	21	25	44	50	75	100	140
Pancakes	8.3	113	85	27	54	81	146	219	282	438
Waffles	2.9	87	74	20	40	78	100	158	200	400
Tortillas	2.9	69	39	28	30	60	90	120	140	210
Cakes and Cupcakes	25.5	79	59	23	41	63	99	144	184	284
Cookies	30.8	32	30	7	14	26	40	60	84	144
Pies	11.9	129	60	57	97	120	150	195	236	360
Doughnuts	9.9	64	40	26	42	43	84	106	126	208
Crackers	26.2	22	21	6	12	15	24	42	57	113
Popcorn	5.6	19	22	5	9	15	18	36	45	108
Pretzels	2.2	29	28	3	12	21	36	57	85	160
Corn-based Salty Snacks	5.9	33	30	9	18	21	40	60	80	156
Pasta	11.4	153	108	35	70	140	210	280	320	560
Rice	18.5	147	91	41	88	165	125	263	350	438
Cooked Cereals	12.4	203	110	31	123	240	245	360	480	490
Ready-to-Eat Cereals	43.4	36	25	8	22	29	45	60	84	120

Source: Pao et al., 1982 (based on 1977-78 NFCS).



Table 12-21. Mean Moisture Content of Selected Grains Expressed as Percentages of Edible Portions

Food	Moisture Content (Percent)		Comments
	Raw	Cooked	
Barley - pearled	10.09	68.80	
Corn - grain - endosperm	10.37		
Corn - grain - bran	3.71		crude
Millet	8.67	71.41	
Oats	8.22		
Rice - rough - white	11.62	68.72	
Rye - rough	10.95		
Rye - flour - medium	9.85		
Sorghum (including milo)	9.20		
Wheat - rough - hard white	9.57		
Wheat - germ	11.12		crude
Wheat - bran	9.89		crude
Wheat - flour - whole grain	10.27		

Source: USDA, 1979-1986.



Table 12-22. Summary of Grain Intake Studies

Study	Survey Population Used in Calculating Intake	Types of Data Used	Units	Food Items
<b>KEY STUDIES</b>				
EPA Analysis of 1989-91 CSFII Data	Per capita	1989-91 CSFII data; Based on 3-day average individual intake rates.	g/kg-day; as consumed	Distributions of intake rates for total grain; individual grain items
<b>RELEVANT STUDIES</b>				
EPA's DRES (White et al., 1983)	Per capita (i.e., consumers and nonconsumers)	1977-78 NFCS 3-day individual intake data	g/kg-day; as consumed	Intake for a wide variety of grain products presented; complex food groups were disaggregated
Pao et al., 1982	Consumers only serving size data provided	1977-78 NFCS 3-day individual intake data	g; as consumed	Distributions of serving sizes for grain products
USDA, 1980; 1992; 1996a; 1996b	Per capita and consumer only grouped by age and sex	1977-78 and 1987-88 NFCS, and 1994 and 1995 CSFII 1-day individual intake data	g/day; as consumed	Total grains and various grain products
USDA, 1993b	Per capita consumption based on "food disappearance"	Based on food supply and utilization data	g/day; as consumed	Intake rates of grain products
U.S. EPA/ORP, 1984a; 1984b	Per capita	1977-78 NFCS Individual intake data	g/day; as consumed	Mean intake rates for total grain products, and individual grain items.
U.S. EPA/OST, 1989	Estimated lifetime dietary intake	Based on FDA Total Diet Study Food List which used 1977-78 NFCS data, and NHANES II data	g/day; dry weight	Various food groups; complex foods disaggregated

Table 12-23. Summary of Recommended Values for Per Capita Intake of Grain Products

Mean	95th Percentile	Multiple Percentiles	Study
Total Grain Intake 4.1 g/kg-day	10.8 g/kg-day	see Table 12-1	EPA Analysis of CSFII 1989-91 Data
Individual Grain Products see Tables 12-2 to 12-10	see Tables 12-2 to 12-10	see Table 12-2 to 12-10	EPA Analysis of CSFII 1989-91 Data



Table 12-24. Confidence in Grain Products Intake Recommendation

Considerations	Rationale	Rating
<b>Study Elements</b>		
<ul style="list-style-type: none"> <li>• Level of peer review</li> </ul>	USDA CSFII survey receives high level of peer review. EPA analysis of these data has been peer reviewed outside the Agency.	High
<ul style="list-style-type: none"> <li>• Accessibility</li> </ul>	CSFII data are publicly available.	High
<ul style="list-style-type: none"> <li>• Reproducibility</li> </ul>	Enough information is included to reproduce results.	High
<ul style="list-style-type: none"> <li>• Focus on factor of interest</li> </ul>	Analysis is specifically designed to address food intake.	High
<ul style="list-style-type: none"> <li>• Data pertinent to U.S.</li> </ul>	Data focuses on the U.S. population.	High
<ul style="list-style-type: none"> <li>• Primary data</li> </ul>	This is new analysis of primary data.	High
<ul style="list-style-type: none"> <li>• Currency</li> </ul>	Were the most current data publicly available at the time the analysis was conducted for this Handbook.	High
<ul style="list-style-type: none"> <li>• Adequacy of data collection period</li> </ul>	Survey is designed to collect short-term data.	Medium confidence for average values; Low confidence for long term percentile distribution
<ul style="list-style-type: none"> <li>• Validity of approach</li> </ul>	Survey methodology was adequate.	High
<ul style="list-style-type: none"> <li>• Study size</li> </ul>	Study size was very large and therefore adequate.	High
<ul style="list-style-type: none"> <li>• Representativeness of the population</li> </ul>	The population studied was the U.S. population.	High
<ul style="list-style-type: none"> <li>• Characterization of variability</li> </ul>	Survey was not designed to capture long term day-to-day variability. Short term distributions are provided for various age groups, regions, etc.	Medium
<ul style="list-style-type: none"> <li>• Lack of bias in study design (high rating is desirable)</li> </ul>	Response rate was adequate.	Medium
<ul style="list-style-type: none"> <li>• Measurement error</li> </ul>	No measurements were taken. The study relied on survey data.	N/A
<b>Other Elements</b>		
<ul style="list-style-type: none"> <li>• Number of studies</li> </ul>	1 CSFII was the most recent data set publicly available at the time the analysis was conducted for this Handbook. Therefore, it was the only study classified as key study.	Low
<ul style="list-style-type: none"> <li>• Agreement between researchers</li> </ul>	Although the CSFII was the only study classified as key study, the results are in good agreement with earlier data.	High
<b>Overall Rating</b>	The survey is representative of U.S. population. Although there was only one study considered key, these data are the most recent and are in agreement with earlier data. The approach used to analyze the data was adequate. However, due to the limitations of the survey design estimation of long-term percentile values (especially the upper percentiles) is uncertain.	High confidence in the average; Low confidence in the long-term upper percentiles



**APPENDIX 12A**

**FOOD CODES AND DEFINITIONS USED IN THE  
ANALYSIS OF THE 1989-91 USDA CSFII GRAINS DATA**





Appendix 12A

Table 12A-1. Food Codes and Definitions Used in the Analysis of the 1989-91 USDA CSFII Grains Data					
Food Product	Food Codes and Descriptions		Food Product	Food Codes and Descriptions	
Total Grains	51- 52- 53- 54- 55- 561- 562- 57-	breads tortillas sweets snacks breakfast foods pasta cooked cereals and rice ready-to-eat and baby cereals Also includes the average portion of grain mixtures (i.e., 31 percent) and the average portion of meat mixtures (i.e., 13 percent) made up by grain.	Pasta	561-	macaroni noodles spaghetti
Breads	51- 52-	breads rolls muffins bagel biscuits corn bread tortillas	Cooked Cereals	56200- 56201- 56202- 56203- 562069- 56207- 56208- 56209-	includes grits,oatmeal, cornmeal mush, millet, etc.
Sweets	53-	cakes cookies pies pastries doughnuts breakfast bars coffee cakes	Rice	56204- 56205- 5620601	includes all varieties of rice
Snacks	54-	crackers salty snacks popcorn pretzels	Ready-to-eat Cereals	570- 571- 572- 573- 574- 575- 576-	includes all varieties of ready-to-eat cereals
Breakfast Foods	55-	pancakes waffles french toast	Baby Cereals	578-	baby cereals
Grain Mixtures	58-	grain mixtures	Meat Mixtures	27- 28-	meat mixtures

## TABLE OF CONTENTS

	<u>Page No.</u>
13. INTAKE RATES FOR VARIOUS HOME PRODUCED FOOD ITEMS .....	1
13.1. BACKGROUND .....	1
13.2. METHODS .....	2
13.3. RESULTS .....	7
13.4. ADVANTAGES AND LIMITATIONS .....	9
<b>13.5. RECOMMENDATIONS</b> .....	<b>10</b>
13.6. REFERENCES FOR CHAPTER 13 .....	10

## LIST OF TABLES

Table 13-1. 1986 Vegetable Gardening by Demographic Factors .....	13-1
Table 13-2. Percentage of Gardening Households Growing Different Vegetables in 1986 .....	13-1
Table 13-3. Sub-category Codes and Definitions .....	13-4
Table 13-4. Weighted and Unweighted Number of Observations (Individuals) for NFCS Data Used in Analysis of Food Intake .....	13-6
Table 13-5. Percent Weight Losses from Preparation of Various Meats .....	13-8
Table 13-6. Percent Weight Losses from Preparation of Various Fruits .....	13-8
Table 13-7. Percent Weight Losses from Preparation of Various Vegetables .....	13-9
Table 13-8. Consumer Only Intake of Homegrown Fruits (g/kg-day) - All Regions Combined .....	13-12
Table 13-9. Consumer Only Intake of Homegrown Fruits (g/kg-day) - Northeast .....	13-13
Table 13-10. Consumer Only Intake of Homegrown Fruits (g/kg-day) - Midwest .....	13-13



Chapter 13 - Intake Rates for Various Home Produced Food Items

13. INTAKE RATES FOR VARIOUS HOME PRODUCED FOOD ITEMS

13.1. BACKGROUND

Ingestion of contaminated foods is a potential pathway of exposure to toxic chemicals. Consumers of home produced food products may be of particular concern because exposure resulting from local site contamination may be higher for this subpopulation. According to a survey by the National Gardening Association (1987), a total of 34 million (or 38 percent) U.S. households participated in vegetable gardening in 1986. Table 13-1 contains demographic data on vegetable gardening in 1986 by region/section, community size, and household size.

Demographic Factor	Percentage of total households that have gardens (%)	Number of households (million)
Total	38	34
<u>Region/section</u>		
East	33	7.3
New England	37	1.9
Mid-Atlantic	32	5.4
Midwest	50	11.0
East Central	50	6.6
West Central	50	4.5
South	33	9.0
Deep South	44	3.1
Rest of South	29	5.9
West	37	6.2
Rocky Mountain	53	2.3
Pacific	32	4.2
<u>Size of community</u>		
City	26	6.2
Suburb	33	10.2
Small town	32	3.4
Rural	61	14.0
<u>Household size</u>		
Single, separated, divorced, widowed	54	8.5
Married, no children	45	11.9
Married, with children	44	13.2

Source: National Gardening Association, 1987.

Table 13-2 contains information on the types of vegetables grown by home gardeners in 1986. Tomatoes, peppers, onions, cucumbers, lettuce, beans, carrots, and corn are among the vegetables grown by the largest percentage of

gardeners. Home produced foods can become contaminated in a variety of ways. Ambient pollutants in the air may be deposited on plants, adsorbed onto or absorbed by the plants, or dissolved in rainfall or

Vegetable	Percent
Artichokes	0.8
Asparagus	8.2
Beans	43.4
Beets	20.6
Broccoli	19.6
Brussel sprouts	5.7
Cabbage	29.6
Carrots	34.9
Cauliflower	14.0
Celery	5.4
Chard	3.5
Corn	34.4
Cucumbers	49.9
Dried peas	2.5
Dry beans	8.9
Eggplant	13.0
Herbs	9.8
Kale	3.1
Kohlrabi	3.0
Leeks	1.2
Lettuce	41.7
Melons	21.9
Okra	13.6
Onions	50.3
Oriental vegetables	2.1
Parsnips	2.2
Peanuts	1.9
Peas	29.0
Peppers	57.7
Potatoes	25.5
Pumpkins	10.2
Radishes	30.7
Rhubarb	12.2
Spinach	10.2
Summer squash	25.7
Sunflowers	8.2
Sweet potatoes	5.7
Tomato	85.4
Turnips	10.7
Winter squash	11.1

Source: National Gardening Association, 1987.

irrigation waters that contact the plants. Pollutants may also be adsorbed onto plants roots from contaminated soil and water. Finally, the addition of pesticides, soil additives, and fertilizers to crops or gardens may result in contamination of food products. Meat and dairy products can become contaminated if animals consume contaminated soil, water, or feed crops. Intake rates for home produced food



*Chapter 13 - Intake Rates for Various Home Produced Food Items*

products are needed to assess exposure to local contaminants present in homegrown or home caught foods. Recently, EPA analyzed data from the U.S. Department of Agriculture's (USDA) Nationwide Food Consumption Survey (NFCS) to generate distributions of intake rates for home produced foods. The methods used and the results of these analyses are presented below.

**13.2. METHODS**

Nationwide Food Consumption Survey (NFCS) data were used to generate intake rates for home produced foods. USDA conducts the NFCS every 10 years to analyze the food consumption behavior and dietary status of Americans (USDA, 1992). The most recent NFCS was conducted in 1987-88. The survey used a statistical sampling technique designed to ensure that all seasons, geographic regions of the 48 conterminous states in the U.S., and socioeconomic and demographic groups were represented (USDA, 1994). There were two components of the NFCS. The household component collected information over a seven-day period on the socioeconomic and demographic characteristics of households, and the types, amount, value, and sources of foods consumed by the household (USDA, 1994). The individual intake component collected information on food intakes of individuals within each household over a three-day period (USDA, 1993). The sample size for the 1987-88 survey was approximately 4,300 households (over 10,000 individuals). This is a decrease over the previous survey conducted in 1977-78 which sampled approximately 15,000 households (over 36,000 individuals) (USDA, 1994). The sample size was lower in the 1987-88 survey as a result of budgetary constraints and low response rate (i.e., 38 percent for the household survey and 31 percent for the individual survey) (USDA, 1993). However, NFCS data from 1987-88 were used to generate homegrown intake rates because they were the most recent data available and were believed to be more reflective of current eating patterns among the U.S. population.

The USDA data were adjusted by applying the sample weights calculated by USDA to the data set prior to analysis. The USDA sample weights were designed to "adjust for survey non-response and other vagaries of the sample selection process" (USDA, 1987-88). Also, the USDA weights are calculated "so that the weighted sample total equals the known population total, in thousands, for several characteristics thought to be correlated with eating behavior" (USDA, 1987-88).

For the purposes of this study, home produced foods were defined as homegrown fruits and vegetables, meat and

dairy products derived from consumer-raised livestock or game meat, and home caught fish. The food items/groups selected for analysis included major food groups (i.e., total fruits, total vegetables, total meats, total dairy, total fish and shellfish), individual food items for which >30 households reported eating the home produced form of the item, fruits and vegetables categorized as exposed, protected, and roots, and various USDA fruit and vegetable subcategories (i.e., dark green vegetables, citrus fruits, etc.). Food items/groups were identified in the NFCS data base according to NFCS-defined food codes. Appendix 13A presents the codes used to determine the various food groups.

Although the individual intake component of the NFCS gives the best measure of the amount of each food item eaten by each individual in the household, it could not be used directly to measure consumption of home produced food because the individual component does not identify the source of the food item (i.e., as home produced or not). Therefore, an analytical method which incorporated data from both the household and individual survey components was developed to estimate individual home produced food intake. The USDA household data were used to determine (1) the amount of each home produced food item used during a week by household members and (2) the number of meals eaten in the household by each household member during a week. Note that the household survey reports the total amount of each food item used in the household (whether by guests or household members); the amount used by household members was derived by multiplying the total amount used in the household by the proportion of all meals served in the household (during the survey week) that were consumed by household members.

The individual survey data were used to generate average sex- and age-specific serving sizes for each food item. The age categories used in the analysis were as follows: 1 to 2 years; 3 to 5 years; 6 to 11 years; 12 to 19 years; 20 to 39 years; 40 to 69 years; and over 70 years (intake rates were not calculated for children under 1; the rationale for this is discussed below). These serving sizes were used during subsequent analyses to generate homegrown food intake rates for individual household members. Assuming that the proportion of the household quantity of each homegrown food item/group was a function of the number of meals and the mean sex- and age-specific serving size for each family member, individual intakes of home produced food were calculated for all members of the survey population using SAS programming in which the following general equation was used:



$$w_i = W_f \cdot \frac{m_i q_i}{\sum_{i=1}^n m_i q_i} \quad (\text{Eqn. 13-1})$$

where:

- $w_i$  = Homegrown amount of food item/group attributed to member  $i$  during the week (g/week);
- $W_f$  = Total quantity of homegrown food item/group used by the family members (g/week);
- $m_i$  = Number of meals of household food consumed by member  $i$  during the week (meals/week); and
- $q_i$  = Serving size for an individual within the age and sex category of the member (g/meal).

Daily intake of a homegrown food item/group was determined by dividing the weekly value ( $w_i$ ) by seven. Intake rates were indexed to the self-reported body weight of the survey respondent and reported in units of g/kg-day. Intake rates were not calculated for children under one year of age because their diet differs markedly from that of other household members, and thus the assumption that all household members share all foods would be invalid for this age group. In Section 13.5, a method for estimating per-capita homegrown intake in this age group is suggested.

For the major food groups (fruits, vegetables, meats, dairy, and fish) and individual foods consumed by at least 30 households, distributions of home produced intake among consumers were generated for the entire data set and according to the following subcategories: age groups, urbanization categories, seasons, racial classifications, regions, and responses to the questionnaire.

Consumers were defined as members of survey households who reported consumption of the food item/group of interest during the one week survey period. In addition, for the major food groups, distributions were generated for each region by season, urbanization, and responses to the questionnaire. Table 13-3 presents the codes, definitions, and a description of the data included in each of the subcategories. Intake rates were not calculated for food items/groups for which less than 30 households reported home produced usage because the number of observations may be inadequate for generating distributions that would be representative of that segment of consumers. Fruits and vegetables were also classified as exposed, protected, or roots, as shown in Appendix 13A of this document. Exposed foods are those that are grown above ground and are likely to be contaminated by pollutants deposited on surfaces that are eaten. Protected products are those that have outer protective coatings that are typically

removed before consumption. Distributions of intake were tabulated for these food classes for the same subcategories listed above. Distributions were also tabulated for the following USDA food classifications: dark green vegetables, deep yellow vegetables, other vegetables, citrus fruits, and other fruits. Finally, the percentages of total intake of the food items/groups consumed within survey households that can be attributed to home production were tabulated. The percentage of intake that was homegrown was calculated as the ratio of total intake of the homegrown food item/group by the survey population to the total intake of all forms of the food by the survey population.

As discussed in Section 13.3, percentiles of average daily intake derived from short time intervals (e.g., 7 days) will not, in general, be reflective of long term patterns. This is especially true regarding consumption of many homegrown products (e.g., fruits, vegetables), where there is often a strong seasonal component associated with their use. To try to derive, for the major food categories, the long term distribution of average daily intake rates from the short-term data available here, an approach was developed which attempted to account for seasonal variability in consumption. This approach used regional "seasonally adjusted distributions" to approximate regional long term distributions and then combined these regional adjusted distributions (in proportion to the weights for each region) to obtain a U.S. adjusted distribution which approximated the U.S. long term distribution.

The percentiles of the seasonally adjusted distribution for a given region were generated by averaging the corresponding percentiles of each of the four seasonal distributions of the region. More formally, the seasonally adjusted distribution for each region is such that its inverse cumulative distribution function is the average of the inverse cumulative distribution functions of each of the seasonal distributions of that region. The use of regional seasonally adjusted distributions to



*Chapter 13 - Intake Rates for Various Home Produced Food Items*

Table 13-3. Sub-category Codes and Definitions		
Code	Definition	Description
<b>Region<sup>a</sup></b>		
1	Northeast	Includes Connecticut, Maine, Massachusetts, New Hampshire, New Jersey, New York, Pennsylvania, Rhode Island, and Vermont
2	Midwest	Includes Illinois, Indiana, Iowa, Kansas, Michigan, Minnesota, Missouri, Nebraska, North Dakota, Ohio, South Dakota, and Wisconsin
3	South	Includes Alabama, Arkansas, Delaware, District of Columbia, Florida, Georgia, Kentucky, Louisiana, Maryland, Mississippi, North Carolina, Oklahoma, South Carolina, Tennessee, Texas, Virginia, and West Virginia
4	West	Includes Arizona, California, Colorado, Idaho, Montana, Nevada, New Mexico, Oregon, Utah, Washington, and Wyoming
<b>Urbanization</b>		
1	Central City	Cities with populations of 50,000 or more that is the main city within the metropolitan statistical area (MSA).
2	Suburban	An area that is generally within the boundaries of an MSA, but is not within the legal limit of the central city.
3	Nonmetropolitan	An area that is not within an MSA.
<b>Race</b>		
1	--	White (Caucasian)
2	--	Black
3	--	Asian and Pacific Islander
4	--	Native American, Aleuts, and Eskimos
5, 8, 9	Other/NA	Don't know, no answer, some other race
<b>Responses to Survey Questions</b>		
Grow	Question 75	Did anyone in the household grow any vegetables or fruit for use in the household?
Raise Animals	Question 76	Did anyone in the household produce any animal products such as milk, eggs, meat, or poultry for home use in your household?
Fish/Hunt	Question 77	Did anyone in the household catch any fish or shoot game for home use?
Farm	Question 79	Did anyone in the household operate a farm or ranch?
<b>Season</b>		
Spring	-	April, May, June
Summer	-	July, August, September
Fall	-	October, November, December
Winter	-	January, February, March
<sup>a</sup> Alaska and Hawaii were not included. Source: USDA 1987-88.		

approximate regional long term distributions is based on the assumption that each individual consumes at the same regional percentile levels for each season and consumes at a constant weekly rate throughout a given season. Thus, for instance, if the 60th percentile weekly intake level in the South is 14.0 g in the summer and 7.0 g in each of the three other seasons, then an individual in the South with an average weekly intake of 14.0 g over the summer would be assumed to have an intake of 14.0 g for each week of the

summer and an intake of 7.0 g for each week of the other seasons.

Note that the seasonally adjusted distributions derived above were generated using the overall distributions, i.e., both consumers and non-consumers. However, since all the other distributions presented in this section are based on consumers only, the percentiles for the adjusted distributions have been revised to reflect the percentiles among consumers only. Given the above assumption about



Chapter 13 - Intake Rates for Various Home Produced Food Items

how each individual consumes, the percentage consuming for the seasonally adjusted distributions give an estimate of the percentage of the population consuming the specified food category at any time during the year.

The intake data presented here for consumers of home produced foods and the total number of individuals surveyed may be used to calculate the mean and the percentiles of the distribution of home produced food consumption in the overall population (consumers and non-consumers) as follows:

Assuming that  $IR_p$  is the homegrown intake rate of food item/group at the  $p^{th}$  percentile and  $N_c$  is the weighted number of individuals consuming the homegrown food item, and  $N_T$  is the weighted total number of individuals surveyed, then  $N_T - N_c$  is the weighted number of individuals who reported zero consumption of the food item. In addition, there are  $(p/100 \times N_c)$  individuals below the  $p^{th}$  percentile. Therefore, the percentile that corresponds to a particular intake rate ( $IR_p$ ) for the overall distribution of homegrown food consumption (including consumers and nonconsumers) can be obtained by:

$$P_{overall}^{th} = 100 \times \frac{\left( \frac{P}{100} \times N_c + (N_T - N_c) \right)}{N_T} \quad (\text{Eqn. 13-2})$$

For example, the percentile of the overall population that is equivalent to the 50th percentile consumer only intake rate for homegrown fruits would be calculated as follows:

From Table 13-8, the 50th percentile homegrown fruit intake rate ( $IR_{50}$ ) is 1.07 g/kg-day. The weighted number of individuals consuming fruits ( $N_c$ ) is 14,744,000. From Table 13-4, the weighted total number of individuals surveyed ( $N_T$ ) is 188,019,000. The number of individuals consuming fruits below the 50th percentile is:

$$p/100 \times N_c = (0.5) \times (14,744,000) = 7,372,000$$

The number of individuals that did not consume fruit during the survey period is:

$$N_T - N_c = 188,019,000 - 14,744,000 = 173,275,000$$

The total number of individuals with homegrown intake rates at or below 1.07 g/kg-day is

$$(p/100 \times N_c) + (N_T - N_c) = 7,372,000 + 173,275,000 = 180,647,000$$

The percentile of the overall population that is represented by this intake rate is:

$$P_{overall}^{th} = 100 \times (180,647,000 / 188,109,000) = 96th \text{ percentile}$$

Therefore, an intake rate of 1.07 g/kg-day of homegrown fruit corresponds to the 96th percentile of the overall population.

Following the same procedure described above, 5.97 g/kg-day, which is the 90th percentile of the consumers only population, corresponds to the 99th percentile of the overall population. Likewise, 0.063 g/kg-day, which is the 1st percentile of the consumers only population, corresponds to the 92nd percentile of the overall population. Note that the consumers only distribution corresponds to the tail of the distribution for the overall population. Consumption rates below the 92nd percentile are very close to zero. The mean intake rate for the overall population can be calculated by multiplying the mean intake rate among consumers by the proportion of individuals consuming the homegrown food item,  $N_c/N_T$ .

Table 13-4 displays the weighted numbers  $N_T$ , as well as the unweighted total survey sample sizes, for each subcategory and overall. It should be noted that the total unweighted number of observations in Table 13-4 (9,852) is somewhat lower than the number of observations reported by USDA because this study only used observations for family members for which age and body weight were specified.





Table 13-4. Weighted and Unweighted Number of Observations (Individuals) for NFCS Data Used in Analysis of Food Intake

	All Regions		Northeast		Midwest		South		West	
	wgtd	unwgtd	wgtd	unwgtd	wgtd	unwgtd	wgtd	unwgtd	wgtd	unwgtd
<b>Total</b>	188019000	9852	41167000	2018	46395000	2592	64331000	3399	36066000	1841
<b>Age (years)</b>										
< 01	2814000	156	545000	29	812000	44	889000	51	568000	32
01-02	5699000	321	1070000	56	1757000	101	1792000	105	1080000	59
03-05	8103000	461	1490000	92	2251000	133	2543000	140	1789000	95
06-11	16711000	937	3589000	185	4263000	263	5217000	284	3612000	204
12-19	20488000	1084	4445000	210	5490000	310	6720000	369	3833000	195
20-39	61606000	3058	12699000	600	15627000	823	21786000	1070	11494000	565
40-69	56718000	3039	13500000	670	13006000	740	19635000	1080	10577000	549
70 +	15880000	796	3829000	176	3189000	178	5749000	300	3113000	142
<b>Season</b>										
Fall	47667000	1577	9386000	277	14399000	496	13186000	439	10696000	365
Spring	46155000	3954	10538000	803	10657000	1026	16802000	1437	8158000	688
Summer	45485000	1423	9460000	275	10227000	338	17752000	562	7986000	246
Winter	48712000	2898	11783000	663	11112000	732	16591000	961	9226000	542
<b>Urbanization</b>										
Central City	56352000	2217	9668000	332	17397000	681	17245000	715	12042000	489
Nonmetropolitan	45023000	3001	5521000	369	14296000	1053	19100000	1197	6106000	382
Suburban	86584000	4632	25978000	1317	14702000	858	27986000	1487	17918000	970
<b>Race</b>										
Asian	2413000	114	333000	13	849000	37	654000	32	577000	32
Black	21746000	1116	3542000	132	2794000	126	13701000	772	1709000	86
Native American	1482000	91	38000	4	116000	6	162000	8	1166000	73
Other/NA	4787000	235	1084000	51	966000	37	1545000	86	1192000	61
White	157531000	8294	36170000	1818	41670000	2386	48269000	2501	31422000	1589
<b>Response to Questionnaire</b>										
Do you garden?	68152000	3744	12501000	667	22348000	1272	20518000	1136	12725000	667
Do you raise animals?	10097000	631	1178000	70	3742000	247	2603000	162	2574000	152
Do you hunt?	20216000	1148	3418000	194	6948000	411	6610000	366	3240000	177
Do you fish?	39733000	2194	5950000	321	12621000	725	13595000	756	7567000	392
Do you farm?	7329000	435	830000	42	2681000	173	2232000	130	1586000	90



Chapter 13 - Intake Rates for Various Home Produced Food Items

As mentioned above, the intake rates derived in this section are based on the amount of household food consumption. As measured by the NFCS, the amount of food “consumed” by the household is a measure of consumption in an economic sense, i.e., a measure of the weight of food brought into the household that has been consumed (used up) in some manner. In addition to food being consumed by persons, food may be used up by spoiling, by being discarded (e.g., inedible parts), through cooking processes, etc.

USDA estimated preparation losses for various foods (USDA, 1975). For meats, a net cooking loss, which includes dripping and volatile losses, and a net post cooking loss, which involves losses from cutting, bones, excess fat, scraps and juices, were derived for a variety of cuts and cooking methods. For each meat type (e.g., beef) EPA has averaged these losses across all cuts and cooking methods to obtain a mean net cooking loss and a mean net post cooking loss; these are displayed in Table 13-5. For individual fruits and vegetables, USDA (1975) also gave cooking and post-cooking losses. These data are presented in Tables 13-6 and 13-7.

The following formulas can be used to convert the intake rates tabulated here to rates reflecting actual consumption:

$$I_A = I \times (1 - L_1) \times (1 - L_2) \quad (\text{Eqn. 13-3})$$

$$I_A = I \times (1 - L_p) \quad (\text{Eqn. 13-4})$$

where  $I_A$  is the adjusted intake rate,  $I$  is the tabulated intake rate,  $L_1$  is the cooking loss,  $L_2$  is the post-cooking loss and  $L_p$  is the paring or preparation loss. For fruits, corrections based on postcooking losses only apply to fruits that are eaten in cooked forms. For raw forms of the fruits, paring or preparation loss data should be used to correct for losses from removal of skin, peel, core, caps, pits, stems, and defects, or draining of liquids from canned or frozen forms. To obtain preparation losses for food categories, the preparation losses of the individual foods making up the category can be averaged.

In calculating ingestion exposure, assessors should use consistent forms in combining intake rates with contaminant concentrations. This issue has been previously discussed in the other food Chapters.

13.3. RESULTS

The intake rate distributions (among consumers) for total home produced fruits, vegetables, meats, fish and dairy products are shown, respectively, in Tables 13-8 through 13-32 (displayed at the end of Chapter 13). Also shown in these tables is the proportion of respondents consuming the item during the (one-week) survey period. Homegrown vegetables were the most commonly consumed of the major food groups (18.3%), followed by fruit (7.8%), meat (4.9%), fish (2.1%), and dairy products (0.7%). The intake rates for the major food groups vary according to region, age, urbanization code, race, and response to survey questions. In general, intake rates of home produced foods are higher among populations in non-metropolitan and suburban areas and lowest in central city areas. Results of the regional analyses indicate that intake of homegrown fruits, vegetables, meat and dairy products is generally highest for individuals in the Midwest and South and lowest for those in the Northeast. Intake rates of home caught fish were generally highest among consumers in the South. Homegrown intake was generally higher among individuals who indicated that they operate a farm, grow their own vegetables, raise animals, and catch their own fish. The results of the seasonal analyses for all regions combined indicated that, in general, homegrown fruits and vegetables were eaten at a higher rate in summer, and home caught fish was consumed at a higher rate in spring; however, seasonal intake varied based on individual regions. Seasonally adjusted intake rate distributions for the major food groups are presented in Table 13-33.

Tables 13-34 through 13-60 present distributions of intake for individual home produced food items for households that reported consuming the homegrown form of the food during the survey period. Intake rate distributions among consumers for homegrown foods categorized as exposed fruits and vegetables, protected fruits and vegetables, and root vegetables are presented in Tables 13-61 through 13-65; the intake distributions for various USDA classifications (e.g., dark green vegetables) are presented in Tables 13-66 through 13-70. The results are presented in units of g/kg-day. Table 13-71 presents the fraction of household intake attributed to home produced forms of the food items/groups evaluated. Thus, use of these data in calculating potential dose does not require the body weight factor to be included in the denominator of the average daily dose (ADD) equation. It should be noted that converting these intake rates into units of g/day by multiplying by a single average body



Table 13-5. Percent Weight Losses from Preparation of Various Meats

Meat Type	Mean Net Cooking Loss (%) <sup>a</sup>			Mean Net Post Cooking Loss (%) <sup>b</sup>		
	Mean	Range of Means	Standard Deviation	Mean	Range of Means	Standard Deviation
Beef	27	11 to 42	7	24	10 to 46	9
Pork	28	1 to 67	10	36	14 to 52	11
Chicken	32	7 to 55	9	31	16 to 51	8
Turkey	32	11 to 57	7	28	8 to 48	10
Lamb	30	25 to 37	5	34	14 to 61	14
Veal	29	10 to 45	11	25	18 to 37	9
Fish <sup>c</sup>	30	-19 to 81	19	11	1 to 26	6
Shellfish <sup>d</sup>	33	1 to 94	30	10	10 to 10	0

<sup>a</sup> Includes dripping and volatile losses during cooking. Averaged over various cuts and preparation methods.  
<sup>b</sup> Includes losses from cutting, shrinkage, excess fat, bones, scraps, and juices. Averaged over various cuts and preparation methods.  
<sup>c</sup> Averaged over a variety of fish, to include: bass, bluefish, butterfish, cod, flounder, haddock, halibut, lake trout, makerel, perch, porgy, red snapper, rockfish, salmon, sea trout, shad, smelt, sole, spot, squid, swordfish steak, trout, and whitefish.  
<sup>d</sup> Averaged over a variety of shellfish, to include: clams, crab, crayfish, lobster, oysters, and shrimp and shrimp dishes.

Source: USDA, 1975.

Table 13-6. Percent Weight Losses from Preparation of Various Fruits

Type of Fruit	Mean Net Post Cooking Loss (%) <sup>a</sup>			Mean Paring or Preparation Loss (%) <sup>b,c</sup>		
	Mean	Range of Means	Standard Deviation	Mean	Range of Means	Standard
Apples	25	3 to 42	13	22 <sup>b</sup>	13 to 40 <sup>b</sup>	NA <sup>b</sup>
Pears	--	--	--	22 <sup>b</sup>	12 to 60 <sup>b</sup>	NA <sup>b</sup>
Peaches	36	19 to 50	12	41 <sup>c</sup>	25 to 47 <sup>c</sup>	NA <sup>c</sup>
Strawberries	--	--	--	24 <sup>b</sup>	6 to 68 <sup>b</sup>	NA <sup>b</sup>
Oranges	--	--	--	10 <sup>b</sup>	6 to 14 <sup>b</sup>	NA <sup>b</sup>
				30 <sup>c</sup>	96 to 41 <sup>c</sup>	15 <sup>c</sup>
				29 <sup>b</sup>	19 to 38 <sup>b</sup>	NA <sup>b</sup>

<sup>a</sup> Includes losses from draining cooked forms.  
<sup>b</sup> Includes losses from removal of skin or peel, core or pit, stems or caps, seeds and defects.  
<sup>c</sup> Includes losses from removal of drained liquids from canned or frozen forms.

Source: USDA, 1975



Table 13-7. Percent Weight Losses from Preparation of Various Vegetables

Type of Vegetable	Mean Net Cooking Loss (%) <sup>a</sup>			Mean Net Post Cooking Loss (%) <sup>b</sup>		
	Mean	Range of Means	Standard Deviation	Mean	Range of Means	Standard Deviation
Asparagus	23	5 to 47	16	--	--	--
Beets	28	4 to 60	17	--	--	--
Broccoli	14	0 to 39	13	--	--	--
Cabbage	11	4 to 20	6	--	--	--
Carrots	19	2 to 41	12	--	--	--
Corn	26	-1 to 64	22	--	--	--
Cucumbers	18	5 to 40	14	--	--	--
Lettuce	22	6 to 36	12	--	--	--
Lima Beans	-12	-143 to 56	69	--	--	--
Okra	12	-10 to 40	16	--	--	--
Onions	5	-90 to 63	38	--	--	--
Peas, green	2	-147 to 62	63	--	--	--
Peppers	13	3 to 27	9	--	--	--
Pumpkins	19	8 to 30	11	--	--	--
Snap Beans	18	5 to 42	13	--	--	--
Tomatoes	15	2 to 34	10	--	--	--
Potatoes	-22	-527 to 46	121	22	1 to 33	11

<sup>a</sup> Includes losses due to paring, trimming, flowering the stalk, thawing, draining, scraping, shelling, slicing, husking, chopping, and dicing and gains from the addition of water, fat, or other ingredients. Averaged over various preparation methods.

<sup>b</sup> Includes losses from draining or removal of skin.

Source: USDA, 1975

weight is inappropriate, because individual intake rates were indexed to the reported body weights of the survey respondents. However, if there is a need to compare the total intake data presented here to other intake data in units of g/day, a body weight less than 70 kg (i.e., approximately 60 kg; calculated based on the number of respondents in each age category and the average body weights for these age groups, as presented in Volume I, Chapter 7) should be used because the total survey population included children as well as adults.

**13.4. ADVANTAGES AND LIMITATIONS**

The USDA NFCS data set is the largest publicly available source of information on food consumption habits in the United States. The advantages of using this data set are that it is expected to be representative of the U.S. population and that it provides information on a wide variety of food groups. However, the data collected by the USDA NFCS are based on short-term dietary recall and the intake distributions generated from them may not accurately reflect long-term intake patterns, particularly with respect to the tails (extremes) of the distributions. Also, the two

survey components (i.e., household and individual) do not define food items/groups in a consistent manner; as a result, some errors may be introduced into these analyses because the two survey components are linked. The results presented here may also be biased by assumptions that are inherent in the analytical method utilized. The analytical method may not capture all high-end consumers within households because average serving sizes are used in calculating the proportion of homegrown food consumed by each household member. Thus, for instance, in a two-person household where one member had high intake and one had low intake, the method used here would assume that both members had an equal and moderate level of intake. In addition, the analyses assume that all family members consume a portion of the home produced food used within the household. However, not all family members may consume each home produced food item and serving sizes allocated here may not be entirely representative of the portion of household foods consumed by each family member. As was mentioned in Section 13.2, no analyses were performed for the under 1 year age group due to the above concerns. Below, in Section 13.5, a



*Chapter 13 - Intake Rates for Various Home Produced Food Items*

recommended approach for dealing with this age group is presented.

The preparation loss factors discussed in Section 13.2 are intended to convert intake rates based on "household consumption" to rates reflective of what individuals actually consume. However, these factors do not include losses to spoilage, feeding to pets, food thrown away, etc.

It should also be noted that because this analysis is based on the 1987-88 NFCS, it may not reflect recent changes in food consumption patterns. The low response rate associated with the 1987-88 NFCS also contributes to the uncertainty of the homegrown intake rates generated using these data.

**13.5. RECOMMENDATIONS**

The distribution data presented in this study may be used to assess exposure to contaminants in foods grown, raised, or caught at a specific site. Table 13-72 presents the confidence ratings for homegrown food intake. The recommended values for mean intake rates among consumers for the various home produced foods can be taken from the tables presented here; these can be converted to per capita rates by multiplying by the fraction consuming. The data presented here for consumers of home produced foods represent average daily intake rates of food items/groups over the seven-day survey period and do not account for variations in eating habits during the rest of the year; thus the percentiles presented here (except the seasonally adjusted) are only valid when considering exposures over time periods of about one week. Similarly, the figures for percentage consuming are also only valid over a one week time period. Since the tabulated percentiles reflect the distribution among consumers only, Eqn. 13-2 must be used to convert the percentiles shown here to ones valid for the general population.

In contrast, the seasonally adjusted percentiles are designed to give percentiles of the long term distribution of average daily intake and the percentage consuming shown with this distribution is designed to estimate the percent of the population consuming at any time during a year. However, because the assumptions mentioned in Section 13.2 can not be verified to hold, these upper percentiles must be assigned a low confidence rating. Eqn. 13-2 may also be used with this distribution to convert percentiles among consumers to percentiles for the general population.

For all the rates tabulated here, preparation loss factors should be applied, where appropriate. The form of

the food used to estimate intake should be consistent with the form used to measure contaminant concentration.

As described above, the tables do not display rates for children under 1 year of age. For this age group, it is recommended that per-capita homegrown consumption rates be estimated using the following approach. First, for each specific home produced food of interest, the ratio of per capita intake for children under 1 year compared to that of children 1 to 2 years is calculated using the USDA CSFII 1989-1991 results displayed in Volume II, Chapters 9 and 11. Note these results are based on individual food intakes; however, they consider all sources of food, not just home produced. Second, the per-capita intake rate in the 1 to 2 year age group of the home produced food of interest is calculated as described above by multiplying the fraction consuming by the mean intake rate among consumers (both these numbers are displayed in the tables). Finally, the per capita homegrown intake rate in children under 1 year of the food of interest is estimated by multiplying the homegrown per-capita intake rate in the 1 to 2 year age group by the above ratio of intakes in the under 1 year age group as compared to the 1 to 2 year age group.

The AIHC Sourcebook (AIHC, 1994) used data presented in the 1989 version of the Exposure Factors Handbook which reported data from the USDA 1977-78 NFCS. In this Handbook, new analyses of more recent data from USDA were conducted. Numbers, however, cannot be directly compared with previous values since the results from the new analyses are presented on a body weight basis.

**13.6. REFERENCES FOR CHAPTER 13**

- American Industrial Health Council (AIHC) (1994) Exposure factors sourcebook. AIHC, Washington, DC.
- National Gardening Association. (1987) National gardening survey: 1986-1987. Burlington, Vermont: The National Gardening Association, Inc.
- USDA. (1975) Food yields summarized by different stages of preparation. Agriculture Handbook No. 102. U.S. Department of Agriculture, Agricultural Research Service, Washington, DC.



USDA. (1987-88) Dataset: Nationwide Food Consumption Survey 1987/88 Household Food Use. U.S. Department of Agriculture. Washington, D.C. 1987/88 NFCS Database.

USDA. (1992) Changes in food consumption and expenditures in American households during the 1980's. U.S. Department of Agriculture. Washington, D.C. Statistical Bulletin No. 849.

USDA. (1993) Food and nutrient intakes by individuals in the United States, 1 Day, 1987-88. Nationwide Food Consumption Survey 1987-88, NFCS Report No. 87-I-1.

USDA. (1994) Food consumption and dietary levels of households in the United States, 1987-88. U.S. Department of Agriculture, Agricultural Research Service. Report No. 87-H-1.



Table 13-8. Consumer Only Intake of Homegrown Fruits (g/kg-day) - All Regions Combined

Population Group	Nc wgtd	Nc unwgtd	% Consuming	Mean	SE	P1	P5	P10	P25	P50	P75	P90	P95	P99	P100
<b>Total</b>	14744000	817	7.84	2.68E+00	1.89E-01	6.26E-02	1.68E-01	2.78E-01	4.97E-01	1.07E+00	2.37E+00	5.97E+00	1.11E+01	2.40E+01	6.06E+01
<b>Age (years)</b>															
01-02	360000	23	6.32	8.74E+00	3.10E+00	9.59E-01	1.09E+00	1.30E+00	1.64E+00	3.48E+00	7.98E+00	1.93E+01	6.06E+01	6.06E+01	6.06E+01
03-05	550000	34	6.79	4.07E+00	1.48E+00	1.00E-02	1.00E-02	3.62E-01	9.77E-01	1.92E+00	2.73E+00	6.02E+00	8.91E+00	4.83E+01	4.83E+01
06-11	1044000	75	6.25	3.59E+00	6.76E-01	1.00E-02	1.91E-01	4.02E-01	6.97E-01	1.31E+00	3.08E+00	1.18E+01	1.58E+01	3.22E+01	3.22E+01
12-19	1189000	67	5.80	1.94E+00	3.66E-01	8.74E-02	1.27E-01	2.67E-01	4.41E-01	6.61E-01	2.35E+00	6.76E+00	8.34E+00	1.85E+01	1.85E+01
20-39	3163000	164	5.13	1.95E+00	3.33E-01	8.14E-02	1.28E-01	2.04E-01	3.74E-01	7.03E-01	1.77E+00	4.17E+00	6.84E+00	1.61E+01	3.70E+01
40-69	5633000	309	9.93	2.66E+00	3.04E-01	6.26E-02	1.91E-01	2.86E-01	4.69E-01	1.03E+00	2.33E+00	5.81E+00	1.30E+01	2.38E+01	5.33E+01
70 +	2620000	134	16.50	2.25E+00	2.34E-01	4.41E-02	2.24E-01	3.80E-01	6.11E-01	1.18E+00	2.35E+00	5.21E+00	8.69E+00	1.17E+01	1.53E+01
<b>Season</b>															
Fall	3137000	108	6.58	1.57E+00	1.59E-01	2.63E-01	3.04E-01	3.90E-01	5.70E-01	1.04E+00	1.92E+00	3.48E+00	4.97E+00	1.06E+01	1.06E+01
Spring	2963000	301	6.42	1.58E+00	1.37E-01	8.89E-02	1.98E-01	2.54E-01	4.23E-01	8.57E-01	1.70E+00	4.07E+00	5.10E+00	8.12E+00	3.17E+01
Summer	4356000	145	9.58	3.86E+00	6.40E-01	1.00E-02	9.18E-02	1.56E-01	4.45E-01	1.26E+00	3.31E+00	1.09E+01	1.46E+01	5.33E+01	6.06E+01
Winter	4288000	263	8.80	3.08E+00	3.41E-01	4.41E-02	1.72E-01	2.69E-01	5.56E-01	1.15E+00	2.61E+00	8.04E+00	1.53E+01	2.49E+01	4.83E+01
<b>Urbanization</b>															
Central City	3668000	143	6.51	2.31E+00	2.64E-01	4.41E-02	1.82E-01	3.33E-01	5.67E-01	1.08E+00	2.46E+00	5.34E+00	1.05E+01	1.43E+01	1.93E+01
Nonmetropolitan	4118000	278	9.15	2.41E+00	3.09E-01	6.26E-02	1.27E-01	2.32E-01	4.50E-01	1.15E+00	2.42E+00	4.46E+00	8.34E+00	2.40E+01	5.33E+01
Suburban	6898000	394	7.97	3.07E+00	3.22E-01	1.25E-01	2.30E-01	2.95E-01	4.91E-01	9.93E-01	2.33E+00	7.26E+00	1.52E+01	3.70E+01	6.06E+01
<b>Race</b>															
Black	450000	20	2.07	1.87E+00	8.53E-01	1.32E-01	2.84E-01	4.55E-01	6.08E-01	1.13E+00	1.53E+00	2.29E+00	2.29E+00	1.93E+01	1.93E+01
White	14185000	793	9.00	2.73E+00	1.94E-01	7.22E-02	1.82E-01	2.82E-01	5.10E-01	1.07E+00	2.46E+00	6.10E+00	1.17E+01	2.40E+01	6.06E+01
<b>Questionnaire Response</b>															
Households who garden	12742000	709	18.70	2.79E+00	2.10E-01	5.60E-02	1.84E-01	2.87E-01	5.30E-01	1.12E+00	2.50E+00	6.10E+00	1.18E+01	2.49E+01	6.06E+01
Households who farm	1917000	112	26.16	2.58E+00	2.59E-01	7.22E-02	2.76E-01	4.13E-01	7.53E-01	1.61E+00	3.62E+00	5.97E+00	7.82E+00	1.58E+01	1.58E+01
NOTE: SE = standard error P = percentile of the distribution Nc wgtd = weighted number of consumers; Nc unwgtd = unweighted number of consumers in survey. Source: Based on EPA's analyses of the 1987/88 NFCS															



Table 13-9. Consumer Only Intake of Homegrown Fruits (g/kg-day) - Northeast

Population Group	Nc wgted	Nc unwtgd	% Consuming	Mean	SE	P1	P5	P10	P25	P50	P75	P90	P95	P99	P100
Total	1279000	72	3.11	9.29E-01	2.20E-01	7.91E-02	8.48E-02	1.61E-01	3.11E-01	4.85E-01	7.82E-01	1.29E+00	2.16E+00	1.17E+01	1.17E+01
Season															
Fall	260000	8	2.77	*	*	*	*	*	*	*	*	*	*	*	*
Spring	352000	31	3.34	8.80E-01	2.32E-01	8.74E-02	1.61E-01	1.68E-01	2.87E-01	4.85E-01	8.79E-01	1.83E+00	2.16E+00	7.13E+00	7.13E+00
Summer	271000	9	2.86	*	*	*	*	*	*	*	*	*	*	*	*
Winter	396000	24	3.36	7.10E-01	1.13E-01	1.84E-01	2.07E-01	2.30E-01	2.93E-01	5.42E-01	8.81E-01	1.38E+00	1.79E+00	2.75E+00	2.75E+00
Urbanization															
Central City	50000	3	0.52	*	*	*	*	*	*	*	*	*	*	*	*
Nonmetropolitan	176000	10	3.19	*	*	*	*	*	*	*	*	*	*	*	*
Suburban	1053000	59	4.05	1.05E+00	2.63E-01	1.84E-01	2.30E-01	2.93E-01	4.37E-01	5.43E-01	8.12E-01	1.29E+00	2.75E+00	1.17E+01	1.17E+01
Questionnaire Response															
Households who garden	983000	59	7.86	1.04E+00	2.64E-01	8.74E-02	1.82E-01	2.13E-01	3.75E-01	5.43E-01	8.81E-01	1.38E+00	2.75E+00	1.17E+01	1.17E+01
Households who farm	132000	4	15.90	*	*	*	*	*	*	*	*	*	*	*	*

\* Intake data not provided for subpopulations for which there were less than 20 observations

NOTE: SE = standard error  
P = percentile of the distribution  
Nc wgted = weighted number of consumers; Nc unwtgd = unweighted number of consumers in survey.  
Source: Based on EPA's analyses of the 1987-88 NFCS

Table 13-10. Consumer Only Intake of Homegrown Fruits (g/kg-day) - Midwest

Population Group	Nc wgted	Nc unwtgd	% Consuming	Mean	SE	P1	P5	P10	P25	P50	P75	P90	P95	P99	P100
Total	4683000	302	10.09	3.01E+00	4.13E-01	4.41E-02	1.25E-01	2.35E-01	4.68E-01	1.03E+00	2.31E+00	6.76E+00	1.39E+01	5.33E+01	6.06E+01
Season															
Fall	1138000	43	7.90	1.54E+00	1.86E-01	2.63E-01	3.04E-01	4.74E-01	6.11E-01	1.07E+00	1.92E+00	3.48E+00	4.34E+00	5.33E+00	5.33E+00
Spring	1154000	133	10.83	1.69E+00	2.76E-01	8.89E-02	2.09E-01	2.62E-01	4.23E-01	9.23E-01	1.72E+00	2.89E+00	4.47E+00	1.60E+01	3.17E+01
Summer	1299000	44	12.70	7.03E+00	1.85E+00	6.26E-02	9.18E-02	1.25E-01	4.28E-01	1.55E+00	8.34E+00	1.61E+01	3.70E+01	6.06E+01	6.06E+01
Winter	1092000	82	9.83	1.18E+00	1.80E-01	2.57E-02	5.60E-02	1.46E-01	3.62E-01	6.09E-01	1.42E+00	2.61E+00	3.73E+00	1.09E+01	1.09E+01
Urbanization															
Central City	1058000	42	6.08	1.84E+00	3.93E-01	4.15E-02	1.01E-01	2.63E-01	5.21E-01	1.07E+00	1.90E+00	2.82E+00	9.74E+00	1.09E+01	1.09E+01
Nonmetropolitan	1920000	147	13.43	2.52E+00	5.43E-01	5.60E-02	1.08E-01	1.46E-01	3.96E-01	1.03E+00	2.07E+00	4.43E+00	6.84E+00	5.33E+01	5.33E+01
Suburban	1705000	113	11.60	4.29E+00	8.72E-01	9.18E-02	2.04E-01	3.10E-01	4.81E-01	7.64E-01	3.01E+00	1.39E+01	1.80E+01	6.06E+01	6.06E+01
Response to Questionnaire															
Households who garden	4060000	267	18.17	3.27E+00	4.69E-01	4.41E-02	1.01E-01	2.04E-01	4.48E-01	1.07E+00	2.37E+00	7.15E+00	1.46E+01	5.33E+01	6.06E+01
Households who farm	694000	57	25.89	2.59E+00	3.01E-01	5.60E-02	1.91E-01	4.08E-01	1.26E+00	1.63E+00	3.89E+00	6.76E+00	8.34E+00	1.11E+01	1.11E+01

NOTE: SE = standard error  
P = percentile of the distribution  
Nc wgted = weighted number of consumers; Nc unwtgd = unweighted number of consumers in survey.  
Source: Based on EPA's analyses of the 1987-88 NFCS





Table 13-11. Consumer Only Intake of Homegrown Fruits (g/kg-day) - South

Population Group	Nc wgted	Nc unwgted	% Consuming	Mean	SE	P1	P5	P10	P25	P50	P75	P90	P95	P99	P100
Total	4148000	208	6.45	2.97E+00	3.00E-01	1.12E-01	2.42E-01	3.55E-01	5.97E-01	1.35E+00	3.01E+00	8.18E+00	1.41E+01	2.38E+01	2.40E+01
Season															
Fall	896000	29	6.80	1.99E+00	4.39E-01	3.92E-01	4.27E-01	4.46E-01	6.50E-01	1.13E+00	1.96E+00	4.97E+00	8.18E+00	1.06E+01	1.06E+01
Spring	620000	59	3.69	2.05E+00	2.55E-01	1.55E-01	2.82E-01	3.11E-01	4.50E-01	1.06E+00	4.09E+00	5.01E+00	6.58E+00	7.05E+00	7.05E+00
Summer	1328000	46	7.48	2.84E+00	6.50E-01	8.14E-02	1.56E-01	2.67E-01	4.41E-01	1.31E+00	2.83E+00	6.10E+00	1.43E+01	2.40E+01	2.40E+01
Winter	1304000	74	7.86	4.21E+00	6.51E-01	1.12E-01	2.36E-01	3.82E-01	8.92E-01	1.88E+00	3.71E+00	1.41E+01	1.97E+01	2.38E+01	2.38E+01
Urbanization															
Central City	1066000	39	6.18	3.33E+00	5.39E-01	2.36E-01	3.92E-01	4.55E-01	8.34E-01	2.55E+00	4.77E+00	8.18E+00	1.06E+01	1.43E+01	1.43E+01
Nonmetropolitan	1548000	89	8.10	2.56E+00	3.87E-01	8.14E-02	2.67E-01	3.38E-01	6.12E-01	1.40E+00	2.83E+00	5.97E+00	1.04E+01	2.40E+01	2.40E+01
Suburban	1534000	80	5.48	3.14E+00	6.02E-01	1.12E-01	1.56E-01	2.84E-01	5.08E-01	1.10E+00	2.29E+00	1.18E+01	1.55E+01	2.38E+01	2.38E+01
Response to Questionnaire															
Households who garden	3469000	174	16.91	2.82E+00	2.94E-01	1.56E-01	2.84E-01	3.84E-01	6.50E-01	1.39E+00	2.94E+00	6.10E+00	1.41E+01	2.11E+01	2.40E+01
Households who farm	296000	16	13.26	*	*	*	*	*	*	*	*	*	*	*	*

\* Intake data not provided for subpopulatin for which there were less than 20 observations

NOTE: SE = standard error  
P = percentile of the distribution  
Nc wgted = weighted number of consumers; Nc unwgted = unweighted number of consumers in survey.  
Source: Based on EPA's analyses of the 1987-88 NFCS

Table 13-12. Consumer Only Intake of Homegrown Fruits (g/kg-day) - West

Population Group	Nc wgted	Nc unwgted	% Consuming	Mean	SE	P1	P5	P10	P25	P50	P75	P90	P95	P99	P100
Total	4574000	233	12.68	2.62E+00	3.07E-01	1.50E-01	2.75E-01	3.33E-01	6.17E-01	1.20E+00	2.42E+00	5.39E+00	1.09E+01	2.49E+01	4.83E+01
Season															
Fall	843000	28	7.88	1.47E+00	2.49E-01	2.91E-01	2.91E-01	2.95E-01	4.83E-01	1.04E+00	2.15E+00	2.99E+00	4.65E+00	5.39E+00	5.39E+00
Spring	837000	78	10.26	1.37E+00	1.59E-01	1.73E-01	1.96E-01	2.51E-01	5.10E-01	9.81E-01	1.61E+00	2.95E+00	5.29E+00	6.68E+00	7.02E+00
Summer	1398000	44	17.51	2.47E+00	4.72E-01	1.86E-01	2.75E-01	4.04E-01	6.17E-01	1.28E+00	3.14E+00	7.26E+00	1.09E+01	1.30E+01	1.30E+01
Winter	1496000	83	16.22	4.10E+00	7.91E-01	7.14E-02	2.96E-01	3.33E-01	7.74E-01	1.51E+00	3.74E+00	1.11E+01	1.85E+01	4.83E+01	4.83E+01
Urbanization															
Central City	1494000	59	12.41	1.99E+00	4.24E-01	7.14E-02	2.35E-01	3.42E-01	5.26E-01	8.63E-01	2.04E+00	4.63E+00	9.52E+00	1.93E+01	1.93E+01
Nonmetropolitan	474000	32	7.76	2.24E+00	5.25E-01	1.84E-01	2.76E-01	4.24E-01	6.25E-01	7.68E-01	2.64E+00	4.25E+00	1.09E+01	1.09E+01	1.09E+01
Suburban	2606000	142	14.54	3.04E+00	4.63E-01	1.83E-01	2.75E-01	3.14E-01	7.10E-01	1.39E+00	3.14E+00	5.81E+00	1.03E+01	3.22E+01	4.83E+01
Response to Questionnaire															
Households who garden	4170000	207	32.77	2.76E+00	3.39E-01	1.00E-01	2.75E-01	3.14E-01	6.29E-01	1.20E+00	2.54E+00	5.81E+00	1.09E+01	2.49E+01	4.83E+01
Households who farm	795000	35	50.13	1.85E+00	2.59E-01	2.75E-01	2.76E-01	5.98E-01	7.10E-01	1.26E+00	2.50E+00	4.63E+00	5.00E+00	6.81E+00	6.81E+00

NOTE: SE = standard error  
P = percentile of the distribution  
Nc wgted = weighted number of consumers; Nc unwgted = unweighted number of consumers in survey.  
Source: Based on EPA's analyses of the 1987-88 NFCS



Table 13-13. Consumer Only Intake of Homegrown Vegetables (g/kg-day) - All Regions Combined

Population Group	Nc wgted	Nc unwtgd	% Consuming	Mean	SE	P1	P5	P10	P25	P50	P75	P90	P95	P99	P100
Total	34392000	1855	18.29	2.08E+00	6.76E-02	4.79E-03	1.10E-01	1.80E-01	4.47E-01	1.11E+00	2.47E+00	5.20E+00	7.54E+00	1.55E+01	2.70E+01
<b>Age</b>															
01-02	951000	53	16.69	5.20E+00	8.47E-01	2.32E-02	2.45E-01	3.82E-01	1.23E+00	3.27E+00	5.83E+00	1.31E+01	1.96E+01	2.70E+01	2.70E+01
03-05	1235000	76	15.24	2.46E+00	2.79E-01	0.00E+00	4.94E-02	3.94E-01	7.13E-01	1.25E+00	3.91E+00	6.35E+00	7.74E+00	1.06E+01	1.28E+01
06-11	3024000	171	18.10	2.02E+00	2.54E-01	5.95E-03	1.00E-01	1.60E-01	4.00E-01	8.86E-01	2.21E+00	4.64E+00	6.16E+00	1.76E+01	2.36E+01
12-19	3293000	183	16.07	1.48E+00	1.35E-01	0.00E+00	6.46E-02	1.45E-01	3.22E-01	8.09E-01	1.83E+00	3.71E+00	6.03E+00	7.71E+00	9.04E+00
20-39	8593000	437	13.95	1.47E+00	9.59E-02	1.69E-02	7.77E-02	1.57E-01	2.73E-01	7.61E-01	1.91E+00	3.44E+00	4.92E+00	1.05E+01	2.06E+01
40-69	12828000	700	22.62	2.07E+00	1.02E-01	5.13E-03	1.19E-01	2.14E-01	5.26E-01	1.18E+00	2.47E+00	5.12E+00	6.94E+00	1.49E+01	2.29E+01
70 +	4002000	211	25.20	2.51E+00	1.94E-01	5.21E-03	1.51E-01	2.39E-01	5.81E-01	1.37E+00	3.69E+00	6.35E+00	8.20E+00	1.25E+01	1.55E+01
<b>Seasons</b>															
Fall	11026000	394	23.13	1.88E+00	1.28E-01	4.98E-02	1.13E-01	1.80E-01	4.13E-01	9.83E-01	2.11E+00	4.88E+00	6.94E+00	1.25E+01	1.89E+01
Spring	6540000	661	14.17	1.36E+00	7.23E-02	2.44E-03	4.47E-02	1.35E-01	3.21E-01	7.04E-01	1.63E+00	3.37E+00	5.21E+00	8.35E+00	2.36E+01
Summer	11081000	375	24.36	2.86E+00	1.93E-01	6.93E-02	1.57E-01	2.24E-01	7.12E-01	1.62E+00	3.44E+00	6.99E+00	9.75E+00	1.87E+01	2.70E+01
Winter	5745000	425	11.79	1.79E+00	1.14E-01	3.73E-03	4.49E-02	1.56E-01	4.69E-01	1.05E+00	2.27E+00	3.85E+00	6.01E+00	1.06E+01	2.06E+01
<b>Urbanizations</b>															
Central City	6183000	228	10.97	1.40E+00	1.23E-01	1.01E-02	6.59E-02	1.50E-01	3.00E-01	7.50E-01	1.67E+00	3.83E+00	4.67E+00	9.96E+00	1.66E+01
Nonmetropolitan	13808000	878	30.67	2.68E+00	1.19E-01	2.12E-02	1.58E-01	2.58E-01	5.99E-01	1.45E+00	3.27E+00	6.35E+00	9.33E+00	1.75E+01	2.70E+01
Suburban	14341000	747	16.56	1.82E+00	9.12E-02	3.34E-03	1.10E-01	1.63E-01	3.94E-01	9.63E-01	2.18E+00	4.32E+00	6.78E+00	1.25E+01	2.06E+01
<b>Race</b>															
Black	1872000	111	8.61	1.78E+00	2.33E-01	0.00E+00	7.77E-02	1.39E-01	4.38E-01	9.32E-01	2.06E+00	4.68E+00	5.70E+00	8.20E+00	1.89E+01
White	31917000	1714	20.26	2.10E+00	7.09E-02	7.34E-03	1.13E-01	1.84E-01	4.54E-01	1.12E+00	2.48E+00	5.18E+00	7.68E+00	1.55E+01	2.70E+01
<b>Response to Questionnaire</b>															
Households who garden	30217000	1643	44.34	2.17E+00	7.09E-02	5.21E-03	1.11E-01	1.85E-01	4.84E-01	1.18E+00	2.68E+00	5.35E+00	7.72E+00	1.55E+01	2.36E+01
Households who farm	4319000	262	58.93	3.29E+00	2.51E-01	0.00E+00	1.61E-01	2.92E-01	8.46E-01	1.67E+00	3.61E+00	8.88E+00	1.18E+01	1.76E+01	2.36E+01

NOTE: SE = standard error  
 P = percentile of the distribution  
 Nc wgted = weighted number of consumers; Nc unwtgd = unweighted number of consumers in survey.  
 Source: Based on EPA's analyses of the 1987-88 NFCS



Table 13-14. Consumer Only Intake of Homegrown Vegetables (g/kg-day) - Northeast

Population Group	Nc wgted	Nc unwtgd	% Consuming	Mean	SE	P1	P5	P10	P25	P50	P75	P90	P95	P99	P100
Total	4883000	236	11.86	1.78E+00	1.68E-01	2.18E-03	8.27E-02	1.43E-01	2.80E-01	7.47E-01	1.89E+00	6.03E+00	7.82E+00	1.27E+01	1.49E+01
Seasons															
Fall	1396000	41	14.87	1.49E+00	4.06E-01	8.27E-02	1.34E-01	1.74E-01	2.69E-01	5.81E-01	1.17E+00	6.64E+00	9.97E+00	1.02E+01	1.02E+01
Spring	1204000	102	11.43	8.18E-01	1.07E-01	0.00E+00	2.89E-03	4.47E-02	1.72E-01	4.55E-01	9.52E-01	2.26E+00	3.11E+00	6.52E+00	6.78E+00
Summer	1544000	48	16.32	2.83E+00	4.67E-01	1.11E-01	1.45E-01	1.59E-01	7.38E-01	1.29E+00	3.63E+00	7.82E+00	9.75E+00	1.49E+01	1.49E+01
Winter	739000	45	6.27	1.67E+00	2.74E-01	3.23E-03	4.23E-03	9.15E-02	2.56E-01	1.25E+00	2.77E+00	3.63E+00	6.10E+00	8.44E+00	8.44E+00
Urbanizations															
Central City	380000	14	3.93	*	*	*	*	*	*	*	*	*	*	*	*
Nonmetropolitan	787000	48	14.25	3.05E+00	5.41E-01	0.00E+00	4.68E-02	1.14E-01	2.02E-01	2.18E+00	4.61E+00	9.04E+00	1.27E+01	1.49E+01	1.49E+01
Suburban	3716000	174	14.30	1.59E+00	1.74E-01	2.44E-03	8.27E-02	1.42E-01	2.75E-01	7.18E-01	1.64E+00	4.82E+00	6.80E+00	1.02E+01	1.02E+01
Response to Questionnaire															
Households who garden	4381000	211	35.05	1.92E+00	1.84E-01	2.18E-03	8.27E-02	1.42E-01	3.10E-01	8.83E-01	2.18E+00	6.16E+00	7.82E+00	1.27E+01	1.49E+01
Households who farm	352000	19	42.41	*	*	*	*	*	*	*	*	*	*	*	*

\* Intake data not provided for subpopulations for which there were less than 20 observations  
 NOTE: SE = standard error  
 P = percentile of the distribution  
 Nc wgted = weighted number of consumers; Nc unwtgd = unweighted number of consumers in survey.  
 Source: Based on EPA's analyses of the 1987-88 NFCS

Table 13-15. Consumer Only Intake of Homegrown Vegetables (g/kg-day) - Midwest

Population Group	Nc wgted	Nc unwtgd	% Consuming	Mean	SE	P1	P5	P10	P25	P50	P75	P90	P95	P99	P100
Total	12160000	699	26.21	2.26E+00	1.20E-01	1.59E-02	7.77E-02	1.80E-01	4.88E-01	1.15E+00	2.58E+00	5.64E+00	7.74E+00	1.75E+01	2.36E+01
Seasons															
Fall	4914000	180	34.13	1.84E+00	1.76E-01	1.01E-02	6.51E-02	1.60E-01	4.16E-01	1.03E+00	2.10E+00	5.27E+00	6.88E+00	1.31E+01	1.31E+01
Spring	2048000	246	19.22	1.65E+00	1.49E-01	6.04E-02	1.53E-01	2.21E-01	4.59E-01	9.13E-01	1.72E+00	4.49E+00	5.83E+00	1.28E+01	2.36E+01
Summer	3319000	115	32.45	3.38E+00	3.87E-01	1.05E-01	1.62E-01	3.02E-01	8.47E-01	2.07E+00	3.94E+00	7.72E+00	1.40E+01	1.96E+01	2.29E+01
Winter	1879000	158	16.91	2.05E+00	2.64E-01	2.41E-03	2.14E-02	6.59E-02	3.62E-01	8.77E-01	2.13E+00	5.32E+00	7.83E+00	1.67E+01	2.06E+01
Urbanizations															
Central City	3177000	113	18.26	1.36E+00	1.91E-01	0.00E+00	6.05E-02	1.10E-01	2.45E-01	7.13E-01	1.67E+00	3.94E+00	5.50E+00	9.96E+00	1.66E+01
Nonmetropolitan	5344000	379	37.38	2.73E+00	1.86E-01	2.12E-02	1.13E-01	2.61E-01	5.98E-01	1.31E+00	3.15E+00	7.19E+00	1.06E+01	1.75E+01	2.36E+01
Suburban	3639000	207	24.75	2.35E+00	2.16E-01	3.26E-02	1.54E-01	2.22E-01	6.36E-01	1.39E+00	2.75E+00	4.87E+00	7.18E+00	1.96E+01	2.06E+01
Response to Questionnaire															
Households who garden	10927000	632	48.89	2.33E+00	1.27E-01	1.59E-02	1.04E-01	1.76E-01	5.03E-01	1.18E+00	2.74E+00	5.81E+00	7.75E+00	1.67E+01	2.36E+01
Households who farm	1401000	104	52.26	3.97E+00	4.31E-01	1.40E-01	3.35E-01	5.51E-01	8.67E-01	2.18E+00	5.24E+00	1.06E+01	1.44E+01	1.75E+01	2.36E+01

NOTE: SE = standard error  
 P = percentile of the distribution  
 Nc wgted = weighted number of consumers; Nc unwtgd = unweighted number of consumers in survey.  
 Source: Based on EPA's analyses of the 1987-88 NFCS



Table 13-16. Consumer Only Intake of Homegrown Vegetables (g/kg-day) - South

Population Group	Nc wgted	Nc unwtgd	% Consuming	Mean	SE	P1	P5	P10	P25	P50	P75	P90	P95	P99	P100
Total	11254000	618	17.49	2.19E+00	1.21E-01	2.92E-02	1.60E-01	2.41E-01	5.63E-01	1.24E+00	2.69E+00	4.92E+00	7.43E+00	1.70E+01	2.70E+01
Seasons															
Fall	2875000	101	21.80	2.07E+00	2.82E-01	9.59E-02	1.13E-01	1.91E-01	5.24E-01	1.14E+00	2.69E+00	4.48E+00	6.02E+00	1.55E+01	1.89E+01
Spring	2096000	214	12.47	1.55E+00	1.13E-01	1.41E-02	9.21E-02	2.61E-01	5.33E-01	9.35E-01	2.07E+00	3.58E+00	4.81E+00	8.35E+00	1.03E+01
Summer	4273000	151	24.07	2.73E+00	3.16E-01	1.10E-01	1.72E-01	2.50E-01	6.15E-01	1.54E+00	3.15E+00	5.99E+00	9.70E+00	2.36E+01	2.70E+01
Winter	2010000	152	12.12	1.88E+00	1.37E-01	3.03E-03	1.63E-01	3.53E-01	6.40E-01	1.37E+00	2.69E+00	3.79E+00	5.35E+00	7.47E+00	8.36E+00
Urbanizations															
Central City	1144000	45	6.63	1.10E+00	1.62E-01	1.10E-02	9.59E-02	1.50E-01	2.63E-01	6.15E-01	1.37E+00	2.79E+00	3.70E+00	4.21E+00	4.58E+00
Nonmetropolitan	6565000	386	34.37	2.78E+00	1.84E-01	5.08E-02	2.23E-01	3.50E-01	7.12E-01	1.66E+00	3.31E+00	5.99E+00	9.56E+00	1.89E+01	2.70E+01
Suburban	3545000	187	12.67	1.44E+00	1.13E-01	0.00E+00	1.13E-01	1.99E-01	3.96E-01	9.33E-01	1.72E+00	3.61E+00	5.26E+00	8.20E+00	8.20E+00
Response to Questionnaire															
Households who garden	9447000	522	46.04	2.27E+00	1.22E-01	3.46E-02	1.61E-01	2.62E-01	6.10E-01	1.37E+00	3.02E+00	5.18E+00	7.43E+00	1.55E+01	2.36E+01
Households who farm	1609000	91	72.09	3.34E+00	4.57E-01	0.00E+00	1.32E-01	2.33E-01	1.03E+00	1.72E+00	3.15E+00	9.56E+00	1.18E+01	2.36E+01	2.36E+01

NOTE: SE = standard error  
P = percentile of the distribution  
Nc wgted = weighted number of consumers; Nc unwtgd = unweighted number of consumers in survey.  
Source: Based on EPA's analyses of the 1987-88 NFCS

Table 13-17. Consumer Only Intake of Homegrown Vegetables (g/kg-day) - West

Population Group	Nc wgted	Nc unwtgd	% Consuming	Mean	SE	P1	P5	P10	P25	P50	P75	P90	P95	P99	P100
Total	6035000	300	16.73	1.81E+00	1.38E-01	7.35E-03	9.85E-02	1.66E-01	3.79E-01	9.01E-01	2.21E+00	4.64E+00	6.21E+00	1.14E+01	1.55E+01
Seasons															
Fall	1841000	72	17.21	2.01E+00	2.93E-01	9.83E-02	1.50E-01	2.04E-01	4.81E-01	1.21E+00	2.21E+00	4.85E+00	7.72E+00	1.25E+01	1.25E+01
Spring	1192000	99	14.61	1.06E+00	1.74E-01	3.31E-03	7.35E-03	4.66E-02	1.95E-01	3.56E-01	9.08E-01	3.37E+00	5.54E+00	8.60E+00	8.60E+00
Summer	1885000	59	23.60	2.39E+00	3.71E-01	6.93E-02	1.04E-01	2.46E-01	5.45E-01	1.37E+00	3.23E+00	4.67E+00	8.36E+00	1.55E+01	1.55E+01
Winter	1117000	70	12.11	1.28E+00	1.72E-01	1.29E-02	1.52E-01	1.99E-01	4.83E-01	7.65E-01	1.43E+00	2.81E+00	5.12E+00	7.57E+00	7.98E+00
Urbanizations															
Central City	1482000	56	12.31	1.80E+00	2.76E-01	2.58E-02	7.39E-02	1.57E-01	4.81E-01	1.10E+00	2.95E+00	4.64E+00	4.85E+00	1.14E+01	1.14E+01
Nonmetropolitan	1112000	65	18.21	1.52E+00	2.24E-01	3.42E-03	9.80E-03	2.04E-01	2.69E-01	6.75E-01	2.13E+00	4.13E+00	5.12E+00	8.16E+00	8.16E+00
Suburban	3441000	179	19.20	1.90E+00	1.98E-01	1.29E-02	1.04E-01	1.52E-01	3.94E-01	9.32E-01	2.20E+00	4.63E+00	7.98E+00	1.25E+01	1.55E+01
Response to Questionnaire															
Households who garden	5402000	276	42.45	1.91E+00	1.04E-03	8.53E-03	1.04E-01	1.66E-01	4.33E-01	1.07E+00	2.37E+00	4.67E+00	6.21E+00	1.25E+01	1.55E+01
Households who farm	957000	48	60.34	2.73E+00	3.32E-03	1.17E-01	4.14E-01	4.69E-01	7.65E-01	1.42E+00	3.27E+00	6.94E+00	1.09E+01	1.55E+01	1.55E+01

NOTE: SE = standard error  
P = percentile of the distribution  
Nc wgted = weighted number of consumers; Nc unwtgd = unweighted number of consumers in survey.  
Source: Based on EPA's analyses of the 1987-88 NFCS



Table 13-18. Consumer Only Intake of Home Produced Meats (g/kg-day) - All Regions Combined

Population Group	Nc wgtd	Nc unwtgd	% Consuming	Mean	SE	P1	P5	P10	P25	P50	P75	P90	P95	P99	P100
Total	9257000	569	4.92	2.21E+00	1.07E-01	1.21E-01	2.37E-01	3.74E-01	6.60E-01	1.39E+00	2.89E+00	4.89E+00	6.78E+00	1.40E+01	2.32E+01
<b>Age</b>															
01-02	276000	22	4.84	3.65E+00	6.10E-01	3.85E-01	9.49E-01	9.49E-01	1.19E+00	2.66E+00	4.72E+00	8.68E+00	1.00E+01	1.15E+01	1.15E+01
03-05	396000	26	4.89	3.61E+00	5.09E-01	8.01E-01	8.01E-01	1.51E+00	2.17E+00	2.82E+00	3.72E+00	7.84E+00	9.13E+00	1.30E+01	1.30E+01
06-11	1064000	65	6.37	3.65E+00	4.51E-01	3.72E-01	6.52E-01	7.21E-01	1.28E+00	2.09E+00	4.71E+00	8.00E+00	1.40E+01	1.53E+01	1.53E+01
12-19	1272000	78	6.21	1.70E+00	1.68E-01	1.90E-01	3.20E-01	4.70E-01	6.23E-01	1.23E+00	2.35E+00	3.66E+00	4.34E+00	6.78E+00	7.51E+00
20-39	2732000	158	4.43	1.82E+00	1.53E-01	1.23E-01	1.85E-01	2.95E-01	5.28E-01	1.11E+00	2.65E+00	4.52E+00	6.23E+00	9.17E+00	1.09E+01
40-69	2872000	179	5.06	1.72E+00	1.11E-01	1.81E-02	2.12E-01	3.43E-01	5.84E-01	1.17E+00	2.38E+00	3.67E+00	5.16E+00	5.90E+00	7.46E+00
70 +	441000	28	2.78	1.39E+00	2.34E-01	9.26E-02	9.26E-02	1.25E-01	5.47E-01	1.01E+00	1.81E+00	2.82E+00	3.48E+00	7.41E+00	7.41E+00
<b>Seasons</b>															
Fall	2852000	107	5.98	1.57E+00	1.39E-01	1.23E-01	2.10E-01	3.52E-01	5.21E-01	1.11E+00	2.27E+00	3.19E+00	4.41E+00	6.78E+00	7.84E+00
Spring	1726000	197	3.74	2.37E+00	1.52E-01	2.44E-01	3.20E-01	4.46E-01	7.76E-01	1.69E+00	3.48E+00	5.00E+00	6.67E+00	1.01E+01	1.30E+01
Summer	2368000	89	5.21	3.10E+00	3.82E-01	1.81E-02	1.85E-01	4.06E-01	8.52E-01	1.77E+00	4.34E+00	7.01E+00	1.05E+01	2.23E+01	2.23E+01
Winter	2311000	176	4.74	1.98E+00	1.74E-01	1.35E-01	2.37E-01	3.67E-01	6.48E-01	1.33E+00	2.43E+00	3.96E+00	6.40E+00	1.09E+01	2.32E+01
<b>Urbanizations</b>															
Central City	736000	28	1.31	1.15E+00	1.83E-01	1.82E-01	1.85E-01	2.10E-01	4.42E-01	7.21E-01	1.58E+00	2.69E+00	3.40E+00	3.64E+00	3.64E+00
Nonmetropolitan	4932000	315	10.95	2.70E+00	1.76E-01	1.23E-01	2.63E-01	4.06E-01	7.49E-01	1.63E+00	3.41E+00	6.06E+00	8.47E+00	1.53E+01	2.32E+01
Suburban	3589000	226	4.15	1.77E+00	1.03E-01	2.90E-02	2.87E-01	3.67E-01	6.80E-01	1.33E+00	2.49E+00	3.66E+00	4.71E+00	7.20E+00	1.01E+01
<b>Race</b>															
Black	128000	6	0.59	*		*	*	*	*	*	*	*	*	*	*
White	8995000	556	5.71	2.26E+00	1.09E-01	9.26E-02	2.57E-01	3.86E-01	6.80E-01	1.41E+00	2.91E+00	5.00E+00	7.01E+00	1.40E+01	2.32E+01
<b>Response to Questionnaire</b>															
Households who raise animals	5256000	343	52.06	2.80E+00	1.45E-01	2.12E-01	3.86E-01	6.23E-01	1.03E+00	1.94E+00	3.49E+00	5.90E+00	7.84E+00	1.40E+01	2.32E+01
Households who farm	3842000	243	52.42	2.86E+00	1.85E-01	1.97E-01	4.45E-01	5.98E-01	8.94E-01	1.84E+00	3.64E+00	6.09E+00	8.00E+00	1.40E+01	2.32E+01

\* Intake data not provided for subpopulations for which there were less than 20 observations

NOTE: SE = standard error  
P = percentile of the distribution  
Nc wgtd = weighted number of consumers; Nc unwtgd = unweighted number of consumers in survey.  
Source: Based on EPA's analyses of the 1987-88 NFCS



Table 13-19. Consumer Only Intake of Home Produced Meats (g/kg-day) - Northeast

Population Group	Nc wgt'd	Nc unwt'd	% Consuming	Mean	SE	P1	P5	P10	P25	P50	P75	P90	P95	P99	P100
Total	1113000	52	2.70	1.46E+00	2.10E-01	2.92E-01	3.40E-01	3.52E-01	6.44E-01	8.94E-01	1.87E+00	2.68E+00	2.89E+00	1.09E+01	1.09E+01
Seasons															
Fall	569000	18	6.06	*	*	*	*	*	*	*	*	*	*	*	*
Spring	66000	8	0.63	*	*	*	*	*	*	*	*	*	*	*	*
Summer	176000	6	1.86	*	*	*	*	*	*	*	*	*	*	*	*
Winter	302000	20	2.56	2.02E+00	5.56E-01	2.92E-01	3.14E-01	4.30E-01	6.19E-01	1.11E+00	2.38E+00	2.93E+00	7.46E+00	1.09E+01	1.09E+01
Urbanizations															
Central City	0	0	0.00												
Nonmetropolitan	391000	17	7.08	*	*	*	*	*	*	*	*	*	*	*	*
Suburban	722000	35	2.78	1.49E+00	1.53E-01	2.92E-01	3.52E-01	4.30E-01	6.80E-01	1.39E+00	2.34E+00	2.68E+00	2.89E+00	3.61E+00	3.61E+00
Response to Questionnaire															
Households who raise animals	509000	25	43.21	2.03E+00	3.85E-01	6.19E-01	6.46E-01	6.46E-01	8.78E-01	1.62E+00	2.38E+00	2.93E+00	7.46E+00	1.09E+01	1.09E+01
Households who farm	373000	15	44.94	*	*	*	*	*	*	*	*	*	*	*	*

\* Intake data not provided for subpopulations for which there were less than 20 observations  
 NOTE: SE = standard error  
 P = percentile of the distribution  
 Nc wgt'd = weighted number of consumers; Nc unwt'd = unweighted number of consumers in survey.  
 Source: Based on EPA's analyses of the 1987-88 NFCS

Table 13-20. Consumer Only Intake of Home Produced Meats (g/kg-day) - Midwest

Population Group	Nc wgt'd	Nc unwt'd	% Consuming	Mean	SE	P1	P5	P10	P25	P50	P75	P90	P95	P99	P100
Total	3974000	266	8.57	2.55E+00	1.81E-01	1.25E-01	2.57E-01	3.85E-01	6.60E-01	1.40E+00	3.39E+00	5.75E+00	7.20E+00	1.53E+01	2.23E+01
Seasons															
Fall	1261000	49	8.76	1.76E+00	2.31E-01	2.10E-01	2.57E-01	3.72E-01	4.95E-01	1.19E+00	2.66E+00	3.49E+00	6.06E+00	6.78E+00	6.78E+00
Spring	940000	116	8.82	2.58E+00	2.24E-01	2.44E-01	3.11E-01	4.08E-01	7.33E-01	1.98E+00	3.67E+00	5.14E+00	7.79E+00	1.15E+01	1.30E+01
Summer	930000	38	9.09	4.10E+00	7.45E-01	9.26E-02	1.25E-01	5.78E-01	8.93E-01	2.87E+00	5.42E+00	8.93E+00	1.53E+01	2.23E+01	2.23E+01
Winter	843000	63	7.59	2.00E+00	2.41E-01	1.21E-01	2.37E-01	3.28E-01	6.48E-01	1.36E+00	2.69E+00	4.11E+00	5.30E+00	8.10E+00	1.22E+01
Urbanizations															
Central City	460000	18	2.64	*	*	*	*	*	*	*	*	*	*	*	*
Nonmetropolitan	2477000	175	17.33	3.15E+00	2.58E-01	9.26E-02	2.95E-01	4.25E-01	8.16E-01	2.38E+00	4.34E+00	6.15E+00	9.17E+00	1.53E+01	2.23E+01
Suburban	1037000	73	7.05	1.75E+00	1.99E-01	2.87E-01	3.65E-01	4.08E-01	6.60E-01	1.11E+00	2.03E+00	4.16E+00	5.39E+00	7.20E+00	1.01E+01
Response to Questionnaire															
Households who raise animals	2165000	165	57.86	3.20E+00	2.23E-01	2.56E-01	3.86E-01	5.78E-01	1.07E+00	2.56E+00	4.42E+00	6.06E+00	9.13E+00	1.53E+01	1.53E+01
Households who farm	1483000	108	55.32	3.32E+00	2.91E-01	3.65E-01	5.43E-01	5.89E-01	1.07E+00	2.75E+00	4.71E+00	6.78E+00	9.17E+00	1.53E+01	1.53E+01

\* Intake data not provided for subpopulations for which there were less than 20 observations  
 NOTE: SE = standard error  
 P = percentile of the distribution  
 Nc wgt'd = weighted number of consumers; Nc unwt'd = unweighted number of consumers in survey.  
 Source: Based on EPA's analyses of the 1987-88 NFCS



Table 13-21. Consumer Only Intake of Home Produced Meats (g/kg-day) - South

Population Group	Nc wgtd	Nc unwtgd	% Consuming	Mean	SE	P1	P5	P10	P25	P50	P75	P90	P95	P99	P100
Total	2355000	146	3.66	2.24E+00	1.94E-01	1.81E-02	1.56E-01	2.97E-01	7.21E-01	1.53E+00	3.07E+00	5.07E+00	6.71E+00	1.40E+01	1.40E+01
Seasons															
Fall	758000	28	5.75	1.81E+00	2.87E-01	1.23E-01	1.56E-01	1.90E-01	8.19E-01	1.53E+00	2.38E+00	3.19E+00	4.41E+00	7.84E+00	7.84E+00
Spring	511000	53	3.04	2.33E+00	2.66E-01	1.93E-01	2.97E-01	4.99E-01	7.52E-01	1.80E+00	2.82E+00	5.16E+00	6.71E+00	7.51E+00	7.51E+00
Summer	522000	18	2.94	*	*	*	*	*	*	*	*	*	*	*	*
Winter	564000	47	3.40	1.80E+00	2.45E-01	3.70E-02	1.97E-01	2.51E-01	7.16E-01	1.40E+00	2.17E+00	3.55E+00	4.58E+00	8.47E+00	8.47E+00
Urbanizations															
Central City	40000	1	0.23	*	*	*	*	*	*	*	*	*	*	*	*
Nonmetropolitan	1687000	97	8.83	2.45E+00	2.59E-01	1.23E-01	1.90E-01	4.02E-01	7.77E-01	1.61E+00	3.19E+00	6.09E+00	7.84E+00	1.40E+01	1.40E+01
Suburban	628000	48	2.24	1.79E+00	2.30E-01	1.81E-02	2.90E-02	3.70E-02	6.28E-01	1.40E+00	2.31E+00	4.56E+00	4.61E+00	6.40E+00	6.40E+00
Response to Questionnaire															
Households who raise animals	1222000	74	46.95	3.16E+00	3.16E-01	2.63E-01	6.67E-01	8.35E-01	1.34E+00	2.11E+00	3.79E+00	6.67E+00	8.47E+00	1.40E+01	1.40E+01
Households who farm	1228000	72	55.02	2.85E+00	3.24E-01	1.95E-01	4.99E-01	5.98E-01	1.01E+00	1.93E+00	3.48E+00	6.23E+00	8.47E+00	1.40E+01	1.40E+01
* Intake data not provided for subpopulations for which there were less than 20 observations															
NOTE: SE = standard error P = percentile of the distribution Nc wgtd = weighted number of consumers; Nc unwtgd = unweighted number of consumers in survey. Source: Based on EPA's analyses of the 1987-88 NFCS															

Table 13-22. Consumer Only Intake of Home Produced Meats (g/kg-day) - West

Population Group	Nc wgtd	Nc unwtgd	% Consuming	Mean	SE	P1	P5	P10	P25	P50	P75	P90	P95	P99	P100
Total	1815000	105	5.03	1.89E+00	2.12E-01	1.52E-01	2.25E-01	3.90E-01	6.58E-01	1.42E+00	2.49E+00	3.66E+00	4.71E+00	8.00E+00	2.32E+01
Seasons															
Fall	264000	12	2.47	*	*	*	*	*	*	*	*	*	*	*	*
Spring	209000	20	2.56	1.86E+00	2.27E-01	2.99E-01	4.25E-01	8.70E-01	1.22E+00	1.56E+00	2.43E+00	3.48E+00	4.20E+00	4.20E+00	4.20E+00
Summer	740000	27	9.27	2.20E+00	3.18E-01	1.85E-01	4.06E-01	5.35E-01	1.07E+00	1.69E+00	3.27E+00	4.44E+00	4.71E+00	8.00E+00	8.00E+00
Winter	602000	46	6.53	2.11E+00	4.55E-01	1.35E-01	3.56E-01	4.28E-01	6.72E-01	1.19E+00	2.35E+00	3.64E+00	7.02E+00	2.32E+01	2.32E+01
Urbanizations															
Central City	236000	9	1.96	*	*	*	*	*	*	*	*	*	*	*	*
Nonmetropolitan	377000	26	6.17	2.10E+00	7.00E-01	3.30E-01	3.30E-01	4.06E-01	6.72E-01	1.19E+00	1.77E+00	3.72E+00	4.97E+00	2.32E+01	2.32E+01
Suburban	1202000	70	6.71	1.95E+00	1.99E-01	1.52E-01	2.25E-01	3.67E-01	7.80E-01	1.52E+00	2.71E+00	4.20E+00	4.71E+00	8.00E+00	8.00E+00
Response to Questionnaire															
Households who raise animals	1360000	79	52.84	2.12E+00	2.65E-01	1.52E-01	2.25E-01	3.90E-01	8.15E-01	1.56E+00	2.71E+00	4.20E+00	4.97E+00	8.00E+00	2.32E+01
Households who farm	758000	48	47.79	2.41E+00	4.26E-01	1.35E-01	3.30E-01	4.67E-01	7.85E-01	1.55E+00	2.91E+00	4.71E+00	7.02E+00	2.32E+01	2.32E+01
* Intake data not provided for subpopulations for which there were less than 20 observations															
NOTE: SE = standard error P = percentile of the distribution Nc wgtd = weighted number of consumers; Nc unwtgd = unweighted number of consumers in survey. Source: Based on EPA's analyses of the 1987-88 NFCS															



Table 13-23. Consumer Only Intake of Home Caught Fish (g/kg-day) - All Regions Combined

Population Group	Nc wgtd	Nc unwtgd	% Consuming	Mean	SE	P1	P5	P10	P25	P50	P75	P90	P95	P99	P100
Total	3914000	239	2.08	2.07E+00	2.38E-01	8.16E-02	9.11E-02	1.95E-01	2.28E-01	4.31E-01	9.97E-01	2.17E+00	4.68E+00	7.83E+00	1.55E+01
<b>Age</b>															
01-02	82000	6	1.44	*	*	*	*	*	*	*	*	*	*	*	*
03-05	142000	11	1.75	*	*	*	*	*	*	*	*	*	*	*	*
06-11	382000	29	2.29	2.78E+00	8.40E-01	1.60E-01	1.60E-01	1.84E-01	2.28E-01	5.47E-01	1.03E+00	3.67E+00	7.05E+00	7.85E+00	2.53E+01
12-19	346000	21	1.69	1.52E+00	4.07E-01	1.95E-01	1.95E-01	1.95E-01	1.95E-01	3.11E-01	9.84E-01	1.79E+00	4.68E+00	6.67E+00	8.44E+00
20-39	962000	59	1.56	1.91E+00	3.34E-01	8.16E-02	8.16E-02	9.11E-02	1.18E-01	4.43E-01	1.06E+00	2.18E+00	4.46E+00	9.57E+00	1.30E+01
40-69	1524000	86	2.69	1.79E+00	2.56E-01	9.47E-02	9.47E-02	2.10E-01	2.75E-01	3.45E-01	9.85E-01	1.99E+00	4.43E+00	6.56E+00	1.08E+01
70 +	450000	24	2.83	1.22E+00	2.30E-01	9.88E-02	9.88E-02	2.33E-01	2.33E-01	5.68E-01	7.64E-01	1.56E+00	3.73E+00	3.73E+00	5.12E+00
<b>Season</b>															
Fall	1220000	45	2.56	1.31E+00	2.16E-01	1.84E-01	1.84E-01	1.96E-01	2.10E-01	3.18E-01	9.16E-01	1.79E+00	2.64E+00	3.73E+00	6.56E+00
Spring	1112000	114	2.41	3.08E+00	5.55E-01	9.88E-02	1.16E-01	3.08E-01	3.40E-01	5.59E-01	1.27E+00	2.64E+00	6.68E+00	1.08E+01	3.73E+01
Summer	911000	29	2.00	1.88E+00	4.24E-01	8.16E-02	8.16E-02	9.11E-02	2.04E-01	3.01E-01	7.64E-01	3.19E+00	4.43E+00	5.65E+00	9.57E+00
Winter	671000	51	1.38	2.05E+00	3.68E-01	9.47E-02	9.47E-02	1.11E-01	1.60E-01	5.10E-01	1.06E+00	2.09E+00	5.89E+00	7.85E+00	1.31E+01
<b>Urbanization</b>															
Central City	999000	46	1.77	1.79E+00	3.40E-01	9.47E-02	9.47E-02	1.60E-01	2.84E-01	6.08E-01	1.07E+00	1.85E+00	3.73E+00	9.57E+00	9.57E+00
Nonmetropolitan	1174000	94	2.61	3.15E+00	5.74E-01	9.88E-02	1.16E-01	3.10E-01	3.62E-01	5.68E-01	1.88E+00	3.86E+00	6.52E+00	7.83E+00	3.73E+01
Suburban	1741000	99	2.01	1.50E+00	2.30E-01	8.16E-02	8.16E-02	1.84E-01	2.01E-01	2.86E-01	5.87E-01	1.38E+00	4.37E+00	7.05E+00	1.08E+01
<b>Race</b>															
Black	593000	41	2.73	1.81E+00	3.74E-01	1.84E-01	1.84E-01	2.01E-01	2.86E-01	3.18E-01	9.84E-01	2.17E+00	4.68E+00	9.57E+00	9.57E+00
White	3228000	188	2.05	2.07E+00	2.81E-01	8.16E-02	8.16E-02	1.60E-01	2.27E-01	3.93E-01	9.97E-01	2.16E+00	4.99E+00	6.68E+00	1.61E+01
<b>Response to Questionnaire</b>															
Households who fish	3553000	220	8.94	2.22E+00	2.58E-01	8.16E-02	8.16E-02	1.84E-01	2.27E-01	4.66E-01	1.09E+00	2.23E+00	5.61E+00	7.85E+00	1.61E+01
* Intake data not provided for subpopulations for which there were less than 20 observations															
NOTE: SE = standard error P = percentile of the distribution Nc wgtd = weighted number of consumers; Nc unwtgd = unweighted number of consumers in survey.															
Source: Based on EPA's analyses of the 1987-88 NFCS															





Table 13-24. Consumer Only Intake of Home Caught Fish (g/kg-day) - Northeast

Population Group	Nc wgtd	Nc unwgtd	% Consuming	Mean	SE	P1	P5	P10	P25	P50	P75	P90	P95	P99	P100
Total	334000	12	0.81	*	*	*	*	*	*	*	*	*	*	*	*
Season															
Fall	135000	4	1.44	*	*	*	*	*	*	*	*	*	*	*	*
Spring	14000	2	0.13	*	*	*	*	*	*	*	*	*	*	*	*
Summer	132000	3	1.40	*	*	*	*	*	*	*	*	*	*	*	*
Winter	53000	3	0.45	*	*	*	*	*	*	*	*	*	*	*	*
Urbanization															
Central City		0													
Nonmetropolitan	42000	4	0.76	*	*	*	*	*	*	*	*	*	*	*	*
Suburban	292000	8	1.12	*	*	*	*	*	*	*	*	*	*	*	*
Response to Questionnaire															
Households who fish	334000	12	5.61	*	*	*	*	*	*	*	*	*	*	*	*

\* Intake data not provided for subpopulations for which there were less than 20 observations

NOTE: SE = standard error  
P = percentile of the distribution  
Nc wgtd = weighted number of consumers; Nc unwgtd = unweighted number of consumers in survey.  
Source: Based on EPA's analyses of the 1987-88 NFCS

Table 13-25. Consumer Only Intake of Home Caught Fish (g/kg-day) - Midwest

Population Group	Nc wgtd	Nc unwgtd	% Consuming	Mean	SE	P1	P5	P10	P25	P50	P75	P90	P95	P99	P100
Total	1113000	71	2.40	2.13E+00	4.19E-01	8.16E-02	8.16E-02	1.96E-01	2.27E-01	4.71E-01	1.03E+00	1.95E+00	6.10E+00	6.56E+00	1.61E+01
Season															
Fall	362000	13	2.51	*	*	*	*	*	*	*	*	*	*	*	*
Spring	224000	27	2.10	3.45E+00	1.22E+00	1.16E-01	1.16E-01	1.18E-01	3.10E-01	4.87E-01	8.21E-01	1.67E+00	1.55E+01	1.61E+01	2.53E+01
Summer	264000	8	2.58	*	*	*	*	*	*	*	*	*	*	*	*
Winter	263000	23	2.37	2.38E+00	5.33E-01	5.10E-01	5.10E-01	5.10E-01	5.48E-01	1.03E+00	1.56E+00	2.13E+00	5.89E+00	6.10E+00	1.31E+01
Urbanization															
Central City	190000	9	1.09	*	*	*	*	*	*	*	*	*	*	*	*
Nonmetropolitan	501000	40	3.50	3.42E+00	7.17E-01	1.16E-01	1.16E-01	3.30E-01	4.66E-01	5.33E-01	1.88E+00	5.65E+00	6.56E+00	1.31E+01	2.53E+01
Suburban	422000	22	2.87	9.09E-01	1.81E-01	8.16E-02	8.16E-02	8.16E-02	1.96E-01	3.01E-01	5.48E-01	1.28E+00	2.09E+00	2.78E+00	3.73E+00
Response to Questionnaire															
Households who fish	956000	60	7.57	2.35E+00	4.85E-01	8.16E-02	8.16E-02	1.18E-01	2.27E-01	4.66E-01	1.12E+00	2.16E+00	6.52E+00	6.56E+00	2.53E+01

\* Intake data not provided for subpopulations for which there were less than 20 observations

NOTE: SE = standard error  
P = percentile of the distribution  
Nc wgtd = weighted number of consumers; Nc unwgtd = unweighted number of consumers in survey.  
Source: Based on EPA's analyses of the 1987-88 NFCS



Table 13-26. Consumer Only Intake of Home Caught Fish (g/kg-day) - South

Population Group	Nc wgt'd	Nc unwt'd	% Consuming	Mean	SE	P1	P5	P10	P25	P50	P75	P90	P95	P99	P100
Total	1440000	101	2.24	2.74E+00	4.76E-01	9.47E-02	9.47E-02	2.04E-01	2.86E-01	5.07E-01	1.48E+00	3.37E+00	5.61E+00	8.44E+00	3.73E+01
Season															
Fall	274000	11	2.08	*	*	*	*	*	*	*	*	*	*	*	*
Spring	538000	58	3.20	4.00E+00	9.42E-01	3.08E-01	3.08E-01	3.87E-01	4.46E-01	8.74E-01	1.94E+00	3.71E+00	8.33E+00	1.30E+01	4.52E+01
Summer	376000	14	2.12	*	*	*	*	*	*	*	*	*	*	*	*
Winter	252000	18	1.52	*	*	*	*	*	*	*	*	*	*	*	*
Urbanization															
Central City	281000	16	1.63	*	*	*	*	*	*	*	*	*	*	*	*
Nonmetropolitan	550000	41	2.88	3.33E+00	1.06E+00	2.85E-01	2.85E-01	3.38E-01	5.07E-01	1.12E+00	1.94E+00	3.19E+00	4.43E+00	6.67E+00	4.52E+01
Suburban	609000	44	2.18	2.73E+00	4.98E-01	2.04E-01	2.04E-01	2.75E-01	2.86E-01	4.26E-01	1.08E+00	4.37E+00	8.33E+00	1.04E+01	1.30E+01
Response to Questionnaire															
Households who fish	1280000	95	9.42	3.00E+00	5.14E-01	9.47E-02	9.47E-02	2.04E-01	2.80E-01	7.06E-01	1.93E+00	3.67E+00	6.68E+00	8.44E+00	3.73E+01

\* Intake data not provided for subpopulations for which there were less than 20 observations

NOTE: SE = standard error  
P = percentile of the distribution  
Nc wgt'd = weighted number of consumers; Nc unwt'd = unweighted number of consumers in survey.  
Source: Based on EPA's analyses of the 1987-88 NFCS

Table 13-27. Consumer Only Intake of Home Caught Fish (g/kg-day) - West

Population Group	Nc wgt'd	Nc unwt'd	% Consuming	Mean	SE	P1	P5	P10	P25	P50	P75	P90	P95	P99	P100
Total	1027000	55	2.85	1.57E+00	2.72E-01	9.88E-02	1.60E-01	2.01E-01	2.38E-01	4.43E-01	8.38E-01	1.79E+00	3.73E+00	5.67E+00	9.57E+00
Season															
Fall	449000	17	4.20	*	*	*	*	*	*	*	*	*	*	*	*
Spring	336000	27	4.12	1.35E+00	2.94E-01	9.88E-02	9.88E-02	2.38E-01	3.27E-01	4.43E-01	6.08E-01	1.68E+00	4.68E+00	5.61E+00	5.67E+00
Summer	139000	4	1.74	*	*	*	*	*	*	*	*	*	*	*	*
Winter	103000	7	1.12	*	*	*	*	*	*	*	*	*	*	*	*
Urbanization															
Central City	528000	21	4.38	2.03E+00	5.25E-01	3.27E-01	3.27E-01	4.33E-01	5.29E-01	7.12E-01	1.45E+00	1.85E+00	3.73E+00	9.57E+00	9.57E+00
Nonmetropolitan	81000	9	1.33	*	*	*	*	*	*	*	*	*	*	*	*
Suburban	418000	25	2.33	1.09E+00	2.49E-01	1.84E-01	1.84E-01	2.01E-01	2.10E-01	3.08E-01	5.87E-01	1.21E+00	2.90E+00	4.68E+00	5.61E+00
Response to Questionnaire															
Households who fish	983000	53	12.99	1.63E+00	2.81E-01	9.88E-02	1.60E-01	2.01E-01	2.18E-01	5.47E-01	9.64E-01	1.79E+00	3.73E+00	5.67E+00	9.57E+00

\* Intake data not provided for subpopulations for which there were less than 20 observations

NOTE: SE = standard error  
P = percentile of the distribution  
Nc wgt'd = weighted number of consumers; Nc unwt'd = unweighted number of consumers in survey.  
Source: Based on EPA's analyses of the 1987-88 NFCS



Table 13-28. Consumer Only Intake of Home Produced Dairy (g/kg-day) - All Regions

Population Group	Nc wgt'd	Nc unwt'd	% Consumin g	Mean	SE	P1	P5	P10	P25	P50	P75	P90	P95	P99	P100
Total	1409000	89	0.75	1.40E+01	1.62E+00	1.80E-01	4.46E-01	5.08E-01	3.18E+00	1.02E+01	1.95E+01	3.42E+01	4.40E+01	7.26E+01	1.11E+02
Age															
01-02	79000	6	1.39	*	*	*	*	*	*	*	*	*	*	*	*
03-05	57000	5	0.70	*	*	*	*	*	*	*	*	*	*	*	*
06-11	264000	16	1.58	*	*	*	*	*	*	*	*	*	*	*	*
12-19	84000	5	0.41	*	*	*	*	*	*	*	*	*	*	*	*
20-39	612000	36	0.99	7.41E+00	1.02E+00	2.05E-01	3.96E-01	4.46E-01	1.89E+00	6.46E+00	1.21E+01	1.54E+01	1.95E+01	2.30E+01	2.30E+01
40-69	216000	16	0.38	*	*	*	*	*	*	*	*	*	*	*	*
70 +	77000	3	0.48	*	*	*	*	*	*	*	*	*	*	*	*
Seasons															
Fall	211000	7	0.44	*	*	*	*	*	*	*	*	*	*	*	*
Spring	253000	27	0.55	1.78E+01	4.27E+00	6.28E-01	6.54E-01	6.72E-01	5.06E+00	1.22E+01	1.95E+01	5.09E+01	8.01E+01	1.11E+02	1.11E+02
Summer	549000	22	1.21	1.53E+01	2.73E+00	4.46E-01	4.46E-01	5.08E-01	5.36E+00	1.06E+01	2.51E+01	3.49E+01	3.67E+01	4.68E+01	4.68E+01
Winter	396000	33	0.81	8.08E+00	1.99E+00	1.80E-01	2.05E-01	2.80E-01	7.36E-01	5.47E+00	1.15E+01	1.98E+01	2.04E+01	7.26E+01	7.26E+01
Urbanizations															
Central City	115000	7	0.20	*	*	*	*	*	*	*	*	*	*	*	*
Nonmetropolitan	988000	59	2.19	1.68E+01	2.10E+00	4.79E-01	9.58E-01	1.89E+00	6.74E+00	1.08E+01	2.04E+01	3.49E+01	4.40E+01	8.01E+01	1.11E+02
Suburban	306000	23	0.35	9.86E+00	2.38E+00	3.96E-01	3.96E-01	4.46E-01	5.71E-01	5.36E+00	1.31E+01	2.81E+01	2.89E+01	5.09E+01	5.09E+01
Race															
Black	0	0	0.00												
White	1382000	86	0.88	1.43E+01	1.65E+00	1.80E-01	4.46E-01	5.08E-01	3.82E+00	1.03E+01	1.95E+01	3.42E+01	4.40E+01	8.01E+01	1.11E+02
Response to Questionnaire															
Households who raise animals	1228000	80	12.16	1.59E+01	1.73E+00	1.80E-01	3.96E-01	1.89E+00	6.13E+00	1.08E+01	1.96E+01	3.49E+01	4.40E+01	8.01E+01	1.11E+02
Households who farm	1020000	63	13.92	1.71E+01	1.99E+00	3.96E-01	7.36E-01	3.18E+00	9.06E+00	1.21E+01	2.04E+01	3.49E+01	4.40E+01	8.01E+01	1.11E+02
* Intake data not provided for subpopulations for which there were less than 20 observations															
NOTE: SE = standard error															
P = percentile of the distribution															
Nc wgt'd = weighted number of consumers; Nc unwt'd = unweighted number of consumers in survey.															
Source: Based on EPA's analyses of the 1987-88 NFCS															



Table 13-29. Consumer Only Intake of Home Produced Dairy (g/kg-day) - Northeast

Population Group	Nc wgted	Nc unwgted	% Consuming	Mean	SE	P1	P5	P10	P25	P50	P75	P90	P95	P99	P100
Total	312000	16	0.76	*	*	*	*	*	*	*	*	*	*	*	*
Seasons															
Fall	48000	2	0.51	*	*	*	*	*	*	*	*	*	*	*	*
Spring	36000	4	0.34	*	*	*	*	*	*	*	*	*	*	*	*
Summer	116000	4	1.23	*	*	*	*	*	*	*	*	*	*	*	*
Winter	112000	6	0.95	*	*	*	*	*	*	*	*	*	*	*	*
Urbanizations															
Central City	0	0	0.00												
Nonmetropolitan	240000	10	4.35	*	*	*	*	*	*	*	*	*	*	*	*
Suburban	72000	6	0.28	*	*	*	*	*	*	*	*	*	*	*	*
Response to Questionnaire															
Households who raise animals	312000	16	26.49	*	*	*	*	*	*	*	*	*	*	*	*
Households who farm	312000	16	37.59	*	*	*	*	*	*	*	*	*	*	*	*

\* Intake data not provided for subpopulations for which there were less than 20 observations

NOTE: SE = standard error  
P = percentile of the distribution  
Nc wgted = weighted number of consumers; Nc unwgted = unweighted number of consumers in survey.  
Source: Based on EPA's analyses of the 1987-88 NFCS

Table 13-30. Consumer Only Intake of Home Produced Dairy (g/kg-day) - Midwest

Population Group	Nc wgted	Nc unwgted	% Consuming	Mean	SE	P1	P5	P10	P25	P50	P75	P90	P95	P99	P100
Total	594000	36	1.28	1.86E+01	3.15E+00	4.46E-01	4.46E-01	1.97E+00	8.27E+00	1.24E+01	2.30E+01	4.40E+01	4.68E+01	1.11E+02	1.11E+02
Seasons															
Fall	163000	5	1.13	*	*	*	*	*	*	*	*	*	*	*	*
Spring	94000	12	0.88	*	*	*	*	*	*	*	*	*	*	*	*
Summer	252000	11	2.46	*	*	*	*	*	*	*	*	*	*	*	*
Winter	85000	8	0.76	*	*	*	*	*	*	*	*	*	*	*	*
Urbanizations															
Central City	43000	1	0.25	*	*	*	*	*	*	*	*	*	*	*	*
Nonmetropolitan	463000	31	3.24	2.33E+01	3.40E+00	4.25E+00	8.27E+00	9.06E+00	1.21E+01	1.60E+01	3.14E+01	4.40E+01	4.68E+01	1.11E+02	1.11E+02
Suburban	88000	4	0.60	*	*	*	*	*	*	*	*	*	*	*	*
Response to Questionnaire															
Households who raise animals	490000	32	13.09	2.23E+01	3.33E+00	4.25E+00	5.36E+00	8.27E+00	1.08E+01	1.54E+01	3.14E+01	4.40E+01	4.68E+01	1.11E+02	1.11E+02
Households who farm	490000	32	18.28	2.23E+01	3.33E+00	4.25E+00	5.36E+00	8.27E+00	1.08E+01	1.54E+01	3.14E+01	4.40E+01	4.68E+01	1.11E+02	1.11E+02

\* Intake data not provided for subpopulations for which there were less than 20 observations

NOTE: SE = standard error  
P = percentile of the distribution  
Nc wgted = weighted number of consumers; Nc unwgted = unweighted number of consumers in survey.  
Source: Based on EPA's analyses of the 1987-88 NFCS



Table 13-31. Consumer Only Intake of Home Produced Dairy (g/kg-day) - South

Population Group	Nc wgtd	Nc unwtgd	% Consuming	Mean	SE	P1	P5	P10	P25	P50	P75	P90	P95	P99	P100
Total	242000	17	0.38	*	*	*	*	*	*	*	*	*	*	*	*
Seasons															
Fall	0	0	0.00												
Spring	27000	3	0.16	*	*	*	*	*	*	*	*	*	*	*	*
Summer	131000	5	0.74	*	*	*	*	*	*	*	*	*	*	*	*
Winter	84000	9	0.51	*	*	*	*	*	*	*	*	*	*	*	*
Urbanizations															
Central City	27000	3	0.16	*	*	*	*	*	*	*	*	*	*	*	*
Nonmetropolitan	215000	14	1.13	*	*	*	*	*	*	*	*	*	*	*	*
Suburban	0	0	0.00												
Response to Questionnaire															
Households who raise animals	215000	14	8.26	*	*	*	*	*	*	*	*	*	*	*	*
Households who farm	148000	8	6.63	*	*	*	*	*	*	*	*	*	*	*	*

\* Intake data not provided for subpopulations for which there were less than 20 observations

NOTE: SE = standard error  
P = percentile of the distribution  
Nc wgtd = weighted number of consumers; Nc unwtgd = unweighted number of consumers in survey.  
Source: Based on EPA's analyses of the 1987-88 NFCS

Table 13-32. Consumer Only Intake of Home Produced Dairy (g/kg-day) - West

Population Group	Nc wgtd	Nc unwtgd	% Consuming	Mean	SE	P1	P5	P10	P25	P50	P75	P90	P95	P99	P100
Total	261000	20	0.72	1.00E+01	2.75E+00	1.80E-01	1.80E-01	2.05E-01	5.08E-01	6.10E+00	1.33E+01	2.81E+01	2.89E+01	5.09E+01	5.09E+01
Seasons															
Fall	0	0	0.00												
Spring	96000	8	1.18	*	*	*	*	*	*	*	*	*	*	*	*
Summer	50000	2	0.63	*	*	*	*	*	*	*	*	*	*	*	*
Winter	115000	10	1.25	*	*	*	*	*	*	*	*	*	*	*	*
Urbanizations															
Central City	45000	3	0.37	*	*	*	*	*	*	*	*	*	*	*	*
Nonmetropolitan	70000	4	1.15	*	*	*	*	*	*	*	*	*	*	*	*
Suburban	146000	13	0.81	*	*	*	*	*	*	*	*	*	*	*	*
Response to Questionnaire															
Households who raise animals	211000	18	8.20	*	*	*	*	*	*	*	*	*	*	*	*
Households who farm	70000	7	4.41	*	*	*	*	*	*	*	*	*	*	*	*

\* Intake data not provided for subpopulations for which there were less than 20 observations

NOTE: SE = standard error  
P = percentile of the distribution  
Nc wgtd = weighted number of consumers; Nc unwtgd = unweighted number of consumers in survey.  
Source: Based on EPA's analyses of the 1987-88 NFCS



Table 13-33. Seasonally Adjusted Consumer Only Homegrown Intake (g/kg-day)

Population Group	Percent Consuming	P1	P5	P10	P25	P50	P75	P90	P95	P99	P100
<u>Total Vegetables</u>											
Northeast	16.50	1.16E-03	1.59E-02	3.56E-02	1.99E-01	4.55E-01	1.37E+00	3.32E+00	5.70E+00	8.78E+00	1.01E+01
Midwest	33.25	3.69E-03	4.11E-02	8.26E-02	2.91E-01	8.11E-01	1.96E+00	4.40E+00	7.41E+00	1.31E+00	2.01E+01
South	24.00	4.78E-03	3.24E-02	5.58E-02	2.05E-01	6.10E-01	1.86E+00	3.95E+00	5.63E+00	1.20E+01	1.62E+01
West	23.75	1.80E-03	1.91E-02	3.83E-02	1.14E-01	4.92E-01	1.46E+00	2.99E+00	5.04E+00	8.91E+00	1.12E+01
All Regions	24.60	5.00E-03	2.90E-02	5.90E-02	2.19E-01	6.38E-01	1.80E+00	4.00E+00	6.08E+00	1.17E+01	2.01E+01
<u>Total Fruit</u>											
Northeast	3.50	3.96E-03	1.97E-02	4.76E-02	1.73E-01	3.61E-01	6.55E-01	1.48E+00	3.00E+00	5.10E+00	5.63E+00
Midwest	12.75	1.22E-03	7.01E-03	1.46E-02	1.36E-01	7.87E-01	2.98E+00	5.79E+00	9.52E+00	2.22E+01	2.71E+01
South	8.00	6.13E-03	3.23E-02	1.09E-01	3.84E-01	9.47E-01	2.10E+00	6.70+00	1.02E+01	1.49E+01	1.64E+01
West	17.75	5.50E-04	5.66E-02	8.82E-02	2.87E-01	6.88E-01	1.81E+00	4.75E+00	8.54E+00	1.45E+01	1.84E+01
All Regions	10.10	2.00E-03	1.90E-02	6.20E-02	2.50E-01	7.52E-01	2.35E+00	5.61E+00	9.12E+00	1.76E+01	2.71E+01
<u>Total Meat</u>											
Northeast	6.25	3.78E-03	3.01E-02	7.94E-02	1.25E-01	2.11E-01	7.00E-01	1.56E+00	1.91E+00	4.09E+00	4.80E+00
Midwest	9.25	1.77E-03	3.68E-02	2.21E-01	5.25E-02	1.61E+00	3.41E+00	5.25E+00	7.45E+00	1.19E+01	1.36E+01
South	5.75	6.12E-03	2.88E-02	5.02E-02	1.86E-01	5.30E-01	1.84E+00	3.78E+00	4.95E+00	8.45E+00	9.45E+00
West	9.50	7.24E-04	2.83E-02	9.56E-02	2.35E-01	5.64E-01	1.30E+00	2.29E+00	3.38E+00	7.20E+00	9.10E+00
All Regions	7.40	3.20E-03	3.90E-02	9.20E-02	2.20E-01	6.55E-01	1.96E+00	4.05E+00	5.17E+00	9.40E+00	1.36E+01



Table 13-34. Consumer Only Intake of Homegrown Apples (g/kg-day)

Population Group	Nc wgtgd	Nc unwtgd	% Consuming	Mean	SE	P1	P5	P10	P25	P50	P75	P90	P95	P99	P100
Total	5306000	272	2.82	1.19E+00	7.58E-02	8.34E-02	2.30E-01	2.84E-01	4.50E-01	8.17E-01	1.47E+00	2.38E+00	3.40E+00	5.42E+00	1.01E+01
<b>Age</b>															
01-02	199000	12	3.49	*	*	*	*	*	*	*	*	*	*	*	*
03-05	291000	16	3.59	*	*	*	*	*	*	*	*	*	*	*	*
06-11	402000	25	2.41	1.28E+00	1.88E-01	4.72E-01	4.72E-01	5.63E-01	7.40E-01	9.56E-01	1.29E+00	2.98E+00	4.00E+00	4.00E+00	4.00E+00
12-19	296000	12	1.44	*	*	*	*	*	*	*	*	*	*	*	*
20-39	1268000	61	2.06	7.95E-01	1.07E-01	1.85E-01	2.30E-01	2.56E-01	3.04E-01	6.02E-01	9.22E-01	1.55E+00	1.97E+00	5.42E+00	5.42E+00
40-69	1719000	90	3.03	9.61E-01	1.37E-01	5.57E-02	8.94E-02	2.55E-01	3.98E-01	6.48E-01	1.08E+00	1.59E+00	2.38E+00	9.83E+00	9.83E+00
70 +	1061000	52	6.68	1.45E+00	1.41E-01	1.99E-01	2.60E-01	4.46E-01	6.27E-01	1.18E+00	1.82E+00	3.40E+00	3.62E+00	4.20E+00	4.20E+00
<b>Season</b>															
Fall	1707000	60	3.58	1.28E+00	1.24E-01	2.56E-01	2.95E-01	3.20E-01	5.83E-01	1.03E+00	1.66E+00	2.69E+00	3.40E+00	4.25E+00	4.25E+00
Spring	639000	74	1.38	9.50E-01	1.14E-01	1.94E-01	2.38E-01	2.84E-01	3.76E-01	5.67E-01	1.10E+00	2.00E+00	2.78E+00	5.87E+00	5.87E+00
Summer	1935000	68	4.25	1.12E+00	1.69E-01	5.57E-02	8.94E-02	1.86E-01	3.98E-01	6.92E-01	1.41E+00	2.29E+00	2.98E+00	9.83E+00	9.83E+00
Winter	1025000	70	2.10	1.30E+00	1.78E-01	1.85E-01	2.30E-01	3.23E-01	5.71E-01	8.81E-01	1.59E+00	2.75E+00	3.40E+00	1.01E+01	1.01E+01
<b>Urbanization</b>															
Central City	912000	30	1.62	1.24E+00	2.60E-01	2.31E-01	2.56E-01	3.92E-01	5.10E-01	9.17E-01	1.59E+00	2.19E+00	2.26E+00	1.01E+01	1.01E+01
Nonmetropolitan	2118000	122	4.70	1.27E+00	1.26E-01	5.57E-02	1.18E-01	2.49E-01	4.11E-01	9.00E-01	1.55E+00	2.92E+00	3.48E+00	9.83E+00	9.83E+00
Suburban	2276000	120	2.63	1.09E+00	9.16E-02	1.86E-01	2.37E-01	2.91E-01	4.37E-01	7.74E-01	1.29E+00	2.29E+00	3.40E+00	5.42E+00	5.42E+00
<b>Race</b>															
Black	84000	4	0.39	*	*	*	*	*	*	*	*	*	*	*	*
White	5222000	268	3.31	1.18E+00	7.67E-02	8.34E-02	2.30E-01	2.79E-01	4.48E-01	7.98E-01	1.41E+00	2.38E+00	3.40E+00	5.42E+00	1.01E+01
<b>Region</b>															
Midwest	2044000	123	4.41	1.38E+00	1.45E-01	2.16E-01	2.85E-01	3.04E-01	5.20E-01	9.23E-01	1.61E+00	2.69E+00	3.40E+00	9.83E+00	1.01E+01
Northeast	442000	18	1.07	*	*	*	*	*	*	*	*	*	*	*	*
South	1310000	65	2.04	1.10E+00	1.07E-01	1.99E-01	2.38E-01	3.01E-01	4.39E-01	9.17E-01	1.38E+00	1.90E+00	2.98E+00	4.00E+00	4.91E+00
West	1510000	66	4.19	1.20E+00	1.29E-01	5.57E-02	1.86E-01	2.64E-01	4.72E-01	7.89E-01	1.82E+00	2.75E+00	3.62E+00	4.25E+00	4.25E+00
<b>Response to Questionnaire</b>															
Households who garden	4707000	246	6.91	1.21E+00	8.22E-02	1.27E-01	2.49E-01	2.95E-01	4.70E-01	8.17E-01	1.47E+00	2.38E+00	3.40E+00	5.87E+00	1.01E+01
Households who farm	1299000	68	17.72	1.39E+00	1.31E-01	5.57E-02	3.57E-01	5.36E-01	7.03E-01	9.56E-01	1.58E+00	2.99E+00	4.00E+00	4.91E+00	5.87E+00
* Intake data not provided for subpopulations for which there were less than 20 observations															
NOTE: SE = standard error P = percentile of the distribution Nc wgtgd = weighted number of consumers; Nc unwtgd = unweighted number of consumers in survey. Source: Based on EPA's analyses of the 1987-88 NFCS															



Table 13-35. Consumer Only Intake of Homegrown Asparagus (g/kg-day)

Population Group	Nc wgt'd	Nc unwt'd	% Consuming	Mean	SE	P1	P5	P10	P25	P50	P75	P90	P95	P99	P100
Total	763000	66	0.41	5.59E-01	5.12E-02	1.00E-01	1.41E-01	1.91E-01	2.75E-01	4.00E-01	7.07E-01	1.12E+00	1.63E+00	1.97E+00	1.97E+00
<b>Age</b>															
01-02	8000	1	0.14	*	*	*	*	*	*	*	*	*	*	*	*
03-05	25000	3	0.31	*	*	*	*	*	*	*	*	*	*	*	*
06-11	31000	3	0.19	*	*	*	*	*	*	*	*	*	*	*	*
12-19	70000	5	0.34	*	*	*	*	*	*	*	*	*	*	*	*
20-39	144000	11	0.23	*	*	*	*	*	*	*	*	*	*	*	*
40-69	430000	38	0.76	4.65E-01	5.38E-02	1.10E-01	1.13E-01	1.81E-01	2.34E-01	4.00E-01	5.96E-01	8.84E-01	1.24E+00	1.75E+00	1.75E+00
70 +	55000	5	0.35	*	*	*	*	*	*	*	*	*	*	*	*
<b>Season</b>															
Fall	62000	2	0.13	*	*	*	*	*	*	*	*	*	*	*	*
Spring	608000	59	1.32	6.12E-01	5.75E-02	1.00E-01	1.57E-01	1.91E-01	2.98E-01	4.46E-01	8.8/4E-01	1.18E+00	1.63E+00	1.97E+00	1.97E+00
Summer	0	0	0.00												
Winter	93000	5	0.19	*	*	*	*	*	*	*	*	*	*	*	*
<b>Urbanization</b>															
Central City	190000	9	0.34	*	*	*	*	*	*	*	*	*	*	*	*
Nonmetropolitan	215000	27	0.48	7.59E-01	1.19E-01	1.00E-01	1.13E-01	1.41E-01	2.30E-01	5.43E-01	1.24E+00	1.75E+00	1.92E+00	1.97E+00	1.97E+00
Suburban	358000	30	0.41	4.27E-01	4.05E-02	1.10E-01	1.69E-01	1.81E-01	2.75E-01	3.65E-01	5.79E-01	7.01E-01	9.31E-01	1.12E+00	1.12E+00
<b>Race</b>															
Black	0	0	0.00												
White	763000	66	0.48	5.59E-01	5.12E-02	1.00E-01	1.41E-01	1.91E-01	2.75E-01	4.00E-01	7.07E-01	1.12E+00	1.63E+00	1.97E+00	1.97E+00
<b>Region</b>															
Midwest	368000	33	0.79	4.78E-01	6.49E-02	1.00E-01	1.10E-01	1.41E-01	2.28E-01	4.00E-01	6.14E-01	9.31E-01	1.12E+00	1.97E+00	1.97E+00
Northeast	270000	20	0.66	7.17E-01	9.99E-02	1.81E-01	2.34E-01	2.34E-01	3.65E-01	5.96E-01	9.29E-01	1.24E+00	1.63E+00	1.92E+00	1.92E+00
South	95000	9	0.15	*	*	*	*	*	*	*	*	*	*	*	*
West	30000	4	0.08	*	*	*	*	*	*	*	*	*	*	*	*
<b>Response to Questionnaire</b>															
Households who garden	669000	59	0.98	5.33E-01	5.50E-02	1.00E-01	1.41E-01	1.81E-01	2.75E-01	4.00E-01	6.99E-01	1.12E+00	1.63E+00	1.97E+00	1.97E+00
Households who farm	157000	16	2.14	*	*	*	*	*	*	*	*	*	*	*	*

\* Intake data not provided for subpopulations for which there were less than 20 observations

NOTE: SE = standard error  
P = percentile of the distribution  
Nc wgt'd = weighted number of consumers; Nc unwt'd = unweighted number of consumers in survey.  
Source: Based on EPA's analyses of the 1987-88 NFCS





Table 13-36. Consumer Only Intake of Home Produced Beef (g/kg-day)

Population Group	Nc wgtd	Nc unwtgd	% Consumin g	Mean	SE	P1	P5	P10	P25	P50	P75	P90	P95	P99	P100
Total	4958000	304	2.64	2.45E+00	1.49E-01	1.83E-01	3.74E-01	4.65E-01	8.78E-01	1.61E+00	3.07E+00	5.29E+00	7.24E+00	1.33E+01	1.94E+01
Age															
01-02	110000	8	1.93	*	*	*	*	*	*	*	*	*	*	*	*
03-05	234000	13	2.89	*	*	*	*	*	*	*	*	*	*	*	*
06-11	695000	38	4.16	3.77E+00	5.94E-01	3.54E-01	6.63E-01	7.53E-01	1.32E+00	2.11E+00	4.43E+00	1.14E+01	1.25E+01	1.33E+01	1.33E+01
12-19	656000	41	3.20	1.72E+00	1.63E-01	3.78E-01	4.78E-01	5.13E-01	8.96E-01	1.51E+00	2.44E+00	3.53E+00	3.57E+00	4.28E+00	4.28E+00
20-39	1495000	83	2.43	2.06E+00	2.00E-01	2.69E-01	3.52E-01	3.94E-01	6.80E-01	1.59E+00	2.73E+00	4.88E+00	6.50E+00	8.26E+00	8.26E+00
40-69	1490000	105	2.63	1.84E+00	1.41E-01	1.83E-01	3.61E-01	4.55E-01	8.33E-01	1.52E+00	2.38E+00	4.10E+00	5.39E+00	5.90E+00	5.90E+00
70 +	188000	11	1.18	*	*	*	*	*	*	*	*	*	*	*	*
Season															
Fall	1404000	55	2.95	1.55E+00	1.74E-01	1.83E-01	3.52E-01	3.61E-01	5.17E-01	1.33E+00	2.01E+00	2.86E+00	3.90E+00	7.24E+00	7.24E+00
Spring	911000	108	1.97	2.32E+00	1.63E-01	2.70E-01	3.90E-01	5.10E-01	1.04E+00	1.96E+00	3.29E+00	4.22E+00	5.23E+00	8.62E+00	9.28E+00
Summer	1755000	69	3.86	3.48E+00	4.12E-01	1.02E-01	6.08E-01	7.45E-01	1.02E+00	2.44E+00	4.43E+00	7.51E+00	1.14E+01	1.87E+01	1.87E+01
Winter	888000	72	1.82	1.95E+00	2.75E-01	3.93E-02	3.75E-01	3.94E-01	6.74E-01	1.33E+00	2.14E+00	4.23E+00	5.39E+00	1.94E+01	1.94E+01
Urbanization															
Central City	100000	5	0.18	*	*	*	*	*	*	*	*	*	*	*	*
Nonmetropolitan	3070000	194	6.82	2.80E+00	2.18E-01	1.83E-01	3.77E-01	4.99E-01	8.64E-01	1.81E+00	3.57E+00	6.03E+00	8.44E+00	1.87E+01	1.94E+01
Suburban	1788000	105	2.07	1.93E+00	1.50E-01	2.67E-01	3.75E-01	4.16E-01	9.07E-01	1.52E+00	2.44E+00	4.06E+00	5.10E+00	7.51E+00	9.28E+00
Race															
Black	0	0	0.00												
White	4950000	303	3.14	2.45E+00	1.50E-01	1.83E-01	3.74E-01	4.65E-01	8.78E-01	1.61E+00	3.07E+00	5.29E+00	7.24E+00	1.33E+01	1.94E+01
Region															
Midwest	2261000	161	4.87	2.83E+00	2.31E-01	1.83E-01	3.54E-01	4.16E-01	8.47E-01	2.01E+00	3.66E+00	5.90E+00	8.39E+00	1.87E+01	1.87E+01
Northeast	586000	25	1.42	1.44E+00	2.13E-01	3.52E-01	3.52E-01	4.73E-01	7.42E-01	1.06E+00	1.68E+00	2.62E+00	2.62E+00	6.03E+00	6.03E+00
South	1042000	61	1.62	2.45E+00	3.46E-01	1.02E-01	3.90E-01	5.84E-01	8.16E-01	1.59E+00	2.41E+00	6.36E+00	7.24E+00	1.33E+01	1.33E+01
West	1069000	57	2.96	2.20E+00	2.83E-01	3.13E-01	3.80E-01	5.56E-01	1.04E+00	1.60E+00	2.86E+00	4.06E+00	4.42E+00	7.51E+00	1.94E+01
Response to Questionnaire															
Households who raise animals	3699000	239	36.63	2.66E+00	1.60E-01	1.83E-01	3.88E-01	6.63E-01	1.04E+00	1.83E+00	3.48E+00	5.39E+00	7.51E+00	1.25E+01	1.94E+01
Households who farm	2850000	182	38.89	2.63E+00	1.96E-01	2.70E-01	3.94E-01	5.85E-01	8.96E-01	1.64E+00	3.25E+00	5.39E+00	7.51E+00	1.13E+01	1.94E+01

\* Intake data not provided for subpopulations for which there were less than 20 observations

NOTE: SE = standard error  
 P = percentile of the distribution  
 Nc wgtd = weighted number of consumers; Nc unwtgd = unweighted number of consumers in survey.  
 Source: Based on EPA's analyses of the 1987-88 NFCS



Table 13-37. Consumer Only Intake of Homegrown Beets (g/kg-day)

Population Group	Nc wgtd	Nc unwgtd	% Consuming	Mean	SE	P1	P5	P10	P25	P50	P75	P90	P95	P99	P100
Total	2214000	125	1.18	5.12E-01	4.96E-02	3.21E-02	7.37E-02	1.09E-01	1.88E-01	3.97E-01	5.87E-01	1.03E+00	1.36E+00	3.69E+00	4.08E+00
<b>Age</b>															
01-02	27000	2	0.47	*	*	*	*	*	*	*	*	*	*	*	*
03-05	51000	4	0.63	*	*	*	*	*	*	*	*	*	*	*	*
06-11	167000	10	1.00	*	*	*	*	*	*	*	*	*	*	*	*
12-19	227000	13	1.11	*	*	*	*	*	*	*	*	*	*	*	*
20-39	383000	22	0.62	3.81E-01	6.26E-02	7.57E-02	7.57E-02	1.22E-01	1.43E-01	2.85E-01	5.56E-01	9.99E-01	9.99E-01	1.12E+00	1.12E+00
40-69	951000	51	1.68	4.28E-01	4.34E-02	5.00E-02	7.31E-02	7.46E-02	2.05E-01	3.97E-01	5.49E-01	9.25E-01	1.15E+00	1.40E+00	1.40E+00
70 +	408000	23	2.57	5.80E-01	8.80E-02	3.21E-02	3.21E-02	4.76E-02	2.71E-01	4.49E-01	9.09E-01	1.36E+00	1.36E+00	1.59E+00	1.59E+00
<b>Season</b>															
Fall	562000	21	1.18	5.45E-01	9.36E-02	3.21E-02	4.76E-02	5.00E-02	2.57E-01	3.56E-01	9.49E-01	1.36E+00	1.36E+00	1.40E+00	1.40E+00
Spring	558000	55	1.21	4.70E-01	8.98E-02	7.46E-02	8.06E-02	1.09E-01	1.43E-01	2.73E-01	4.47E-01	8.73E-01	1.59E+00	4.08E+00	4.08E+00
Summer	676000	22	1.49	3.85E-01	4.54E-02	7.57E-02	1.20E-01	1.22E-01	1.84E-01	3.97E-01	5.49E-01	6.24E-01	9.09E-01	9.09E-01	9.09E-01
Winter	418000	27	0.86	7.30E-01	1.54E-01	7.31E-02	7.31E-02	7.37E-02	2.80E-01	5.20E-01	8.28E-01	1.13E+00	2.32E+00	3.69E+00	3.69E+00
<b>Urbanization</b>															
Central City	651000	27	1.16	5.18E-01	1.15E-01	1.11E-01	1.35E-01	1.83E-01	2.57E-01	4.01E-01	5.49E-01	9.09E-01	1.12E+00	3.69E+00	3.69E+00
Nonmetropolitan	758000	51	1.68	5.77E-01	9.06E-02	5.00E-02	7.31E-02	7.37E-02	1.80E-01	3.86E-01	6.61E-01	1.36E+00	1.40E+00	4.08E+00	4.08E+00
Suburban	805000	47	0.93	4.45E-01	5.77E-02	3.21E-02	4.76E-02	8.06E-02	1.43E-01	3.97E-01	5.56E-01	9.25E-01	9.99E-01	2.32E+00	2.32E+00
<b>Race</b>															
Black	0	0	0.00												
White	2186000	124	1.39	5.18E-01	4.99E-02	3.21E-02	7.46E-02	1.13E-01	2.05E-01	3.97E-01	5.87E-01	1.03E+00	1.36E+00	3.69E+00	4.08E+00
<b>Region</b>															
Midwest	885000	53	1.91	6.30E-01	7.93E-02	5.00E-02	1.13E-01	1.83E-01	3.15E-01	4.54E-01	9.09E-01	1.15E+00	1.36E+00	3.69E+00	3.69E+00
Northeast	230000	13	0.56	*	*	*	*	*	*	*	*	*	*	*	*
South	545000	31	0.85	4.51E-01	1.17E-01	7.46E-02	7.57E-02	8.06E-02	1.80E-01	2.64E-01	4.84E-01	6.61E-01	9.44E-01	4.08E+00	4.08E+00
West	554000	28	1.54	3.96E-01	7.75E-02	3.21E-02	4.76E-02	7.31E-02	1.21E-01	2.86E-01	5.49E-01	6.24E-01	7.04E-01	2.32E+00	2.32E+00
<b>Response to Questionnaire</b>															
Households who garden	2107000	120	3.09	5.26E-01	5.16E-02	3.21E-02	7.37E-02	9.56E-02	2.05E-01	4.01E-01	6.06E-01	1.03E+00	1.36E+00	3.69E+00	4.08E+00
Households who farm	229000	11	3.12	*	*	*	*	*	*	*	*	*	*	*	*

\* Intake data not provided for subpopulations for which there were less than 20 observations

NOTE: SE = standard error  
P = percentile of the distribution  
Nc wgtd = weighted number of consumers; Nc unwgtd = unweighted number of consumers in survey.  
Source: Based on EPA's analyses of the 1987-88 NFCS



Table 13-38. Consumer Only Intake of Homegrown Broccoli (g/kg-day)

Population Group	Nc wgtd	Nc unwgtd	% Consuming	Mean	SE	P1	P5	P10	P25	P50	P75	P90	P95	P99	P100
Total	1745000	80	0.93	4.20E-01	4.75E-02	7.61E-02	8.24E-02	1.56E-01	1.96E-01	2.90E-01	4.59E-01	8.15E-01	9.74E-01	2.48E+00	3.02E+00
Age															
01-02	0	0	0.00	*	*	*	*	*	*	*	*	*	*	*	*
03-05	13000	1	0.16	*	*	*	*	*	*	*	*	*	*	*	*
06-11	187000	9	1.12	*	*	*	*	*	*	*	*	*	*	*	*
12-19	102000	4	0.50	*	*	*	*	*	*	*	*	*	*	*	*
20-39	486000	19	0.79	*	*	*	*	*	*	*	*	*	*	*	*
40-69	761000	37	1.34	4.12E-01	6.50E-02	8.24E-02	1.06E-01	1.64E-01	2.22E-01	3.51E-01	4.61E-01	6.14E-01	8.15E-01	3.02E+00	3.02E+00
70 +	196000	10	1.23	*	*	*	*	*	*	*	*	*	*	*	*
Season															
Fall	624000	20	1.31	2.87E-01	3.70E-02	7.99E-02	7.99E-02	8.24E-02	1.75E-01	2.31E-01	3.79E-01	4.52E-01	5.29E-01	8.15E-01	8.15E-01
Spring	258000	27	0.56	5.43E-01	1.18E-01	4.50E-02	1.54E-01	1.70E-01	2.65E-01	3.31E-01	5.89E-01	1.25E+00	2.37E+00	3.02E+00	3.02E+00
Summer	682000	22	1.50	5.08E-01	1.05E-01	7.61E-02	1.29E-01	1.78E-01	2.15E-01	3.99E-01	6.61E-01	8.86E-01	9.74E-01	2.48E+00	2.48E+00
Winter	181000	11	0.37	*	*	*	*	*	*	*	*	*	*	*	*
Urbanization															
Central City	165000	5	0.29	*	*	*	*	*	*	*	*	*	*	*	*
Nonmetropolitan	647000	34	1.44	4.23E-01	4.21E-02	4.50E-02	1.29E-01	1.70E-01	2.23E-01	3.69E-01	5.89E-01	7.47E-01	8.86E-01	9.74E-01	9.74E-01
Suburban	933000	41	1.08	4.29E-01	8.26E-02	7.99E-02	8.24E-02	1.44E-01	2.13E-01	2.44E-01	4.41E-01	6.84E-01	2.37E+00	2.48E+00	3.02E+00
Race															
Black	0	0	0.00	*	*	*	*	*	*	*	*	*	*	*	*
White	1719000	79	1.09	4.22E-01	4.81E-02	7.61E-02	8.24E-02	1.56E-01	1.96E-01	2.88E-01	4.59E-01	8.15E-01	9.74E-01	2.48E+00	3.02E+00
Region															
Midwest	792000	38	1.71	2.63E-01	5.86E-02	7.61E-02	7.99E-02	8.24E-02	1.75E-01	2.13E-01	2.75E-01	3.44E-01	4.03E-01	3.02E+00	3.02E+00
Northeast	427000	19	1.04	*	*	*	*	*	*	*	*	*	*	*	*
South	373000	16	0.58	*	*	*	*	*	*	*	*	*	*	*	*
West	153000	7	0.42	*	*	*	*	*	*	*	*	*	*	*	*
Response to Questionnaire															
Households who garden	1729000	78	2.54	4.22E-01	4.83E-02	7.61E-02	8.24E-02	1.64E-01	1.96E-01	2.90E-01	4.59E-01	8.15E-01	9.74E-01	2.48E+00	3.02E+00
Households who farm	599000	29	8.17	4.66E-01	8.37E-02	4.50E-02	7.61E-02	1.54E-01	1.95E-01	3.10E-01	6.61E-01	8.86E-01	9.74E-01	3.02E+00	3.02E+00

\* Intake data not provided for subpopulations for which there were less than 20 observations

NOTE: SE = standard error  
P = percentile of the distribution  
Nc wgtd = weighted number of consumers; Nc unwgtd = unweighted number of consumers in survey.

Source: Based on EPA's analyses of the 1987-88 NFCS



Table 13-39. Consumer Only Intake of Homegrown Cabbage (g/kg-day)

Population Group	Nc wgted	Nc unwgted	% Consuming	Mean	SE	P1	P5	P10	P25	P50	P75	P90	P95	P99	P100
Total	2019000	89	1.07	1.03E+00	1.00E-01	1.07E-01	2.03E-01	3.17E-01	4.21E-01	7.76E-01	1.33E+00	1.97E+00	2.35E+00	5.43E+00	5.43E+00
Age															
01-02	14000	2	0.25	*	*	*	*	*	*	*	*	*	*	*	*
03-05	29000	1	0.36	*	*	*	*	*	*	*	*	*	*	*	*
06-11	61000	3	0.37	*	*	*	*	*	*	*	*	*	*	*	*
12-19	203000	9	0.99	*	*	*	*	*	*	*	*	*	*	*	*
20-39	391000	16	0.63	*	*	*	*	*	*	*	*	*	*	*	*
40-69	966000	44	1.70	1.14E+00	1.80E-01	2.17E-01	2.22E-01	3.25E-01	4.08E-01	7.13E-01	1.41E+00	1.82E+00	5.29E+00	5.43E+00	5.43E+00
70 +	326000	13	2.05	*	*	*	*	*	*	*	*	*	*	*	*
Season															
Fall	570000	21	1.20	1.28E+00	3.24E-01	1.86E-01	1.86E-01	2.03E-01	3.85E-01	5.42E-01	1.49E+00	5.29E+00	5.43E+00	5.43E+00	5.43E+00
Spring	126000	15	0.27	*	*	*	*	*	*	*	*	*	*	*	*
Summer	1142000	39	2.51	9.65E-01	9.35E-02	2.01E-01	2.22E-01	3.25E-01	5.55E-01	8.28E-01	1.24E+00	1.79E+00	2.35E+00	2.77E+00	2.77E+00
Winter	181000	14	0.37	*	*	*	*	*	*	*	*	*	*	*	*
Urbanization															
Central City	157000	5	0.28	*	*	*	*	*	*	*	*	*	*	*	*
Nonmetropolitan	1079000	48	2.40	9.37E-01	8.83E-02	2.01E-01	3.17E-01	3.40E-01	4.54E-01	7.13E-01	1.33E+00	1.79E+00	2.35E+00	2.77E+00	2.77E+00
Suburban	783000	36	0.90	1.26E+00	2.11E-01	3.20E-02	2.22E-01	3.25E-01	4.49E-01	1.05E+00	1.37E+00	2.17E+00	5.29E+00	5.43E+00	5.43E+00
Race															
Black	7000	1	0.03	*	*	*	*	*	*	*	*	*	*	*	*
White	1867000	83	1.19	1.05E+00	1.07E-01	1.07E-01	2.03E-01	2.46E-01	4.13E-01	7.88E-01	1.37E+00	1.97E+00	2.35E+00	5.43E+00	5.43E+00
Region															
Midwest	884000	37	1.91	7.42E-01	7.35E-02	1.07E-01	1.86E-01	2.22E-01	3.55E-01	5.95E-01	1.10E+00	1.29E+00	1.49E+00	1.82E+00	1.98E+00
Northeast	277000	11	0.67	*	*	*	*	*	*	*	*	*	*	*	*
South	616000	32	0.96	1.11E+00	1.34E-01	3.20E-02	2.01E-01	2.17E-01	4.49E-01	8.50E-01	1.79E+00	2.17E+00	2.35E+00	2.77E+00	2.77E+00
West	242000	9	0.67	*	*	*	*	*	*	*	*	*	*	*	*
Response to Questionnaire															
Households who garden	1921000	86	2.82	1.07E+00	1.03E-01	1.07E-01	2.03E-01	3.17E-01	4.54E-01	7.88E-01	1.37E+00	1.97E+00	2.35E+00	5.43E+00	5.43E+00
Households who farm	546000	26	7.45	9.96E-01	1.15E-01	2.01E-01	2.06E-01	3.51E-01	5.87E-01	8.28E-01	1.37E+00	1.79E+00	2.35E+00	2.35E+00	2.35E+00
* Intake data not provided for subpopulations for which there were less than 20 observations															
NOTE: SE = standard error P = percentile of the distribution Nc wgted = weighted number of consumers; Nc unwgted = unweighted number of consumers in survey.															
Source: Based on EPA's analyses of the 1987-88 NFCS															



Table 13-40. Consumer Only Intake of Homegrown Carrots (g/kg-day)

Population Group	Nc wgted	Nc unwtgd	% Consuming	Mean	SE	P1	P5	P10	P25	P50	P75	P90	P95	P99	P100
Total	4322000	193	2.30	4.38E-01	4.29E-02	4.12E-02	6.35E-02	9.23E-02	1.79E-01	3.28E-01	5.25E-01	7.95E-01	1.08E+00	2.21E+00	7.79E+00
<b>Age</b>															
01-02	51000	4	0.89	*	*	*	*	*	*	*	*	*	*	*	*
03-05	53000	3	0.65	*	*	*	*	*	*	*	*	*	*	*	*
06-11	299000	14	1.79	*	*	*	*	*	*	*	*	*	*	*	*
12-19	389000	17	1.90	*	*	*	*	*	*	*	*	*	*	*	*
20-39	1043000	46	1.69	2.83E-01	3.46E-02	4.47E-02	5.02E-02	8.00E-02	1.20E-01	1.99E-01	4.09E-01	5.64E-01	7.56E-01	1.19E+00	1.19E+00
40-69	1848000	82	3.26	4.25E-01	3.42E-02	3.90E-02	6.74E-02	1.23E-01	2.15E-01	3.67E-01	5.50E-01	7.76E-01	1.01E+00	1.53E+00	2.21E+00
70 +	574000	24	3.61	4.44E-01	5.50E-02	7.39E-02	1.79E-01	1.96E-01	2.60E-01	3.70E-01	5.39E-01	9.64E-01	1.08E+00	1.08E+00	1.08E+00
<b>Season</b>															
Fall	1810000	66	3.80	4.61E-01	9.77E-02	9.09E-02	1.10E-01	1.20E-01	1.99E-01	3.08E-01	5.09E-01	7.76E-01	1.08E+00	1.71E+00	7.79E+00
Spring	267000	28	0.58	5.55E-01	1.01E-01	1.39E-01	1.49E-01	2.02E-01	2.16E-01	3.92E-01	6.09E-01	9.94E-01	2.11E+00	2.94E+00	2.94E+00
Summer	1544000	49	3.39	3.88E-01	3.95E-02	4.12E-02	5.02E-02	6.74E-02	1.64E-01	3.76E-01	5.13E-01	8.40E-01	9.64E-01	1.19E+00	1.19E+00
Winter	701000	50	1.44	4.44E-01	7.44E-02	3.90E-02	4.34E-02	6.35E-02	1.56E-01	2.25E-01	6.40E-01	1.05E+00	1.53E+00	3.06E+00	3.06E+00
<b>Urbanization</b>															
Central City	963000	29	1.71	2.82E-01	3.86E-02	3.90E-02	6.35E-02	8.00E-02	1.63E-01	2.09E-01	3.85E-01	5.25E-01	5.88E-01	9.64E-01	9.64E-01
Nonmetropolitan	1675000	94	3.72	5.18E-01	8.98E-02	4.12E-02	5.36E-02	6.81E-02	2.00E-01	3.28E-01	5.13E-01	9.55E-01	1.19E+00	7.79E+00	7.79E+00
Suburban	1684000	70	1.94	4.48E-01	4.02E-02	6.74E-02	9.09E-02	1.16E-01	2.02E-01	3.77E-01	6.35E-01	7.95E-01	1.09E+00	1.71E+00	1.71E+00
<b>Race</b>															
Black	107000	7	0.49	*	*	*	*	*	*	*	*	*	*	*	*
White	3970000	178	2.52	4.13E-01	2.58E-02	4.34E-02	7.96E-02	1.11E-01	1.94E-01	3.33E-01	5.27E-01	7.76E-01	1.01E+00	1.59E+00	3.06E+00
<b>Region</b>															
Midwest	2001000	97	4.31	4.57E-01	3.99E-02	3.90E-02	8.00E-02	1.37E-01	2.00E-01	3.73E-01	5.39E-01	9.55E-01	1.10E+00	2.11E+00	3.06E+00
Northeast	735000	29	1.79	4.05E-01	8.79E-02	4.12E-02	5.36E-02	6.15E-02	9.34E-02	1.49E-01	6.35E-01	1.09E+00	1.71E+00	2.21E+00	2.21E+00
South	378000	20	0.59	6.27E-01	3.60E-01	4.47E-02	4.47E-02	5.02E-02	1.49E-01	2.72E-01	4.09E-01	5.02E-01	9.94E-01	7.79E+00	7.79E+00
West	1208000	47	3.35	3.68E-01	3.24E-02	6.74E-02	9.11E-02	1.43E-01	1.90E-01	3.33E-01	4.59E-01	7.56E-01	8.40E-01	9.64E-01	9.64E-01
<b>Response to Questionnaire</b>															
Households who garden	4054000	182	5.95	4.04E-01	2.67E-02	4.12E-02	6.81E-02	9.34E-02	1.79E-01	3.28E-01	5.09E-01	7.62E-01	1.08E+00	1.71E+00	3.06E+00
Households who farm	833000	40	11.37	3.60E-01	5.95E-02	9.09E-02	9.34E-02	1.10E-01	1.79E-01	2.28E-01	4.59E-01	6.19E-01	1.19E+00	2.11E+00	2.94E+00

\* Intake data not provided for subpopulations for which there were less than 20 observations

NOTE: SE = standard error  
 P = percentile of the distribution  
 Nc wgted = weighted number of consumers; Nc unwtgd = unweighted number of consumers in survey.  
 Source: Based on EPA' analyses of the 1987-88 NFCS



Table 13-41. Consumer Only Intake of Homegrown Corn (g/kg-day)

Population Group	Nc wgtd	Nc unwtgd	% Consuming	Mean	SE	P1	P5	P10	P25	P50	P75	P90	P95	P99	P100
Total	6891000	421	3.67	8.92E-01	6.48E-02	5.15E-02	1.22E-01	1.65E-01	2.44E-01	4.80E-01	9.07E-01	1.88E+00	3.37E+00	7.44E+00	9.23E+00
Age															
01-02	205000	13	3.60	*	*	*	*	*	*	*	*	*	*	*	*
03-05	313000	24	3.86	1.25E+00	2.57E-01	3.25E-01	3.25E-01	4.00E-01	5.98E-01	1.00E+00	1.21E+00	1.67E+00	5.35E+00	5.35E+00	5.35E+00
06-11	689000	43	4.12	9.32E-01	1.66E-01	1.10E-01	1.19E-01	1.89E-01	2.52E-01	5.13E-01	1.08E+00	3.13E+00	3.37E+00	4.52E+00	4.52E+00
12-19	530000	32	2.59	5.92E-01	9.56E-02	9.87E-02	1.05E-01	1.35E-01	2.12E-01	3.43E-01	7.11E-01	1.55E+00	1.88E+00	1.88E+00	1.88E+00
20-39	1913000	108	3.11	5.97E-01	6.00E-02	6.59E-02	1.41E-01	1.52E-01	2.08E-01	3.71E-01	7.08E-01	1.53E+00	2.04E+00	3.70E+00	3.70E+00
40-69	2265000	142	3.99	8.64E-01	1.05E-01	1.13E-01	1.52E-01	1.66E-01	2.55E-01	5.16E-01	8.83E-01	1.42E+00	3.22E+00	7.44E+00	7.44E+00
70 +	871000	53	5.48	9.43E-01	2.59E-01	3.91E-02	5.15E-02	1.05E-01	1.88E-01	3.64E-01	7.57E-01	1.34E+00	6.49E+00	9.23E+00	9.23E+00
Season															
Fall	2458000	89	5.16	5.44E-01	8.37E-02	3.91E-02	1.05E-01	1.42E-01	1.88E-01	3.17E-01	5.46E-01	1.27E+00	1.42E+00	5.35E+00	5.69E+00
Spring	1380000	160	2.99	6.35E-01	5.57E-02	1.42E-01	1.68E-01	1.93E-01	2.64E-01	4.48E-01	7.68E-01	1.21E+00	1.57E+00	5.15E+00	6.68E+00
Summer	1777000	62	3.91	1.82E+00	2.62E-01	6.59E-02	1.78E-01	3.43E-01	6.44E-01	9.36E-01	2.13E+00	4.52E+00	6.84E+00	9.23E+00	9.23E+00
Winter	1276000	110	2.62	5.45E-01	4.67E-02	1.14E-01	1.20E-01	1.49E-01	2.22E-01	4.05E-01	6.14E-01	1.16E+00	1.47E+00	2.04E+00	3.94E+00
Urbanization															
Central City	748000	27	1.33	7.37E-01	1.41E-01	3.91E-02	3.91E-02	5.15E-02	1.77E-01	5.46E-01	9.29E-01	2.04E+00	2.23E+00	3.04E+00	3.04E+00
Nonmetropolitan	4122000	268	9.16	9.63E-01	8.18E-02	7.40E-02	1.22E-01	1.66E-01	2.49E-01	5.31E-01	1.00E+00	2.13E+00	3.38E+00	7.44E+00	8.97E+00
Suburban	2021000	126	2.33	8.04E-01	1.30E-01	1.05E-01	1.53E-01	1.66E-01	2.39E-01	3.96E-01	6.47E-01	1.34E+00	1.71E+00	9.23E+00	9.23E+00
Race															
Black	188000	9	0.86	*	*	*	*	*	*	*	*	*	*	*	*
White	6703000	412	4.26	8.87E-01	6.51E-02	5.15E-02	1.22E-01	1.63E-01	2.37E-01	4.80E-01	8.84E-01	1.88E+00	3.22E+00	7.44E+00	9.23E+00
Region															
Midwest	2557000	188	5.51	9.34E-01	9.74E-02	3.91E-02	1.19E-01	1.68E-01	2.47E-01	4.56E-01	9.29E-01	2.28E+00	3.22E+00	6.84E+00	7.44E+00
Northeast	586000	33	1.42	6.14E-01	8.42E-02	9.87E-02	1.66E-01	1.86E-01	2.44E-01	3.81E-01	8.83E-01	1.34E+00	1.71E+00	1.71E+00	1.71E+00
South	2745000	153	4.27	8.73E-01	9.52E-02	7.40E-02	1.22E-01	1.66E-01	2.83E-01	5.61E-01	9.35E-01	1.55E+00	3.37E+00	5.69E+00	8.97E+00
West	1003000	47	2.78	9.99E-01	2.77E-01	1.05E-01	1.47E-01	1.52E-01	1.77E-01	3.96E-01	7.45E-01	2.23E+00	6.49E+00	9.23E+00	9.23E+00
Response to Questionnaire															
Households who garden	6233000	387	9.15	8.75E-01	6.30E-02	5.15E-02	1.35E-01	1.65E-01	2.44E-01	5.02E-01	9.14E-01	1.82E+00	3.13E+00	6.84E+00	9.23E+00
Households who farm	1739000	114	23.73	1.20E+00	1.77E-01	3.91E-02	1.08E-01	1.66E-01	2.29E-01	3.81E-01	9.74E-01	3.37E+00	6.49E+00	9.23E+00	9.23E+00

\* Intake data not provided for subpopulations for which there were less than 20 observations

NOTE: SE = standard error  
P = percentile of the distributions  
Nc wgtd = weighted number of consumers; Nc unwtgd = unweighted number of consumers in survey.  
Source: Based on EPA's analyses of the 1987-88 NFCS



Table 13-42. Consumer Only Intake of Homegrown Cucumbers (g/kg-day)

Population Group	Nc wgtd	Nc unwtgd	% Consuming	Mean	SE	P1	P5	P10	P25	P50	P75	P90	P95	P99	P100
Total	3994000	141	2.12	1.02E+00	1.55E-01	3.08E-02	6.71E-02	1.08E-01	2.40E-01	5.40E-01	1.13E+00	2.11E+00	2.79E+00	1.34E+01	1.37E+01
<b>Age</b>															
01-02	132000	5	2.32	*	*	*	*	*	*	*	*	*	*	*	*
03-05	107000	4	1.32	*	*	*	*	*	*	*	*	*	*	*	*
06-11	356000	12	2.13	*	*	*	*	*	*	*	*	*	*	*	*
12-19	254000	10	1.24	*	*	*	*	*	*	*	*	*	*	*	*
20-39	864000	29	1.40	5.04E-01	9.27E-02	3.08E-02	5.45E-02	6.31E-02	1.83E-01	3.09E-01	6.17E-01	1.35E+00	1.49E+00	2.12E+00	2.12E+00
40-69	1882000	68	3.32	1.33E+00	3.01E-01	4.16E-02	7.46E-02	1.76E-01	3.93E-01	6.84E-01	1.29E+00	2.11E+00	3.27E+00	1.37E+01	1.37E+01
70 +	399000	13	2.51	*	*	*	*	*	*	*	*	*	*	*	*
<b>Season</b>															
Fall	370000	12	0.78	*	*	*	*	*	*	*	*	*	*	*	*
Spring	197000	15	0.43	*	*	*	*	*	*	*	*	*	*	*	*
Summer	3427000	114	7.53	1.06E+00	1.83E-01	0.00E+00	7.46E-02	1.08E-01	2.42E-01	5.18E-01	1.13E+00	2.12E+00	2.79E+00	1.34E+01	1.37E+01
Winter	0	0	0.00												
<b>Urbanization</b>															
Central City	640000	18	1.14	*	*	*	*	*	*	*	*	*	*	*	*
Nonmetropolitan	1530000	64	3.40	1.74E+00	3.43E-01	1.01E-01	1.21E-01	1.90E-01	3.86E-01	1.06E+00	1.67E+00	3.09E+00	4.50E+00	1.37E+01	1.37E+01
Suburban	1824000	59	2.11	6.71E-01	7.52E-02	0.00E+00	7.46E-02	1.62E-01	2.78E-01	4.99E-01	8.33E-01	1.34E+00	1.73E+00	3.27E+00	3.27E+00
<b>Race</b>															
Black	86000	2	0.40	*	*	*	*	*	*	*	*	*	*	*	*
White	3724000	132	2.36	9.35E-01	1.62E-01	3.08E-02	6.31E-02	1.01E-01	2.22E-01	5.01E-01	1.03E+00	1.49E+00	2.40E+00	1.34E+01	1.37E+01
<b>Region</b>															
Midwest	969000	31	2.09	1.00E+00	3.92E-01	3.08E-02	4.16E-02	5.45E-02	1.35E-01	4.53E-01	1.03E+00	2.35E+00	2.45E+00	1.34E+01	1.34E+01
Northeast	689000	22	1.67	1.92E+00	6.78E-01	2.33E-01	2.78E-01	2.78E-01	4.75E-01	6.84E-01	1.53E+00	4.18E+00	1.17E+01	1.37E+01	1.37E+01
South	1317000	54	2.05	8.85E-01	1.05E-01	0.00E+00	1.21E-01	1.83E-01	2.87E-01	7.53E-01	1.28E+00	1.73E+00	2.13E+00	4.50E+00	4.50E+00
West	1019000	34	2.83	6.01E-01	1.06E-01	6.71E-02	7.46E-02	1.01E-01	2.09E-01	4.30E-01	7.01E-01	1.29E+00	2.11E+00	3.27E+00	3.27E+00
<b>Response to Questionnaire</b>															
Households who garden	3465000	123	5.08	1.05E+00	1.75E-01	3.08E-02	6.71E-02	1.01E-01	2.78E-01	5.18E-01	1.13E+00	2.11E+00	2.79E+00	1.34E+01	1.37E+01
Households who farm	710000	29	9.69	6.99E-01	1.07E-01	0.00E+00	0.00E+00	1.43E-01	1.88E-01	3.86E-01	1.27E+00	1.49E+00	1.71E+00	2.09E+00	2.09E+00

\* Intake data not provided for subpopulations for which there were less than 20 observations

NOTE: SE = standard error  
P = percentile of the distribution  
Nc wgtd = weighted number of consumers; Nc unwtgd = unweighted number of consumers in survey.  
Source: Based on EPA's analyses of the 1987-88 NFCS



Table 13-43. Consumer Only Intake of Home Produced Eggs (g/kg-day)

Population Group	Nc wgtd	Nc unwtgd	% Consuming	Mean	SE	P1	P5	P10	P25	P50	P75	P90	P95	P99	P100
Total	2075000	124	1.10	7.31E-01	1.00E-01	7.16E-02	1.50E-01	1.75E-01	2.68E-01	4.66E-01	9.02E-01	1.36E+00	1.69E+00	6.58E+00	1.35E+01
<b>Age</b>															
01-02	21000	3	0.37	*	*	*	*	*	*	*	*	*	*	*	*
03-05	20000	2	0.25	*	*	*	*	*	*	*	*	*	*	*	*
06-11	170000	12	1.02	*	*	*	*	*	*	*	*	*	*	*	*
12-19	163000	14	0.80	*	*	*	*	*	*	*	*	*	*	*	*
20-39	474000	30	0.77	6.32E-01	9.23E-02	7.16E-02	7.16E-02	2.15E-01	3.00E-01	4.16E-01	8.14E-01	1.32E+00	1.93E+00	2.50E+00	2.50E+00
40-69	718000	43	1.27	5.91E-01	5.77E-02	1.37E-01	1.41E-01	1.52E-01	3.17E-01	5.14E-01	8.44E-01	1.30E+00	1.36E+00	1.38E+00	1.38E+00
70 +	489000	18	3.08	*	*	*	*	*	*	*	*	*	*	*	*
<b>Seasons</b>															
Fall	542000	18	1.14	*	*	*	*	*	*	*	*	*	*	*	*
Spring	460000	54	1.00	1.31E+00	2.88E-01	1.57E-01	3.25E-01	3.94E-01	5.02E-01	6.66E-01	1.31E+00	2.10E+00	3.26E+00	1.35E+01	1.35E+01
Summer	723000	26	1.59	4.96E-01	8.14E-02	7.16E-02	1.37E-01	1.41E-01	2.60E-01	3.32E-01	5.41E-01	1.36E+00	1.51E+00	1.65E+00	1.65E+00
Winter	350000	26	0.72	8.60E-01	9.50E-02	1.67E-01	1.75E-01	2.15E-01	4.03E-01	7.51E-01	1.17E+00	1.62E+00	1.93E+00	1.93E+00	1.93E+00
<b>Urbanization</b>															
Central City	251000	9	0.45	*	*	*	*	*	*	*	*	*	*	*	*
Nonmetropolitan	1076000	65	2.39	7.34E-01	1.23E-01	7.16E-02	1.41E-01	1.67E-01	2.60E-01	4.74E-01	9.16E-01	1.34E+00	1.65E+00	6.58E+00	9.16E+00
Suburban	748000	50	0.86	8.54E-01	1.98E-01	1.37E-01	1.50E-01	2.06E-01	3.80E-01	5.88E-01	1.17E+00	1.36E+00	1.85E+00	1.35E+01	1.35E+01
<b>Race</b>															
Black	63000	9	0.29	*	*	*	*	*	*	*	*	*	*	*	*
White	2012000	115	1.28	7.41E-01	1.05E-01	7.16E-02	1.50E-01	1.75E-01	2.68E-01	4.82E-01	9.03E-01	1.36E+00	1.69E+00	6.58E+00	1.35E+01
<b>Region</b>															
Midwest	665000	37	1.43	7.93E-01	1.96E-01	7.16E-02	1.37E-01	1.41E-01	2.17E-01	3.39E-01	1.08E+00	1.51E+00	2.10E+00	9.16E+00	9.16E+00
Northeast	87000	7	0.21	*	*	*	*	*	*	*	*	*	*	*	*
South	823000	44	1.28	5.36E-01	6.46E-02	1.52E-01	1.77E-01	1.96E-01	2.60E-01	3.60E-01	5.99E-01	1.18E+00	1.62E+00	1.93E+00	1.93E+00
West	500000	36	1.39	9.21E-01	2.75E-01	1.67E-01	2.06E-01	2.08E-01	4.58E-01	6.66E-01	1.05E+00	1.36E+00	1.36E+00	1.35E+01	1.35E+01
<b>Response to Questionnaire</b>															
Households who raise animals	1824000	113	18.06	7.46E-01	1.11E-01	7.16E-02	1.50E-01	1.65E-01	2.56E-01	4.82E-01	9.02E-01	1.36E+00	1.85E+00	6.58E+00	1.35E+01
Households who farm	741000	44	10.11	8.98E-01	1.70E-01	1.52E-01	1.65E-01	1.77E-01	2.72E-01	6.66E-01	1.19E+00	1.65E+00	1.85E+00	6.58E+00	9.16E+00

\* Intake data not provided for subpopulations for which there were less than 20 observations

NOTE: SE = standard error  
P = percentile of the distribution

Nc wgtd = weighted number of consumers; Nc unwtgd = unweighted number of consumers in survey.

Source: Based on EPA's analyses of the 1987-88 NFCS





Table 13-44. Consumer Only Intake of Home Produced Game (g/kg-day)

Population Group	Nc wgtd	Nc unwgtd	% Consuming	Mean	SE	P1	P5	P10	P25	P50	P75	P90	P95	P99	P100
Total	2707000	185	1.44	9.67E-01	6.14E-02	0.00E+00	1.17E-01	2.10E-01	3.97E-01	7.09E-01	1.22E+00	2.27E+00	2.67E+00	3.61E+00	4.59E+00
<b>Age</b>															
01-02	89000	8	1.56	*	*	*	*	*	*	*	*	*	*	*	*
03-05	94000	8	1.16	*	*	*	*	*	*	*	*	*	*	*	*
06-11	362000	28	2.17	1.09E+00	1.44E-01	1.16E-01	2.31E-01	4.28E-01	6.33E-01	7.61E-01	1.48E+00	2.67E+00	2.85E+00	2.90E+00	2.90E+00
12-19	462000	27	2.25	1.04E+00	1.39E-01	2.10E-01	2.10E-01	2.91E-01	6.30E-01	8.46E-01	1.22E+00	1.99E+00	3.13E+00	3.13E+00	3.13E+00
20-39	844000	59	1.37	8.24E-01	1.08E-01	1.04E-01	1.17E-01	1.88E-01	3.01E-01	6.31E-01	1.09E+00	1.57E+00	2.50E+00	4.59E+00	4.59E+00
40-69	694000	41	1.22	9.64E-01	1.40E-01	1.24E-01	1.72E-01	2.87E-01	3.42E-01	5.10E-01	1.41E+00	2.51E+00	3.19E+00	3.61E+00	3.61E+00
70 +	74000	7	0.47	*	*	*	*	*	*	*	*	*	*	*	*
<b>Season</b>															
Fall	876000	31	1.84	9.97E-01	1.56E-01	1.17E-01	1.48E-01	2.18E-01	4.28E-01	6.33E-01	1.19E+00	2.50E+00	3.13E+00	3.19E+00	3.19E+00
Spring	554000	68	1.20	9.06E-01	8.78E-02	0.00E+00	1.04E-01	1.72E-01	4.43E-01	7.46E-01	1.22E+00	1.75E+00	2.52E+00	3.61E+00	3.61E+00
Summer	273000	9	0.60	*	*	*	*	*	*	*	*	*	*	*	*
Winter	1004000	77	2.06	1.07E+00	1.05E-01	0.00E+00	0.00E+00	1.65E-01	3.88E-01	8.18E-01	1.52E+00	2.20E+00	2.67E+00	4.59E+00	4.59E+00
<b>Urbanization</b>															
Central City	506000	20	0.90	6.89E-01	1.27E-01	0.00E+00	0.00E+00	1.88E-01	2.77E-01	6.30E-01	7.74E-01	1.48E+00	1.99E+00	2.34E+00	2.34E+00
Nonmetropolitan	1259000	101	2.80	9.45E-01	8.91E-02	0.00E+00	1.17E-01	1.65E-01	3.20E-01	6.59E-01	1.19E+00	2.27E+00	3.05E+00	4.59E+00	4.59E+00
Suburban	942000	64	1.09	1.15E+00	1.04E-01	0.00E+00	2.56E-01	3.97E-01	5.21E-01	8.18E-01	1.52E+00	2.51E+00	2.85E+00	3.13E+00	3.61E+00
<b>Race</b>															
Black	0	0	0.00												
White	2605000	182	1.65	9.77E-01	6.30E-02	0.00E+00	1.17E-01	2.02E-01	3.76E-01	7.29E-01	1.38E+00	2.34E+00	2.85E+00	3.61E+00	4.59E+00
<b>Region</b>															
Midwest	1321000	97	2.85	8.83E-01	8.32E-02	0.00E+00	7.53E-02	2.18E-01	3.42E-01	6.12E-01	1.10E+00	1.99E+00	2.51E+00	4.59E+00	4.59E+00
Northeast	394000	20	0.96	1.13E+00	2.16E-01	2.87E-01	2.87E-01	3.21E-01	4.30E-01	7.74E-01	1.41E+00	3.13E+00	3.13E+00	3.61E+00	3.61E+00
South	609000	47	0.95	1.26E+00	1.29E-01	0.00E+00	1.17E-01	1.48E-01	6.32E-01	1.09E+00	1.93E+00	2.38E+00	3.19E+00	3.19E+00	3.19E+00
West	383000	21	1.06	6.28E-01	7.21E-02	1.24E-01	1.51E-01	1.88E-01	3.97E-01	6.33E-01	7.74E-01	1.12E+00	1.22E+00	1.52E+00	1.52E+00
<b>Response to Questionnaire</b>															
Households who hunt	2357000	158	11.66	1.04E+00	6.84E-02	0.00E+00	1.40E-01	2.77E-01	4.42E-01	7.46E-01	1.44E+00	2.38E+00	2.90E+00	3.61E+00	4.59E+00
* Intake data not provided for subpopulations for which there were less than 20 observations															
NOTE: SE = standard error P = percentile of the distribution Nc wgtd = weighted number of consumers; Nc unwgtd = unweighted number of consumers in survey.															
Source: Based on EPA's analyses of the 1987-88 NFCS															



Table 13-45. Consumer Only Intake of Home Produced Lettuce (g/kg-day)

Population Group	Nc wgtd	Nc unwgtd	% Consuming	Mean	SE	P1	P5	P10	P25	P50	P75	P90	P95	P99	P100
Total	1520000	80	0.81	3.87E-01	3.18E-02	0.00E+00	4.49E-02	9.43E-02	1.70E-01	2.84E-01	5.45E-01	8.36E-01	1.03E+00	1.05E+00	1.28E+00
<b>Age</b>															
01-02	54000	4	0.95	*	*	*	*	*	*	*	*	*	*	*	*
03-05	25000	2	0.31	*	*	*	*	*	*	*	*	*	*	*	*
06-11	173000	7	1.04	*	*	*	*	*	*	*	*	*	*	*	*
12-19	71000	3	0.35	*	*	*	*	*	*	*	*	*	*	*	*
20-39	379000	17	0.62	*	*	*	*	*	*	*	*	*	*	*	*
40-69	485000	26	0.86	4.84E-01	6.07E-02	1.15E-01	1.15E-01	1.24E-01	2.21E-01	4.91E-01	6.84E-01	8.86E-01	1.05E+00	1.28E+00	1.28E+00
70 +	317000	20	2.00	4.52E-01	7.17E-02	5.04E-02	6.71E-02	1.12E-01	2.23E-01	2.88E-01	5.68E-01	1.03E+00	1.03E+00	1.03E+00	1.03E+00
<b>Season</b>															
Fall	214000	8	0.45	*	*	*	*	*	*	*	*	*	*	*	*
Spring	352000	35	0.76	4.52E-01	4.86E-02	5.04E-02	6.71E-02	1.24E-01	1.99E-01	4.53E-01	5.79E-01	7.98E-01	9.94E-01	1.28E+00	1.28E+00
Summer	856000	30	1.88	3.02E-01	3.96E-02	1.98E-02	3.35E-02	4.93E-02	1.42E-01	2.30E-01	4.24E-01	5.98E-01	8.14E-01	8.86E-01	8.86E-01
Winter	98000	7	0.20	*	*	*	*	*	*	*	*	*	*	*	*
<b>Urbanization</b>															
Central City	268000	8	0.48	*	*	*	*	*	*	*	*	*	*	*	*
Nonmetropolitan	566000	36	1.26	3.67E-01	4.78E-02	1.98E-02	3.35E-02	4.49E-02	1.23E-01	2.88E-01	5.45E-01	8.14E-01	8.86E-01	1.28E+00	1.28E+00
Suburban	686000	36	0.79	3.49E-01	4.32E-02	0.00E+00	9.43E-02	9.68E-02	1.53E-01	2.30E-01	4.91E-01	7.67E-01	9.94E-01	1.05E+00	1.05E+00
<b>Race</b>															
Black	51000	3	0.23	*	*	*	*	*	*	*	*	*	*	*	*
White	1434000	75	0.91	3.79E-01	3.33E-02	0.00E+00	4.49E-02	9.43E-02	1.56E-01	2.75E-01	5.45E-01	8.86E-01	1.03E+00	1.05E+00	1.28E+00
<b>Region</b>															
Midwest	630000	33	1.36	3.83E-01	5.54E-02	1.98E-02	3.35E-02	4.49E-02	1.56E-01	2.34E-01	5.68E-01	9.42E-01	1.03E+00	1.03E+00	1.03E+00
Northeast	336000	16	0.82	*	*	*	*	*	*	*	*	*	*	*	*
South	305000	20	0.47	3.52E-01	5.74E-02	0.00E+00	0.00E+00	1.27E-01	1.64E-01	2.75E-01	4.83E-01	5.79E-01	1.04E+00	1.28E+00	1.28E+00
West	249000	11	0.69	*	*	*	*	*	*	*	*	*	*	*	*
<b>Responses to Questionnaire</b>															
Households who garden	1506000	78	2.21	3.90E-01	3.22E-02	0.00E+00	4.49E-02	9.43E-02	1.74E-01	2.84E-01	5.45E-01	8.36E-01	1.03E+00	1.05E+00	1.28E+00
Households who farm	304000	18	4.15	*	*	*	*	*	*	*	*	*	*	*	*

\* Intake data not provided for subpopulations for which there were less than 20 observations

NOTE: SE = standard error  
P = percentile of the distribution  
Nc wgtd = weighted number of consumers; Nc unwgtd = unweighted number of consumers in survey.  
Source: Based on EPA's analyses of the 1987-88 NFCS



Table 13-46. Consumer Only Intake of Home Produced Lima Beans (g/kg-day)

Population Group	Nc wgt'd	Nc unwt'd	% Consumin g	Mean	SE	P1	P5	P10	P25	P50	P75	P90	P95	P99	P100
Total	1917000	109	1.02	4.53E-01	4.11E-02	0.00E+00	9.19E-02	1.21E-01	1.88E-01	2.90E-01	5.45E-01	9.90E-01	1.69E+00	1.86E+00	1.91E+00
Age															
01-02	62000	3	1.09	*	*	*	*	*	*	*	*	*	*	*	*
03-05	35000	2	0.43	*	*	*	*	*	*	*	*	*	*	*	*
06-11	95000	7	0.57	*	*	*	*	*	*	*	*	*	*	*	*
12-19	108000	6	0.53	*	*	*	*	*	*	*	*	*	*	*	*
20-39	464000	20	0.75	3.84E-01	6.87E-02	3.23E-02	1.08E-01	1.30E-01	1.77E-01	2.34E-01	4.87E-01	9.37E-01	1.10E+00	1.10E+00	1.10E+00
40-69	757000	44	1.33	4.54E-01	6.30E-02	9.19E-02	1.06E-01	1.21E-01	2.04E-01	2.93E-01	5.60E-01	8.69E-01	1.71E+00	1.91E+00	1.91E+00
70 +	361000	25	2.27	5.23E-01	1.05E-01	8.20E-02	1.86E-01	1.88E-01	2.25E-01	2.86E-01	6.38E-01	1.86E+00	1.86E+00	1.86E+00	1.86E+00
Season															
Fall	375000	14	0.79	*	*	*	*	*	*	*	*	*	*	*	*
Spring	316000	39	0.68	4.19E-01	5.50E-02	8.20E-02	9.02E-02	1.31E-01	2.32E-01	3.06E-01	5.45E-01	7.48E-01	1.31E+00	1.91E+00	1.91E+00
Summer	883000	29	1.94	4.99E-01	9.68E-02	0.00E+00	9.43E-02	1.21E-01	1.72E-01	2.90E-01	4.87E-01	1.53E+00	1.71E+00	1.86E+00	1.86E+00
Winter	343000	27	0.70	5.27E-01	6.25E-02	0.00E+00	3.23E-02	1.08E-01	3.05E-01	5.39E-01	7.58E-01	8.61E-01	8.69E-01	1.69E+00	1.69E+00
Urbanization															
Central City	204000	8	0.36	*	*	*	*	*	*	*	*	*	*	*	*
Nonmetropolitan	1075000	69	2.39	2.99E-01	3.22E-02	3.23E-02	9.43E-02	1.21E-01	1.71E-01	2.12E-01	3.20E-01	4.87E-01	7.69E-01	1.69E+00	1.91E+00
Suburban	638000	32	0.74	7.53E-01	9.60E-02	0.00E+00	8.20E-02	9.19E-02	3.20E-01	6.78E-01	9.90E-01	1.71E+00	1.86E+00	1.86E+00	1.86E+00
Race															
Black	213000	9	0.98	*	*	*	*	*	*	*	*	*	*	*	*
White	1704000	100	1.08	3.83E-01	3.27E-02	0.00E+00	9.19E-02	1.08E-01	1.77E-01	2.54E-01	4.87E-01	8.61E-01	9.90E-01	1.53E+00	1.91E+00
Region															
Midwest	588000	36	1.27	4.28E-01	6.17E-02	0.00E+00	0.00E+00	1.06E-01	2.53E-01	3.06E-01	4.15E-01	9.90E-01	1.53E+00	1.69E+00	1.69E+00
Northeast	68000	6	0.17	*	*	*	*	*	*	*	*	*	*	*	*
South	1261000	67	1.96	4.72E-01	5.62E-02	3.23E-02	1.03E-01	1.30E-01	1.77E-01	2.49E-01	6.34E-01	1.10E+00	1.71E+00	1.86E+00	1.91E+00
West	0	0	0.00												
Response to Questionnaire															
Households who garden	1610000	97	2.36	4.47E-01	4.49E-02	3.23E-02	9.43E-02	1.21E-01	1.77E-01	2.85E-01	5.26E-01	9.37E-01	1.71E+00	1.86E+00	1.91E+00
Households who farm	62000	6	0.85	*	*	*	*	*	*	*	*	*	*	*	*
* Intake data not provided for subpopulations for which there were less than 20 observations															
NOTE: SE = standard error P = percentile of the distribution Nc wgt'd = weighted number of consumers; Nc unwt'd = unweighted number of consumers in survey.															
Source: Based on EPA's analyses of the 1987-88 NFCS															



Table 13-47. Consumer Only Intake of Homegrown Okra (g/kg-day)

Population Group	Nc wgtd	Nc unwgtd	% Consuming	Mean	SE	P1	P5	P10	P25	P50	P75	P90	P95	P99	P100
Total	1696000	82	0.90	3.91E-01	3.81E-02	0.00E+00	5.03E-02	9.59E-02	1.48E-01	2.99E-01	4.58E-01	7.81E-01	1.21E+00	1.53E+00	1.53E+00
<b>Age</b>															
01-02	53000	2	0.93	*	*	*	*	*	*	*	*	*	*	*	*
03-05	68000	3	0.84	*	*	*	*	*	*	*	*	*	*	*	*
06-11	218000	11	1.30	*	*	*	*	*	*	*	*	*	*	*	*
12-19	194000	9	0.95	*	*	*	*	*	*	*	*	*	*	*	*
20-39	417000	18	0.68	*	*	*	*	*	*	*	*	*	*	*	*
40-69	587000	32	1.03	4.00E-01	4.73E-02	6.57E-02	1.11E-01	1.37E-01	2.47E-01	3.07E-01	4.62E-01	7.81E-01	1.14E+00	1.14E+00	1.14E+00
70 +	130000	6	0.82	*	*	*	*	*	*	*	*	*	*	*	*
<b>Season</b>															
Fall	228000	9	0.48	*	*	*	*	*	*	*	*	*	*	*	*
Spring	236000	24	0.51	3.87E-01	6.22E-02	2.98E-02	4.58E-02	6.57E-02	1.10E-01	4.10E-01	5.95E-01	7.81E-01	9.99E-01	1.07E+00	1.07E+00
Summer	1144000	41	2.52	3.86E-01	5.75E-02	0.00E+00	5.03E-02	9.59E-02	1.44E-01	2.99E-01	4.38E-01	1.15E+00	1.53E+00	1.53E+00	1.53E+00
Winter	88000	8	0.18	*	*	*	*	*	*	*	*	*	*	*	*
<b>Urbanization</b>															
Central City	204000	6	0.36	*	*	*	*	*	*	*	*	*	*	*	*
Nonmetropolitan	1043000	55	2.32	3.65E-01	4.99E-02	0.00E+00	2.69E-02	8.48E-02	1.48E-01	2.57E-01	4.38E-01	7.81E-01	1.53E+00	1.53E+00	1.53E+00
Suburban	449000	21	0.52	5.14E-01	6.97E-02	6.57E-02	9.60E-02	1.11E-01	3.13E-01	4.62E-01	6.00E-01	1.14E+00	1.15E+00	1.15E+00	1.15E+00
<b>Race</b>															
Black	236000	13	1.09	*	*	*	*	*	*	*	*	*	*	*	*
White	1419000	68	0.90	4.26E-01	4.40E-02	0.00E+00	6.57E-02	9.60E-02	1.76E-01	3.30E-01	5.23E-01	1.14E+00	1.21E+00	1.53E+00	1.53E+00
<b>Region</b>															
Midwest	113000	7	0.24	*	*	*	*	*	*	*	*	*	*	*	*
Northeast															
South	1443000	70	2.24	3.73E-01	4.21E-02	0.00E+00	5.03E-02	8.48E-02	1.44E-01	2.59E-01	4.38E-01	7.47E-01	1.21E+00	1.53E+00	1.53E+00
West	140000	5	0.39	*	*	*	*	*	*	*	*	*	*	*	*
<b>Response to Questionnaire</b>															
Households who garden	1564000	77	2.29	3.84E-01	4.05E-02	0.00E+00	5.03E-02	9.59E-02	1.48E-01	2.98E-01	4.52E-01	1.07E+00	1.21E+00	1.53E+00	1.53E+00
Households who farm	233000	14	3.18	*	*	*	*	*	*	*	*	*	*	*	*
* Intake data not provided for subpopulations for which there were less than 20 observations															
NOTE: SE = standard error P = percentile of the distribution Nc wgtd = weighted number of consumers; Nc unwgtd = unweighted number of consumers in survey.															
Source: Based on EPA's analyses of the 1987-88 NFCS															



Table 13-48. Consumer Only Intake of Homegrown Onions (g/kg-day)

Population Group	Nc wgted	Nc unwgted	% Consuming	Mean	SE	P1	P5	P10	P25	P50	P75	P90	P95	P99	P100
Total	6718000	370	3.57	2.96E-01	1.87E-02	3.68E-03	9.09E-03	2.90E-02	8.81E-02	2.06E-01	3.77E-01	6.09E-01	9.12E-01	1.49E+00	3.11E+00
Age															
01-02	291000	17	5.11	*	*	*	*	*	*	*	*	*	*	*	*
03-05	178000	9	2.20	*	*	*	*	*	*	*	*	*	*	*	*
06-11	530000	31	3.17	3.03E-01	5.61E-02	9.80E-03	1.08E-02	2.76E-02	1.06E-01	2.28E-01	3.83E-01	6.09E-01	1.36E+00	1.36E+00	1.36E+00
12-19	652000	37	3.18	2.11E-01	3.65E-02	5.14E-03	8.36E-03	8.58E-03	5.97E-02	1.42E-01	2.55E-01	5.74E-01	7.59E-01	9.12E-01	9.12E-01
20-39	1566000	78	2.54	2.88E-01	3.40E-02	9.09E-03	3.80E-02	5.80E-02	9.40E-02	1.91E-01	3.04E-01	6.38E-01	9.35E-01	1.49E+00	1.49E+00
40-69	2402000	143	4.23	2.50E-01	2.07E-02	3.03E-03	4.59E-03	1.11E-02	7.66E-02	1.72E-01	3.58E-01	5.52E-01	6.90E-01	1.11E+00	1.41E+00
70 +	1038000	52	6.54	4.33E-01	8.86E-02	4.76E-03	6.68E-03	2.68E-02	1.35E-01	2.86E-01	4.61E-01	5.63E-01	2.68E+00	3.11E+00	3.11E+00
Season															
Fall	1557000	59	3.27	3.75E-01	6.93E-02	3.68E-03	2.55E-02	5.80E-02	1.23E-01	2.55E-01	4.36E-01	6.03E-01	7.83E-01	3.11E+00	3.11E+00
Spring	1434000	147	3.11	1.95E-01	1.96E-02	2.01E-03	5.47E-03	2.68E-02	5.73E-02	1.06E-01	2.59E-01	4.26E-01	5.23E-01	1.41E+00	1.77E+00
Summer	2891000	101	6.36	3.06E-01	2.91E-02	8.58E-03	1.68E-02	4.22E-02	1.08E-01	2.28E-01	3.76E-01	6.90E-01	9.69E-01	1.49E+00	1.49E+00
Winter	836000	63	1.72	2.88E-01	3.86E-02	3.03E-03	4.59E-03	5.04E-03	3.06E-02	1.99E-01	4.60E-01	6.42E-01	9.16E-01	1.36E+00	1.36E+00
Urbanization															
Central City	890000	37	1.58	2.16E-01	2.85E-02	4.76E-03	1.02E-02	2.55E-02	6.60E-02	1.93E-01	2.96E-01	5.18E-01	5.63E-01	5.63E-01	5.63E-01
Nonmetropolitan	2944000	177	6.54	3.24E-01	2.06E-02	8.12E-03	3.14E-02	6.75E-02	1.42E-01	2.55E-01	4.33E-01	6.30E-01	9.12E-01	1.49E+00	1.77E+00
Suburban	2884000	156	3.33	2.92E-01	3.70E-02	3.03E-03	5.20E-03	1.10E-02	5.85E-02	1.30E-01	3.56E-01	6.35E-01	9.69E-01	3.11E+00	3.11E+00
Race															
Black	253000	16	1.16	*	*	*	*	*	*	*	*	*	*	*	*
White	6266000	345	3.98	3.08E-01	1.99E-02	3.57E-03	9.09E-03	3.06E-02	9.16E-02	2.24E-01	3.86E-01	6.18E-01	9.35E-01	1.77E+00	3.11E+00
Region															
Midwest	2487000	143	5.36	2.70E-01	1.94E-02	4.25E-03	4.02E-02	5.73E-02	1.02E-01	2.24E-01	3.43E-01	5.63E-01	7.24E-01	1.34E+00	1.34E+00
Northeast	876000	52	2.13	2.32E-01	4.43E-02	2.01E-03	3.73E-03	8.36E-03	1.08E-02	1.08E-01	3.53E-01	6.35E-01	1.05E+00	1.36E+00	1.41E+00
South	1919000	107	2.98	3.32E-01	2.93E-02	4.79E-03	2.76E-02	3.70E-02	1.46E-01	2.51E-01	3.93E-01	6.90E-01	1.08E+00	1.49E+00	1.77E+00
West	1436000	68	3.98	3.32E-01	6.90E-02	3.57E-03	6.68E-03	1.68E-02	5.68E-02	1.52E-01	3.86E-01	5.49E-01	9.69E-01	3.11E+00	3.11E+00
Response to Questionnaire															
Households who garden	6441000	356	9.45	3.00E-01	1.93E-02	3.68E-03	9.09E-03	3.06E-02	9.11E-02	2.13E-01	3.81E-01	6.09E-01	9.16E-01	1.77E+00	3.11E+00
Households who farm	1390000	81	18.97	3.75E-01	3.84E-02	3.00E-02	4.04E-02	5.15E-02	1.11E-01	2.78E-01	5.15E-01	9.35E-01	1.11E+00	1.49E+00	1.49E+00

\* Intake data not provided for subpopulations for which there were less than 20 observations

NOTE: SE = standard error  
P = percentile of the distributions  
Nc wgted = weighted number of consumers; Nc unwgted = unweighted number of consumers in survey.  
Source: Based on EPA's analyses of the 1987-88 NFCS



Table 13-49. Consumer Only Intake of Homegrown Other Berries (g/kg-day)

Population Group	Nc wgtd	Nc unwtgd	% Consuming	Mean	SE	P1	P5	P10	P25	P50	P75	P90	P95	P99	P100
Total	1626000	99	0.86	4.80E-01	4.24E-02	0.00E+00	4.68E-02	9.24E-02	2.32E-01	3.84E-01	5.89E-01	1.07E+00	1.28E+00	2.21E+00	2.21E+00
Age															
01-02	41000	2	0.72	*	*	*	*	*	*	*	*	*	*	*	*
03-05	53000	3	0.65	*	*	*	*	*	*	*	*	*	*	*	*
06-11	106000	10	0.63	*	*	*	*	*	*	*	*	*	*	*	*
12-19	79000	5	0.39	*	*	*	*	*	*	*	*	*	*	*	*
20-39	309000	20	0.50	3.90E-01	6.31E-02	7.95E-02	9.18E-02	9.18E-02	1.25E-01	3.30E-01	5.52E-01	7.94E-01	1.07E+00	1.07E+00	1.07E+00
40-69	871000	51	1.54	4.89E-01	5.72E-02	7.69E-02	1.01E-01	1.34E-01	2.48E-01	3.89E-01	6.12E-01	7.68E-01	1.28E+00	2.21E+00	2.21E+00
70 +	159000	7	1.00	*	*	*	*	*	*	*	*	*	*	*	*
Season															
Fall	379000	13	0.80	*	*	*	*	*	*	*	*	*	*	*	*
Spring	287000	29	0.62	3.06E-01	4.11E-02	4.68E-02	4.68E-02	7.69E-02	1.84E-01	2.54E-01	4.08E-01	5.40E-01	7.24E-01	1.07E+00	1.07E+00
Summer	502000	18	1.10	*	*	*	*	*	*	*	*	*	*	*	*
Winter	458000	39	0.94	5.35E-01	7.39E-02	0.00E+00	1.02E-01	1.59E-01	2.32E-01	3.89E-01	6.23E-01	1.07E+00	1.95E+00	2.08E+00	2.08E+00
Urbanization															
Central City	378000	15	0.67	*	*	*	*	*	*	*	*	*	*	*	*
Nonmetropolitan	466000	37	1.04	6.43E-01	8.96E-02	0.00E+00	9.24E-02	1.02E-01	2.51E-01	4.39E-01	1.02E+00	1.31E+00	2.21E+00	2.21E+00	2.21E+00
Suburban	722000	45	0.83	4.48E-01	5.32E-02	9.18E-02	1.25E-01	1.58E-01	2.58E-01	3.84E-01	5.35E-01	5.89E-01	9.02E-01	2.08E+00	2.08E+00
Race															
Black	76000	4	0.35	*	*	*	*	*	*	*	*	*	*	*	*
White	1490000	93	0.95	5.03E-01	4.43E-02	4.68E-02	9.18E-02	1.01E-01	2.51E-01	3.95E-01	6.04E-01	1.07E+00	1.31E+00	2.21E+00	2.21E+00
Region															
Midwest	736000	56	1.59	4.57E-01	6.26E-02	0.00E+00	7.69E-02	9.18E-02	1.25E-01	3.00E-01	5.87E-01	1.12E+00	1.28E+00	2.21E+00	2.21E+00
Northeast	211000	11	0.51	*	*	*	*	*	*	*	*	*	*	*	*
South	204000	12	0.32	*	*	*	*	*	*	*	*	*	*	*	*
West	415000	18	1.15	*	*	*	*	*	*	*	*	*	*	*	*
Response to Questionnaire															
Households who garden	1333000	84	1.96	4.72E-01	4.83E-02	1.00E-02	0.00E+00	9.18E-02	2.00E-01	3.53E-01	5.52E-01	1.07E+00	1.28E+00	2.21E+00	2.21E+00
Households who farm	219000	16	2.99	*	*	*	*	*	*	*	*	*	*	*	*

\* Intake data not provided for subpopulations for which there were less than 20 observations

NOTE: SE = standard error  
P = percentile of the distribution  
Nc wgtd = weighted number of consumers; Nc unwtgd = unweighted number of consumers in survey.

Source: Based on EPA's analyses of the 1987-88 NFCS



Table 13-50. Consumer Only Intake of Homegrown Peaches (g/kg-day)

Population Group	Nc wgted	Nc unwgted	% Consuming	Mean	SE	P1	P5	P10	P25	P50	P75	P90	P95	P99	P100
Total	2941000	193	1.56	1.67E+00	1.70E-01	5.20E-02	1.65E-01	2.25E-01	4.74E-01	8.97E-01	1.88E+00	3.79E+00	6.36E+00	1.23E+01	2.23E+01
<b>Age</b>															
01-02	103000	8	1.81	*	*	*	*	*	*	*	*	*	*	*	*
03-05	65000	6	0.80	*	*	*	*	*	*	*	*	*	*	*	*
06-11	329000	26	1.97	3.11E+00	6.32E-01	9.75E-02	1.01E-01	1.40E-01	6.25E-01	1.13E+00	6.36E+00	8.53E+00	8.53E+00	1.15E+01	1.15E+01
12-19	177000	13	0.86	*	*	*	*	*	*	*	*	*	*	*	*
20-39	573000	35	0.93	1.17E+00	1.74E-01	5.07E-02	5.50E-02	2.25E-01	4.74E-01	8.09E-01	1.30E+00	2.92E+00	2.99E+00	5.27E+00	5.27E+00
40-69	1076000	70	1.90	1.53E+00	2.83E-01	5.87E-02	1.90E-01	2.39E-01	5.56E-01	8.92E-01	1.61E+00	2.63E+00	4.43E+00	1.23E+01	1.23E+01
70 +	598000	33	3.77	1.01E+00	1.97E-01	9.13E-02	1.38E-01	1.79E-01	2.82E-01	8.22E-01	1.19E+00	1.60E+00	3.79E+00	7.13E+00	7.13E+00
<b>Season</b>															
Fall	485000	19	1.02	*	*	*	*	*	*	*	*	*	*	*	*
Spring	756000	91	1.64	1.67E+00	3.04E-01	5.07E-02	5.87E-02	1.01E-01	2.76E-01	7.74E-01	1.45E+00	4.44E+00	6.77E+00	2.23E+01	2.23E+01
Summer	1081000	35	2.38	2.26E+00	4.78E-01	1.65E-01	2.25E-01	3.61E-01	5.67E-01	1.12E+00	2.99E+00	6.36E+00	8.53E+00	1.23E+01	1.23E+01
Winter	619000	48	1.27	1.25E+00	1.03E-01	3.52E-02	2.39E-01	5.56E-01	7.79E-01	1.04E+00	1.71E+00	2.35E+00	2.60E+00	3.56E+00	3.56E+00
<b>Urbanization</b>															
Central City	429000	12	0.76	*	*	*	*	*	*	*	*	*	*	*	*
Nonmetropolitan	1110000	99	2.47	1.87E+00	2.59E-01	5.87E-02	2.62E-01	3.93E-01	6.46E-01	1.02E+00	2.18E+00	3.86E+00	6.36E+00	1.15E+01	2.23E+01
Suburban	1402000	82	1.62	1.47E+00	1.75E-01	5.07E-02	1.40E-01	2.04E-01	4.61E-01	9.20E-01	1.87E+00	3.79E+00	4.43E+00	7.37E+00	7.37E+00
<b>Race</b>															
Black	39000	1	0.18	*	*	*	*	*	*	*	*	*	*	*	*
White	2861000	191	1.82	1.70E+00	1.73E-01	5.20E-02	1.65E-01	2.30E-01	5.03E-01	8.97E-01	1.96E+00	3.79E+00	6.36E+00	1.23E+01	2.23E+01
<b>Region</b>															
Midwest	824000	75	1.78	1.39E+00	2.91E-01	1.76E-01	2.20E-01	2.59E-01	4.60E-01	7.40E-01	1.19E+00	3.06E+00	3.56E+00	1.15E+01	2.23E+01
Northeast	75000	5	0.18	*	*	*	*	*	*	*	*	*	*	*	*
South	852000	51	1.32	1.67E+00	2.57E-01	3.52E-02	1.38E-01	1.79E-01	6.43E-01	1.02E+00	1.96E+00	3.83E+00	6.36E+00	8.53E+00	8.53E+00
West	1190000	62	3.30	1.80E+00	3.26E-01	5.07E-02	1.40E-01	2.25E-01	4.68E-01	8.63E-01	1.94E+00	4.43E+00	7.37E+00	1.23E+01	1.23E+01
<b>Response to Questionnaire</b>															
Households who garden	2660000	174	3.90	1.75E+00	1.85E-01	5.20E-02	1.66E-01	2.59E-01	5.26E-01	9.25E-01	1.96E+00	3.79E+00	6.36E+00	1.23E+01	2.23E+01
Households who farm	769000	54	10.49	1.56E+00	2.49E-01	6.79E-02	1.76E-01	2.26E-01	4.61E-01	9.02E-01	2.02E+00	2.99E+00	6.36E+00	8.53E+00	8.53E+00
* Intake data not provided for subpopulations for which there were less than 20 observations															
NOTE: SE = standard error P = percentile of the distribution Nc wgted = weighted number of consumers; Nc unwgted = unweighted number of consumers in survey.															
Source: Based on EPA's analyses of the 1987-88 NFCS															



Table 13-51. Consumer Only Intake of Homegrown Pears (g/kg-day)

Population Group	Nc wgtd	Nc unwgtd	% Consuming	Mean	SE	P1	P5	P10	P25	P50	P75	P90	P95	P99	P100
Total	1513000	94	0.80	9.37E-01	9.68E-02	1.01E-01	1.84E-01	2.38E-01	4.28E-01	6.82E-01	1.09E+00	1.60E+00	2.76E+00	5.16E+00	5.16E+00
<b>Age</b>															
01-02	24000	3	0.42	*	*	*	*	*	*	*	*	*	*	*	*
03-05	45000	3	0.56	*	*	*	*	*	*	*	*	*	*	*	*
06-11	145000	10	0.87	*	*	*	*	*	*	*	*	*	*	*	*
12-19	121000	7	0.59	*	*	*	*	*	*	*	*	*	*	*	*
20-39	365000	23	0.59	6.19E-01	6.42E-02	1.13E-01	3.18E-01	3.79E-01	4.28E-01	5.03E-01	6.82E-01	1.22E+00	1.24E+00	1.24E+00	1.24E+00
40-69	557000	33	0.98	6.57E-01	5.53E-02	1.01E-01	1.08E-01	3.33E-01	4.23E-01	6.45E-01	9.22E-01	1.10E+00	1.13E+00	1.51E+00	1.51E+00
70 +	256000	15	1.61	*	*	*	*	*	*	*	*	*	*	*	*
<b>Season</b>															
Fall	308000	11	0.65	*	*	*	*	*	*	*	*	*	*	*	*
Spring	355000	39	0.77	6.87E-01	7.89E-02	1.01E-01	1.13E-01	1.82E-01	3.38E-01	6.02E-01	8.66E-01	1.15E+00	1.83E+00	2.54E+00	2.54E+00
Summer	474000	16	1.04	*	*	*	*	*	*	*	*	*	*	*	*
Winter	376000	28	0.77	1.48E+00	2.77E-01	1.08E-01	1.08E-01	3.79E-01	6.45E-01	9.49E-01	1.38E+00	4.82E+00	5.16E+00	5.16E+00	5.16E+00
<b>Urbanization</b>															
Central City	222000	11	0.39	*	*	*	*	*	*	*	*	*	*	*	*
Nonmetropolitan	634000	44	1.41	7.81E-01	8.52E-02	3.33E-01	3.52E-01	4.19E-01	4.43E-01	5.70E-01	8.13E-01	1.56E+00	1.86E+00	2.88E+00	2.88E+00
Suburban	657000	39	0.76	8.50E-01	1.17E-01	1.01E-01	1.08E-01	1.82E-01	3.89E-01	7.29E-01	1.10E+00	1.50E+00	2.57E+00	4.79E+00	4.79E+00
<b>Race</b>															
Black	51000	3	0.23	*	*	*	*	*	*	*	*	*	*	*	*
White	1462000	91	0.93	9.65E-01	9.88E-02	1.08E-01	2.38E-01	3.52E-01	4.43E-01	7.01E-01	1.09E+00	1.60E+00	2.88E+00	5.16E+00	5.16E+00
<b>Region</b>															
Midwest	688000	57	1.48	8.71E-01	9.49E-02	2.22E-01	3.38E-01	3.76E-01	4.43E-01	6.45E-01	1.04E+00	1.60E+00	2.57E+00	4.79E+00	4.79E+00
Northeast	18000	2	0.04	*	*	*	*	*	*	*	*	*	*	*	*
South	377000	13	0.59	*	*	*	*	*	*	*	*	*	*	*	*
West	430000	22	1.19	1.14E+00	2.89E-01	1.01E-01	1.08E-01	1.13E-01	3.56E-01	7.52E-01	1.13E+00	2.76E+00	4.82E+00	5.16E+00	5.16E+00
<b>Response to Questionnaire</b>															
Households who garden	1312000	85	1.93	9.45E-01	1.04E-01	1.01E-01	1.82E-01	3.52E-01	4.31E-01	6.75E-01	1.09E+00	1.56E+00	2.88E+00	5.16E+00	5.16E+00
Households who farm	528000	35	7.20	1.09E+00	2.10E-01	1.08E-01	2.22E-01	3.76E-01	4.28E-01	6.14E-01	1.09E+00	2.76E+00	4.82E+00	5.16E+00	5.16E+00
* Intake data not provided for subpopulations for which there were less than 20 observations															
NOTE: SE = standard error P = percentile of the distribution Nc wgtd = weighted number of consumers; Nc unwgtd = unweighted number of consumers in survey.															
Source: Based on EPA's analyses of the 1987-88 NFCS															





Table 13-52. Consumer Only Intake of Homegrown Peas (g/kg-day)

Population Group	Nc wgtd	Nc unwtgd	% Consuming	Mean	SE	P1	P5	P10	P25	P50	P75	P90	P95	P99	P100
Total	4252000	226	2.26	5.05E-01	3.23E-02	4.58E-02	1.02E-01	1.40E-01	2.28E-01	3.21E-01	6.22E-01	1.04E+00	1.46E+00	2.66E+00	2.89E+00
<b>Age</b>															
01-02	163000	9	2.86	*	*	*	*	*	*	*	*	*	*	*	*
03-05	140000	7	1.73	*	*	*	*	*	*	*	*	*	*	*	*
06-11	515000	26	3.08	6.05E-01	8.91E-02	1.54E-01	1.54E-01	2.18E-01	3.04E-01	3.87E-01	9.00E-01	1.35E+00	1.40E+00	2.06E+00	2.06E+00
12-19	377000	22	1.84	4.08E-01	4.28E-02	5.81E-02	1.33E-01	1.58E-01	2.35E-01	3.58E-01	5.02E-01	7.10E-01	8.22E-01	8.22E-01	8.22E-01
20-39	1121000	52	1.82	4.08E-01	6.21E-02	9.96E-02	1.15E-01	1.40E-01	1.80E-01	2.54E-01	4.06E-01	8.47E-01	1.36E+00	2.71E+00	2.71E+00
40-69	1366000	80	2.41	4.58E-01	4.61E-02	6.78E-02	1.02E-01	1.20E-01	2.26E-01	3.04E-01	6.10E-01	9.95E-01	1.30E+00	2.36E+00	2.36E+00
70 +	458000	26	2.88	3.34E-01	5.58E-02	3.48E-02	3.48E-02	4.58E-02	1.84E-01	2.73E-01	3.72E-01	9.95E-01	9.95E-01	1.46E+00	1.46E+00
<b>Season</b>															
Fall	1239000	41	2.60	3.03E-01	2.97E-02	3.48E-02	4.58E-02	1.15E-01	2.09E-01	2.62E-01	3.53E-01	5.99E-01	7.14E-01	9.95E-01	9.95E-01
Spring	765000	78	1.66	4.38E-01	4.26E-02	5.81E-02	1.08E-01	1.18E-01	1.90E-01	3.26E-01	5.16E-01	9.19E-01	1.40E+00	2.06E+00	2.06E+00
Summer	1516000	51	3.33	5.85E-01	7.36E-02	6.78E-02	1.27E-01	1.74E-01	2.24E-01	3.87E-01	8.22E-01	1.35E+00	1.60E+00	2.66E+00	2.66E+00
Winter	732000	56	1.50	7.53E-01	8.86E-02	1.17E-01	1.84E-01	2.12E-01	2.73E-01	5.44E-01	9.48E-01	1.54E+00	2.36E+00	2.89E+00	2.89E+00
<b>Urbanization</b>															
Central City	558000	19	0.99	*	*	*	*	*	*	*	*	*	*	*	*
Nonmetropolitan	2028000	126	4.50	4.81E-01	3.55E-02	8.42E-02	1.36E-01	1.74E-01	2.48E-01	3.53E-01	5.79E-01	1.04E+00	1.36E+00	1.89E+00	2.89E+00
Suburban	1666000	81	1.92	5.13E-01	4.63E-02	6.78E-02	1.15E-01	1.34E-01	2.29E-01	3.87E-01	6.84E-01	9.95E-01	1.30E+00	2.28E+00	2.36E+00
<b>Race</b>															
Black	355000	19	1.63	*	*	*	*	*	*	*	*	*	*	*	*
White	3784000	203	2.40	4.95E-01	3.35E-02	3.48E-02	1.02E-01	1.33E-01	2.18E-01	3.26E-01	6.00E-01	9.99E-01	1.40E+00	2.66E+00	2.89E+00
<b>Region</b>															
Midwest	1004000	55	2.16	4.03E-01	7.24E-02	3.48E-02	4.58E-02	9.96E-02	1.40E-01	2.52E-01	3.53E-01	8.80E-01	1.54E+00	2.71E+00	2.89E+00
Northeast	241000	14	0.59	*	*	*	*	*	*	*	*	*	*	*	*
South	2449000	132	3.81	5.67E-01	4.30E-02	1.27E-01	1.74E-01	1.96E-01	2.62E-01	3.72E-01	6.82E-01	1.24E+00	1.60E+00	2.66E+00	2.66E+00
West	558000	25	1.55	3.77E-01	5.70E-02	6.78E-02	6.78E-02	1.02E-01	2.18E-01	2.73E-01	4.79E-01	9.00E-01	9.40E-01	1.40E+00	1.40E+00
<b>Response to Questionnaire</b>															
Households who garden	3980000	214	5.84	5.13E-01	3.39E-02	3.48E-02	1.02E-01	1.40E-01	2.28E-01	3.21E-01	6.28E-01	1.04E+00	1.54E+00	2.66E+00	2.89E+00
Households who farm	884000	55	12.06	4.59E-01	5.83E-02	3.48E-02	4.58E-02	8.65E-02	2.08E-01	3.53E-01	5.16E-01	9.00E-01	1.40E+00	1.60E+00	2.89E+00
* Intake data not provided for subpopulations for which there were less than 20 observations															
NOTE: SE = standard error P = percentile of the distribution Nc wgtgd = weighted number of consumers; Nc unwtgd = unweighted number of consumers in survey.															
Source: Based on EPA's analyses of the 1987-88 NFCS															



Table 13-53. Consumer Only Intake of Homegrown Peppers (g/kg-day)

Population Group	Nc wgtgd	Nc unwtgd	% Consuming	Mean	SE	P1	P5	P10	P25	P50	P75	P90	P95	P99	P100
Total	5153000	208	2.74												
<b>Age</b>															
01-02	163000	6	2.86	*	*	*	*	*	*	*	*	*	*	*	*
03-05	108000	5	1.33	*	*	*	*	*	*	*	*	*	*	*	*
06-11	578000	26	3.46	2.26E-01	4.09E-02	0.00E+00	0.00E+00	3.03E-02	8.99E-02	1.62E-01	2.98E-01	4.25E-01	7.70E-01	8.45E-01	8.45E-01
12-19	342000	16	1.67	*	*	*	*	*	*	*	*	*	*	*	*
20-39	1048000	40	1.70	2.24E-01	6.10E-02	1.74E-02	3.26E-02	5.66E-02	8.55E-02	1.19E-01	2.18E-01	3.97E-01	6.24E-01	2.48E+00	2.48E+00
40-69	2221000	88	3.92	2.50E-01	2.78E-02	5.32E-03	3.40E-02	4.52E-02	7.58E-02	1.66E-01	3.21E-01	4.77E-01	7.44E-01	1.50E+00	1.50E+00
70 +	646000	25	4.07	2.56E-01	6.22E-02	1.73E-02	2.15E-02	2.30E-02	7.47E-02	1.38E-01	2.39E-01	9.24E-01	9.39E-01	1.07E+00	1.07E+00
<b>Season</b>															
Fall	1726000	53	3.62	1.97E-01	2.51E-02	0.00E+00	3.26E-02	4.05E-02	8.55E-02	1.66E-01	2.39E-01	3.49E-01	3.97E-01	1.07E+00	1.07E+00
Spring	255000	28	0.55	2.95E-01	7.15E-02	0.00E+00	1.73E-02	3.86E-02	6.93E-02	1.47E-01	3.21E-01	1.09E+00	1.20E+00	1.53E+00	1.53E+00
Summer	2672000	94	5.87												
Winter	500000	33	1.03												
<b>Urbanization</b>															
Central City	865000	30	1.53	2.46E-01	4.23E-02	3.86E-02	5.66E-02	6.72E-02	1.10E-01	1.84E-01	2.73E-01	3.61E-01	9.39E-01	1.10E+00	1.10E+00
Nonmetropolitan	1982000	89	4.40	2.42E-01	3.93E-02	5.32E-03	2.22E-02	3.34E-02	6.93E-02	1.19E-01	2.72E-01	5.37E-01	7.70E-01	2.48E+00	2.48E+00
Suburban	2246000	87	2.59	2.47E-01	3.00E-02	0.00E+00	2.70E-02	3.50E-02	8.55E-02	1.60E-01	2.91E-01	4.90E-01	9.73E-01	1.50E+00	1.53E+00
<b>Race</b>															
Black	127000	6	0.58	*	*	*	*	*	*	*	*	*	*	*	*
White	4892000	198	3.11	2.47E-01	2.23E-02	1.74E-02	2.96E-02	4.05E-02	8.55E-02	1.54E-01	2.91E-01	4.90E-01	9.24E-01	1.81E+00	2.48E+00
<b>Region</b>															
Midwest	1790000	74	3.86	2.34E-01	4.06E-02	5.32E-03	2.22E-02	3.26E-02	5.98E-02	1.47E-01	2.57E-01	3.90E-01	8.45E-01	2.48E+00	2.48E+00
Northeast	786000	31	1.91												
South	1739000	72	2.70	2.30E-01	2.89E-02	3.34E-02	6.74E-02	7.60E-02	1.07E-01	1.66E-01	2.73E-01	4.25E-01	5.26E-01	1.81E+00	1.81E+00
West	778000	29	2.16	2.13E-01	5.04E-02	1.73E-02	2.30E-02	2.70E-02	4.05E-02	8.58E-02	2.53E-01	5.37E-01	9.24E-01	1.07E+00	1.07E+00
<b>Response to Questionnaire</b>															
Households who garden	4898000	199	7.19	2.35E-01	2.09E-02	0.00E+00	2.22E-02	3.40E-02	7.58E-02	1.54E-01	2.85E-01	4.77E-01	8.45E-01	1.50E+00	2.48E+00
Households who farm	867000	35	11.83	3.03E-01	7.50E-02	0.00E+00	2.70E-02	2.96E-02	7.11E-02	1.66E-01	3.55E-01	6.00E-01	8.45E-01	2.48E+00	2.48E+00
* Intake data not provided for subpopulations for which there were less than 20 observations															
NOTE: SE = standard error P = percentile of the distribution Nc wgtgd = weighted number of consumers; Nc unwtgd = unweighted number of consumers in survey.															
Source: Based on EPA's analyses of the 1987-88 NFCS															



Table 13-54. Consumer Only Intake of Home Produced Pork (g/kg-day)

Population Group	Nc wgtd	Nc unwgtd	% Consuming	Mean	SE	P1	P5	P10	P25	P50	P75	P90	P95	P99	P100
Total	1732000	121	0.92	1.23E+00	9.63E-02	9.26E-02	1.40E-01	3.05E-01	5.41E-01	8.96E-01	1.71E+00	2.73E+00	3.37E+00	4.93E+00	7.41E+00
Age															
01-02	38000	5	0.67	*	*	*	*	*	*	*	*	*	*	*	*
03-05	26000	3	0.32	*	*	*	*	*	*	*	*	*	*	*	*
06-11	129000	11	0.77	*	*	*	*	*	*	*	*	*	*	*	*
12-19	291000	20	1.42	1.28E+00	2.42E-01	3.05E-01	3.23E-01	3.37E-01	5.24E-01	8.85E-01	1.75E+00	3.69E+00	3.69E+00	4.29E+00	4.29E+00
20-39	511000	32	0.83	1.21E+00	1.80E-01	1.11E-01	2.83E-01	4.09E-01	5.52E-01	7.89E-01	1.43E+00	2.90E+00	3.08E+00	4.93E+00	4.93E+00
40-69	557000	38	0.98	1.02E+00	1.15E-01	1.19E-01	1.81E-01	2.22E-01	4.05E-01	8.11E-01	1.71E+00	1.78E+00	2.28E+00	3.16E+00	3.16E+00
70 +	180000	12	1.13	*	*	*	*	*	*	*	*	*	*	*	*
Season															
Fall	362000	13	0.76	*	*	*	*	*	*	*	*	*	*	*	*
Spring	547000	59	1.19	1.13E+00	1.29E-01	1.11E-01	1.40E-01	2.22E-01	3.52E-01	8.96E-01	1.50E+00	2.68E+00	3.68E+00	4.29E+00	4.29E+00
Summer	379000	15	0.83	*	*	*	*	*	*	*	*	*	*	*	*
Winter	444000	34	0.91	1.40E+00	2.39E-01	1.26E-01	2.58E-01	3.77E-01	5.03E-01	8.83E-01	2.21E+00	3.08E+00	4.93E+00	7.41E+00	7.41E+00
Urbanization															
Central City	90000	2	0.16	*	*	*	*	*	*	*	*	*	*	*	*
Nonmetropolitan	1178000	77	2.62	1.39E+00	1.31E-01	9.26E-02	2.15E-01	4.05E-01	6.17E-01	9.66E-01	1.75E+00	3.16E+00	3.69E+00	4.93E+00	7.41E+00
Suburban	464000	42	0.54	8.77E-01	1.20E-01	1.11E-01	1.19E-01	1.81E-01	3.31E-01	5.89E-01	1.10E+00	2.28E+00	2.73E+00	2.90E+00	2.90E+00
Race															
Black	0	0	0.00												
White	1732000	121	1.10	1.23E+00	9.63E-02	9.26E-02	1.40E-01	3.05E-01	5.41E-01	8.96E-01	1.71E+00	2.73E+00	3.37E+00	4.93E+00	7.41E+00
Region															
Midwest	844000	64	1.82	1.06E+00	1.19E-01	9.26E-02	1.19E-01	2.13E-01	5.02E-01	6.72E-01	1.20E+00	2.68E+00	3.37E+00	3.69E+00	3.73E+00
Northeast	97000	5	0.24	*	*	*	*	*	*	*	*	*	*	*	*
South	554000	32	0.86	1.35E+00	1.46E-01	1.81E-01	2.58E-01	3.37E-01	8.11E-01	1.26E+00	1.75E+00	2.44E+00	3.08E+00	4.29E+00	4.29E+00
West	237000	20	0.66	1.15E+00	3.09E-01	1.26E-01	3.23E-01	3.77E-01	4.40E-01	7.29E-01	1.10E+00	1.75E+00	2.73E+00	7.41E+00	7.41E+00
Response to Questionnaire															
Households who raise animals	1428000	100	14.14	1.34E+00	9.86E-02	1.40E-01	3.23E-01	4.05E-01	5.89E-01	9.66E-01	1.75E+00	2.90E+00	3.37E+00	4.29E+00	4.93E+00
Households who farm	1218000	82	16.62	1.30E+00	1.11E-01	2.15E-01	3.42E-01	4.08E-01	5.85E-01	9.24E-01	1.71E+00	3.08E+00	3.69E+00	4.93E+00	4.93E+00
* Intake data not provided for subpopulations for which there were less than 20 observations															
NOTE: SE = standard error P = percentile of the distribution Nc wgtd = weighted number of consumers; Nc unwgtd = unweighted number of consumers in survey.															
Source: Based on EPA's analyses of the 1987-88 NFCS															



Table 13-55. Consumer Only Intake of Home Produced Poultry (g/kg-day)

Population Group	Nc wgtd	Nc unwgtd	% Consuming	Mean	SE	P1	P5	P10	P25	P50	P75	P90	P95	P99	P100
Total	1816000	105	0.97	1.57E+00	1.15E-01	1.95E-01	3.03E-01	4.18E-01	6.37E-01	1.23E+00	2.19E+00	3.17E+00	3.83E+00	5.33E+00	6.17E+00
<b>Age</b>															
01-02	91000	8	1.60	*	*	*	*	*	*	*	*	*	*	*	*
03-05	70000	5	0.86	*	*	*	*	*	*	*	*	*	*	*	*
06-11	205000	12	1.23	*	*	*	*	*	*	*	*	*	*	*	*
12-19	194000	12	0.95	*	*	*	*	*	*	*	*	*	*	*	*
20-39	574000	33	0.93	1.17E+00	1.47E-01	1.73E-01	4.02E-01	4.02E-01	5.57E-01	1.15E+00	1.37E+00	1.80E+00	2.93E+00	4.59E+00	4.59E+00
40-69	568000	30	1.00	1.51E+00	2.43E-01	1.95E-01	1.97E-01	3.03E-01	4.91E-01	7.74E-01	2.69E+00	3.29E+00	4.60E+00	5.15E+00	5.15E+00
70 +	80000	3	0.50	*	*	*	*	*	*	*	*	*	*	*	*
<b>Season</b>															
Fall	562000	23	1.18	1.52E+00	1.75E-01	4.07E-01	4.18E-01	4.60E-01	8.11E-01	1.39E+00	2.23E+00	2.69E+00	3.17E+00	3.17E+00	3.17E+00
Spring	374000	34	0.81	1.87E+00	2.79E-01	1.73E-01	2.28E-01	3.03E-01	5.22E-01	1.38E+00	3.29E+00	4.60E+00	5.15E+00	5.33E+00	5.33E+00
Summer	312000	11	0.69	*	*	*	*	*	*	*	*	*	*	*	*
Winter	568000	37	1.17	1.55E+00	2.00E-01	1.95E-01	1.97E-01	4.33E-01	5.95E-01	1.23E+00	2.18E+00	2.95E+00	3.47E+00	6.17E+00	6.17E+00
<b>Urbanization</b>															
Central City	230000	8	0.41	*	*	*	*	*	*	*	*	*	*	*	*
Nonmetropolitan	997000	56	2.21	1.48E+00	1.32E-01	1.95E-01	2.82E-01	4.07E-01	6.72E-01	1.19E+00	2.10E+00	3.17E+00	3.29E+00	3.86E+00	5.33E+00
Suburban	589000	41	0.68	1.94E+00	2.30E-01	2.28E-01	2.67E-01	4.33E-01	6.24E-01	1.59E+00	2.69E+00	4.59E+00	4.83E+00	6.17E+00	6.17E+00
<b>Race</b>															
Black	44000	2	0.20	*	*	*	*	*	*	*	*	*	*	*	*
White	1772000	103	1.12	1.57E+00	1.17E-01	1.95E-01	3.03E-01	4.18E-01	6.24E-01	1.23E+00	2.19E+00	3.17E+00	3.86E+00	5.33E+00	6.17E+00
<b>Region</b>															
Midwest	765000	41	1.65	1.60E+00	1.40E-01	4.07E-01	4.18E-01	5.57E-01	9.79E-01	1.39E+00	2.19E+00	2.70E+00	3.17E+00	3.86E+00	5.33E+00
Northeast	64000	4	0.16	*	*	*	*	*	*	*	*	*	*	*	*
South	654000	38	1.02	1.67E+00	2.50E-01	1.73E-01	1.97E-01	3.03E-01	4.60E-01	9.08E-01	2.11E+00	4.59E+00	4.83E+00	6.17E+00	6.17E+00
West	333000	22	0.92	1.24E+00	1.80E-01	2.67E-01	2.67E-01	4.27E-01	5.60E-01	1.02E+00	1.89E+00	2.45E+00	2.93E+00	2.93E+00	2.93E+00
<b>Response to Questionnaire</b>															
Households who raise animals	1333000	81	13.20	1.58E+00	1.18E-01	2.28E-01	4.07E-01	4.72E-01	7.09E-01	1.37E+00	2.19E+00	2.93E+00	3.29E+00	5.33E+00	6.17E+00
Households who farm	917000	59	12.51	1.54E+00	1.79E-01	1.95E-01	2.28E-01	3.03E-01	5.95E-01	1.06E+00	2.18E+00	3.47E+00	4.83E+00	6.17E+00	6.17E+00
* Intake data not provided for subpopulations for which there were less than 20 observations															
NOTE: SE = standard error P = percentile of the distribution Nc wgtd = weighted number of consumers; Nc unwgtd = unweighted number of consumers in survey. Source: Based on EPA's analyses of the 1987-88 NFCS															



Table 13-56. Consumer Only Intake of Homegrown Pumpkins (g/kg-day)

Population Group	Nc wgtd	Nc unwtgd	% Consuming	Mean	SE	P1	P5	P10	P25	P50	P75	P90	P95	P99	P100
Total	2041000	87	1.09	7.78E-01	6.83E-02	1.25E-01	1.84E-01	2.41E-01	3.18E-01	5.55E-01	1.07E+00	1.47E+00	1.79E+00	3.02E+00	4.48E+00
<b>Age</b>															
01-02	73000	4	1.28	*	*	*	*	*	*	*	*	*	*	*	*
03-05	18000	2	0.22	*	*	*	*	*	*	*	*	*	*	*	*
06-11	229000	9	1.37	*	*	*	*	*	*	*	*	*	*	*	*
12-19	244000	10	1.19	*	*	*	*	*	*	*	*	*	*	*	*
20-39	657000	26	1.07	8.01E-01	1.29E-01	1.76E-01	1.84E-01	3.01E-01	3.77E-01	4.77E-01	1.03E+00	1.73E+00	2.67E+00	2.67E+00	2.67E+00
40-69	415000	20	0.73	8.22E-01	1.57E-01	2.86E-01	2.86E-01	3.16E-01	3.71E-01	5.23E-01	9.62E-01	1.47E+00	3.02E+00	3.02E+00	3.02E+00
70 +	373000	15	2.35	*	*	*	*	*	*	*	*	*	*	*	*
<b>Season</b>															
Fall	1345000	49	2.82	8.19E-01	8.91E-02	1.25E-01	1.76E-01	2.81E-01	3.71E-01	6.14E-01	1.17E+00	1.73E+00	1.79E+00	3.02E+00	3.02E+00
Spring	48000	6	0.10	*	*	*	*	*	*	*	*	*	*	*	*
Summer	405000	13	0.89	*	*	*	*	*	*	*	*	*	*	*	*
Winter	243000	19	0.50	*	*	*	*	*	*	*	*	*	*	*	*
<b>Urbanization</b>															
Central City	565000	20	1.00	6.29E-01	1.08E-01	1.84E-01	1.84E-01	2.41E-01	2.81E-01	3.77E-01	9.40E-01	1.24E+00	1.33E+00	2.24E+00	2.24E+00
Nonmetropolitan	863000	44	1.92	6.44E-01	9.64E-02	1.25E-01	1.65E-01	1.89E-01	3.10E-01	5.10E-01	6.65E-01	1.22E+00	1.45E+00	4.48E+00	4.48E+00
Suburban	613000	23	0.71	1.10E+00	1.34E-01	2.86E-01	2.88E-01	3.01E-01	4.67E-01	1.04E+00	1.47E+00	1.79E+00	2.67E+00	2.67E+00	2.67E+00
<b>Race</b>															
Black	22000	1	0.10	*	*	*	*	*	*	*	*	*	*	*	*
White	2019000	86	1.28	7.82E-01	6.90E-02	1.25E-01	1.84E-01	2.41E-01	3.16E-01	5.55E-01	1.10E+00	1.47E+00	1.79E+00	3.02E+00	4.48E+00
<b>Region</b>															
Midwest	1370000	54	2.95	8.21E-01	9.68E-02	1.25E-01	2.34E-01	2.41E-01	3.18E-01	5.72E-01	1.04E+00	1.73E+00	2.67E+00	3.02E+00	4.48E+00
Northeast	15000	1	0.04	*	*	*	*	*	*	*	*	*	*	*	*
South	179000	10	0.28	*	*	*	*	*	*	*	*	*	*	*	*
West	477000	22	1.32	7.87E-01	9.65E-02	1.76E-01	1.89E-01	3.08E-01	3.71E-01	7.44E-01	1.17E+00	1.47E+00	1.51E+00	1.51E+00	1.51E+00
<b>Response to Questionnaire</b>															
Households who garden	1987000	85	2.92	7.70E-01	6.93E-02	1.25E-01	1.84E-01	2.41E-01	3.16E-01	5.55E-01	1.04E+00	1.46E+00	1.79E+00	3.02E+00	4.48E+00
Households who farm	449000	18	6.13	*	*	*	*	*	*	*	*	*	*	*	*
* Intake data not provided for subpopulations for which there were less than 20 observations															
NOTE: SE = standard error P = percentile of the distribution Nc wgtd = weighted number of consumers; Nc unwtgd = unweighted number of consumers in survey.															
Source: Based on EPA's analyses of the 1987-88 NFCS															



Table 13-57. Consumer Only Intake of Homegrown Snap Beans (g/kg-day)

Population Group	Nc wgtd	Nc unwgtd	% Consuming	Mean	SE	P1	P5	P10	P25	P50	P75	P90	P95	P99	P100
Total	12308000	739	6.55	8.00E-01	3.02E-02	5.65E-02	1.49E-01	1.88E-01	3.38E-01	5.69E-01	1.04E+00	1.58E+00	2.01E+00	3.90E+00	9.96E+00
Age															
01-02	246000	17	4.32	*	*	*	*	*	*	*	*	*	*	*	*
03-05	455000	32	5.62	1.49E+00	2.37E-01	0.00E+00	0.00E+00	3.49E-01	9.01E-01	1.16E+00	1.66E+00	3.20E+00	4.88E+00	6.90E+00	6.90E+00
06-11	862000	62	5.16	8.97E-01	1.15E-01	0.00E+00	1.99E-01	2.21E-01	3.21E-01	6.42E-01	1.21E+00	1.79E+00	2.75E+00	4.81E+00	5.66E+00
12-19	1151000	69	5.62	6.38E-01	6.10E-02	0.00E+00	1.61E-01	2.22E-01	3.20E-01	5.04E-01	8.11E-01	1.34E+00	1.79E+00	2.72E+00	2.72E+00
20-39	2677000	160	4.35	6.13E-01	4.09E-02	7.05E-02	1.31E-01	1.57E-01	2.60E-01	4.96E-01	7.85E-01	1.24E+00	1.64E+00	2.05E+00	4.26E+00
40-69	4987000	292	8.79	7.19E-01	3.20E-02	9.99E-02	1.61E-01	2.28E-01	3.62E-01	5.61E-01	8.59E-01	1.45E+00	1.77E+00	2.70E+00	4.23E+00
70 +	1801000	100	11.34	9.15E-01	1.16E-01	5.65E-02	7.44E-02	1.51E-01	3.69E-01	6.38E-01	1.22E+00	1.70E+00	2.01E+00	9.96E+00	9.96E+00
Season															
Fall	3813000	137	8.00	8.12E-01	8.19E-02	5.65E-02	1.50E-01	1.83E-01	2.72E-01	5.39E-01	1.18E+00	1.52E+00	2.01E+00	4.82E+00	9.96E+00
Spring	2706000	288	5.86	9.00E-01	5.44E-02	2.93E-02	1.51E-01	2.19E-01	3.70E-01	5.91E-01	1.11E+00	1.72E+00	2.85E+00	5.66E+00	6.90E+00
Summer	2946000	98	6.48	6.33E-01	4.81E-02	0.00E+00	1.18E-01	1.57E-01	3.31E-01	5.04E-01	8.50E-01	1.30E+00	1.70E+00	2.05E+00	2.63E+00
Winter	2843000	216	5.84	8.64E-01	5.28E-02	1.14E-01	1.80E-01	2.44E-01	4.24E-01	6.20E-01	1.12E+00	1.72E+00	2.02E+00	3.85E+00	7.88E+00
Urbanization															
Central City	2205000	78	3.91	5.97E-01	5.59E-02	5.65E-02	7.44E-02	1.59E-01	2.56E-01	5.12E-01	7.12E-01	1.23E+00	1.54E+00	1.93E+00	3.35E+00
Nonmetropolitan	5696000	404	12.65	9.61E-01	5.06E-02	9.35E-02	1.77E-01	2.29E-01	3.67E-01	6.75E-01	1.19E+00	1.89E+00	2.70E+00	4.88E+00	9.96E+00
Suburban	4347000	255	5.02	7.04E-01	3.76E-02	9.67E-02	1.39E-01	1.88E-01	3.41E-01	5.20E-01	9.32E-01	1.36E+00	1.77E+00	2.98E+00	6.08E+00
Race															
Black	634000	36	2.92	7.55E-01	1.43E-01	2.51E-01	2.51E-01	2.79E-01	2.99E-01	4.78E-01	1.04E+00	1.30E+00	1.34E+00	5.98E+00	5.98E+00
White	11519000	694	7.31	8.10E-01	3.12E-02	7.05E-02	1.50E-01	1.89E-01	3.49E-01	5.73E-01	1.06E+00	1.63E+00	2.01E+00	3.90E+00	9.96E+00
Region															
Midwest	4651000	307	10.02	8.60E-01	6.11E-02	7.44E-02	1.54E-01	1.89E-01	3.36E-01	5.50E-01	9.88E-01	1.70E+00	2.47E+00	4.88E+00	9.96E+00
Northeast	990000	52	2.40	5.66E-01	6.63E-02	0.00E+00	9.66E-02	1.06E-01	1.81E-01	4.91E-01	8.15E-01	1.28E+00	1.36E+00	1.97E+00	3.09E+00
South	4755000	286	7.39	8.82E-01	4.04E-02	1.33E-01	2.13E-01	2.51E-01	3.98E-01	6.75E-01	1.22E+00	1.72E+00	2.01E+00	3.23E+00	5.98E+00
West	1852000	92	5.14	5.92E-01	4.35E-02	7.05E-02	1.43E-01	1.83E-01	2.72E-01	5.14E-01	7.41E-01	1.20E+00	1.52E+00	2.19E+00	2.19E+00
Response to Questionnaire															
Households who garden	11843000	700	17.38	7.90E-01	3.08E-02	5.65E-02	1.49E-01	1.87E-01	3.31E-01	5.63E-01	1.02E+00	1.60E+00	2.01E+00	3.85E+00	9.96E+00
Households who farm	2591000	157	35.35	7.95E-01	4.78E-02	5.65E-02	1.27E-01	1.89E-01	4.05E-01	6.59E-01	1.12E+00	1.54E+00	1.98E+00	2.96E+00	4.23E+00
* Intake data not provided for subpopulations for which there were less than 20 observations															
NOTE: SE = standard error P = percentile of the distribution Nc wgtd = weighted number of consumers; Nc unwgtd = unweighted number of consumers in survey.															
Source: Based on EPA's analyses of the 1987-88 NFCS															



Table 13-58. Consumer Only Intake of Homegrown Strawberries (g/kg-day)

Population Group	Nc wgted	Nc unwtgd	% Consuming	Mean	SE	P1	P5	P10	P25	P50	P75	P90	P95	P99	P100
Total	2057000	139	1.09	6.52E-01	5.15E-02	4.15E-02	8.16E-02	1.18E-01	2.55E-01	4.67E-01	8.20E-01	1.47E+00	1.77E+00	2.72E+00	4.83E+00
<b>Age</b>															
01-02	30000	2	0.53	*	*	*	*	*	*	*	*	*	*	*	*
03-05	66000	6	0.81	*	*	*	*	*	*	*	*	*	*	*	*
06-11	153000	15	0.92	*	*	*	*	*	*	*	*	*	*	*	*
12-19	201000	11	0.98	*	*	*	*	*	*	*	*	*	*	*	*
20-39	316000	22	0.51	3.21E-01	6.41E-02	7.92E-02	8.16E-02	1.05E-01	1.18E-01	2.05E-01	4.59E-01	8.20E-01	9.73E-01	1.56E+00	1.56E+00
40-69	833000	55	1.47	6.44E-01	6.37E-02	2.44E-02	6.53E-02	1.75E-01	3.55E-01	5.83E-01	9.41E-01	1.42E+00	1.47E+00	2.37E+00	2.37E+00
70 +	449000	27	2.83	6.36E-01	1.11E-01	4.15E-02	4.41E-02	8.64E-02	2.62E-01	4.69E-01	7.00E-01	1.66E+00	1.89E+00	2.72E+00	2.72E+00
<b>Season</b>															
Fall	250000	8	0.52	*	*	*	*	*	*	*	*	*	*	*	*
Spring	598000	66	1.30	8.30E-01	1.03E-01	7.92E-02	8.92E-02	1.80E-01	2.75E-01	4.69E-01	9.73E-01	1.93E+00	2.54E+00	4.83E+00	4.83E+00
Summer	388000	11	0.85	*	*	*	*	*	*	*	*	*	*	*	*
Winter	821000	54	1.69	5.13E-01	6.42E-02	2.44E-02	4.41E-02	1.05E-01	2.07E-01	3.86E-01	6.01E-01	1.27E+00	1.46E+00	2.37E+00	2.37E+00
<b>Urbanization</b>															
Central City	505000	23	0.90	7.54E-01	1.22E-01	4.15E-02	4.41E-02	8.92E-02	3.82E-01	4.88E-01	1.33E+00	1.47E+00	1.69E+00	2.37E+00	2.37E+00
Nonmetropolitan	664000	52	1.47	6.18E-01	1.05E-01	2.44E-02	6.53E-02	8.16E-02	1.25E-01	3.85E-01	8.14E-01	1.66E+00	2.16E+00	4.83E+00	4.83E+00
Suburban	888000	64	1.03	6.20E-01	5.88E-02	7.92E-02	1.81E-01	2.21E-01	3.45E-01	5.30E-01	6.96E-01	1.27E+00	1.56E+00	2.97E+00	2.97E+00
<b>Race</b>															
Black	0	0	0.00												
White	2057000	139	1.31	6.52E-01	5.15E-02	4.15E-02	8.16E-02	1.18E-01	2.55E-01	4.67E-01	8.20E-01	1.47E+00	1.77E+00	2.72E+00	4.83E+00
<b>Region</b>															
Midwest	1123000	76	2.42	6.85E-01	8.28E-02	2.44E-02	6.53E-02	8.16E-02	1.82E-01	4.16E-01	1.00E+00	1.66E+00	1.93E+00	2.97E+00	4.83E+00
Northeast	382000	25	0.93	6.35E-01	1.01E-01	8.92E-02	1.59E-01	1.82E-01	2.55E-01	4.67E-01	8.65E-01	1.46E+00	1.83E+00	2.16E+00	2.16E+00
South	333000	23	0.52	6.69E-01	8.41E-02	1.33E-01	2.05E-01	3.77E-01	5.15E-01	6.21E-01	6.96E-01	1.00E+00	1.00E+00	2.72E+00	2.72E+00
West	219000	15	0.61	*	*	*	*	*	*	*	*	*	*	*	*
<b>Response to Questionnaire</b>															
Households who garden	1843000	123	2.70	6.37E-01	5.48E-02	4.15E-02	7.92E-02	1.18E-01	2.28E-01	4.53E-01	8.20E-01	1.46E+00	1.77E+00	2.54E+00	4.83E+00
Households who farm	87000	9	1.19	*	*	*	*	*	*	*	*	*	*	*	*
* Intake data not provided for subpopulations for which there were less than 20 observations															
NOTE: SE = standard error P = percentile of the distribution Nc wgted = weighted number of consumers; Nc unwtgd = unweighted number of consumers in survey. Source: Based on EPA's analyses of the 1987-88 NFCS															



Table 13-59. Consumer Only Intake of Homegrown Tomatoes (g/kg-day)

Population Group	Nc wgt'd	Nc unwt'd	% Consuming	Mean	SE	P1	P5	P10	P25	P50	P75	P90	P95	P99	P100
Total	16737000	743	8.90	1.18E+00	5.26E-02	7.57E-02	1.52E-01	2.34E-01	3.92E-01	7.43E-01	1.46E+00	2.50E+00	3.54E+00	7.26E+00	1.93E+01
<b>Age</b>															
01-02	572000	26	10.04	3.14E+00	5.30E-01	7.26E-01	8.55E-01	9.34E-01	1.23E+00	1.66E+00	4.00E+00	7.26E+00	1.07E+01	1.07E+01	1.07E+01
03-05	516000	26	6.37	1.61E+00	2.65E-01	4.96E-01	5.07E-01	5.07E-01	7.54E-01	1.25E+00	1.65E+00	3.00E+00	6.25E+00	6.25E+00	6.25E+00
06-11	1093000	51	6.54	1.63E+00	2.68E-01	2.17E-01	3.10E-01	3.92E-01	5.30E-01	7.55E-01	1.66E+00	5.20E+00	5.70E+00	9.14E+00	9.14E+00
12-19	1411000	61	6.89	7.15E-01	8.52E-02	0.00E+00	0.00E+00	1.82E-01	2.68E-01	5.21E-01	8.50E-01	1.67E+00	1.94E+00	3.39E+00	3.39E+00
20-39	4169000	175	6.77	8.54E-01	1.03E-01	7.32E-02	1.31E-01	1.47E-01	2.54E-01	5.15E-01	1.00E+00	1.83E+00	2.10E+00	5.52E+00	1.93E+01
40-69	6758000	305	11.92	1.05E+00	5.23E-02	1.13E-01	1.73E-01	2.81E-01	3.97E-01	7.46E-01	1.41E+00	2.40E+00	3.05E+00	4.50E+00	5.00E+00
70 +	1989000	89	12.53	1.26E+00	9.40E-02	1.13E-01	2.36E-01	2.98E-01	4.82E-01	1.14E+00	1.77E+00	2.51E+00	2.99E+00	3.67E+00	3.67E+00
<b>Season</b>															
Fall	5516000	201	11.57	1.02E+00	8.55E-02	7.32E-02	1.35E-01	2.23E-01	3.43E-01	5.95E-01	1.34E+00	2.24E+00	2.87E+00	6.25E+00	1.07E+01
Spring	1264000	127	2.74	8.39E-01	6.26E-02	1.36E-01	1.89E-01	2.39E-01	3.73E-01	6.31E-01	1.11E+00	1.75E+00	2.00E+00	3.79E+00	5.28E+00
Summer	8122000	279	17.86	1.30E+00	8.75E-02	1.05E-01	1.66E-01	2.36E-01	4.08E-01	8.03E-01	1.55E+00	3.05E+00	4.05E+00	7.26E+00	1.09E+01
Winter	1835000	136	3.77	1.37E+00	1.77E-01	9.07E-02	2.07E-01	2.85E-01	4.97E-01	8.29E-01	1.49E+00	2.48E+00	3.38E+00	8.29E+00	1.93E+01
<b>Urbanization</b>															
Central City	2680000	90	4.76	1.10E+00	1.27E-01	0.00E+00	1.52E-01	2.25E-01	3.54E-01	7.54E-01	1.51E+00	2.16E+00	2.95E+00	7.26E+00	8.29E+00
Nonmetropolitan	7389000	378	16.41	1.26E+00	7.35E-02	1.13E-01	2.16E-01	2.62E-01	4.23E-01	7.62E-01	1.47E+00	2.77E+00	3.85E+00	6.87E+00	1.07E+01
Suburban	6668000	275	7.70	1.13E+00	9.14E-02	7.57E-02	1.35E-01	1.78E-01	3.70E-01	6.68E-01	1.38E+00	2.35E+00	3.32E+00	5.52E+00	1.93E+01
<b>Race</b>															
Black	743000	28	3.42	6.14E-01	8.60E-02	0.00E+00	0.00E+00	7.32E-02	2.36E-01	5.07E-01	9.02E-01	1.18E+00	1.55E+00	1.66E+00	1.66E+00
White	15658000	703	9.94	1.22E+00	5.54E-02	1.05E-01	1.68E-01	2.41E-01	4.06E-01	7.55E-01	1.49E+00	2.55E+00	3.59E+00	7.26E+00	1.93E+01
<b>Region</b>															
Midwest	6747000	322	14.54	1.18E+00	8.91E-02	6.34E-02	1.45E-01	2.06E-01	3.62E-01	6.82E-01	1.41E+00	2.51E+00	3.69E+00	6.87E+00	1.93E+01
Northeast	2480000	87	6.02	1.17E+00	1.64E-01	7.57E-02	1.35E-01	1.48E-01	3.50E-01	7.51E-01	1.38E+00	2.44E+00	3.52E+00	1.09E+01	1.09E+01
South	4358000	202	6.77	1.15E+00	9.07E-02	0.00E+00	2.07E-01	2.53E-01	4.23E-01	7.46E-01	1.43E+00	2.32E+00	3.67E+00	6.82E+00	9.14E+00
West	3152000	132	8.74	1.23E+00	9.90E-02	1.80E-01	2.39E-01	2.84E-01	4.11E-01	7.65E-01	1.84E+00	2.78E+00	3.08E+00	7.26E+00	7.26E+00
<b>Response to Questionnaire</b>															
Households who garden	14791000	661	21.70	1.21E+00	5.70E-02	7.57E-02	1.52E-01	2.34E-01	4.06E-01	7.58E-01	1.50E+00	2.51E+00	3.52E+00	7.26E+00	1.93E+01
Households who farm	2269000	112	30.96	1.42E+00	1.58E-01	0.00E+00	1.80E-01	2.26E-01	4.23E-01	7.66E-01	1.86E+00	3.55E+00	5.20E+00	9.14E+00	9.14E+00

NOTE: SE = standard error  
P = percentile of the distribution  
Nc wgt'd = weighted number of consumers; Nc unwt'd = unweighted number of consumers in survey.  
Source: Based on EPA's analyses of the 1987-88 NFCS





Table 13-60. Consumer Only Intake of Homegrown White Potatoes (g/kg-day)

Population Group	Nc wgtd	Nc unwgtd	% Consuming	Mean	SE	P1	P5	P10	P25	P50	P75	P90	P95	P99	P100
Total	5895000	281	3.14	1.66E+00	1.05E-01	0.00E+00	1.87E-01	3.08E-01	5.50E-01	1.27E+00	2.07E+00	3.11E+00	4.76E+00	9.52E+00	1.28E+01
<b>Age</b>															
01-02	147000	10	2.58	*	*	*	*	*	*	*	*	*	*	*	*
03-05	119000	6	1.47	*	*	*	*	*	*	*	*	*	*	*	*
06-11	431000	24	2.58	2.19E+00	3.85E-01	0.00E+00	0.00E+00	4.10E-01	7.20E-01	1.76E+00	3.10E+00	5.94E+00	6.52E+00	6.52E+00	6.52E+00
12-19	751000	31	3.67	1.26E+00	1.85E-01	6.67E-02	1.87E-01	2.59E-01	3.84E-01	1.22E+00	1.80E+00	2.95E+00	3.11E+00	4.14E+00	4.14E+00
20-39	1501000	66	2.44	1.24E+00	1.21E-01	1.64E-01	1.64E-01	1.96E-01	4.77E-01	1.00E+00	1.62E+00	2.54E+00	3.08E+00	4.29E+00	5.09E+00
40-69	1855000	95	3.27	1.86E+00	2.29E-01	1.27E-01	2.62E-01	3.50E-01	6.99E-01	1.31E+00	2.04E+00	3.43E+00	5.29E+00	1.28E+01	1.28E+01
70 +	1021000	45	6.43	1.27E+00	1.22E-01	2.06E-01	2.17E-01	3.57E-01	5.50E-01	1.21E+00	1.69E+00	2.35E+00	2.88E+00	3.92E+00	3.92E+00
<b>Season</b>															
Fall	2267000	86	4.76	1.63E+00	2.23E-01	1.64E-01	2.23E-01	2.65E-01	4.61E-01	1.13E+00	1.79E+00	3.43E+00	4.14E+00	1.28E+01	1.28E+01
Spring	527000	58	1.14	1.23E+00	1.28E-01	6.67E-02	1.05E-01	1.96E-01	4.10E-01	8.55E-01	1.91E+00	2.86E+00	3.08E+00	4.28E+00	4.28E+00
Summer	2403000	81	5.28	1.63E+00	1.82E-01	0.00E+00	1.87E-01	3.19E-01	6.20E-01	1.32E+00	2.09E+00	3.08E+00	5.29E+00	9.43E+00	9.43E+00
Winter	698000	56	1.43	2.17E+00	1.98E-01	1.41E-01	3.95E-01	4.97E-01	8.64E-01	2.02E+00	2.95E+00	4.26E+00	5.40E+00	6.00E+00	6.00E+00
<b>Urbanization</b>															
Central City	679000	25	1.20	9.60E-01	1.51E-01	1.64E-01	1.64E-01	1.75E-01	3.75E-01	5.55E-01	1.52E+00	2.07E+00	2.25E+00	2.54E+00	2.54E+00
Nonmetropolitan	3046000	159	6.77	1.96E+00	1.55E-01	1.84E-01	2.65E-01	3.68E-01	7.67E-01	1.50E+00	2.38E+00	3.55E+00	5.64E+00	1.28E+01	1.28E+01
Suburban	2110000	95	2.44	1.49E+00	1.67E-01	1.05E-01	1.87E-01	3.19E-01	5.40E-01	9.29E-01	1.68E+00	3.11E+00	4.76E+00	9.43E+00	9.43E+00
<b>Race</b>															
Black	140000	5	0.64	*	*	*	*	*	*	*	*	*	*	*	*
White	5550000	269	3.52	1.67E+00	1.09E-01	1.41E-01	2.06E-01	3.08E-01	5.50E-01	1.28E+00	2.09E+00	3.11E+00	4.76E+00	9.52E+00	1.28E+01
<b>Region</b>															
Midwest	2587000	133	5.58	1.77E+00	1.47E-01	1.75E-01	2.36E-01	3.39E-01	6.41E-01	1.35E+00	2.15E+00	3.77E+00	5.29E+00	9.43E+00	9.43E+00
Northeast	656000	31	1.59	1.28E+00	2.04E-01	6.67E-02	1.27E-01	1.67E-01	3.48E-01	8.64E-01	1.97E+00	2.95E+00	3.80E+00	5.09E+00	5.09E+00
South	1796000	84	2.79	2.08E+00	2.39E-01	1.64E-01	3.50E-01	4.61E-01	9.24E-01	1.56E+00	2.40E+00	3.44E+00	5.64E+00	1.28E+01	1.28E+01
West	796000	31	2.21	7.61E-01	1.05E-01	1.64E-01	2.16E-01	2.59E-01	4.11E-01	5.43E-01	9.63E-01	1.40E+00	1.95E+00	3.11E+00	3.11E+00
<b>Response to Questionnaire</b>															
Households who garden	5291000	250	7.76	1.65E+00	1.09E-01	0.00E+00	2.06E-01	3.08E-01	5.55E-01	1.28E+00	2.09E+00	3.10E+00	4.28E+00	9.52E+00	1.28E+01
Households who farm	1082000	62	14.76	1.83E+00	1.78E-01	6.67E-02	2.06E-01	5.76E-01	9.24E-01	1.46E+00	2.31E+00	3.80E+00	5.09E+00	6.52E+00	6.52E+00
* Intake data not provided for subpopulations for which there were less than 20 observations															
NOTE: SE = standard error P = percentile of the distribution Nc wgtd = weighted number of consumers; Nc unwgtd = unweighted number of consumers in survey.															
Source: Based on EPA's analyses of the 1987-88 NFCS															



Table 13-61. Consumer Only Intake of Homegrown Exposed Fruit (g/kg-day)

Population Group	Nc wgtd	Nc unwgtd	% Consuming	Mean	SE	P1	P5	P10	P25	P50	P75	P90	P95	P99	P100
Total	11770000	679	6.26	1.49E+00	8.13E-02	4.41E-02	1.37E-01	2.55E-01	4.46E-01	8.33E-01	1.70E+00	3.16E+00	4.78E+00	1.20E+01	3.25E+01
<b>Age</b>															
01-02	306000	19	5.37	*	*	*	*	*	*	*	*	*	*	*	*
03-05	470000	30	5.80	2.60E+00	7.78E-01	0.00E+00	0.00E+00	3.73E-01	1.00E+00	1.82E+00	2.64E+00	5.41E+00	6.07E+00	3.25E+01	3.25E+01
06-11	915000	68	5.48	2.52E+00	4.24E-01	0.00E+00	1.71E-01	3.73E-01	6.19E-01	1.11E+00	2.91E+00	6.98E+00	1.17E+01	1.57E+01	1.59E+01
12-19	896000	50	4.37	1.33E+00	2.06E-01	8.46E-02	1.23E-01	2.58E-01	4.04E-01	6.09E-01	2.27E+00	3.41E+00	4.78E+00	5.90E+00	5.90E+00
20-39	2521000	139	4.09	1.09E+00	1.44E-01	7.93E-02	1.30E-01	1.67E-01	3.04E-01	6.15E-01	1.07E+00	2.00E+00	3.58E+00	1.29E+01	1.29E+01
40-69	4272000	247	7.53	1.25E+00	1.10E-01	6.46E-02	1.64E-01	2.54E-01	4.39E-01	7.19E-01	1.40E+00	2.61E+00	3.25E+00	1.30E+01	1.30E+01
70 +	2285000	118	14.39	1.39E+00	1.17E-01	4.41E-02	2.07E-01	2.82E-01	5.71E-01	9.57E-01	1.66E+00	3.73E+00	4.42E+00	5.39E+00	7.13E+00
<b>Season</b>															
Fall	2877000	100	6.04	1.37E+00	1.16E-01	2.59E-01	2.91E-01	3.42E-01	5.43E-01	1.03E+00	1.88E+00	2.88E+00	4.25E+00	5.41E+00	5.41E+00
Spring	2466000	265	5.34	1.49E+00	1.51E-01	8.91E-02	1.98E-01	2.54E-01	4.32E-01	8.56E-01	1.65E+00	2.91E+00	4.67E+00	8.27E+00	3.25E+01
Summer	3588000	122	7.89	1.75E+00	2.50E-01	0.00E+00	8.66E-02	1.30E-01	3.89E-01	6.41E-01	1.76E+00	4.29E+00	6.12E+00	1.30E+01	1.57E+01
Winter	2839000	192	5.83	1.27E+00	1.06E-01	4.15E-02	1.04E-01	2.31E-01	4.59E-01	8.29E-01	1.55E+00	2.61E+00	4.66E+00	8.16E+00	1.13E+01
<b>Urbanization</b>															
Central City	2552000	99	4.53	1.34E+00	1.98E-01	4.41E-02	1.01E-01	2.59E-01	4.46E-01	8.63E-01	1.60E+00	2.37E+00	2.88E+00	1.30E+01	1.30E+01
Nonmetropolitan	3891000	269	8.64	1.78E+00	1.67E-01	6.46E-02	1.04E-01	1.67E-01	4.15E-01	9.42E-01	1.94E+00	4.07E+00	5.98E+00	1.57E+01	3.25E+01
Suburban	5267000	309	6.08	1.36E+00	9.00E-02	9.18E-02	2.07E-01	2.93E-01	4.69E-01	7.73E-01	1.65E+00	3.16E+00	4.67E+00	7.29E+00	1.29E+01
<b>Race</b>															
Black	250000	12	1.15	*	*	*	*	*	*	*	*	*	*	*	*
White	11411000	663	7.24	1.51E+00	8.33E-02	6.49E-02	1.55E-01	2.59E-01	4.49E-01	8.56E-01	1.72E+00	3.31E+00	4.78E+00	1.20E+01	3.25E+01
<b>Region</b>															
Midwest	4429000	293	9.55	1.60E+00	1.42E-01	4.41E-02	1.25E-01	2.23E-01	4.23E-01	8.78E-01	1.88E+00	3.58E+00	4.78E+00	1.20E+01	3.25E+01
Northeast	1219000	69	2.96	7.55E-01	1.18E-01	8.08E-02	8.66E-02	1.65E-01	3.00E-01	4.74E-01	7.84E-01	1.39E+00	2.86E+00	5.21E+00	7.13E+00
South	2532000	141	3.94	1.51E+00	1.84E-01	7.93E-02	2.32E-01	3.01E-01	5.08E-01	9.16E-01	1.63E+00	2.63E+00	5.98E+00	1.57E+01	1.57E+01
West	3530000	174	9.79	1.60E+00	1.43E-01	1.00E-01	2.40E-01	3.17E-01	5.69E-01	9.57E-01	1.97E+00	3.72E+00	5.00E+00	1.30E+01	1.30E+01
<b>Response to Questionnaire</b>															
Households who garden	10197000	596	14.96	1.55E+00	9.12E-02	4.15E-02	1.58E-01	2.58E-01	4.49E-01	8.78E-01	1.73E+00	3.41E+00	5.00E+00	1.29E+01	3.25E+01
Households who farm	1917000	112	26.16	2.32E+00	2.50E-01	7.21E-02	2.76E-01	3.71E-01	6.81E-01	1.30E+00	3.14E+00	5.00E+00	6.12E+00	1.57E+01	1.57E+01

\* Intake data not provided for subpopulations for which there were less than 20 observations

NOTE: SE = standard error  
P = percentile of the distribution  
Nc wgtd = weighted number of consumers; Nc unwgtd = unweighted number of consumers in survey.

Source: Based on EPA's analyses of the 1987-88 NFCS



Table 13-62. Consumer Only Intake of Homegrown Protected Fruits (g/kg-day)

Population Group	Nc wgtd	Nc unwtgd	% Consuming	Mean	SE	P1	P5	P10	P25	P50	P75	P90	P95	P99	P100
Total	3855000	173	2.05	5.74E+00	6.25E-01	1.50E-01	2.66E-01	3.35E-01	9.33E-01	2.34E+00	7.45E+00	1.60E+01	1.97E+01	4.73E+01	5.36E+01
Age															
01-02	79000	5	1.39	*	*	*	*	*	*	*	*	*	*	*	*
03-05	80000	4	0.99	*	*	*	*	*	*	*	*	*	*	*	*
06-11	181000	9	1.08	*	*	*	*	*	*	*	*	*	*	*	*
12-19	377000	20	1.84	2.96E+00	9.93E-01	1.17E-01	1.60E-01	2.83E-01	3.93E-01	1.23E+00	2.84E+00	7.44E+00	1.14E+01	1.91E+01	1.91E+01
20-39	755000	29	1.23	4.51E+00	1.08E+00	1.81E-01	3.62E-01	4.87E-01	1.22E+00	1.88E+00	4.47E+00	1.46E+01	1.61E+01	2.41E+01	2.41E+01
40-69	1702000	77	3.00	5.65E+00	8.66E-01	1.12E-01	2.44E-01	2.87E-01	6.69E-01	2.22E+00	9.36E+00	1.55E+01	2.12E+01	4.13E+01	4.13E+01
70 +	601000	26	3.78	4.44E+00	6.91E-01	2.62E-01	2.62E-01	2.85E-01	1.95E+00	3.29E+00	7.06E+00	8.97E+00	9.97E+00	1.52E+01	1.52E+01
Season															
Fall	394000	12	0.83	*	*	*	*	*	*	*	*	*	*	*	*
Spring	497000	36	1.08	2.08E+00	3.47E-01	1.60E-01	1.81E-01	2.55E-01	3.78E-01	1.22E+00	4.08E+00	5.10E+00	6.57E+00	6.79E+00	6.79E+00
Summer	1425000	47	3.13	7.39E+00	1.45E+00	1.12E-01	2.66E-01	3.93E-01	1.25E+00	3.06E+00	1.03E+01	1.66E+01	2.41E+01	5.36E+01	5.36E+01
Winter	1539000	78	3.16	6.24E+00	9.10E-01	1.50E-01	3.02E-01	3.76E-01	1.39E+00	2.65E+00	8.23E+00	1.78E+01	2.12E+01	4.73E+01	4.73E+01
Urbanization															
Central City	1312000	50	2.33	3.94E+00	5.80E-01	1.50E-01	2.62E-01	3.33E-01	8.34E-01	3.01E+00	5.01E+00	9.23E+00	9.97E+00	1.88E+01	1.88E+01
Nonmetropolitan	506000	19	1.12	*	*	*	*	*	*	*	*	*	*	*	*
Suburban	2037000	104	2.35	6.83E+00	9.38E-01	1.12E-01	2.53E-01	2.92E-01	5.94E-01	2.01E+00	1.03E+01	1.79E+01	2.38E+01	5.36E+01	5.36E+01
Race															
Black	200000	8	0.92	*	*	*	*	*	*	*	*	*	*	*	*
White	3655000	165	2.32	5.91E+00	6.48E-01	1.17E-01	2.62E-01	3.33E-01	1.06E+00	2.44E+00	7.46E+00	1.60E+01	2.12E+01	4.73E+01	5.36E+01
Region															
Midwest	657000	24	1.42	1.07E+01	2.60E+00	2.53E-01	2.62E-01	2.85E-01	1.18E+00	7.44E+00	1.46E+01	2.41E+01	4.13E+01	5.36E+01	5.36E+01
Northeast	105000	5	0.26	*	*	*	*	*	*	*	*	*	*	*	*
South	1805000	74	2.81	4.77E+00	6.47E-01	1.60E-01	3.64E-01	4.50E-01	1.23E+00	2.54E+00	5.10E+00	1.52E+01	1.66E+01	2.38E+01	2.40E+01
West	1288000	70	3.57	4.85E+00	9.26E-01	1.12E-01	1.81E-01	2.68E-01	4.94E-01	1.84E+00	5.34E+00	1.23E+01	1.88E+01	4.73E+01	4.73E+01
Response to Questionnaire															
Households who garden	3360000	146	4.93	5.90E+00	6.97E-01	1.17E-01	2.65E-01	3.35E-01	1.16E+00	2.42E+00	7.46E+00	1.60E+01	1.91E+01	4.73E+01	5.36E+01
Households who farm	357000	14	4.87	*	*	*	*	*	*	*	*	*	*	*	*
* Intake data not provided for subpopulations for which there were less than 20 observations															
NOTE: SE = standard error P = percentile of the distribution Nc wgtd = weighted number of consumers; Nc unwtgd = unweighted number of consumers in survey.															
Source: Based on EPA's analyses of the 1987-88 NFCS															



Table 13-63. Consumer Only Intake of Homegrown Exposed Vegetables (g/kg-day)

Population Group	Nc wgted	Nc unwtgd	% Consuming	Mean	SE	P1	P5	P10	P25	P50	P75	P90	P95	P99	P100
Total	28762000	1511	15.30	1.52E+00	5.10E-02	3.25E-03	9.15E-02	1.72E-01	3.95E-01	8.60E-01	1.83E+00	3.55E+00	5.12E+00	1.03E+01	2.06E+01
<b>Age</b>															
01-02	815000	43	14.30	3.48E+00	5.14E-01	2.28E-02	2.39E-01	8.34E-01	1.20E+00	1.89E+00	4.23E+00	1.07E+01	1.19E+01	1.21E+01	1.21E+01
03-05	1069000	62	13.19	1.74E+00	2.20E-01	0.00E+00	7.23E-03	4.85E-02	5.79E-01	1.16E+00	2.53E+00	3.47E+00	6.29E+00	7.36E+00	8.86E+00
06-11	2454000	134	14.68	1.39E+00	1.76E-01	0.00E+00	4.44E-02	9.42E-02	3.12E-01	6.43E-01	1.60E+00	3.22E+00	5.47E+00	1.33E+01	1.33E+01
12-19	2611000	143	12.74	1.07E+00	9.43E-02	0.00E+00	2.92E-02	1.42E-01	3.04E-01	6.56E-01	1.46E+00	2.35E+00	3.78E+00	5.67E+00	5.67E+00
20-39	6969000	348	11.31	1.05E+00	8.14E-02	8.20E-03	6.56E-02	1.17E-01	2.55E-01	5.58E-01	1.26E+00	2.33E+00	3.32E+00	7.57E+00	2.06E+01
40-69	10993000	579	19.38	1.60E+00	8.32E-02	3.25E-03	1.41E-01	2.44E-01	4.79E-01	9.81E-01	1.92E+00	3.59E+00	5.22E+00	8.99E+00	1.90E+01
70 +	3517000	185	22.15	1.68E+00	1.21E-01	5.21E-03	1.51E-01	2.39E-01	5.22E-01	1.13E+00	2.38E+00	4.08E+00	4.96E+00	6.96E+00	1.02E+01
<b>Season</b>															
Fall	8865000	314	18.60	1.31E+00	9.80E-02	5.24E-02	1.11E-01	1.80E-01	3.33E-01	6.49E-01	1.56E+00	3.13E+00	4.45E+00	8.92E+00	1.22E+01
Spring	4863000	487	10.54	1.14E+00	6.35E-02	2.35E-03	4.53E-02	1.53E-01	3.38E-01	6.58E-01	1.39E+00	2.76E+00	4.02E+00	7.51E+00	1.07E+01
Summer	10151000	348	22.32	2.03E+00	1.26E-01	2.17E-03	1.13E-01	2.04E-01	6.07E-01	1.30E+00	2.52E+00	4.32E+00	6.35E+00	1.27E+01	1.90E+01
Winter	4883000	362	10.02	1.21E+00	9.50E-02	4.23E-03	2.28E-02	1.37E-01	3.70E-01	6.67E-01	1.42E+00	2.76E+00	3.69E+00	8.86E+00	2.06E+01
<b>Urbanization</b>															
Central City	4859000	173	8.62	1.11E+00	1.02E-01	1.01E-02	6.04E-02	8.02E-02	2.83E-01	7.01E-01	1.43E+00	2.49E+00	3.29E+00	8.34E+00	1.21E+01
Nonmetropolitan	11577000	711	25.71	1.87E+00	8.79E-02	1.65E-02	1.72E-01	2.52E-01	5.01E-01	1.16E+00	2.20E+00	4.12E+00	6.10E+00	1.22E+01	1.90E+01
Suburban	12266000	625	14.17	1.35E+00	7.01E-02	2.93E-03	9.68E-02	1.56E-01	3.55E-01	7.44E-01	1.58E+00	3.22E+00	5.22E+00	8.61E+00	2.06E+01
<b>Race</b>															
Black	1713000	100	7.88	1.23E+00	1.27E-01	0.00E+00	7.74E-02	1.41E-01	3.52E-01	8.93E-01	1.51E+00	3.32E+00	3.92E+00	5.55E+00	7.19E+00
White	26551000	1386	16.85	1.53E+00	5.41E-02	4.67E-03	9.74E-02	1.77E-01	3.95E-01	8.59E-01	1.82E+00	3.48E+00	5.12E+00	1.03E+01	2.06E+01
<b>Region</b>															
Midwest	10402000	570	22.42	1.48E+00	8.91E-02	1.00E-02	7.14E-02	1.57E-01	3.88E-01	8.06E-01	1.69E+00	3.55E+00	4.67E+00	1.19E+01	2.06E+01
Northeast	4050000	191	9.84	1.65E+00	1.78E-01	2.35E-03	8.05E-02	1.38E-01	2.61E-01	6.65E-01	1.75E+00	5.58E+00	6.80E+00	1.27E+01	1.49E+01
South	9238000	503	14.36	1.55E+00	7.79E-02	5.20E-02	1.63E-01	2.61E-01	5.18E-01	9.99E-01	1.92E+00	3.19E+00	4.52E+00	9.92E+00	1.33E+01
West	5012000	245	13.90	1.43E+00	1.02E-01	3.25E-03	2.61E-02	1.45E-01	3.91E-01	7.63E-01	2.13E+00	3.45E+00	4.84E+00	7.51E+00	8.34E+00
<b>Response to Questionnaire</b>															
Households who garden	25737000	1361	37.76	1.57	5.50E-02	3.25E-03	8.87E-02	1.68E-01	4.13E-01	8.89E-01	1.97E+00	3.63E+00	5.45E+00	1.03E+01	2.06E+01
Households who farm	3596000	207	49.07	2.17	1.61E-01	0.00E+00	1.84E-01	3.72E-01	6.47E-01	1.38E+00	2.81E+00	6.01E+00	6.83E+00	1.03E+01	1.33E+01
NOTE: SE = standard error P = percentile of the distribution Nc wgted = weighted number of consumers; Nc unwtgd = unweighted number of consumers in survey. Source: Based on EPA's analyses of the 1987-88 NFCS															



Table 13-64. Consumer Only Intake of Homegrown Protected Vegetables (g/kg-day)

Population Group	Nc wgted	Nc unwtgd	% Consuming	Mean	SE	P1	P5	P10	P25	P50	P75	P90	P95	P99	P100
Total	11428000	656	6.08	1.01E+00	4.95E-02	1.03E-01	1.54E-01	1.94E-01	3.22E-01	6.25E-01	1.20E+00	2.24E+00	3.05E+00	6.49E+00	9.42E+00
<b>Age</b>															
01-02	348000	21	6.11	2.46E+00	4.91E-01	3.15E-01	3.15E-01	5.38E-01	1.36E+00	1.94E+00	2.96E+00	3.88E+00	9.42E+00	9.42E+00	9.42E+00
03-05	440000	32	5.43	1.30E+00	2.13E-01	2.33E-01	2.33E-01	3.22E-01	4.80E-01	1.04E+00	1.48E+00	2.51E+00	5.10E+00	5.31E+00	5.31E+00
06-11	1052000	63	6.30	1.10E+00	1.34E-01	1.89E-01	2.08E-01	3.18E-01	3.87E-01	7.91E-01	1.31E+00	2.14E+00	3.12E+00	5.40E+00	5.40E+00
12-19	910000	51	4.44	7.76E-01	8.71E-02	5.88E-02	1.61E-01	2.39E-01	3.54E-01	5.83E-01	8.24E-01	1.85E+00	2.20E+00	2.69E+00	2.69E+00
20-39	3227000	164	5.24	7.62E-01	6.03E-02	1.13E-01	1.52E-01	1.71E-01	2.41E-01	5.08E-01	9.67E-01	1.73E+00	2.51E+00	3.63E+00	4.76E+00
40-69	3818000	226	6.73	9.30E-01	7.32E-02	6.87E-02	1.35E-01	1.66E-01	3.16E-01	6.03E-01	1.11E+00	1.87E+00	3.04E+00	6.84E+00	7.44E+00
70 +	1442000	89	9.08	1.05E+00	1.62E-01	1.19E-01	2.10E-01	2.42E-01	3.57E-01	5.72E-01	1.21E+00	1.86E+00	3.05E+00	9.23E+00	9.23E+00
<b>Season</b>															
Fall	3907000	143	8.20	8.51E-01	7.02E-02	1.19E-01	1.61E-01	2.04E-01	3.22E-01	5.68E-01	1.10E+00	1.73E+00	2.51E+00	4.78E+00	5.31E+00
Spring	2086000	236	4.52	7.02E-01	4.48E-02	5.88E-02	1.35E-01	1.70E-01	2.66E-01	4.90E-01	9.08E-01	1.44E+00	1.86E+00	3.74E+00	5.73E+00
Summer	3559000	118	7.82	1.40E+00	1.56E-01	1.03E-01	1.77E-01	2.33E-01	3.81E-01	7.81E-01	1.69E+00	3.05E+00	5.40E+00	9.23E+00	9.42E+00
Winter	1876000	159	3.85	9.30E-01	7.70E-02	1.18E-01	1.42E-01	1.82E-01	3.12E-01	6.01E-01	1.20E+00	2.32E+00	3.06E+00	4.76E+00	6.39E+00
<b>Urbanization</b>															
Central City	1342000	49	2.38	9.96E-01	1.51E-01	1.19E-01	1.53E-01	1.67E-01	3.18E-01	7.21E-01	1.18E+00	2.36E+00	2.83E+00	4.78E+00	4.78E+00
Nonmetropolitan	5934000	391	13.18	1.07E+00	6.36E-02	1.14E-01	1.66E-01	2.14E-01	3.53E-01	6.48E-01	1.30E+00	2.51E+00	3.55E+00	6.84E+00	9.42E+00
Suburban	4152000	216	4.80	9.26E-01	7.97E-02	6.87E-02	1.50E-01	1.88E-01	2.94E-01	5.64E-01	1.15E+00	1.85E+00	2.67E+00	6.49E+00	9.23E+00
<b>Race</b>															
Black	479000	27	2.20	1.50E+00	2.25E-01	1.62E-01	2.64E-01	3.31E-01	8.66E-01	9.35E-01	2.20E+00	3.05E+00	3.23E+00	4.95E+00	4.95E+00
White	10836000	625	6.88	9.93E-01	4.83E-02	1.03E-01	1.53E-01	1.92E-01	3.21E-01	6.10E-01	1.20E+00	2.17E+00	3.04E+00	6.49E+00	9.42E+00
<b>Region</b>															
Midwest	4359000	273	9.40	1.01E+00	7.38E-02	1.13E-01	1.71E-01	2.31E-01	3.26E-01	5.72E-01	1.08E+00	2.45E+00	3.68E+00	6.84E+00	7.44E+00
Northeast	807000	48	1.96	7.01E-01	8.99E-02	5.88E-02	1.50E-01	1.68E-01	2.65E-01	5.09E-01	9.91E-01	1.71E+00	2.33E+00	2.77E+00	2.77E+00
South	4449000	253	6.92	1.08E+00	7.17E-02	1.29E-01	1.71E-01	2.14E-01	3.76E-01	7.12E-01	1.38E+00	2.32E+00	3.05E+00	5.40E+00	9.42E+00
West	1813000	82	5.03	9.57E-01	1.62E-01	6.87E-02	1.19E-01	1.52E-01	2.08E-01	4.79E-01	1.01E+00	1.86E+00	3.12E+00	9.23E+00	9.23E+00
<b>Response to Questionnaire</b>															
Households who garden	10286000	602	15.09	1.01E+00	4.73E-02	1.03E-01	1.53E-01	1.92E-01	3.36E-01	6.42E-01	1.21E+00	2.32E+00	3.05E+00	6.49E+00	9.23E+00
Households who farm	2325000	142	31.72	1.30E+00	1.45E-01	8.65E-02	1.66E-01	2.09E-01	3.37E-01	5.99E-01	1.40E+00	3.55E+00	5.40E+00	9.23E+00	9.23E+00
NOTE: SE = standard error P = percentile of the distribution Nc wgted = weighted number of consumers; Nc unwtgd = unweighted number of consumers in survey. Source: Based on EPA's analyses of the 1987-88 NFCS															



Table 13-65. Consumer Only Intake of Homegrown Root Vegetables (g/kg-day)

Population Group	Nc wgt'd	Nc unwt'd	% Consuming	Mean	SE	P1	P5	P10	P25	P50	P75	P90	P95	P99	P100
Total	13750000	743	7.31	1.16E+00	5.84E-02	4.72E-03	3.64E-02	1.12E-01	2.51E-01	6.66E-01	1.47E+00	2.81E+00	3.71E+00	9.52E+00	1.28E+01
<b>Age</b>															
01-02	371000	22	6.51	2.52E+00	6.10E-01	1.66E-01	1.66E-01	2.19E-01	3.59E-01	9.20E-01	3.67E+00	7.25E+00	1.04E+01	1.04E+01	1.04E+01
03-05	390000	23	4.81	1.28E+00	3.24E-01	0.00E+00	0.00E+00	1.17E-01	2.25E-01	4.62E-01	1.68E+00	4.26E+00	4.73E+00	4.73E+00	4.73E+00
06-11	1106000	67	6.62	1.32E+00	2.14E-01	0.00E+00	1.39E-02	3.64E-02	2.32E-01	5.23E-01	1.63E+00	3.83E+00	5.59E+00	7.47E+00	7.47E+00
12-19	1465000	76	7.15	9.37E-01	1.19E-01	7.59E-03	8.00E-03	6.84E-02	2.69E-01	5.65E-01	1.37E+00	2.26E+00	3.32E+00	5.13E+00	5.13E+00
20-39	3252000	164	5.28	8.74E-01	7.39E-02	1.21E-02	5.35E-02	9.93E-02	2.00E-01	5.64E-01	1.24E+00	2.11E+00	3.08E+00	4.64E+00	6.03E+00
40-69	4903000	276	8.64	1.13E+00	9.86E-02	3.34E-03	3.29E-02	1.17E-01	2.51E-01	6.75E-01	1.27E+00	2.74E+00	3.56E+00	9.52E+00	1.28E+01
70 +	2096000	107	13.20	1.22E+00	1.02E-01	1.73E-02	2.90E-02	1.69E-01	3.76E-01	8.51E-01	1.71E+00	2.86E+00	3.21E+00	4.01E+00	4.77E+00
<b>Season</b>															
Fall	4026000	153	8.45	1.42E+00	1.53E-01	5.15E-02	1.38E-01	1.72E-01	3.09E-01	9.20E-01	1.67E+00	3.26E+00	3.85E+00	1.23E+01	1.28E+01
Spring	2552000	260	5.53	6.87E-01	6.08E-02	3.34E-03	1.73E-02	3.00E-02	1.44E-01	3.65E-01	7.69E-01	1.69E+00	2.80E+00	4.24E+00	7.69E+00
Summer	5011000	169	11.02	1.19E+00	1.20E-01	0.00E+00	4.76E-02	1.32E-01	2.77E-01	7.26E-01	1.51E+00	2.74E+00	3.64E+00	1.04E+01	1.19E+01
Winter	2161000	161	4.44	1.17E+00	1.19E-01	3.23E-03	8.57E-03	4.34E-02	2.38E-01	5.57E-01	1.56E+00	3.08E+00	4.14E+00	6.21E+00	1.13E+01
<b>Urbanization</b>															
Central City	2385000	96	4.23	7.49E-01	8.40E-02	2.68E-02	3.90E-02	1.43E-01	2.23E-01	4.26E-01	9.16E-01	1.91E+00	2.70E+00	3.56E+00	3.93E+00
Nonmetropolitan	6094000	366	13.54	1.43E+00	9.81E-02	8.57E-03	6.87E-02	1.29E-01	2.78E-01	7.58E-01	1.85E+00	3.32E+00	4.24E+00	1.13E+01	1.28E+01
Suburban	5211000	279	6.02	1.06E+00	8.62E-02	3.73E-03	1.21E-02	7.17E-02	2.32E-01	7.34E-01	1.19E+00	2.34E+00	3.26E+00	6.29E+00	1.19E+01
<b>Race</b>															
Black	521000	31	2.40	8.83E-01	3.93E-01	4.72E-03	9.28E-03	3.64E-02	8.82E-02	5.42E-01	7.65E-01	1.06E+00	1.25E+00	1.23E+01	1.23E+01
White	12861000	697	8.16	1.18E+00	5.97E-02	7.79E-03	4.58E-02	1.29E-01	2.61E-01	6.80E-01	1.50E+00	2.82E+00	3.72E+00	9.52E+00	1.28E+01
<b>Region</b>															
Midwest	5572000	314	12.01	1.31E+00	9.54E-02	3.37E-02	7.48E-02	1.66E-01	2.69E-01	7.39E-01	1.67E+00	3.23E+00	4.26E+00	1.04E+01	1.19E+01
Northeast	1721000	92	4.18	8.38E-01	1.03E-01	3.23E-03	7.79E-03	8.69E-03	1.43E-01	4.81E-01	1.18E+00	2.05E+00	2.77E+00	4.78E+00	6.03E+00
South	3842000	205	5.97	1.38E+00	1.38E-01	1.10E-02	5.35E-02	1.32E-01	2.77E-01	6.90E-01	1.70E+00	3.32E+00	3.83E+00	1.23E+01	1.28E+01
West	2555000	130	7.08	7.68E-01	6.43E-02	4.72E-03	2.24E-02	1.14E-01	2.38E-01	5.70E-01	9.77E-01	1.69E+00	2.45E+00	3.72E+00	3.72E+00
<b>Response to Questionnaire</b>															
Households who garden	12578000	682	18.46	1.15E+00	5.72E-02	4.79E-03	3.64E-02	1.17E-01	2.58E-01	6.74E-01	1.50E+00	2.81E+00	3.64E+00	7.47E+00	1.28E+01
Households who farm	2367000	136	32.30	1.39E+00	1.26E-01	1.11E-01	1.58E-01	1.84E-01	3.65E-01	8.83E-01	1.85E+00	3.11E+00	4.58E+00	7.47E+00	7.69E+00

NOTE: SE = standard error  
P = percentile of the distribution  
Nc wgt'd = weighted number of consumers; Nc unwt'd = unweighted number of consumers in survey.  
Source: Based on EPA's analyses of the 1987-88 NFCS



Table 13-66. Consumer Only Intake of Homegrown Dark Green Vegetables (g/kg-day)

Population Group	Nc wgted	Nc unwtgd	% Consuming	Mean	SE	P1	P5	P10	P25	P50	P75	P90	P95	P99	P100
Total	8855000	428	4.71	3.91E-01	2.95E-02	2.01E-03	4.28E-03	1.01E-02	8.70E-02	2.11E-01	4.35E-01	9.19E-01	1.25E+00	3.53E+00	5.82E+00
<b>Age</b>															
01-02	180000	8	3.16	*	*	*	*	*	*	*	*	*	*	*	*
03-05	226000	12	2.79	*	*	*	*	*	*	*	*	*	*	*	*
06-11	826000	39	4.94	3.05E-01	5.19E-02	0.00E+00	6.34E-03	2.42E-02	9.00E-02	1.81E-01	3.87E-01	9.48E-01	1.04E+00	1.28E+00	1.28E+00
12-19	628000	32	3.07	4.20E-01	1.47E-01	4.92E-03	5.38E-03	6.65E-03	5.62E-02	2.03E-01	3.73E-01	9.24E-01	1.64E+00	4.86E+00	4.86E+00
20-39	1976000	87	3.21	3.36E-01	6.09E-02	2.21E-03	3.74E-03	1.00E-02	8.70E-02	1.76E-01	3.79E-01	6.69E-01	9.19E-01	2.94E+00	4.29E+00
40-69	3710000	184	6.54	4.01E-01	4.24E-02	2.25E-03	3.67E-03	2.60E-02	8.19E-02	2.33E-01	4.80E-01	9.79E-01	1.25E+00	3.29E+00	5.82E+00
70 +	1253000	63	7.89	4.08E-01	7.27E-02	2.84E-03	4.23E-03	5.68E-03	1.10E-01	2.31E-01	4.69E-01	9.29E-01	1.08E+00	3.45E+00	3.45E+00
<b>Season</b>															
Fall	2683000	88	5.63	4.41E-01	7.42E-02	1.01E-02	4.46E-02	8.70E-02	1.45E-01	2.38E-01	4.59E-01	7.90E-01	1.08E+00	3.86E+00	4.29E+00
Spring	1251000	127	2.71	5.59E-01	7.90E-02	1.63E-03	3.66E-03	5.72E-03	1.01E-01	3.09E-01	5.38E-01	1.28E+00	2.81E+00	4.86E+00	5.82E+00
Summer	3580000	124	7.87	3.39E-01	4.10E-02	0.00E+00	2.84E-03	5.68E-03	6.34E-02	1.51E-01	4.05E-01	9.79E-01	1.15E+00	2.48E+00	2.48E+00
Winter	1341000	89	2.75	2.72E-01	3.92E-02	2.01E-03	3.97E-03	5.21E-03	2.30E-02	1.51E-01	3.71E-01	6.59E-01	1.17E+00	2.04E+00	2.18E+00
<b>Urbanization</b>															
Central City	1298000	48	2.30	2.69E-01	3.68E-02	2.84E-03	4.71E-03	1.01E-02	1.06E-01	2.05E-01	3.24E-01	6.32E-01	9.19E-01	1.07E+00	1.07E+00
Nonmetropolitan	3218000	167	7.15	3.31E-01	3.54E-02	2.21E-03	4.67E-03	1.70E-02	6.86E-02	1.72E-01	4.52E-01	7.52E-01	1.00E+00	2.48E+00	5.82E+00
Suburban	4279000	211	4.94	4.79E-01	5.23E-02	2.25E-03	5.21E-03	2.15E-02	9.22E-02	2.33E-01	4.59E-01	1.15E+00	2.18E+00	3.86E+00	4.86E+00
<b>Race</b>															
Black	724000	49	3.33	1.04E+00	1.80E-01	0.00E+00	1.00E-01	1.13E-01	2.21E-01	5.52E-01	1.17E+00	3.29E+00	3.86E+00	4.86E+00	4.86E+00
White	7963000	373	5.05	3.21E-01	2.20E-02	2.25E-03	4.67E-03	1.01E-02	7.75E-02	1.99E-01	3.79E-01	7.76E-01	1.07E+00	2.37E+00	5.82E+00
<b>Region</b>															
Midwest	2668000	121	5.75	2.81E-01	3.54E-02	2.84E-03	4.77E-03	6.26E-03	6.34E-02	2.11E-01	3.58E-01	4.96E-01	9.79E-01	2.48E+00	3.02E+00
Northeast	1554000	76	3.77	5.08E-01	9.14E-02	2.17E-03	2.80E-03	4.23E-03	5.62E-02	1.96E-01	4.92E-01	1.25E+00	1.93E+00	3.53E+00	5.82E+00
South	2945000	148	4.58	4.78E-01	5.07E-02	3.64E-02	6.83E-02	9.23E-02	1.45E-01	2.87E-01	6.43E-01	9.24E-01	1.28E+00	3.86E+00	4.29E+00
West	1628000	81	4.51	3.18E-01	7.25E-02	2.25E-03	3.37E-03	6.34E-03	3.50E-02	1.10E-01	3.09E-01	6.59E-01	9.29E-01	4.86E+00	4.86E+00
<b>Response to Questionnaire</b>															
Households who garden	8521000	412	12.50	3.95E-01	3.03E-02	1.63E-03	4.23E-03	1.05E-02	8.76E-02	2.12E-01	4.48E-01	9.19E-01	1.25E+00	3.53E+00	5.82E+00
Households who farm	1450000	66	19.78	3.80E-01	6.08E-02	1.62E-03	4.67E-03	5.38E-03	6.68E-02	2.31E-01	4.84E-01	9.48E-01	1.25E+00	2.48E+00	3.02E+00
* Intake data not provided for subpopulations for which there were less than 20 observations															
NOTE: SE = standard error P = percentile of the distribution Nc wgted = weighted number of consumers; Nc unwtgd = unweighted number of consumers in survey.															
Source: Based on EPA's analyses of the 1987-88 NFCS															



Table 13-67. Consumer Only Intake of Homegrown Deep Yellow Vegetables (g/kg-day)

Population Group	Nc wgtd	Nc unwtgd	% Consuming	Mean	SE	P1	P5	P10	P25	P50	P75	P90	P95	P99	P100
Total	5467000	245	2.91	6.43E-01	4.44E-02	4.34E-02	6.70E-02	1.26E-01	2.22E-01	4.17E-01	7.74E-01	1.44E+00	2.03E+00	2.67E+00	6.63E+00
<b>Age</b>															
01-02	124000	8	2.18	*	*	*	*	*	*	*	*	*	*	*	*
03-05	61000	4	0.75	*	*	*	*	*	*	*	*	*	*	*	*
06-11	382000	17	2.29	*	*	*	*	*	*	*	*	*	*	*	*
12-19	493000	21	2.41	4.73E-01	9.18E-02	6.05E-02	6.05E-02	6.29E-02	9.07E-02	3.63E-01	7.79E-01	1.13E+00	1.44E+00	1.58E+00	1.58E+00
20-39	1475000	63	2.39	5.32E-01	7.54E-02	4.89E-02	5.55E-02	1.15E-01	1.66E-01	3.05E-01	5.11E-01	1.22E+00	2.03E+00	2.67E+00	2.67E+00
40-69	2074000	96	3.66	5.39E-01	5.15E-02	3.90E-02	9.22E-02	1.43E-01	2.21E-01	4.03E-01	6.54E-01	1.09E+00	1.33E+00	3.02E+00	3.02E+00
70 +	761000	32	4.79	7.81E-01	9.20E-02	7.64E-02	2.02E-01	2.77E-01	3.70E-01	5.72E-01	1.24E+00	1.61E+00	1.99E+00	1.99E+00	1.99E+00
<b>Season</b>															
Fall	2664000	97	5.59	7.38E-01	8.18E-02	9.21E-02	1.22E-01	1.43E-01	2.61E-01	4.51E-01	9.74E-01	1.73E+00	2.23E+00	3.02E+00	6.63E+00
Spring	315000	34	0.68	5.64E-01	7.52E-02	1.43E-01	1.45E-01	1.98E-01	2.47E-01	4.45E-01	6.43E-01	1.01E+00	1.42E+00	2.41E+00	2.41E+00
Summer	1619000	52	3.56	5.09E-01	6.37E-02	4.16E-02	5.49E-02	6.48E-02	2.26E-01	4.10E-01	6.35E-01	9.64E-01	1.67E+00	2.31E+00	2.31E+00
Winter	869000	62	1.78	6.29E-01	9.15E-02	3.90E-02	4.34E-02	6.29E-02	1.72E-01	3.52E-01	7.96E-01	1.54E+00	2.23E+00	4.37E+00	4.37E+00
<b>Urbanization</b>															
Central City	1308000	43	2.32	5.07E-01	7.07E-02	3.90E-02	6.29E-02	1.43E-01	2.13E-01	3.88E-01	5.88E-01	9.64E-01	1.41E+00	2.24E+00	2.24E+00
Nonmetropolitan	2100000	118	4.66	6.66E-01	7.72E-02	4.16E-02	5.55E-02	9.07E-02	2.20E-01	3.70E-01	8.65E-01	1.39E+00	2.12E+00	4.37E+00	6.63E+00
Suburban	2059000	84	2.38	7.07E-01	6.99E-02	6.48E-02	9.22E-02	1.26E-01	2.62E-01	4.25E-01	9.74E-01	1.67E+00	2.03E+00	2.67E+00	2.67E+00
<b>Race</b>															
Black	129000	8	0.59	*	*	*	*	*	*	*	*	*	*	*	*
White	5093000	229	3.23	6.45E-01	4.03E-02	4.89E-02	9.21E-02	1.43E-01	2.41E-01	4.25E-01	7.96E-01	1.50E+00	2.03E+00	2.67E+00	4.37E+00
<b>Region</b>															
Midwest	2792000	128	6.02	7.52E-01	6.01E-02	4.34E-02	1.32E-01	1.93E-01	2.82E-01	5.09E-01	9.55E-01	1.73E+00	2.23E+00	3.02E+00	4.37E+00
Northeast	735000	29	1.79	3.96E-01	8.06E-02	4.16E-02	5.55E-02	6.05E-02	9.22E-02	1.50E-01	6.35E-01	1.09E+00	1.37E+00	2.21E+00	2.21E+00
South	557000	30	0.87	5.39E-01	2.08E-01	4.89E-02	5.49E-02	7.74E-02	2.20E-01	3.05E-01	4.38E-01	7.74E-01	1.22E+00	6.63E+00	6.63E+00
West	1383000	58	3.83	5.97E-01	7.07E-02	6.48E-02	1.27E-01	1.43E-01	2.21E-01	4.10E-01	6.42E-01	1.44E+00	1.89E+00	2.31E+00	2.31E+00
<b>Response to Questionnaire</b>															
Households who garden	5177000	233	7.60	6.23E-01	3.93E-02	4.16E-02	9.07E-02	1.32E-01	2.32E-01	4.15E-01	7.50E-01	1.42E+00	1.99E+00	2.67E+00	4.37E+00
Households who farm	1088000	51	14.85	6.06E-01	8.52E-02	9.21E-02	9.22E-02	1.22E-01	1.94E-01	3.40E-01	9.40E-01	1.28E+00	1.73E+00	3.02E+00	3.02E+00

\* Intake data not provided for subpopulations for which there were less than 20 observations

NOTE: SE = standard error

P = percentile of the distribution

Nc wgtd = weighted number of consumers; Nc unwtgd = unweighted number of consumers in survey.

Source: Based on EPA's analyses of the 1987-88 NFCS





Table13-68. Consumer Only Intake of Homegrown Other Vegetables (g/kg-day)

Population Group	Nc wgtd	Nc unwtgd	% Consuming	Mean	SE	P1	P5	P10	P25	P50	P75	P90	P95	P99	P100
Total	25221000	1437	13.41	1.38E+00	5.00E-02	9.44E-03	1.07E-01	1.76E-01	3.62E-01	7.78E-01	1.65E+00	3.09E+00	4.52E+00	9.95E+00	1.84E+01
<b>Age</b>															
01-02	613000	38	10.76	3.80E+00	6.27E-01	1.92E-01	2.73E-01	4.04E-01	1.04E+00	2.61E+00	4.55E+00	7.74E+00	1.12E+01	1.80E+01	1.80E+01
03-05	887000	59	10.95	2.15E+00	2.67E-01	0.00E+00	2.28E-01	3.72E-01	7.20E-01	1.37E+00	3.16E+00	4.47E+00	5.96E+00	8.41E+00	1.40E+01
06-11	2149000	134	12.86	1.30E+00	1.38E-01	0.00E+00	1.21E-01	1.93E-01	3.54E-01	8.00E-01	1.61E+00	3.04E+00	4.57E+00	9.95E+00	9.95E+00
12-19	2379000	141	11.61	9.80E-01	8.56E-02	0.00E+00	5.76E-02	1.15E-01	3.17E-01	6.40E-01	1.33E+00	2.05E+00	3.17E+00	5.41E+00	5.41E+00
20-39	6020000	328	9.77	9.30E-01	6.00E-02	3.19E-02	9.37E-02	1.48E-01	2.43E-01	5.60E-01	1.12E+00	2.19E+00	3.04E+00	5.10E+00	7.00E+00
40-69	9649000	547	17.01	1.40E+00	8.72E-02	5.20E-03	1.11E-01	1.86E-01	3.95E-01	8.43E-01	1.58E+00	2.92E+00	4.65E+00	1.41E+01	1.84E+01
70 +	3226000	174	20.31	1.58E+00	1.41E-01	1.85E-02	1.52E-01	2.38E-01	4.62E-01	9.48E-01	1.91E+00	3.46E+00	5.79E+00	9.96E+00	1.14E+01
<b>Season</b>															
Fall	6934000	253	14.55	1.19E+00	8.62E-02	4.92E-02	1.48E-01	1.86E-01	3.28E-01	7.16E-01	1.44E+00	2.74E+00	4.00E+00	6.74E+00	9.96E+00
Spring	5407000	567	11.71	1.16E+00	6.19E-02	3.66E-03	4.32E-02	1.04E-01	3.10E-01	7.10E-01	1.39E+00	2.67E+00	4.21E+00	7.35E+00	1.40E+01
Summer	8454000	283	18.59	1.79E+00	1.53E-01	0.00E+00	1.18E-01	1.81E-01	3.85E-01	9.68E-01	1.97E+00	4.13E+00	6.14E+00	1.46E+01	1.84E+01
Winter	4426000	334	9.09	1.19E+00	7.28E-02	4.79E-03	1.41E-01	2.31E-01	4.09E-01	7.33E-01	1.49E+00	2.41E+00	3.37E+00	7.00E+00	1.10E+01
<b>Urbanization</b>															
Central City	4148000	161	7.36	9.66E-01	8.81E-02	3.50E-02	9.37E-02	1.63E-01	3.24E-01	6.07E-01	1.23E+00	1.97E+00	3.22E+00	7.00E+00	8.85E+00
Nonmetropolitan	10721000	710	23.81	1.78E+00	8.99E-02	2.74E-02	1.60E-01	2.26E-01	4.68E-01	1.01E+00	2.01E+00	4.05E+00	5.74E+00	1.41E+01	1.84E+01
Suburban	10292000	564	11.89	1.14E+00	5.98E-02	4.79E-03	8.98E-02	1.46E-01	3.06E-01	6.47E-01	1.44E+00	2.69E+00	3.77E+00	6.81E+00	1.14E+01
<b>Race</b>															
Black	1347000	84	6.19	1.30E+00	1.70E-01	4.41E-02	1.74E-01	2.06E-01	3.50E-01	7.11E-01	1.49E+00	3.88E+00	5.47E+00	6.21E+00	7.72E+00
White	23367000	1327	14.83	1.39E+00	5.26E-02	1.29E-02	1.10E-01	1.79E-01	3.76E-01	7.93E-01	1.65E+00	3.04E+00	4.49E+00	9.96E+00	1.84E+01
<b>Region</b>															
Midwest	8296000	522	17.88	1.43E+00	9.25E-02	3.19E-02	1.21E-01	1.90E-01	3.66E-01	7.29E-01	1.65E+00	3.05E+00	4.65E+00	1.12E+01	1.84E+01
Northeast	2914000	162	7.08	1.33E+00	1.65E-01	1.97E-03	5.69E-02	1.07E-01	2.44E-01	5.97E-01	1.64E+00	3.07E+00	5.41E+00	1.20E+01	1.41E+01
South	9218000	518	14.33	1.53E+00	7.82E-02	1.41E-02	1.68E-01	2.53E-01	4.87E-01	1.03E+00	1.76E+00	3.37E+00	4.70E+00	8.33E+00	1.80E+01
West	4733000	233	13.12	1.08E+00	9.85E-02	1.11E-02	7.06E-02	1.22E-01	2.55E-01	5.73E-01	1.21E+00	2.41E+00	3.73E+00	8.02E+00	1.14E+01
<b>Response to Questionnaire</b>															
Households who garden	22417000	1291	32.89	1.44E+00	5.25E-02	1.11E-02	1.11E-01	1.80E-01	3.84E-01	8.18E-01	1.70E+00	3.22E+00	4.65E+00	9.95E+00	1.84E+01
Households who farm	3965000	239	54.10	1.95E+00	1.63E-01	1.41E-02	1.36E-01	2.34E-01	5.20E-01	1.21E+00	2.04E+00	5.32E+00	7.02E+00	1.46E+01	1.59E+01
NOTE: SE = standard error P = percentile of the distribution Nc wgtd = weighted number of consumers; Nc unwtgd = unweighted number of consumers in survey. Source: Based on EPA's analyses of the 1987-88 NFCS															



Table 13-69. Consumer Only Intake of Homegrown Citrus (g/kg-day)

Population Group	Nc wgted	Nc unwtgd	% Consuming	Mean	SE	P1	P5	P10	P25	P50	P75	P90	P95	P99	P100
Total	2530000	125	1.35	4.76E+00	6.05E-01	7.82E-02	1.57E-01	2.86E-01	7.56E-01	1.99E+00	5.10E+00	1.41E+01	1.97E+01	3.22E+01	4.79E+01
Age															
01-02	54000	4	0.95	*	*	*	*	*	*	*	*	*	*	*	*
03-05	51000	3	0.63	*	*	*	*	*	*	*	*	*	*	*	*
06-11	181000	9	1.08	*	*	*	*	*	*	*	*	*	*	*	*
12-19	194000	14	0.95	*	*	*	*	*	*	*	*	*	*	*	*
20-39	402000	18	0.65	*	*	*	*	*	*	*	*	*	*	*	*
40-69	1183000	55	2.09	4.54E+00	8.06E-01	8.11E-02	1.50E-01	2.47E-01	5.21E-01	1.74E+00	5.24E+00	1.52E+01	1.97E+01	2.38E+01	2.38E+01
70 +	457000	21	2.88	4.43E+00	7.58E-01	7.82E-02	7.82E-02	4.94E-01	1.95E+00	3.53E+00	6.94E+00	8.97E+00	8.97E+00	1.57E+01	1.57E+01
Season															
Fall	280000	8	0.59	*	*	*	*	*	*	*	*	*	*	*	*
Spring	437000	33	0.95	2.31E+00	3.76E-01	1.57E-01	1.84E-01	2.35E-01	3.69E-01	1.36E+00	4.15E+00	5.10E+00	6.50E+00	7.52E+00	7.52E+00
Summer	334000	11	0.73	*	*	*	*	*	*	*	*	*	*	*	*
Winter	1479000	73	3.04	6.47E+00	9.53E-01	1.50E-01	3.33E-01	4.94E-01	1.64E+00	2.93E+00	8.59E+00	1.91E+01	2.38E+01	4.79E+01	4.79E+01
Urbanization															
Central City	1053000	43	1.87	3.57E+00	5.18E-01	1.50E-01	3.33E-01	4.50E-01	1.13E+00	3.01E+00	4.97E+00	7.46E+00	8.97E+00	2.00E+01	2.00E+01
Nonmetropolitan	0	0	0.00												
Suburban	1477000	82	1.71	5.61E+00	9.14E-01	7.82E-02	1.14E-01	2.47E-01	5.17E-01	1.81E+00	8.12E+00	1.79E+01	2.38E+01	4.79E+01	4.79E+01
Race															
Black	200000	8	0.92	*	*	*	*	*	*	*	*	*	*	*	*
White	2330000	117	1.48	4.93E+00	6.31E-01	7.82E-02	1.50E-01	2.84E-01	7.82E-01	2.34E+00	5.34E+00	1.41E+01	1.97E+01	3.22E+01	4.79E+01
Region															
Midwest	64000	4	0.14	*	*	*	*	*	*	*	*	*	*	*	*
Northeast	0	0	0.00												
South	1240000	55	1.93	5.18E+00	7.37E-01	1.57E-01	3.76E-01	6.44E-01	1.60E+00	3.42E+00	6.50E+00	1.41E+01	1.97E+01	2.38E+01	2.38E+01
West	1226000	66	3.40	4.56E+00	9.79E-01	7.82E-02	1.14E-01	2.35E-01	3.69E-01	1.42E+00	4.53E+00	1.24E+01	2.00E+01	4.79E+01	4.79E+01
Response to Questionnaire															
Households who garden	2151000	102	3.16	4.55E+00	6.61E-01	7.82E-02	1.50E-01	2.84E-01	7.56E-01	1.99E+00	4.99E+00	1.24E+01	1.79E+01	3.22E+01	4.79E+01
Households who farm	130000	5	1.77	*	*	*	*	*	*	*	*	*	*	*	*
* Intake data not provided for subpopulations for which there were less than 20 observations															
NOTE: SE = standard error P = percentile of the distributions Nc wgted = weighted number of consumers; Nc unwtgd = unweighted number of consumers in survey.															
Sources: Based on EPA's analyses of the 1987-88 NFCS															



Table 13-70. Consumer Only Intake of Homegrown Other Fruit (g/kg-day)

Population Group	Nc wtgd	Nc unwtgd	% Consuming	Mean	SE	P1	P5	P10	P25	P50	P75	P90	P95	P99	P100
Total	12615000	706	6.71	2.20E+00	1.86E-01	5.41E-02	1.47E-01	2.55E-01	4.60E-01	9.06E-01	1.91E+00	4.59E+00	8.12E+00	1.84E+01	6.26E+01
Age															
01-02	306000	19	5.37	*	*	*	*	*	*	*	*	*	*	*	*
03-05	499000	31	6.16	2.66E+00	7.60E-01	0.00E+00	0.00E+00	3.80E-01	1.02E+00	1.87E+00	2.71E+00	5.54E+00	6.30E+00	3.32E+01	3.32E+01
06-11	915000	68	5.48	2.60E+00	4.38E-01	0.00E+00	1.77E-01	3.86E-01	6.37E-01	1.14E+00	2.99E+00	7.13E+00	1.21E+01	1.62E+01	1.65E+01
12-19	1021000	54	4.98	1.62E+00	2.77E-01	8.40E-02	1.20E-01	2.57E-01	3.86E-01	6.09E-01	2.36E+00	3.92E+00	6.81E+00	8.12E+00	8.12E+00
20-39	2761000	146	4.48	1.85E+00	3.72E-01	7.94E-02	1.30E-01	1.80E-01	3.07E-01	6.20E-01	1.39E+00	3.70E+00	6.64E+00	3.70E+01	3.70E+01
40-69	4610000	259	8.13	2.09E+00	3.08E-01	6.52E-02	1.47E-01	2.54E-01	4.44E-01	7.68E-01	1.77E+00	3.17E+00	9.77E+00	1.84E+01	5.33E+01
70 +	2326000	119	14.65	1.66E+00	1.84E-01	4.41E-02	2.07E-01	3.56E-01	5.71E-01	1.07E+00	1.65E+00	4.06E+00	5.21E+00	1.17E+01	1.17E+01
Season															
Fall	2923000	102	6.13	1.39E+00	1.14E-01	2.59E-01	3.04E-01	3.81E-01	5.67E-01	1.07E+00	1.88E+00	2.89E+00	4.06E+00	5.39E+00	5.54E+00
Spring	2526000	268	5.47	1.47E+00	1.51E-01	8.66E-02	1.98E-01	2.54E-01	4.25E-01	8.33E-01	1.65E+00	2.89E+00	4.59E+00	8.26E+00	3.32E+01
Summer	4327000	144	9.51												
Winter	2839000	192	5.83	1.29E+00	1.08E-01	4.15E-02	1.01E-01	2.25E-01	4.54E-01	8.33E-01	1.55E+00	2.70E+00	4.79E+00	8.06E+00	1.13E+01
Urbanization															
Central City	2681000	102	4.76	1.79E+00	2.88E-01	4.41E-02	1.66E-01	2.91E-01	5.21E-01	8.87E-01	1.60E+00	2.61E+00	1.04E+01	1.54E+01	1.54E+01
Nonmetropolitan	4118000	278	9.15	2.43E+00	3.10E-01	6.52E-02	1.20E-01	2.38E-01	4.50E-01	1.13E+00	2.43E+00	4.60E+00	8.12E+00	2.40E+01	5.33E+01
Suburban	5756000	324	6.65	2.25E+00	3.06E-01	1.25E-01	1.99E-01	2.82E-01	4.46E-01	7.64E-01	1.81E+00	4.72E+00	7.61E+00	1.84E+01	6.26E+01
Race															
Black	250000	12	1.15	*	*	*	*	*	*	*	*	*	*	*	*
White	12256000	690	7.78	2.24E+00	1.91E-01	6.96E-02	1.50E-01	2.59E-01	4.66E-01	9.16E-01	1.94E+00	4.65E+00	8.26E+00	1.84E+01	6.26E+01
Region															
Midwest	4619000	298	9.96	3.07E+00	4.25E-01	4.41E-02	1.25E-01	2.35E-01	4.54E-01	1.04E+00	2.35E+00	6.73E+00	1.42E+01	5.33E+01	6.26E+01
Northeast	1279000	72	3.11	9.32E-01	2.20E-01	7.98E-02	8.55E-02	1.62E-01	3.11E-01	4.75E-01	8.12E-01	1.29E+00	2.16E+00	1.17E+01	1.17E+01
South	3004000	157	4.67	1.99E+00	2.59E-01	7.94E-02	2.38E-01	2.99E-01	5.46E-01	1.10E+00	1.82E+00	4.06E+00	6.30E+00	1.62E+01	2.40E+01
West	3653000	177	10.13	1.76E+00	1.64E-01	1.00E-01	2.16E-01	2.91E-01	5.44E-01	9.71E-01	2.04E+00	4.35E+00	5.75E+00	1.30E+01	1.30E+01
Response to Questionnaire															
Households who garden	10926000	619	16.03	2.38E+00	2.12E-01	4.41E-02	1.58E-01	2.57E-01	4.74E-01	9.94E-01	1.96E+00	4.94E+00	1.04E+01	1.84E+01	6.26E+01
Households who farm	1917000	112	26.16	2.57E+00	2.65E-01	6.96E-02	2.76E-01	3.61E-01	7.33E-01	1.55E+00	3.62E+00	5.80E+00	8.06E+00	1.62E+01	1.62E+01

\* Intake data not provided for subpopulations for which there were less than 20 observations

NOTE: SE = standard error  
P = percentile of the distribution  
Nc wtgd = weighted number of consumers; Nc unwtgd = unweighted number of consumers in survey.  
Source: Based on EPA's analyses of the 1987-88 NFCS



Table 13-71. Fraction of Food Intake that is Home Produced

	Total Fruits	Total Vegetables	Total Meats	Total Dairy	Total Fish	Exposed Vegetables	Protected Vegetables	Root Vegetables	Exposed Fruits	Protected Fruits
Total	0.040	0.068	0.024	0.012	0.094	0.095	0.069	0.043	0.050	0.037
<u>Season</u>										
Fall	0.021	0.081	0.020	0.008	0.076	0.106	0.073	0.06	0.039	0.008
Spring	0.021	0.037	0.020	0.011	0.160	0.05	0.039	0.02	0.047	0.008
Summer	0.058	0.116	0.034	0.022	0.079	0.164	0.101	0.066	0.068	0.054
Winter	0.059	0.041	0.022	0.008	0.063	0.052	0.048	0.026	0.044	0.068
<u>Urbanization</u>										
Central City	0.027	0.027	0.003	0.000	0.053	0.037	0.027	0.016	0.030	0.026
Nonmetropolitan	0.052	0.144	0.064	0.043	0.219	0.207	0.134	0.088	0.100	0.025
Suburban	0.047	0.058	0.018	0.004	0.075	0.079	0.054	0.035	0.043	0.050
<u>Race</u>										
Black	0.007	0.027	0.001	0.000	0.063	0.037	0.029	0.012	0.008	0.007
White	0.049	0.081	0.031	0.014	0.110	0.109	0.081	0.050	0.059	0.045
<u>Regions</u>										
Northeast	0.005	0.038	0.009	0.010	0.008	0.062	0.016	0.018	0.010	0.002
Midwest	0.059	0.112	0.046	0.024	0.133	0.148	0.109	0.077	0.078	0.048
South	0.042	0.069	0.017	0.006	0.126	0.091	0.077	0.042	0.040	0.044
West	0.062	0.057	0.023	0.007	0.108	0.079	0.060	0.029	0.075	0.054
<u>Questionnaire Response</u>										
Households who garden	0.101	0.173				0.233	0.178	0.106	0.116	0.094
Households who raise animals			0.306	0.207						
Households who farm	0.161	0.308	0.319	0.254		0.420	0.394	0.173	0.328	0.030
Households who fish					0.325					

Table 13-71. Fraction of Food Intake that is Home Produced (continued)

	Dark Green Vegetables	Deep Yellow Vegetables	Other Vegetables	Citrus Fruits	Other Fruits	Apples	Peaches	Pears	Strawberries	Other Berries
Total	0.044	0.065	0.069	0.038	0.042	0.030	0.147	0.067	0.111	0.217
<u>Season</u>										
Fall	0.059	0.099	0.069	0.114	0.027	0.032	0.09	0.038	0.408	0.163
Spring	0.037	0.017	0.051	0.014	0.025	0.013	0.206	0.075	0.064	0.155
Summer	0.063	0.08	0.114	0.01	0.07	0.053	0.133	0.066	0.088	0.232
Winter	0.018	0.041	0.044	0.091	0.03	0.024	0.183	0.111	0.217	0.308
<u>Urbanization</u>										
Central City	0.012	0.038	0.026	0.035	0.022	0.017	0.087	0.038	0.107	0.228
Nonmetropolitan	0.090	0.122	0.154	0.000	0.077	0.066	0.272	0.155	0.133	0.282
Suburban	0.054	0.058	0.053	0.056	0.042	0.024	0.121	0.068	0.101	0.175
<u>Race</u>										
Black	0.053	0.056	0.026	0.012	0.004	0.007	0.018	0.004	0.000	0.470
White	0.043	0.071	0.082	0.045	0.051	0.035	0.164	0.089	0.125	0.214
<u>Regions</u>										
Northeast	0.039	0.019	0.034	0.000	0.008	0.004	0.027	0.002	0.085	0.205
Midwest	0.054	0.174	0.102	0.001	0.083	0.052	0.164	0.112	0.209	0.231
South	0.049	0.022	0.077	0.060	0.031	0.024	0.143	0.080	0.072	0.177
West	0.034	0.063	0.055	0.103	0.046	0.043	0.238	0.093	0.044	0.233
<u>Questionnaire Response</u>										
Households who garden	0.120	0.140	0.180	0.087	0.107	0.070	0.316	0.169	0.232	0.306
Households who farm	0.220	0.328	0.368	0.005	0.227	0.292	0.461	0.606	0.057	0.548



Table 13-71. Fraction of food Intake that is Home Produced (continued)

	Asparagus	Beets	Broccoli	Cabbage	Carrots	Corn	Cucumbers	Lettuce	Lima Beans	Okra	Onions
Total	0.063	0.203	0.015	0.038	0.043	0.078	0.148	0.010	0.121	0.270	0.056
<u>Season</u>											
Fall	0.024	0.199	0.013	0.054	0.066	0.076	0.055	0.013	0.07	0.299	0.066
Spring	0.103	0.191	0.011	0.011	0.015	0.048	0.04	0.01	0.082	0.211	0.033
Summer	0	0.209	0.034	0.08	0.063	0.118	0.32	0.017	0.176	0.304	0.091
Winter	0.019	0.215	0.006	0.008	0.025	0.043	0	0.002	0.129	0.123	0.029
<u>Urbanization</u>											
Central City	0.058	0.212	0.004	0.004	0.018	0.025	0.029	0.009	0.037	0.068	0.017
Nonmetropolitan	0.145	0.377	0.040	0.082	0.091	0.173	0.377	0.017	0.132	0.411	0.127
Suburban	0.040	0.127	0.016	0.045	0.039	0.047	0.088	0.009	0.165	0.299	0.050
<u>Race</u>											
Black	0.000	0.000	0.000	0.001	0.068	0.019	0.060	0.007	0.103	0.069	0.009
White	0.071	0.224	0.018	0.056	0.042	0.093	0.155	0.011	0.135	0.373	0.068
<u>Regions</u>											
Northeast	0.091	0.074	0.020	0.047	0.025	0.020	0.147	0.009	0.026	0.000	0.022
Midwest	0.194	0.432	0.025	0.053	0.101	0.124	0.193	0.020	0.149	0.224	0.098
South	0.015	0.145	0.013	0.029	0.020	0.088	0.140	0.006	0.140	0.291	0.047
West	0.015	0.202	0.006	0.029	0.039	0.069	0.119	0.009	0.000	0.333	0.083
<u>Questionnaire Response</u>											
Households who garden	0.125	0.420	0.043	0.099	0.103	0.220	0.349	0.031	0.258	0.618	0.148
Households who farm	0.432	0.316	0.159	0.219	0.185	0.524	0.524	0.063	0.103	0.821	0.361

Table 13-71. Fraction of Food Intake that is Home Produced (continued)

	Peas	Peppers	Pumpkin	Snap Beans	Tomatoes	White Potatoes	Beef	Game	Pork	Poultry	Eggs
Total	0.069	0.107	0.155	0.155	0.184	0.038	0.038	0.276	0.013	0.011	0.014
<u>Season</u>											
Fall	0.046	0.138	0.161	0.199	0.215	0.058	0.028	0.336	0.012	0.011	0.009
Spring	0.048	0.031	0.046	0.152	0.045	0.01	0.027	0.265	0.015	0.012	0.022
Summer	0.126	0.194	0.19	0.123	0.318	0.06	0.072	0.1	0.01	0.007	0.013
Winter	0.065	0.03	0.154	0.147	0.103	0.022	0.022	0.33	0.014	0.014	0.011
<u>Urbanization</u>											
Central City	0.033	0.067	0.130	0.066	0.100	0.009	0.001	0.146	0.001	0.002	0.002
Nonmetropolitan	0.123	0.228	0.250	0.307	0.313	0.080	0.107	0.323	0.040	0.026	0.029
Suburban	0.064	0.086	0.127	0.118	0.156	0.029	0.026	0.316	0.006	0.011	0.014
<u>Race</u>											
Black	0.047	0.039	0.022	0.046	0.060	0.007	0.000	0.000	0.000	0.001	0.002
White	0.076	0.121	0.187	0.186	0.202	0.044	0.048	0.359	0.017	0.014	0.017
<u>Regions</u>											
Northeast	0.021	0.067	0.002	0.052	0.117	0.016	0.014	0.202	0.006	0.002	0.004
Midwest	0.058	0.188	0.357	0.243	0.291	0.065	0.076	0.513	0.021	0.021	0.019
South	0.106	0.113	0.044	0.161	0.149	0.042	0.022	0.199	0.012	0.012	0.012
West	0.051	0.082	0.181	0.108	0.182	0.013	0.041	0.207	0.011	0.008	0.021
<u>Questionnaire Response</u>											
Households who garden	0.193	0.246	0.230	0.384	0.398	0.090					
Households who farm	0.308	0.564	0.824	0.623	0.616	0.134	0.485		0.242	0.156	0.146
Households who raise animals							0.478		0.239	0.151	0.214
Households who hunt								0.729			

Source: Based on EPA's analyses of the 1987-88 NFCS



Table 13-72. Confidence in Homegrown Food Consumption Recommendations

Considerations	Rationale	Rating
<b>Study Elements</b>		
• Level of Peer Review	USDA and EPA review	High
• Accessibility	Methods described in detail in Handbook	High
• Reproducibility	see above	High
• Focus on factor of interest	Yes	High
• Data pertinent to U.S.	U.S. population	High
• Primary data	Yes	High
• Currency	1987-88	Medium
• Adequacy of data collection period	Statistical method used to estimate long-term distribution from one-week survey data.	High (Means & Short-term distributions) Low (Long-term distributions)
• Validity of approach	Individual intakes inferred from household consumption.	Medium (Means) Low (Distributions)
• Study size	10,000 individuals, 4500 households	High
• Representativeness of the population	Nationwide survey representative of general U.S. population	High
• Bias in study design (high rating desirable)	Non-response bias can not be ruled out due to low response rate.	Medium
• Measurement Error (high rating desirable)	Individuals' estimates of food weights imprecise	Medium
<b>Other Elements</b>		
• Number of studies	1	Low
• Agreement between researchers	N/A	
<b>Overall Rating</b>	Highest confidence in means, lowest confidence in long term percentiles	<b>Medium</b> (Means) <b>Medium</b> (Short-term distributions) <b>Low</b> (Long-term distributions)



**APPENDIX 13A**

**FOOD CODES AND DEFINITIONS USED IN ANALYSIS  
OF THE 1987-88 USDA NFCS DATA**



Appendix 13A

Appendix 13A. Food Codes and Definitions Used in Analysis of the 1987-88 USDA NFCS Data

Food Product	Household Code/Definition	Individual Code
<b>MAJOR FOOD GROUPS</b>		
Total Fruits	50- Fresh Fruits citrus other vitamin-C rich other fruits 512- Commercially Canned Fruits 522- Commercially Frozen Fruits 533- Canned Fruit Juice 534- Frozen Fruit Juice 535- Aseptically Packed Fruit Juice 536- Fresh Fruit Juice 542- Dried Fruits (includes baby foods)	6- Fruits citrus fruits and juices dried fruits other fruits fruits/juices & nectar fruit/juices baby food (includes baby foods)
Total Vegetables	48- Potatoes, Sweetpotatoes 49- Fresh Vegetables dark green deep yellow tomatoes light green other 511- Commercially Canned Vegetables 521- Commercially Frozen Vegetables 531- Canned Vegetable Juice 532- Frozen Vegetable Juice 537- Fresh Vegetable Juice 538- Aseptically Packed Vegetable Juice 541- Dried Vegetables (does not include soups, sauces, gravies, mixtures, and ready-to-eat dinners; includes baby foods except mixtures/dinners)	7- Vegetables (all forms) white potatoes & PR starchy dark green vegetables deep yellow vegetables tomatoes and tom. mixtures other vegetables veg. and mixtures/baby food veg. with meat mixtures (includes baby foods; mixtures, mostly vegetables)
Total Meats	44- Meat beef pork veal lamb mutton goat game lunch meat mixtures 451- Poultry (does not include soups, sauces, gravies, mixtures, and ready-to-eat dinners; includes baby foods except mixtures)	20- Meat, type not specified 21- Beef 22- Pork 23- Lamb, veal, game, carcass meat 24- Poultry 25- Organ meats, sausages, lunchmeats, meat spreads (excludes meat, poultry, and fish with non-meat items; frozen plate meals; soups and gravies with meat, poultry and fish base; and gelatin-based drinks; includes baby foods)
Total Dairy	40- Milk Equivalent fresh fluid milk processed milk cream and cream substitutes frozen desserts with milk cheese dairy-based dips (does not include soups, sauces, gravies, mixtures, and ready-to-eat dinners)	1- Milk and Milk Products milk and milk drinks cream and cream substitutes milk desserts, sauces, and gravies cheeses (includes regular fluid milk, human milk, imitation milk products, yogurt, milk-based meal replacements, and infant formulas)





Appendix 13A. Food Codes and Definitions Used in Analysis of the 1987-88 USDA NFCS Data (continued)

Food Product	Household Code/Definition	Individual Code
Total Fish	452- Fish, Shellfish various species fresh, frozen, commercial, dried (does not include soups, sauces, gravies, mixtures, and ready-to-eat dinners)	26- Fish, Shellfish various species and forms  (excludes meat, poultry, and fish with non-meat items; frozen plate meals; soups and gravies with meat, poultry and fish base; and gelatin-based drinks)
<b>INDIVIDUAL FOODS</b>		
White Potatoes	4811- White Potatoes, fresh 4821- White Potatoes, commercially canned 4831- White Potatoes, commercially frozen 4841- White Potatoes, dehydrated 4851- White Potatoes, chips, sticks, salad (does not include soups, sauces, gravies, mixtures, and ready-to-eat dinners)	71- White Potatoes and PR Starchy Veg. baked, boiled, chips, sticks, creamed, scalloped, au gratin, fried, mashed, stuffed, puffs, salad, recipes, soups, Puerto Rican starchy vegetables (does not include vegetables soups; vegetable mixtures; or vegetable with meat mixtures)
Peppers	4913- Green/Red Peppers, fresh 5111201 Sweet Green Peppers, commercially canned 5111202 Hot Chili Peppers, commercially canned 5211301 Sweet Green Peppers, commercially frozen 5211302 Green Chili Peppers, commercially frozen 5211303 Red Chili Peppers, commercially frozen 5413112 Sweet Green Peppers, dry 5413113 Red Chili Peppers, dry (does not include soups, sauces, gravies, mixtures, and ready-to-eat dinners)	7512100 Pepper, hot chili, raw 7512200 Pepper, raw 7512210 Pepper, sweet green, raw 7512220 Pepper, sweet red, raw 7522600 Pepper, green, cooked, NS as to fat added 7522601 Pepper, green, cooked, fat not added 7522602 Pepper, green, cooked, fat added 7522604 Pepper, red, cooked, NS as to fat added 7522605 Pepper, red, cooked, fat not added 7522606 Pepper, red, cooked, fat added 7522609 Pepper, hot, cooked, NS as to fat added 7522610 Pepper, hot, cooked, fat not added 7522611 Pepper, hot, cooked, fat added 7551101 Peppers, hot, sauce 7551102 Peppers, pickled (does not include vegetable soups; vegetable mixtures; or vegetable with meat mixtures)
Onions	4953- Onions, Garlic, fresh onions chives garlic leeks 5114908 Garlic Pulp, raw 5114915 Onions, commercially canned 5213722 Onions, commercially frozen 5213723 Onions with Sauce, commercially frozen 5413103 Chives, dried 5413105 Garlic Flakes, dried 5413110 Onion Flakes, dried (does not include soups, sauces, gravies, mixtures, and ready-to-eat dinners)	7510950 Chives, raw 7511150 Garlic, raw 7511250 Leek, raw 7511701 Onions, young green, raw 7511702 Onions, mature 7521550 Chives, dried 7521740 Garlic, cooked 7522100 Onions, mature cooked, NS as to fat added 7522101 Onions, mature cooked, fat not added 7522102 Onions, mature cooked, fat added 7522103 Onions, pearl cooked 7522104 Onions, young green cooked, NS as to fat 7522105 Onions, young green cooked, fat not added 7522106 Onions, young green cooked, fat added 7522110 Onion, dehydrated 7541501 Onions, creamed 7541502 Onion rings (does not include vegetable soups; vegetable mixtures; or vegetable with meat mixtures)



Appendix 13A

Appendix 13A. Food Codes and Definitions Used in Analysis of the 1987-88 USDA NFCS Data (continued)

Food Product	Household Code/Definition	Individual Code
Corn	4956- Corn, fresh 5114601 Yellow Corn, commercially canned 5114602 White Corn, commercially canned 5114603 Yellow Creamed Corn, commercially canned 5114604 White Creamed Corn, commercially canned 5114605 Corn on Cob, commercially canned 5114607 Hominy, canned 5115306 Low Sodium Corn, commercially canned 5115307 Low Sodium Cr. Corn, commercially canned 5213501 Yellow Corn on Cob, commercially frozen 5213502 Yellow Corn off Cob, commercially frozen 5213503 Yell. Corn with Sauce, commercially frozen 5213504 Corn with other Veg., commercially frozen 5213505 White Corn on Cob, commercially frozen 5213506 White Corn off Cob, commercially frozen 5213507 Wh. Corn with Sauce, commercially frozen 5413104 Corn, dried 5413106 Hominy, dry 5413603 Corn, instant baby food (does not include soups, sauces, gravies, mixtures, and ready-to-eat dinners; includes baby food)	7510960 Corn, raw 7521600 Corn, cooked, NS as to color/fat added 7521601 Corn, cooked, NS as to color/fat not added 7521602 Corn, cooked, NS as to color/fat added 7521605 Corn, cooked, NS as to color/cream style 7521607 Corn, cooked, dried 7521610 Corn, cooked, yellow/NS as to fat added 7521611 Corn, cooked, yellow/fat not added 7521612 Corn, cooked, yellow/fat added 7521615 Corn, yellow, cream style 7521616 Corn, cooked, yell. & wh./NS as to fat 7521617 Corn, cooked, yell. & wh./fat not added 7521618 Corn, cooked, yell. & wh./fat added 7521619 Corn, yellow, cream style, fat added 7521620 Corn, cooked, white/NS as to fat added 7521621 Corn, cooked, white/fat not added 7521622 Corn, cooked, white/fat added 7521625 Corn, white, cream style 7521630 Corn, yellow, canned, low sodium, NS fat 7521631 Corn, yell., canned, low sod., fat not add 7521632 Corn, yell., canned, low sod., fat added 7521749 Hominy, cooked 752175- Hominy, cooked 7541101 Corn scalloped or pudding 7541102 Corn fritter 7541103 Corn with cream sauce 7550101 Corn relish 76405- Corn, baby (does not include vegetable soups; vegetable mixtures; or vegetable with meat mixtures; includes baby food)



Appendix 13A. Food Codes and Definitions Used in Analysis of the 1987-88 USDA NFCS Data (continued)

Food Product	Household Code/Definition	Individual Code
Apples	5031- Apples, fresh 5122101 Applesauce with sugar, commercially canned 5122102 Applesauce without sugar, comm. canned 5122103 Apple Pie Filling, commercially canned 5122104 Apples, Applesauce, baby/jr., comm. canned 5122106 Apple Pie Filling, Low Cal., comm. canned 5223101 Apple Slices, commercially frozen 5332101 Apple Juice, canned 5332102 Apple Juice, baby, Comm. canned 5342201 Apple Juice, comm. frozen 5342202 Apple Juice, home frozen 5352101 Apple Juice, aseptically packed 5362101 Apple Juice, fresh 5423101 Apples, dried (includes baby food; except mixtures)	6210110 Apples, dried, uncooked 6210115 Apples, dried, uncooked, low sodium 6210120 Apples, dried, cooked, NS as to sweetener 6210122 Apples, dried, cooked, unsweetened 6210123 Apples, dried, cooked, with sugar 6310100 Apples, raw 6310111 Applesauce, NS as to sweetener 6310112 Applesauce, unsweetened 6310113 Applesauce with sugar 6310114 Applesauce with low calorie sweetener 6310121 Apples, cooked or canned with syrup 6310131 Apple, baked NS as to sweetener 6310132 Apple, baked, unsweetened 6310133 Apple, baked with sugar 6310141 Apple rings, fried 6310142 Apple, pickled 6310150 Apple, fried 6340101 Apple, salad 6340106 Apple, candied 6410101 Apple cider 6410401 Apple juice 6410405 Apple juice with vitamin C 6710200 Applesauce baby fd., NS as to str. or jr. 6710201 Applesauce baby food, strained 6710202 Applesauce baby food, junior 6720200 Apple juice, baby food (includes baby food; except mixtures)
Tomatoes	4931- Tomatoes, fresh 5113- Tomatoes, commercially canned 5115201 Tomatoes, low sodium, commercially canned 5115202 Tomato Sauce, low sodium, comm. canned 5115203 Tomato Paste, low sodium, comm. canned 5115204 Tomato Puree, low sodium, comm. canned 5311- Canned Tomato Juice and Tomato Mixtures 5321- Frozen Tomato Juice 5371- Fresh Tomato Juice 5381102 Tomato Juice, aseptically packed 5413115 Tomatoes, dry 5614- Tomato Soup 5624- Condensed Tomato Soup 5654- Dry Tomato Soup (does not include mixtures, and ready-to-eat dinners)	74- Tomatoes and Tomato Mixtures raw, cooked, juices, sauces, mixtures, soups, sandwiches



Appendix 13A

Appendix 13A. Food Codes and Definitions Used in Analysis of the 1987-88 USDA NFCS Data (continued)

Food Product	Household Code/Definition	Individual Code
Snap Beans	4943- Snap or Wax Beans, fresh 5114401 Green or Snap Beans, commercially canned 5114402 Wax or Yellow Beans, commercially canned 5114403 Beans, baby/jr., commercially canned 5115302 Green Beans, low sodium, comm. canned 5115303 Yell. or Wax Beans, low sod., comm. canned 5213301 Snap or Green Beans, comm. frozen 5213302 Snap or Green w/sauce, comm. frozen 5213303 Snap or Green Beans w/other veg., comm. fr. 5213304 Sp. or Gr. Beans w/other veg./sc., comm. fr. 5213305 Wax or Yell. Beans, comm. frozen (does not include soups, mixtures, and ready-to-eat dinners; includes baby foods)	7510180 Beans, string, green, raw 7520498 Beans, string, cooked, NS color/fat added 7520499 Beans, string, cooked, NS color/no fat 7520500 Beans, string, cooked, NS color & fat 7520501 Beans, string, cooked, green/NS fat 7520502 Beans, string, cooked, green/no fat 7520503 Beans, string, cooked, green/fat 7520511 Beans, str., canned, low sod..green/NS fat 7520512 Beans, str., canned, low sod..green/no fat 7520513 Beans, str., canned, low sod..green/fat 7520600 Beans, string, cooked, yellow/NS fat 7520601 Beans, string, cooked, yellow/no fat 7520602 Beans, string, cooked, yellow/fat 7540301 Beans, string, green, creamed 7540302 Beans, string, green, w/mushroom sauce 7540401 Beans, string, yellow, creamed 7550011 Beans, string, green, pickled 7640100 Beans, green, string, baby 7640101 Beans, green, string, baby, str. 7640102 Beans, green, string, baby, junior 7640103 Beans, green, string, baby, creamed (does not include vegetable soups; vegetable mixtures; or vegetable with meat mixtures; includes baby foods)
Beef	441- Beef (does not include soups, sauces, gravies, mixtures, and ready-to-eat dinners; includes baby foods except mixtures)	21- Beef beef, nfs beef steak beef oxtails, neckbones, ribs roasts, stew meat, corned, brisket, sandwich steaks ground beef, patties, meatballs other beef items beef baby food (excludes meat, poultry, and fish with non-meat items; frozen plate meals; soups and gravies with meat, poultry and fish base; and gelatin-based drinks; includes baby food)
Pork	442- Pork (does not include soups, sauces, gravies, mixtures, and ready-to-eat dinners; includes baby foods except mixtures)	22- Pork pork, nfs; ground dehydrated chops steaks, cutlets ham roasts Canadian bacon bacon, salt pork other pork items pork baby food (excludes meat, poultry, and fish with non-meat items; frozen plate meals; soups and gravies with meat, poultry and fish base; and gelatin-based drinks; includes baby food)
Game	445- Variety Meat, Game (does not include soups, sauces, gravies, mixtures, and ready-to-eat dinners; includes baby foods except mixtures)	233- Game (excludes meat, poultry, and fish with non-meat items; frozen plate meals; soups and gravies with meat, poultry and fish base; and gelatin-based drinks)



Appendix 13A. Food Codes and Definitions Used in Analysis of the 1987-88 USDA NFCS Data (continued)

Food Product	Household Code/Definition	Individual Code
Poultry	451- Poultry (does not include soups, sauces, gravies, mixtures, and ready-to-eat dinners; includes baby foods except mixtures)	24- Poultry chicken turkey duck other poultry poultry baby food (excludes meat, poultry, and fish with non-meat items; frozen plate meals; soups and gravies with meat, poultry and fish base; and gelatin-based drinks; includes baby food)
Eggs	46- Eggs (fresh equivalent) fresh processed eggs, substitutes (does not include soups, sauces, gravies, mixtures, and ready-to-eat dinners; includes baby foods except mixtures)	3- Eggs eggs egg mixtures egg substitutes eggs baby food froz. meals with egg as main ingred. (includes baby foods)
Broccoli	4912- Fresh Broccoli (and home canned/froz.) 5111203 Broccoli, comm. canned 52112- Comm. Frozen Broccoli (does not include soups, sauces, gravies, mixtures, and ready-to-eat dinners; includes baby foods except mixtures)	722- Broccoli (all forms) (does not include vegetable soups; vegetable mixtures; or vegetable with meat mixtures)
Carrots	4921- Fresh Carrots (and home canned/froz.) 51121- Comm. Canned Carrots 5115101 Carrots, Low Sodium, Comm. Canned 52121- Comm. Frozen Carrots 5312103 Comm. Canned Carrot Juice 5372102 Carrot Juice Fresh 5413502 Carrots, Dried Baby Food (does not include soups, sauces, gravies, mixtures, and ready-to-eat dinners; includes baby foods except mixtures)	7310- Carrots (all forms) 7311140 Carrots in Sauce 7311200 Carrot Chips 76201- Carrots, baby (does not include vegetable soups; vegetable mixtures; or vegetable with meat mixtures; includes baby foods except mixtures)
Pumpkin	4922- Fresh Pumpkin, Winter Squash (and home canned/froz.) 51122- Pumpkin/Squash, Baby or Junior, Comm. Canned 52122- Winter Squash, Comm. Frozen 5413504 Squash, Dried Baby Food (does not include soups, sauces, gravies, mixtures, and ready-to-eat dinners; includes baby foods except mixtures)	732- Pumpkin (all forms) 733- Winter squash (all forms) 76205- Squash, baby (does not include vegetable soups; vegetables mixtures; or vegetable with meat mixtures; includes baby foods)
Asparagus	4941- Fresh Asparagus (and home canned/froz.) 5114101 Comm. Canned Asparagus 5115301 Asparagus, Low Sodium, Comm. Canned 52131- Comm. Frozen Asparagus (does not include soups, sauces, gravies, mixtures, and ready-to-eat dinners; includes baby foods except mixtures)	7510080 Asparagus, raw 75202- Asparagus, cooked 7540101 Asparagus, creamed or with cheese (does not include vegetable soups; vegetables mixtures, or vegetable with meat mixtures)



Appendix 13A

Appendix 13A. Food Codes and Definitions Used in Analysis of the 1987-88 USDA NFCS Data (continued)

Food Product	Household Code/Definition	Individual Code
Lima Beans	4942- Fresh Lima and Fava Beans (and home canned/froz.) 5114204 Comm. Canned Mature Lima Beans 5114301 Comm. Canned Green Lima Beans 5115304 Comm. Canned Low Sodium Lima Beans 52132- Comm. Frozen Lima Beans 54111- Dried Lima Beans 5411306 Dried Fava Beans (does not include soups, sauces, gravies, mixtures, and ready-to-eat dinners; includes baby foods except mixtures; does not include succotash)	7510200 Lima Beans, raw 752040- Lima Beans, cooked 752041- Lima Beans, canned 75402- Lima Beans with sauce (does not include vegetable soups; vegetable mixtures; or vegetable with meat mixtures; does not include succotash)
Cabbage	4944- Fresh Cabbage (and home canned/froz.) 4958601 Sauerkraut, home canned or pkgd 5114801 Sauerkraut, comm. canned 5114904 Comm. Canned Cabbage 5114905 Comm. Canned Cabbage (no sauce; incl. baby) 5115501 Sauerkraut, low sodium., comm. canned 5312102 Sauerkraut Juice, comm. canned (does not include soups, sauces, gravies, mixtures, and ready-to-eat dinners; includes baby foods except mixtures)	7510300 Cabbage, raw 7510400 Cabbage, Chinese, raw 7510500 Cabbage, red, raw 7514100 Cabbage salad or coleslaw 7514130 Cabbage, Chinese, salad 75210- Chinese Cabbage, cooked 75211- Green Cabbage, cooked 75212- Red Cabbage, cooked 752130- Savoy Cabbage, cooked 75230- Sauerkraut, cooked 7540701 Cabbage, creamed 755025- Cabbage, pickled or in relish (does not include vegetable soups; vegetable mixtures; or vegetable with meat mixtures)
Lettuce	4945- Fresh Lettuce, French Endive (and home canned/froz.) (does not include soups, sauces, gravies, mixtures, and ready-to-eat dinners; includes baby foods except mixtures)	75113- Lettuce, raw 75143- Lettuce salad with other veg. 7514410 Lettuce, wilted, with bacon dressing 7522005 Lettuce, cooked (does not include vegetable soups; vegetable mixtures; or vegetable with meat mixtures)
Okra	4946- Fresh Okra (and home canned/froz.) 5114914 Comm. Canned Okra 5213720 Comm. Frozen Okra 5213721 Comm. Frozen Okra with Oth. Veg. & Sauce (does not include soups, sauces, gravies, mixtures, and ready-to-eat dinners; includes baby foods except mixtures)	7522000 Okra, cooked, NS as to fat 7522001 Okra, cooked, fat not added 7522002 Okra, cooked, fat added 7522010 Lufta, cooked (Chinese Okra) 7541450 Okra, fried 7550700 Okra, pickled (does not include vegetable soups; vegetable mixtures; or vegetable with meat mixtures)
Peas	4947- Fresh Peas (and home canned/froz.) 51147- Comm Canned Peas (incl. baby) 5115310 Low Sodium Green or English Peas (canned) 5115314 Low Sod. Blackeye, Gr. or Imm. Peas (canned) 5114205 Blackeyed Peas, comm. canned 52134- Comm. Frozen Peas 5412- Dried Peas and Lentils (does not include soups, sauces, gravies, mixtures, and ready-to-eat dinners; includes baby foods except mixtures)	7512000 Peas, green, raw 7512775 Snowpeas, raw 75223- Peas, cowpeas, field or blackeye, cooked 75224- Peas, green, cooked 75225- Peas, pigeon, cooked 75231- Snowpeas, cooked 7541650 Pea salad 7541660 Pea salad with cheese 75417- Peas, with sauce or creamed 76409- Peas, baby 76411- Peas, creamed, baby (does not include vegetable soups; vegetable mixtures; or vegetable with meat mixtures; includes baby foods except mixtures)



Appendix 13A. Food Codes and Definitions Used in Analysis of the 1987-88 USDA NFCS Data (continued)

Food Product	Household Code/Definition	Individual Code
Cucumbers	4952- Fresh Cucumbers (and home canned/froz.) (does not include soups, sauces, gravies, mixtures, and ready-to-eat dinners; includes baby foods except mixtures)	7511100 Cucumbers, raw 75142- Cucumber salads 752167- Cucumbers, cooked 7550301 Cucumber pickles, dill 7550302 Cucumber pickles, relish 7550303 Cucumber pickles, sour 7550304 Cucumber pickles, sweet 7550305 Cucumber pickles, fresh 7550307 Cucumber, Kim Chee 7550311 Cucumber pickles, dill, reduced salt 7550314 Cucumber pickles, sweet, reduced salt (does not include vegetable soups; vegetable mixtures; or vegetable with meat mixtures)
Beets	4954- Fresh Beets (and home canned/froz.) 51145- Comm. Canned Beets (incl. baby) 5115305 Low Sodium Beets (canned) 5213714 Comm. Frozen Beets 5312104 Beet Juice (does not include soups, sauces, gravies, mixtures, and ready-to-eat dinners; includes baby foods except mixtures)	7510250 Beets, raw 752080- Beets, cooked 752081- Beets, canned 7540501 Beets, harvard 7550021 Beets, pickled 76403- Beets, baby (does not include vegetable soups; vegetable mixtures; or vegetable with meat mixtures; includes baby foods except mixtures)
Strawberries	5022- Fresh Strawberries 5122801 Comm. Canned Strawberries with sugar 5122802 Comm. Canned Strawberries without sugar 5122803 Canned Strawberry Pie Filling 5222- Comm. Frozen Strawberries (does not include ready-to-eat dinners; includes baby foods except mixtures)	6322- Strawberries 6413250 Strawberry Juice (includes baby food; except mixtures)
Other Berries	5033- Fresh Berries Other than Strawberries 5122804 Comm. Canned Blackberries with sugar 5122805 Comm. Canned Blackberries without sugar 5122806 Comm. Canned Blueberries with sugar 5122807 Comm. Canned Blueberries without sugar 5122808 Canned Blueberry Pie Filling 5122809 Comm. Canned Gooseberries with sugar 5122810 Comm. Canned Gooseberries without sugar 5122811 Comm. Canned Raspberries with sugar 5122812 Comm. Canned Raspberries without sugar 5122813 Comm. Canned Cranberry Sauce 5122815 Comm. Canned Cranberry-Orange Relish 52233- Comm. Frozen Berries (not strawberries) 5332404 Blackberry Juice (home and comm. canned) 5423114 Dried Berries (not strawberries) (does not include ready-to-eat dinners; includes baby foods except mixtures)	6320- Other Berries 6321- Other Berries 6341101 Cranberry salad 6410460 Blackberry Juice 64105- Cranberry Juice (includes baby food; except mixtures)



Appendix 13A

Appendix 13A. Food Codes and Definitions Used in Analysis of the 1987-88 USDA NFCS Data (continued)

Food Product	Household Code/Definition	Individual Code
Peaches	5036- Fresh Peaches 51224- Comm. Canned Peaches (incl. baby) 5223601 Comm. Frozen Peaches 5332405 Home Canned Peach Juice 5423105 Dried Peaches (baby) 5423106 Dried Peaches (does not include ready-to-eat dinners; includes baby foods except mixtures)	62116- Dried Peaches 63135- Peaches 6412203 Peach Juice 6420501 Peach Nectar 67108- Peaches,baby 6711450 Peaches, dry, baby (includes baby food; except mixtures)
Pears	5037- Fresh Pears 51225- Comm. Canned Pears (incl. baby) 5332403 Comm. Canned Pear Juice, baby 5362204 Fresh Pear Juice 5423107 Dried Pears (does not include ready-to-eat dinners; includes baby foods except mixtures)	62119- Dried Pears 63137- Pears 6341201 Pear salad 6421501 Pear Nectar 67109- Pears, baby 6711455 Pears, dry, baby (includes baby food; except mixtures)
<b>EXPOSED/PROTECTED FRUITS/VEGETABLES, ROOT VEGETABLES</b>		
Exposed Fruits	5022- Strawberries, fresh 5023101 Acerola, fresh 5023401 Currants, fresh 5031- Apples/Applesauce, fresh 5033- Berries other than Strawberries, fresh 5034- Cherries, fresh 5036- Peaches, fresh 5037- Pears, fresh 50381- Apricots, Nectarines, Loquats, fresh 5038305 Dates, fresh 50384- Grapes, fresh 50386- Plums, fresh 50387- Rhubarb, fresh 5038805 Persimmons, fresh 5038901 Sapote, fresh 51221- Apples/Applesauce, canned 51222- Apricots, canned 51223- Cherries, canned 51224- Peaches, canned 51225- Pears, canned 51228- Berries, canned 5122903 Grapes with sugar, canned 5122904 Grapes without sugar, canned 5122905 Plums with sugar, canned 5122906 Plums without sugar, canned 5122907 Plums, canned, baby 5122911 Prunes, canned, baby 5122912 Prunes, with sugar, canned 5122913 Prunes, without sugar, canned 5122914 Raisin Pie Filling 5222- Frozen Strawberries 52231- Apples Slices, frozen 52233- Berries, frozen 52234- Cherries, frozen 52236- Peaches, frozen 52239- Rhubarb, frozen 53321- Canned Apple Juice 53322- Canned Grape Juice	62101- Apple, dried 62104- Apricot, dried 62108- Currants, dried 62110- Date, dried 62116- Peaches, dried 62119- Pears, dried 62121- Plum, dried 62122- Prune, dried 62125- Raisins 63101- Apples/applesauce 63102- Wi-apple 63103- Apricots 63111- Cherries, maraschino 63112- Acerola 63113- Cherries, sour 63115- Cherries, sweet 63117- Currants, raw 63123- Grapes 6312601 Juneberry 63131- Nectarine 63135- Peach 63137- Pear 63139- Persimmons 63143- Plum 63146- Quince 63147- Rhubarb/Sapodillo 632- Berries 64101- Apple Cider 64104- Apple Juice 64105- Cranberry Juice 64116- Grape Juice 64122- Peach Juice 64132- Prune/Strawberry Juice 6420101 Apricot Nectar 64205- Peach Nectar 64215- Pear Nectar 67102- Applesauce, baby 67108- Peaches, baby





Appendix 13A. Food Codes and Definitions Used in Analysis of the 1987-88 USDA NFCS Data (continued)

Food Product	Household Code/Definition	Individual Code
Exposed Fruits (continued)	5332402 Canned Prune Juice 5332403 Canned Pear Juice 5332404 Canned Blackberry Juice 5332405 Canned Peach Juice 53421- Frozen Grape Juice 5342201 Frozen Apple Juice, comm. fr. 5342202 Frozen Apple Juice, home fr. 5352101 Apple Juice, asep. packed 5352201 Grape Juice, asep. packed 5362101 Apple Juice, fresh 5362202 Apricot Juice, fresh 5362203 Grape Juice, fresh 5362204 Pear Juice, fresh 5362205 Prune Juice, fresh 5421- Dried Prunes 5422- Raisins, Currants, dried 5423101 Dry Apples 5423102 Dry Apricots 5423103 Dates without pits 5423104 Dates with pits 5423105 Peaches, dry, baby 5423106 Peaches, dry 5423107 Pears, dry 5423114 Berries, dry 5423115 Cherries, dry (includes baby foods)	67109- Pears, baby 6711450 Peaches, baby, dry 6711455 Pears, baby, dry 67202- Apple Juice, baby 6720380 White Grape Juice, baby 67212- Pear Juice, baby (includes baby foods/juices except mixtures; excludes fruit mixtures)
Protected Fruits	501- Citrus Fruits, fresh 5021- Cantaloupe, fresh 5023201 Mangoes, fresh 5023301 Guava, fresh 5023601 Kiwi, fresh 5023701 Papayas, fresh 5023801 Passion Fruit, fresh 5032- Bananas, Plantains, fresh 5035- Melons other than Cantaloupe, fresh 50382- Avocados, fresh 5038301 Figs, fresh 5038302 Figs, cooked 5038303 Figs, home canned 5038304 Figs, home frozen 50385- Pineapple, fresh 5038801 Pomegranates, fresh 5038902 Cherimoya, fresh 5038903 Jackfruit, fresh 5038904 Breadfruit, fresh 5038905 Tamarind, fresh 5038906 Carambola, fresh 5038907 Longan, fresh 5121- Citrus, canned 51226- Pineapple, canned 5122901 Figs with sugar, canned 5122902 Figs without sugar, canned 5122909 Bananas, canned, baby 5122910 Bananas and Pineapple, canned, baby 5122915 Litchis, canned	61- Citrus Fr., Juices (incl. cit. juice mixtures) 62107- Bananas, dried 62113- Figs, dried 62114- Lychees/Papayas, dried 62120- Pineapple, dried 62126- Tamarind, dried 63105- Avocado, raw 63107- Bananas 63109- Cantaloupe, Carambola 63110- Cassaba Melon 63119- Figs 63121- Genip 63125- Guava/Jackfruit, raw 6312650 Kiwi 6312651 Lychee, raw 6312660 Lychee, cooked 63127- Honeydew 63129- Mango 63133- Papaya 63134- Passion Fruit 63141- Pineapple 63145- Pomegranate 63148- Sweetsop, Soursop, Tamarind 63149- Watermelon 64120- Papaya Juice 64121- Passion Fruit Juice 64124- Pineapple Juice 64133- Watermelon Juice 6420150 Banana Nectar



Appendix 13A

Appendix 13A. Food Codes and Definitions Used in Analysis of the 1987-88 USDA NFCS Data (continued)

Food Product	Household Code/Definition	Individual Code
Protected Fruits (continued)	5122916 Mangos with sugar, canned 5122917 Mangos without sugar, canned 5122918 Mangos, canned, baby 5122920 Guava with sugar, canned 5122921 Guava without sugar, canned 5122923 Papaya with sugar, canned 5122924 Papaya without sugar, canned 52232- Bananas, frozen 52235- Melon, frozen 52237- Pineapple, frozen 5331- Canned Citrus Juices 53323- Canned Pineapple Juice 5332408 Canned Papaya Juice 5332410 Canned Mango Juice 5332501 Canned Papaya Concentrate 5341- Frozen Citrus Juice 5342203 Frozen Pineapple Juice 5351- Citrus and Citrus Blend Juices, asep. packed 5352302 Pineapple Juice, asep. packed 5361- Fresh Citrus and Citrus Blend Juices 5362206 Papaya Juice, fresh 5362207 Pineapple-Coconut Juice, fresh 5362208 Mango Juice, fresh 5362209 Pineapple Juice, fresh 5423108 Pineapple, dry 5423109 Papaya, dry 5423110 Bananas, dry 5423111 Mangos, dry 5423117 Litchis, dry 5423118 Tamarind, dry 5423119 Plantain, dry (includes baby foods)	64202- Cantaloupe Nectar 64203- Guava Nectar 64204- Mango Nectar 64210- Papaya Nectar 64213- Passion Fruit Nectar 64221- Soursop Nectar 6710503 Bananas, baby 6711500 Bananas, baby, dry 6720500 Orange Juice, baby 6721300 Pineapple Juice, baby (includes baby foods/juices except mixtures; excludes fruit mixtures)



Appendix 13A. Food Codes and Definitions Used in Analysis of the 1987-88 USDA NFCS Data (continued)

Food Product	Household Code/Definition	Individual Code
Exposed Veg.	491- Fresh Dark Green Vegetables 493- Fresh Tomatoes 4941- Fresh Asparagus 4943- Fresh Beans, Snap or Wax 4944- Fresh Cabbage 4945- Fresh Lettuce 4946- Fresh Okra 49481- Fresh Artichokes 49483- Fresh Brussel Sprouts 4951- Fresh Celery 4952- Fresh Cucumbers 4955- Fresh Cauliflower 4958103 Fresh Kohlrabi 4958111 Fresh Jerusalem Artichokes 4958112 Fresh Mushrooms 4958113 Mushrooms, home canned 4958114 Mushrooms, home frozen 4958118 Fresh Eggplant 4958119 Eggplant, cooked 4958120 Eggplant, home frozen 4958200 Fresh Summer Squash 4958201 Summer Squash, cooked 4958202 Summer Squash, home canned 4958203 Summer Squash, home frozen 4958402 Fresh Bean Sprouts 4958403 Fresh Alfalfa Sprouts 4958504 Bamboo Shoots 4958506 Seaweed 4958508 Tree Fern, fresh 4958601 Sauerkraut 5111- Dark Green Vegetables (all are exposed) 5113- Tomatoes 5114101 Asparagus, comm. canned 51144- Beans, green, snap, yellow, comm. canned 5114704 Snow Peas, comm. canned 5114801 Sauerkraut, comm. canned 5114901 Artichokes, comm. canned 5114902 Bamboo Shoots, comm. canned 5114903 Bean Sprouts, comm. canned 5114904 Cabbage, comm. canned 5114905 Cabbage, comm. canned, no sauce 5114906 Cauliflower, comm. canned, no sauce 5114907 Eggplant, comm. canned, no sauce 5114913 Mushrooms, comm. canned 5114914 Okra, comm. canned 5114918 Seaweeds, comm. canned 5114920 Summer Squash, comm. canned	721- Dark Green Leafy Veg. 722- Dark Green Nonleafy Veg. 74- Tomatoes and Tomato Mixtures 7510050 Alfalfa Sprouts 7510075 Artichoke, Jerusalem, raw 7510080 Asparagus, raw 75101- Beans, sprouts and green, raw 7510275 Brussel Sprouts, raw 7510280 Buckwheat Sprouts, raw 7510300 Cabbage, raw 7510400 Cabbage, Chinese, raw 7510500 Cabbage, Red, raw 7510700 Cauliflower, raw 7510900 Celery, raw 7510950 Chives, raw 7511100 Cucumber, raw 7511120 Eggplant, raw 7511200 Kohlrabi, raw 75113- Lettuce, raw 7511500 Mushrooms, raw 7511900 Parsley 7512100 Pepper, hot chili 75122- Peppers, raw 7512750 Seaweed, raw 7512775 Snowpeas, raw 75128- Summer Squash, raw 7513210 Celery Juice 7514100 Cabbage or cole slaw 7514130 Chinese Cabbage Salad 7514150 Celery with cheese 75142- Cucumber salads 75143- Lettuce salads 7514410 Lettuce, wilted with bacon dressing 7514600 Greek salad 7514700 Spinach salad 7520600 Algae, dried 75201- Artichoke, cooked 75202- Asparagus, cooked 75203- Bamboo shoots, cooked 752049- Beans, string, cooked 75205- Beans, green, cooked/canned 75206- Beans, yellow, cooked/canned 75207- Bean Sprouts, cooked 752085- Breadfruit 752090- Brussel Sprouts, cooked 75210- Cabbage, Chinese, cooked 75211- Cabbage, green, cooked



Appendix 13A

Appendix 13A. Food Codes and Definitions Used in Analysis of the 1987-88 USDA NFCS Data (continued)

Food Product	Household Code/Definition	Individual Code
Exposed Veg. (cont.)	5114923 Chinese or Celery Cabbage, comm. canned 51152- Tomatoes, canned, low sod. 5115301 Asparagus, canned, low sod. 5115302 Beans, Green, canned, low sod. 5115303 Beans, Yellow, canned, low sod. 5115309 Mushrooms, canned, low sod. 51154- Greens, canned, low sod. 5115501 Sauerkraut, low sodium 5211- Dark Gr. Veg., comm. frozen (all exp.) 52131- Asparagus, comm. froz. 52133- Beans, snap, green, yellow, comm. froz. 5213407 Peapods, comm froz. 5213408 Peapods, with sauce, comm froz. 5213409 Peapods, with other veg., comm froz. 5213701 Brussel Sprouts, comm. froz. 5213702 Brussel Sprouts, comm. froz. with cheese 5213703 Brussel Sprouts, comm. froz. with other veg. 5213705 Cauliflower, comm. froz. 5213706 Cauliflower, comm. froz. with sauce 5213707 Cauliflower, comm. froz. with other veg. 5213708 Caul., comm. froz. with other veg. & sauce 5213709 Summer Squash, comm. froz. 5213710 Summer Squash, comm. froz. with other veg. 5213716 Eggplant, comm. froz. 5213718 Mushrooms with sauce, comm. froz. 5213719 Mushrooms, comm. froz. 5213720 Okra, comm. froz. 5213721 Okra, comm. froz., with sauce 5311- Canned Tomato Juice and Tomato Mixtures 5312102 Canned Sauerkraut Juice 5321- Frozen Tomato Juice 5371- Fresh Tomato Juice 5381102 Aseptically Packed Tomato Juice 5413101 Dry Algae 5413102 Dry Celery 5413103 Dry Chives 5413109 Dry Mushrooms 5413111 Dry Parsley 5413112 Dry Green Peppers 5413113 Dry Red Peppers 5413114 Dry Seaweed 5413115 Dry Tomatoes (does not include soups, sauces, gravies, mixtures, and ready-to-eat dinners; includes baby foods except mixtures)	75212- Cabbage, red, cooked 752130- Cabbage, savoy, cooked 75214- Cauliflower 75215- Celery, Chives, Christophine (chayote) 752167- Cucumber, cooked 752170- Eggplant, cooked 752171- Fern shoots 752172- Fern shoots 752173- Flowers of sesbania, squash or lily 7521801 Kohlrabi, cooked 75219- Mushrooms, cooked 75220- Okra/lettuce, cooked 7522116 Palm Hearts, cooked 7522121 Parsley, cooked 75226- Peppers, pimento, cooked 75230- Sauerkraut, cooked/canned 75231- Snowpeas, cooked 75232- Seaweed 75233- Summer Squash 7540050 Artichokes, stuffed 7540101 Asparagus, creamed or with cheese 75403- Beans, green with sauce 75404- Beans, yellow with sauce 7540601 Brussel Sprouts, creamed 7540701 Cabbage, creamed 75409- Cauliflower, creamed 75410- Celery/Chiles, creamed 75412- Eggplant, fried, with sauce, etc. 75413- Kohlrabi, creamed 75414- Mushrooms, Okra, fried, stuffed, creamed 754180- Squash, baked, fried, creamed, etc. 7541822 Christophine, creamed 7550011 Beans, pickled 7550051 Celery, pickled 7550201 Cauliflower, pickled 755025- Cabbage, pickled 7550301 Cucumber pickles, dill 7550302 Cucumber pickles, relish 7550303 Cucumber pickles, sour 7550304 Cucumber pickles, sweet 7550305 Cucumber pickles, fresh 7550307 Cucumber, Kim Chee 7550308 Eggplant, pickled 7550311 Cucumber pickles, dill, reduced salt 7550314 Cucumber pickles, sweet, reduced salt 7550500 Mushrooms, pickled 7550700 Okra, pickled 75510- Olives 7551101 Peppers, hot 7551102 Peppers, pickled 7551301 Seaweed, pickled 7553500 Zucchini, pickled 76102- Dark Green Veg., baby 76401- Beans, baby (excl. most soups & mixtures)



Appendix 13A. Food Codes and Definitions Used in Analysis of the 1987-88 USDA NFCS Data (continued)

Food Product	Household Code/Definition	Individual Code
Protected Veg.	4922- Fresh Pumpkin, Winter Squash 4942- Fresh Lima Beans 4947- Fresh Peas 49482- Fresh Soy Beans 4956- Fresh Corn 4958303 Succotash, home canned 4958304 Succotash, home frozen 4958401 Fresh Cactus (prickly pear) 4958503 Burdock 4958505 Bitter Melon 4958507 Horseradish Tree Pods 51122- Comm. Canned Pumpkin and Squash (baby) 51142- Beans, comm. canned 51143- Beans, lima and soy, comm. canned 51146- Corn, comm. canned 5114701 Peas, green, comm. canned 5114702 Peas, baby, comm. canned 5114703 Peas, blackeye, comm. canned 5114705 Pigeon Peas, comm. canned 5114919 Succotash, comm. canned 5115304 Lima Beans, canned, low sod. 5115306 Corn, canned, low sod. 5115307 Creamed Corn, canned, low sod. 511531- Peas and Beans, canned, low sod. 52122- Winter Squash, comm. froz. 52132- Lima Beans, comm. froz. 5213401 Peas, gr., comm. froz. 5213402 Peas, gr., with sauce, comm. froz. 5213403 Peas, gr., with other veg., comm. froz. 5213404 Peas, gr., with other veg., comm. froz. 5213405 Peas, blackeye, comm. froz. 5213406 Peas, blackeye, with sauce, comm. froz. 52135- Corn, comm. froz. 5213712 Artichoke Hearts, comm. froz. 5213713 Baked Beans, comm. froz. 5213717 Kidney Beans, comm. froz. 5213724 Succotash, comm. froz. 5411- Dried Beans 5412- Dried Peas and Lentils 5413104 Dry Corn 5413106 Dry Hominy 5413504 Dry Squash, baby 5413603 Dry Creamed Corn, baby (does not include soups, sauces, gravies, mixtures, and ready-to-eat dinners; includes baby foods except mixtures)	732- Pumpkin 733- Winter Squash 7510200 Lima Beans, raw 7510550 Cactus, raw 7510960 Corn, raw 7512000 Peas, raw 7520070 Aloe vera juice 752040- Lima Beans, cooked 752041- Lima Beans, canned 7520829 Bitter Melon 752083- Bitter Melon, cooked 7520950 Burdock 752131- Cactus 752160- Corn, cooked 752161- Corn, yellow, cooked 752162- Corn, white, cooked 752163- Corn, canned 7521749 Hominy 752175- Hominy 75223- Peas, cowpeas, field or blackeye, cooked 75224- Peas, green, cooked 75225- Peas, pigeon, cooked 75301- Succotash 75402- Lima Beans with sauce 75411- Corn, scalloped, fritter, with cream 7541650 Pea salad 7541660 Pea salad with cheese 75417- Peas, with sauce or creamed 7550101 Corn relish 76205- Squash, yellow, baby 76405- Corn, baby 76409- Peas, baby 76411- Peas, creamed, baby (does not include vegetable soups; vegetable mixtures; or vegetable with meat mixtures)



Appendix 13A

Appendix 13A. Food Codes and Definitions Used in Analysis of the 1987-88 USDA NFCS Data (continued)

Food Product	Household Code/Definition	Individual Code
Root Vegetables	48- Potatoes, Sweetpotatoes 4921- Fresh Carrots 4953- Fresh Onions, Garlic 4954- Fresh Beets 4957- Fresh Turnips 4958101 Fresh Celeriac 4958102 Fresh Horseradish 4958104 Fresh Radishes, no greens 4958105 Radishes, home canned 4958106 Radishes, home frozen 4958107 Fresh Radishes, with greens 4958108 Fresh Salsify 4958109 Fresh Rutabagas 4958110 Rutabagas, home frozen 4958115 Fresh Parsnips 4958116 Parsnips, home canned 4958117 Parsnips, home frozen 4958502 Fresh Lotus Root 4958509 Ginger Root 4958510 Jicama, including yambean 51121- Carrots, comm. canned 51145- Beets, comm. canned 5114908 Garlic Pulp, comm. canned 5114910 Horseradish, comm. prep. 5114915 Onions, comm. canned 5114916 Rutabagas, comm. canned 5114917 Salsify, comm. canned 5114921 Turnips, comm. canned 5114922 Water Chestnuts, comm. canned 51151- Carrots, canned, low sod. 5115305 Beets, canned, low sod. 5115502 Turnips, low sod. 52121- Carrots, comm. froz. 5213714 Beets, comm. froz. 5213722 Onions, comm. froz. 5213723 Onions, comm. froz., with sauce 5213725 Turnips, comm. froz. 5312103 Canned Carrot Juice 5312104 Canned Beet Juice 5372102 Fresh Carrot Juice 5413105 Dry Garlic 5413110 Dry Onion 5413502 Dry Carrots, baby 5413503 Dry Sweet Potatoes, baby (does not include soups, sauces, gravies, mixtures, and ready-to-eat dinners; includes baby foods except mixtures)	71- White Potatoes and Puerto Rican St. Veg. 7310- Carrots 7311140 Carrots in sauce 7311200 Carrot chips 734- Sweetpotatoes 7510250 Beets, raw 7511150 Garlic, raw 7511180 Jicama (yambean), raw 7511250 Leeks, raw 751117- Onions, raw 7512500 Radish, raw 7512700 Rutabaga, raw 7512900 Turnip, raw 752080- Beets, cooked 752081- Beets, canned 7521362 Cassava 7521740 Garlic, cooked 7521771 Horseradish 7521850 Lotus root 752210- Onions, cooked 7522110 Onions, dehydrated 752220- Parsnips, cooked 75227- Radishes, cooked 75228- Rutabaga, cooked 75229- Salsify, cooked 75234- Turnip, cooked 75235- Water Chestnut 7540501 Beets, harvard 75415- Onions, creamed, fried 7541601 Parsnips, creamed 7541810 Turnips, creamed 7550021 Beets, pickled 7550309 Horseradish 7551201 Radishes, pickled 7553403 Turnip, pickled 76201- Carrots, baby 76209- Sweetpotatoes, baby 76403- Beets, baby (does not include vegetable soups; vegetable mixtures; or vegetable with meat mixtures)



Appendix 13A. Food Codes and Definitions Used in Analysis of the 1987-88 USDA NFCS Data (continued)

Food Product	Household Code/Definition	Individual Code
<b>USDA SUBCATEGORIES</b>		
Dark Green Vegetables	491- Fresh Dark Green Vegetables 5111- Comm. Canned Dark Green Veg. 51154- Low Sodium Dark Green Veg. 5211- Comm. Frozen Dark Green Veg. 5413111 Dry Parsley 5413112 Dry Green Peppers 5413113 Dry Red Peppers (does not include soups, sauces, gravies, mixtures, and ready-to-eat dinners; includes baby foods except mixtures/dinners; excludes vegetable juices and dried vegetables)	72- Dark Green Vegetables all forms leafy, nonleafy, dk. gr. veg. soups
Deep Yellow Vegetables	492- Fresh Deep Yellow Vegetables 5112- Comm. Canned Deep Yellow Veg. 51151- Low Sodium Carrots 5212- Comm. Frozen Deep Yellow Veg. 5312103 Carrot Juice 54135- Dry Carrots, Squash, Sw. Potatoes (does not include soups, sauces, gravies, mixtures, and ready-to-eat dinners; includes baby foods except mixtures/dinners; excludes vegetable juices and dried vegetables)	73- Deep Yellow Vegetables all forms carrots, pumpkin, squash, sweetpotatoes, dp. yell. veg. soups
Other Vegetables	494- Fresh Light Green Vegetables 495- Fresh Other Vegetables 5114- Comm. Canned Other Veg. 51153- Low Sodium Other Veg. 51155- Low Sodium Other Veg. 5213- Comm. Frozen Other Veg. 5312102 Sauerkraut Juice 5312104 Beet Juice 5411- Dried Beans 5412- Dried Peas, Lentils 541310- Dried Other Veg. 5413114 Dry Seaweed 5413603 Dry Cr. Corn, baby (does not include soups, sauces, gravies, mixtures, and ready-to-eat dinners; includes baby foods except mixtures/dinners; excludes vegetable juices and dried vegetables)	75- Other Vegetables all forms
Citrus Fruits	501- Fresh Citrus Fruits 5121- Comm. Canned Citrus Fruits 5331- Canned Citrus and Citrus Blend Juice 5341- Frozen Citrus and Citrus Blend Juice 5351- Aseptically Packed Citrus and Citr. Blend Juice 5361- Fresh Citrus and Citrus Blend Juice (includes baby foods; excludes dried fruits)	61- Citrus Fruits and Juices 6720500 Orange Juice, baby food 6720600 Orange-Apricot Juice, baby food 6720700 Orange-Pineapple Juice, baby food 6721100 Orange-Apple-Banana Juice, baby food (excludes dried fruits)



*Appendix 13A*

Appendix 13A. Food Codes and Definitions Used in Analysis of the 1987-88 USDA NFCS Data (continued)

Food Product	Household Code/Definition	Individual Code
Other Fruits	502- Fresh Other Vitamin C-Rich Fruits 503- Fresh Other Fruits 5122- Comm. Canned Fruits Other than Citrus 5222- Frozen Strawberries 5223- Frozen Other than Citr. or Vitamin C-Rich Fr. 5332- Canned Fruit Juice Other than Citrus 5342- Frozen Juices Other than Citrus 5352- Aseptically Packed Fruit Juice Other than Citr. 5362- Fresh Fruit Juice Other than Citrus 542- Dry Fruits (includes baby foods; excludes dried fruits)	62- Dried Fruits 63- Other Fruits 64- Fruit Juices and Nectars Excluding Citrus 671- Fruits, baby 67202- Apple Juice, baby 67203- Baby Juices 67204- Baby Juices 67212- Baby Juices 67213- Baby Juices 673- Baby Fruits 674- Baby Fruits



## TABLE OF CONTENTS

	<u>Page No.</u>
14. BREAST MILK INTAKE .....	1
14.1. BACKGROUND .....	1
14.2. KEY STUDIES ON BREAST MILK INTAKE .....	1
14.3. RELEVANT STUDIES ON BREAST MILK INTAKE .....	4
14.4. KEY STUDIES ON LIPID CONTENT AND FAT INTAKE FROM BREAST MILK .....	5
14.5. OTHER FACTORS .....	6
14.6. RECOMMENDATIONS .....	7
14.7 REFERENCES FOR CHAPTER 14 .....	8

## LIST OF TABLES

Table 14-1. Daily Intakes of Breast Milk . . . . .	2
Table 14-2. Breast Milk Intake for Infants Aged 1 to 6 Months . . . . .	2
Table 14-3. Breast Milk Intake Among Exclusively Breast-fed Infants During the First 4 Months of Life . . . . .	3
Table 14-4. Breast Milk Intake During a 24-Hour Period . . . . .	3
Table 14-5. Breast Milk Intake Estimated by the DARLING Study . . . . .	4
Table 14-6. Milk Intake for Bottle- and Breast-fed Infants by Age Group . . . . .	4
Table 14-7. Milk Intake for Boys and Girls . . . . .	4
Table 14-8. Intake of Breast Milk and Formula . . . . .	5
Table 14-9. Lipid Content of Human Milk and Estimated Lipid Intake Among Exclusively Breast-fed Infants . . . . .	6
Table 14-10. Predicted Lipid Intakes for Breast-fed Infants Under 12 Months of Age . . . . .	6
Table 14-11. Number of Meals Per Day . . . . .	7
Table 14-12. Percentage of Mothers Breast-feeding Newborn Infants in the Hospital and Infants at 5 or 6 Months of Age in the United States in 1989 <sup>a</sup> , by Ethnic Background and Selected Demographic Variables <sup>b</sup> . . . . .	10
Table 14-13. Breast Milk Intake Studies . . . . .	11
Table 14-14. Confidence in Breast Milk Intake Recommendations . . . . .	13
Table 14-15. Breast Milk Intake Rates Derived From Key Studies . . . . .	14
Table 14-16. Summary of Recommended Breast Milk and Lipid Intake Rates . . . . .	15

**14. BREAST MILK INTAKE****14.1. BACKGROUND**

Breast milk is a potential source of exposure to toxic substances for nursing infants. Lipid soluble chemical compounds accumulate in body fat and may be transferred to breast-fed infants in the lipid portion of breast milk. Because nursing infants obtain most (if not all) of their dietary intake from breast milk, they are especially vulnerable to exposures to these compounds. Estimating the magnitude of the potential dose to infants from breast milk requires information on the quantity of breast milk consumed per day and the duration (months) over which breast-feeding occurs. Information on the fat content of breast milk is also needed for estimating dose from breast milk residue concentrations that have been indexed to lipid content.

Several studies have generated data on breast milk intake. Typically, breast milk intake has been measured over a 24-hour period by weighing the infant before and after each feeding without changing its clothing (test weighing). The sum of the difference between the measured weights over the 24-hour period is assumed to be equivalent to the amount of breast milk consumed daily. Intakes measured using this procedure are often corrected for evaporative water losses (insensible water losses) between infant weighings (NAS, 1991). Neville et al. (1988) evaluated the validity of the test weight approach among bottle-fed infants by comparing the weights of milk taken from bottles with the differences between the infants' weights before and after feeding. When test weight data were corrected for insensible water loss, they were not significantly different from bottle weights. Conversions between weight and volume of breast milk consumed are made using the density of human milk (approximately 1.03 g/mL) (NAS, 1991). Recently, techniques for measuring breast milk intake using stable isotopes have been developed. However, few data based on this new technique have been published (NAS, 1991).

Studies among nursing mothers in industrialized countries have shown that intakes among infants average approximately 750 to 800 g/day (728 to 777 mL/day) during the first 4 to 5 months of life with a range of 450 to 1,200 g/day (437 to 1,165 mL/day) (NAS, 1991). Similar intakes have also been reported for developing countries (NAS, 1991). Infant birth weight and nursing frequency have been shown to influence the rate of intake (NAS, 1991). Infants who are larger at birth and/or nurse more frequently have been shown to have higher intake rates. Also, breast milk production among nursing mothers has

been reported to be somewhat higher than the amount actually consumed by the infant (NAS, 1991).

The available studies on breast milk intake are summarized in the following sections. Studies on breast milk intake rates have been classified as either key studies or relevant studies based on the criteria described in the Introduction (Volume I, Section 1.3.1). Recommended intake rates are based on the results of key studies, but relevant studies are also presented to provide the reader with added perspective on the current state of knowledge pertaining to breast milk intake.

Relevant data on lipid content and fat intake, breast-feeding duration and frequency, and the estimated percentage of the U.S. population that breast-feeds are also presented.

**14.2. KEY STUDIES ON BREAST MILK INTAKE**

*Pao et al. (1980) - Milk Intakes and Feeding Patterns of Breast-fed Infants* - Pao et al. (1980) conducted a study of 22 healthy breast-fed infants to estimate breast milk intake rates. Infants were categorized as completely breast-fed or partially breast-fed. Breast feeding mothers were recruited through LaLeche League groups. Except for one black infant, all other infants were from white middle-class families in southwestern Ohio. The goal of the study was to enroll infants as close to one month of age as possible and to obtain records near one, three, six, and nine months of age (Pao et al., 1980). However, not all mother/infant pairs participated at each time interval. Data were collected for these 22 infants using the test weighing method. Records were collected for three consecutive 24-hour periods at each test interval. The weight of breast milk was converted to volume by assuming a density of 1.03 g/mL. Daily intake rates were calculated for each infant based on the mean of the three 24-hour periods. Mean daily breast milk intake rates for the infants surveyed at each time interval are presented in Table 14-1. For completely breast-fed infants, the mean intake rates were 600 mL/day at 1 month of age and 833 mL/day at 3 months of age. Partially breast-fed infants had mean intake rates of 485 mL/day, 467 mL/day, 395 mL/day, and 554 mL/day at 1, 3, 6, and 9 months of age, respectively. Pao et al. (1980) also noted that intake rates for boys in both groups were slightly higher than for girls.



Table 14-1. Daily Intakes of Breast Milk

Age	Number of Infants Surveyed at Each Time Period	Mean Intake (mL/day) <sup>a</sup>	Range of Daily Intake (mL/day)
Completely Breast-fed			
1 month	11	600 ± 159	426 - 989
3 months	2	833	645 - 1,000
6 months	1	682	616 - 786
Partially Breast-fed			
1 month	4	485 ± 79	398 - 655
3 months	11	467 ± 100	242 - 698
6 months	6	395 ± 175	147 - 684
9 months	3	<554	451 - 732

<sup>a</sup> Data expressed as mean ± standard deviation.  
Source: Pao et al., 1980.

The advantage of this study is that data for both exclusively and partially breast-fed infants were collected for multiple time periods. Also, data for individual infants were collected over 3 consecutive days which would account for some individual variability. However, the number of infants in the study was relatively small and may not be entirely representative of the U.S. population, based on race and socioeconomic status, which may introduce some bias in the results. In addition, this study did not account for insensible water loss which may underestimate the amount of breast milk ingested.

*Dewey and Lönnerdal (1983) - Milk and Nutrient Intakes of Breast-fed Infants from 1 to 6 Months* - Dewey and Lönnerdal (1983) monitored the dietary intake of 20 breast-fed infants between the ages of 1 and 6 months. Most of the infants in the study were exclusively breast-fed (five were given some formula, and several were given small amounts of solid foods after 3 months of age). According to Dewey and Lönnerdal (1983), the mothers were all well educated and recruited through Lamaze childbirth classes in the Davis area of California. Breast milk intake volume was estimated based on two 24-hour test weighings per month. Breast milk intake rates for the various age groups are presented in Table 14-2. Breast milk intake averaged 673, 782, and 896 mL/day at 1, 3, and 6 months of age, respectively.

The advantage of this study is that it evaluated breast-fed infants for a period of 6 months based on two 24-hour observations per infant per month. Corrections for insensible water loss apparently were not made. Also, the number of infants in the study was relatively small and may not be representative of U.S. population, based on race and socioeconomic status.

Table 14-2. Breast Milk Intake for Infants Aged 1 to 6 Months

Age (months)	Number of Infants	Mean (mL/day)	SD (mL/day) <sup>a</sup>	Range (mL/day)
1	16	673	192	341-1,003
2	19	756	170	449-1,055
3	16	782	172	492-1,053
4	13	810	142	593-1,045
5	11	805	117	554-1,045
6	11	896	122	675-1,096

<sup>a</sup> Standard deviation.  
Source: Dewey and Lönnerdal, 1983.

*Butte et al. (1984) - Human Milk Intake and Growth in Exclusively Breast-fed Infants* - Breast milk intake was studied in exclusively breast-fed infants during the first 4 months of life (Butte et al., 1984). Breastfeeding mothers were recruited through the Baylor Milk Bank Program in Texas. Forty-five mother/infant pairs participated in the study. However, data for some time periods (i.e., 1, 2, 3, or 4 months) were missing for some mothers as a result of illness or other factors. The mothers were from the middle- to upper-socioeconomic stratum and had a mean age of 28.0 ± 3.1 years. A total of 41 mothers were white, 2 were Hispanic, 1 was Asian, and 1 was West Indian. Infant growth progressed satisfactorily over the course of the study. The amount of milk ingested over a 24-hour period was determined using the test weighing procedure. Test weighing occurred over a 24-hour period for most participants, but intake among several infants was studied over longer periods (48 to 96 hours) to assess individual variation in intake. The study did not indicate whether the data were corrected for insensible water loss. Mean breast milk intake ranged from 723 g/day (702 mL/day) at 3 months to 751 g/day (729 mL/day) at 1 month, with an overall mean of 733 g/day (712 mL/day) for the entire study period (Table 14-3). Intakes were also calculated on the basis of body weight (Table 14-3). Based on the results of test weighings conducted over 48 to 96 hours, the mean variation in individual daily intake was estimated to be 7.9±3.6 percent.



Chapter 14 - Breast Milk Intake

Table 14-3. Breast Milk Intake Among Exclusively Breast-fed Infants During the First 4 Months of Life

Age (months)	Number of Infants	Breast Milk Intake <sup>a</sup> (g/day)	Breast Milk Intake <sup>a</sup> (g/kg-day)	Body Weight <sup>b</sup> (kg)
1	37	751.0 ± 130.0	159.0 ± 24.0	4.7
2	40	725.0 ± 131.0	129.0 ± 19.0	5.6
3	37	723.0 ± 114.0	117.0 ± 20.0	6.2
4	41	740.0 ± 128.0	111.0 ± 17.0	6.7

<sup>a</sup> Data expressed as mean ± standard deviation.  
<sup>b</sup> Calculated by dividing breast milk intake (g/day) by breast milk intake (g/kg-day).  
 Source: Butte et al., 1984.

The advantage of this study is that data for a larger number of exclusively breast-fed infants were collected than were collected by Pao et al. (1980). However, data were collected over a shorter time period (i.e., 4 months compared to 6 months) and day-to-day variability was not characterized for all infants. In addition, the population studied may not be representative of the U.S. population based on race and socioeconomic status.

Neville et al. (1988) - *Studies on Human Lactation* - Neville et al. (1988) studied breast milk intake among 13 infants during the first year of life. The mothers were all multiparous, nonsmoking, Caucasian women of middle- to upper-socioeconomic status living in Denver, Colorado (Neville et al., 1988). All women in the study practiced exclusive breast-feeding for at least 5 months. Solid foods were introduced at mean age of 7 months. Daily milk intake was estimated by the test weighing method with corrections for insensible weight loss. Data were collected daily from birth to 14 days, weekly from weeks 3 through 8, and monthly until the study period ended at 1 year after inception. The estimated breast milk intakes for this study are listed in Table 14-4. Mean breast milk intakes were 770 g/day (748 mL/day), 734 g/day (713 mL/day), 766 g/day (744 mL/day), and 403 g/day (391 mL/day) at 1, 3, 6, and 12 months of age, respectively.

In comparison to the previously described studies, Neville et al. (1988) collected data on numerous days over a relatively long time period (12 months) and they were corrected for insensible weight loss. However, the intake rates presented in Table 14-4 are estimated based on intake during only a 24-hour period. Consequently, these intake rates are based on short-term data that do not account for day-to-day variability among individual infants. Also, a smaller number of subjects was included than in the

previous studies, and the population studied may not be representative of the U.S. population, based on race and socioeconomic status.

Table 14-4. Breast Milk Intake During a 24-Hour Period

Age (days)	Number of Infants	Mean (g/day)	Standard Deviation (g/day)	Range (g/day)
1	7	44	71	-31-149 <sup>a</sup>
2	10	182	86	44-355
3	11	371	153	209-688
4	11	451	176	164-694
5	12	498	129	323-736
6	10	508	167	315-861
7	8	573	167	406-842
8	9	581	159	410-923
9	10	580	76	470-720
10	10	589	132	366-866
11	8	615	168	398-934
14	10	653	154	416-922
21	10	651	84	554-786
28	13	770	179	495-1144
35	12	668	117	465-930
42	12	711	111	554-896
49	10	709	115	559-922
56	13	694	98	556-859
90	12	734	114	613-942
120	13	711	100	570-847
150	13	838	134	688-1173
180	13	766	121	508-936
210	12	721	154	486-963
240	10	622	210	288-1002
270	12	618	220	223-871
300	11	551	234	129-894
330	9	554	240	120-860
360	9	403	250	65-770

<sup>a</sup> Negative value due to insensible water loss correction.  
 Source: Neville et al., 1988.

Dewey et al. (1991a; 1991b) - *The DARLING Study* - The Davis Area Research on Lactation, Infant Nutrition and Growth (DARLING) study was conducted in 1986 to evaluate growth patterns, nutrient intake, morbidity, and activity levels in infants who were breast-fed for at least the first 12 months of life (Dewey et al., 1991a; 1991b). Seventy-three infants aged 3 months were included in the study. The number of infants included in the study at subsequent time intervals was somewhat lower as a result of attrition. All infants in the study were healthy and of normal gestational age and weight at birth, and did not consume solid foods until after the first 4 months of age. The mothers were highly educated and of "relatively high socioeconomic status" from the Davis area of California (Dewey et al., 1991a; 1991b). Breast milk intake was



estimated by weighing the infants before and after each feeding and correcting for insensible water loss. Test weighings were conducted over a 4-day period every 3 months. The results of the study indicate that breast milk intake declines over the first 12 months of life. Mean breast milk intake was estimated to be 812 g/day (788 mL/day) at 3 months and 448 g/day (435 mL/day) at 12 months (Table 14-5). Based on the estimated intakes at 3 months of age, variability between individuals (coefficient of variation (CV) = 16.3 percent) was higher than individual day-to-day variability (CV = 5.4 percent) for the infants in the study (Dewey et al., 1991a).

Age (months)	Number of Infants	Mean Intake (g/day)	Standard Deviation (g/day)
3	73	812	133
6	60	769	171
9	50	646	217
12	42	448	251

Source: Dewey et al. (1991b).

The advantages of this study are that data were collected over a relatively long-time (4 days) period at each test interval which would account for some day-to-day infant variability, and corrections for insensible water loss were made. However, the population studied may not be representative of the U.S. population, based on race and socioeconomic status.

### 14.3. RELEVANT STUDIES ON BREAST MILK INTAKE

*Hofvander et al. (1982) - The Amount of Milk Consumed by 1- to 3-Month Old Breast- or Bottle-Fed Infants* - Hofvander et al. (1982) compared milk intake among breast-fed and bottle-fed infants at ages 1, 2, and 3 months of age. Intake of breast milk and breast milk substitutes was tabulated for 25 Swedish infants in each age group. Daily intake among breast-fed infants was estimated using the test weighing method. Test weighings were conducted over a 24-hour time period at each time interval. Daily milk intake among bottle-fed infants was estimated by measuring the volumetric differences in milk contained in bottles at the beginning and end of all feeding sessions in a 24-hour period. The mean intake rates for bottle-fed infants were slightly higher than for breast-fed infants for all age groups (Table 14-6). Also, boys consumed breast milk or breast milk substitutes at a slightly higher rate than girls

(Table 14-7). Breast milk intake was estimated to be 656 g/day (637 mL/day) at 1 month and 776 g/day (753 mL/day) at 3 months.

Age (months)	Breast Milk Substitutes Mean (g/day) <sup>a</sup>	Breast Milk Mean (g/day) <sup>a</sup>
1	713 (500-1,000)	656 (360-860)
2	811 (670-1,180)	773 (575-985)
3	853 (655-1,065)	776 (600-930)

<sup>a</sup> Range given in parentheses.  
Source: Hofvander et al., 1982.

Age	Boys		Girls	
	Mean (g/day)	N	Mean (g/day)	N
<b>Breast milk</b>				
1	663	12	649	13
2	791	14	750	11
3	811	12	743	13
<b>Breast milk substitute</b>				
1	753	10	687	15
2	863	13	753	12
3	862	13	843	12

Source: Hofvander et al., 1982.

This study was conducted among a small number of Swedish infants, but the results are similar to those summarized previously for U.S. studies. Insensible water losses were apparently not considered in this study, and only short-term data were collected.

*Köhler et al. (1984) - Food Intake and Growth of Infants Between Six and Twenty-six Weeks of Age on Breast Milk, Cow's Milk, Formula, and Soy Formula* - Köhler et al. (1984) evaluated breast milk and formula intake among normal infants between the ages of 6 and 26 weeks. The study included 25 fully breast-fed and 34 formula-fed infants from suburban communities in Sweden. Intake among breast-fed infants was estimated using the test weighing method over a 48-hour test period. Intake among formula-fed infants was estimated by feeding infants from



Chapter 14 - Breast Milk Intake

bottles with known volumes of formula and recording the amount consumed over a 48-hour period. Table 14-8 presents the mean breast milk and formula intake rates for the infants studied. Data were collected for both cow's milk-based formula and soy-based formula. The results indicated that the daily intake for bottle-fed infants was greater than for breast-fed infants.

The advantages of this study are that it compares breast milk intake to formula intake and that test weightings were conducted over 2 consecutive days to account for variability

the length of time that an infant nurses. Lipid content increases from the beginning to the end of a single nursing session (NAS, 1991). The lipid portion accounts for approximately 4 percent of human breast milk ( $39 \pm 4.0$  g/L) (NAS, 1991). This value is supported by various studies that evaluated lipid content from human breast milk. Several studies also estimated the quantity of lipid consumed by breast-feeding infants. These values are appropriate for performing exposure assessments for nursing infants when the contaminant(s) have residue

Table 14-8. Intake of Breast Milk and Formula

Age (wks)	Breast Milk			Cow's Formula			Soy Formula		
	N	Mean (g/day)	SD (g/day)	N	Mean (g/day)	SD (g/day)	N	Mean (g/day)	SD (g/day)
6	26	746	101	20	823	111	13	792	127
14	21	726	143	19	921	95	13	942	78
22	13	722	114	18	818	201	13	861	196
26	12	689	120	18	722	209	12	776	159

Source: Köhler et al., 1984.

in individual intake. Although the population studied was not representative of the U.S. population, similar intake rates were observed in the studies that were previously summarized.

*Axelsson et al. (1987) - Protein and Energy Intake During Weaning* - Axelsson et al. (1987) measured food consumption and energy intake in 30 healthy Swedish infants between the ages of 4 and 6 months. Both formula-fed and breast-fed infants were studied. All infants were fed supplemental foods (i.e., pureed fruits and vegetables after 4 months, and pureed meats and fish after 5 months). Milk intake among breast-fed infants was estimated by weighing the infants before and after each feeding over a 2-day period at each sampling interval. Breast milk intake averaged 765 mL/day at 4.5 months of age, and 715 mL/day at 5.5 months of age.

This study is based on short-term data, a small number of infants, and may not be representative of the U.S. population. However, the intake rates estimated by this study are similar to those generated by the U.S. studies that were summarized previously.

**14.4. KEY STUDIES ON LIPID CONTENT AND FAT INTAKE FROM BREAST MILK**

Human milk contains over 200 constituents including lipids, various proteins, carbohydrates, vitamins, minerals, and trace elements as well as enzymes and hormones (NAS, 1991). The lipid content of breast milk varies according to

concentrations that are indexed to the fat portion of human breast milk.

*Butte et al. (1984) - Human Milk Intake and Growth in Exclusively Breast-fed Infants* - Butte et al., (1984) analyzed the lipid content of breast milk samples taken from women who participated in a study of breast milk intake among exclusively breast-fed infants. The study was conducted with over 40 women during a 4-month period. The mean lipid content of breast milk at various infants' ages is presented in Table 14-9. The overall lipid content for the 4-month study period was  $34.3 \pm 6.9$  mg/g (3.4 percent). Butte et al. (1984) also calculated lipid intakes from 24-hour breast milk intakes and the lipid content of the human milk samples. Lipid intake was estimated to range from 23.6 g/day (3.8 g/kg-day) to 28.0 g/day (5.9 g/kg-day).

The number of women included in this study was small, and these women were selected primarily from middle- to upper-socioeconomic classes. Thus, data on breast milk lipid content from this study may not be entirely representative of breast milk lipid content among



Table 14-9. Lipid Content of Human Milk and Estimated Lipid Intake  
Among Exclusively Breast-fed Infants

Age (months)	Number of Observations	Lipid Content (mg/g) <sup>a</sup>	Lipid Content (percent) <sup>b</sup>	Lipid Intake (g/day) <sup>a</sup>	Lipid Intake (g/kg-day) <sup>a</sup>
1	37	36.2 ± 7.5	3.6	28.0 ± 8.5	5.9 ± 1.7
2	40	34.4 ± 6.8	3.4	25.2 ± 7.1	4.4 ± 1.2
3	37	32.2 ± 7.8	3.2	23.6 ± 7.2	3.8 ± 1.2
4	41	34.8 ± 10.8	3.5	25.6 ± 8.6	3.8 ± 1.3

<sup>a</sup> Data expressed as means ± standard deviations.  
<sup>b</sup> Percents calculated from lipid content reported in mg/g.

Source: Butte, et al., 1984.

the U.S. population. Also, these estimates are based on short-term data and day-to-day variability was not characterized.

*Maxwell and Burmaster (1993) - A Simulation Model to Estimate a Distribution of Lipid Intake from Breast Milk Intake During the First Year of Life* - Maxwell and Burmaster (1993) used a hypothetical population of 5,000 infants between birth and 1 year of age to simulate a distribution of daily lipid intake from breast milk. The hypothetical population represented both bottle-fed and breast-fed infants aged 1 to 365 days. A distribution of daily lipid intake was developed based on data in Dewey et al. (1991b) on breast milk intake for infants at 3, 6, 9, and 12 months and breast milk lipid content, and survey data in Ryan et al. (1991) on the percentage of breast-fed infants under the age of 12 months (i.e., approximately 22 percent). A model was used to simulate intake among 1,113 of the 5,000 infants that were expected to be breast-fed. The results of the model indicated that lipid intake among nursing infants under 12 months of age can be characterized by a normal distribution with a mean of 26.8 g/day and a standard deviation of 7.4 g/day (Table 14-10). The model assumes that nursing infants are completely breast-fed and does not account for infants who are breast-fed longer than 1 year. Based on data collected by Dewey et al. (1991b), Maxwell and Burmaster (1993) estimated the lipid content of breast milk to be 36.7 g/L at 3 months (35.6 mg/g or 3.6%) and 40.2 g/L (39.0 mg/g or 3.9%) at 12 months.

The advantage of this study is that it provides a "snapshot" of daily lipid intake from breast milk for breast-fed infants. These results are, however, based on a simulation model and there are uncertainties associated with the assumptions made. The estimated mean lipid intake rate represents the average daily intake for nursing infants under 12 months of age. These data are useful for performing exposure assessments when the age of the infant cannot be

specified (i.e., 3 months or 6 months). Also, because intake rates are indexed to the lipid portion of the breast milk, they may be used in conjunction with residue concentrations indexed to fat content.

Table 14-10. Predicted Lipid Intakes for Breast-fed Infants Under 12 Months of Age

Statistic	Value
Number of Observations in Simulation	1,113
Minimum Lipid Intake	1.0 g/day
Maximum Lipid Intake	51.5 g/day
Arithmetic Mean Lipid Intake	26.8 g/day
Standard Deviation Lipid Intake	7.4 g/day

Source: Maxwell and Burmaster, 1993.

#### 14.5. OTHER FACTORS

Other factors associated with breast milk intake include: the frequency of breast-feeding sessions per day, the duration of breast-feeding per event, the duration of breast-feeding during childhood, and the magnitude and nature of the population that breast-feeds.

*Frequency and Duration of Feeding* - Hofvander et al. (1982) reported on the frequency of feeding among 25 bottle-fed and 25 breast-fed infants at ages 1, 2, and 3 months. The mean number of meals for these age groups was approximately 5 meals/day (Table 14-11). Neville et al. (1988) reported slightly higher mean feeding frequencies. The mean number of meals per day for exclusively breast-fed infants was 7.3 at ages 2 to 5 months and 8.2 at ages 2 weeks to 1 month. Neville et al. (1988) reported that, for infants between the ages of 1 week and 5 months, the average duration of a breast feeding session is 16-18 minutes.





Age (months)	Bottle-fed Infants (meals/day) <sup>a</sup>	Breast-fed (meals/day) <sup>a</sup>
1	5.4 (4-7)	5.8 (5-7)
2	4.8 (4-6)	5.3 (5-7)
3	4.7 (3-6)	5.1 (4-8)

<sup>a</sup> Data expressed as mean with range in parentheses.  
Source: Hofvander et al., 1982.

*Population of Nursing Infants and Duration of Breast-Feeding During Infancy* - According to NAS (1991), the percentage of breast-feeding women has changed dramatically over the years. Between 1936 and 1940, approximately 77 percent of infants were breast fed, but the incidence of breast-feeding fell to approximately 22 percent in 1972. The duration of breast-feeding also dropped from about 4 months in the early 1930s to 2 months in the late 1950s. After 1972, the incidence of breast-feeding began to rise again, reaching its peak at approximately 61 percent in 1982. The duration of breast-feeding also increased between 1972 and 1982. Approximately 10 percent of the mothers who initiated breast-feeding continued for at least 3 months in 1972; however, in 1984, 37 percent continued breast-feeding beyond 3 months. In 1989, breast-feeding was initiated among 52.2 percent of newborn infants, and 40 percent continued for 3 months or longer (NAS, 1991). Based on the data for 1989, only about 20 percent of infants were still breast fed by age 5 to 6 months (NAS, 1991). Data on the actual length of time that infants continue to breast-feed beyond 5 or 6 months are limited (NAS, 1991). However, Maxwell and Burmaster (1993) estimated that approximately 22 percent of infants under 1 year of age are breast-fed. This estimate is based on a reanalysis of survey data in Ryan et al. (1991) collected by Ross Laboratories (Maxwell and Burmaster, 1993). Studies have also indicated that breast-feeding practices may differ among ethnic and socioeconomic groups and among regions of the United States. The percentages of mothers who breast feed, based on ethnic background and demographic variables, are presented in Table 14-12 (NAS, 1991).

*Intake Rates Based on Nutritional Status* - Information on differences in the quality and quantity of breast milk consumed based on ethnic or socioeconomic characteristics of the population is limited. Lönnerdal et al. (1976) studied breast milk volume and composition (nitrogen, lactose,

proteins) among underprivileged and privileged Ethiopian mothers. No significant differences were observed between the data for these two groups; and similar data for well-nourished Swedish mothers were observed. Lönnerdal et al. (1976) stated that these results indicate that breast milk quality and quantity are not affected by maternal malnutrition. However, Brown et al. (1986a; 1986b) noted that the lactational capacity and energy concentration of marginally-nourished women in Bangladesh were "modestly less than in better nourished mothers." Breast milk intake rates for infants of marginally-nourished women in this study were 690±122 g/day at 3 months, 722±105 g/day at 6 months, and 719±119 g/day at 9 months of age (Brown et al., 1986a). Brown et al. (1986a) observed that breast milk from women with larger measurements of arm circumference and triceps skinfold thickness had higher concentrations of fat and energy than mothers with less body fat. Positive correlations between maternal weight and milk fat concentrations were also observed. These results suggest that milk composition may be affected by maternal nutritional status.

#### 14.6. RECOMMENDATIONS

The key studies described in this section were used in selecting recommended values for breast milk intake, fat content and fat intake, and other related factors. Although different survey designs, testing periods, and populations were utilized by the key and relevant studies to estimate intake, the mean and standard deviation estimates reported in these studies are relatively consistent. There are, however, limitations with the data. Data are not available for infants under 1 month of age. This subpopulation may be of particular concern since a larger number of newborns are totally breast fed. In addition, with the exception of Butte (1984), data were not presented on a body weight basis. This is particularly important since intake rates may be higher on a body weight basis for younger infants. Also, the data used to derive the recommendations are over 10 years old and the sample size of the studies was small. Other subpopulations of concern such as mothers highly committed to breast feeding, sometimes for periods longer than 1 year, may not be captured by the studies presented in this chapter. Further research is needed to identify these subgroups and to get better estimates of breast milk intake rates. The general designs of both key and relevant studies and their limitations are summarized in Table 14-13. Table 14-14 presents the confidence rating for breast milk intake recommendations.



*Breast Milk Intake* - The breast milk intake rates for nursing infants that have been reported in the key studies described in this section are summarized in Table 14-15. Based on the combined results of these studies, 742 mL/day is recommended to represent an average breast milk intake rate, and 1,033 mL/day represents an upper-percentile intake rate (based on the middle range of the mean plus 2 standard deviations) for infants between the ages of 1 and 6 months of age. The average value is the mean of the average intakes at 1, 3, and 6 months from the key studies listed in Table 14-15. It is consistent with the average intake rate of 718 to 777 mL/day estimated by NAS (1991) for infants during the first 4 to 5 months of life. Intake among older infants is somewhat lower, averaging 413 mL/day for 12-month olds (Neville et al. 1988; Dewey et al. 1991a; 1991b). When a time weighted average is calculated for the 12-month period, average breast milk intake is approximately 688 mL/day, and upper-percentile intake is approximately 980 mL/day. Table 14-16 summarizes these recommended intake rates.

*Lipid Content and Lipid Intake* - Recommended lipid intake rates are based on data from Butte et al. (1984) and Maxwell and Burmaster (1993). Butte et al. (1984) estimated that average lipid intake ranges from  $23.6 \pm 7.2$  g/day ( $22.9 \pm 7.0$  mL/day) to  $28.0 \pm 8.5$  g/day ( $27.2 \pm 8.3$  mL/day) between 1 and 4 months of age. These intake rates are consistent with those observed by Burmaster and Maxwell (1993) for infants under 1 year of age [ $26.8 \pm 7.4$  g/day ( $26.0 \pm 7.2$  mL/day)]. Therefore, the recommended breast milk lipid intake rate for infants under 1 year of age is 26.0 mL/day and the upper-percentile value is 40.4 mL/day (based on the mean plus 2 standard deviations). The recommended value for breast milk fat content is 4.0 percent based on data from NAS (1991), Butte et al. (1984), and Maxwell and Burmaster (1993).

#### 14.7. REFERENCES FOR CHAPTER 14

- Axelsson, I.; Borulf, S.; Righard, L.; R  ih  , N. (1987) Protein and energy intake during weaning: effects and growth. *Acta Paediatr. Scand.* 76:321-327.
- Brown, K.H.; Akhtar, N.A.; Robertson, A.D.; Ahmed, M.G. (1986a) Lactational capacity of marginally nourished mothers: relationships between maternal nutritional status and quantity and proximate composition of milk. *Pediatrics.* 78: 909-919.
- Brown, K.H.; Robertson, A.D.; Akhtar, N.A. (1986b) Lactational capacity of marginally nourished mothers: infants' milk nutrient consumption and patterns of growth. *Pediatrics.* 78: 920-927.
- Butte, N.F.; Garza, C.; Smith, E.O.; Nichols, B.L. (1984) Human milk intake and growth in exclusively breast-fed infants. *Journal of Pediatrics.* 104:187-195.
- Dewey, K.G.; L  nnerdal, B. (1983) Milk and nutrient intake of breast-fed infants from 1 to 6 months:relation to growth and fatness. *Journal of Pediatric Gastroenterology and Nutrition.* 2:497-506.
- Dewey, K.G.; Heinig, J.; Nommsen, L.A.; L  nnerdal, B. (1991a) Maternal versus infant factors related to breast milk intake and residual volume: the DARLING study. *Pediatrics.* 87:829-837.
- Dewey, K.G.; Heinig, J.; Nommsen, L.; L  nnerdal, B. (1991b) Adequacy of energy intake among breast-fed infants in the DARLING study: relationships to growth, velocity, morbidity, and activity levels. *The Journal of Pediatrics.* 119:538-547.
- Hofvander, Y.; Hagman, U.; Hillervik, C.; Sjol  n, S. (1982) The amount of milk consumed by 1-3 months old breast- or bottle-fed infants. *Acta Paediatr. Scand.* 71:953-958.
- K  hler, L.; Meeuwisse, G.; Mortensson, W. (1984) Food intake and growth of infants between six and twenty-six weeks of age on breast milk, cow's milk formula, and soy formula. *Acta Paediatr. Scand.* 73:40-48.
- L  nnerdal, B.; Forsum, E.; Gebre-Medhim, M.; Hombraes, L. (1976) Breast milk composition in Ethiopian and Swedish mothers: lactose, nitrogen, and protein contents. *The American Journal of Clinical Nutrition.* 29:1134-1141.
- Maxwell, N.I.; Burmaster, D.E. (1993) A simulation model to estimate a distribution of lipid intake from breast milk during the first year of life. *Journal of Exposure Analysis and Environmental Epidemiology.* 3:383-406.
- National Academy of Sciences (NAS). (1991) Nutrition during lactation. Washington, DC. National Academy Press.
- Neville, M.C.; Keller, R.; Seacat, J.; Lutes, V.; Neifert, M.; et al. (1988) Studies in human lactation: milk volumes in lactating women during the onset of lactation and full lactation. *American Journal of Clinical Nutrition.* 48:1375-1386.
- Pao, E.M.; Hines, J.M.; Roche, A.F. (1980) Milk intakes and feeding patterns of breast-fed infants.



Journal of the American Dietetic Association.  
77:540-545.

Ryan, A.S.; Rush, D.; Krieger, F.W.; Lewandowski, G.E.  
(1991) Recent declines in breastfeeding in the  
United States, 1984-1989. Pediatrics. 88:719-727.



Table 14-12. Percentage of Mothers Breast-feeding Newborn Infants in the Hospital and Infants at 5 or 6 Months of Age in the United States in 1989<sup>a</sup>, by Ethnic Background and Selected Demographic Variables<sup>b</sup>

Category	Total		White		Black		Hispanic <sup>c</sup>	
	Newborns	5-6 Mo Infants	Newborns	5-6 Mo Infants	Newborns	5-6 Mo Infants	Newborns	5-6 Mo Infants
All mothers	52.2	19.6	58.5	22.7	23.0	7.0	48.4	15.0
Parity								
Primiparous	52.6	16.6	58.3	18.9	23.1	5.9	49.9	13.2
Multiparous	51.7	22.7	58.7	26.8	23.0	7.9	47.2	16.5
Marital status								
Married	59.8	24.0	61.9	25.3	35.8	12.3	55.3	18.8
Unmarried	30.8	7.7	40.3	9.8	17.2	4.6	37.5	8.6
Maternal age								
<20 yr	30.2	6.2	36.8	7.2	13.5	3.6	35.3	6.9
20-24 yr	45.2	12.7	50.8	14.5	19.4	4.7	46.9	12.6
25-29 yr	58.8	22.9	63.1	25.0	29.9	9.4	56.2	19.5
30-34 yr	65.5	31.4	70.1	34.8	35.4	13.6	57.6	23.4
≥35 yr	66.5	36.2	71.9	40.5	35.6	14.3	53.9	24.4
Maternal education								
No college	42.1	13.4	48.3	15.6	17.6	5.5	42.6	12.2
College <sup>d</sup>	70.7	31.1	74.7	34.1	41.1	12.2	66.5	23.4
Family income								
<\$7,000	28.8	7.9	36.7	9.4	14.5	4.3	35.3	10.3
\$7,000-\$14,999	44.0	13.5	49.0	15.2	23.5	7.3	47.2	13.0
\$15,000-\$24,999	54.7	20.4	57.7	22.3	31.7	8.7	52.6	16.5
≥\$25,000	66.3	27.6	67.8	28.7	42.8	14.5	65.4	23.0
Maternal employment								
Full time	50.8	10.2	54.8	10.8	30.6	6.9	50.4	9.5
Part time	59.4	23.0	63.8	25.5	26.0	6.6	59.4	17.7
Not employed	51.0	23.1	58.7	27.5	19.3	7.2	46.0	16.7
U.S. census region								
New England	52.2	20.3	53.2	21.4	35.6	5.0	47.6	14.9
Middle Atlantic	47.4	18.4	52.4	21.8	30.6	9.7	41.4	10.8
East North Central	47.6	18.1	53.2	20.7	21.0	7.2	46.2	12.6
West North Central	55.9	19.9	58.2	20.7	27.7	7.9	50.8	22.8
South Atlantic	43.8	14.8	53.8	18.7	19.6	5.7	48.0	13.8
East South Central	37.9	12.4	45.1	15.0	14.2	3.7	23.5	5.0
West South Central	46.0	14.7	56.2	18.4	14.5	3.8	39.2	11.4
Mountain	70.2	30.4	74.9	33.0	31.5	11.0	53.9	18.2
Pacific	70.3	28.7	76.7	33.4	43.9	15.0	58.5	19.7

<sup>a</sup> Mothers were surveyed when their infants were 6 months of age. They were asked to recall the method of feeding the infant when in the hospital, at age 1 week, at months 1 through 5, and on the day preceding completion of the survey. Numbers in the columns labeled "5-6 Mo Infants" are an average of the 5-month and previous day responses.

<sup>b</sup> Based on data from Ross Laboratories.

<sup>c</sup> Hispanic is not exclusive of white or black.

<sup>d</sup> College includes all women who reported completing at least 1 year of college.

Source: NAS, 1991.



Table 14-13. Breast Milk Intake Studies

Study	Number of Individuals	Type of Feeding	Sampling Time and Interval	Population Studied	Comments
<u>KEY STUDIES</u>					
Butte et al., 1984	45	Exclusively breast-fed for first 4 months	Most infants studied over 1 day only, at 1, 2, 3, 4 months some studied over 48 to 96 hours to study individual variability	Mid- to upper-socioeconomic stratum	Estimated breast milk intake; corrected for insensible water loss
Dewey et al., 1991a; 1991b	73	Breast-fed for 12 months; exclusively breast-fed for at least first 4 months	Test weighing over 4-day period every 3 months for 1 year	Highly educated, high-socioeconomic class from Davis area of California	Estimated breast milk intake; corrected for insensible water loss
Dewey and Lönnerdal, 1983	20	Most infants exclusively breast-fed	Two test weighings per month for 6 months	Mid to upper class from Davis area of California	Estimated breast milk intake; did not correct for insensible water loss
Neville et al., 1988	13	Exclusively breast-fed infants	Infants studied over 24-hour period at each sampling interval; numerous sampling intervals over first year of life	Nonsmoking Caucasian mothers; middle- to upper-socioeconomic status	Estimated breast milk intake and lipid intake; corrected for insensible water loss; estimated frequency and duration of feeding
Pao et al., 1980	22	Completely or partially breast-fed infants	Three consecutive days at 1, 3, 6, and 9 months	White middle class from southeastern Ohio	Estimated breast milk intake; did not correct for insensible water loss



Table 14-13. Breast Milk Intake Studies (continued)

Study	Number of Individuals	Type of Feeding	Sampling Time and Interval	Population Studied	Comments
<u>RELEVANT STUDIES</u>					
Axelsson et al., 1987	30	Breast-fed infants and infants fed formula with two different energy contents	Studied over 2-day periods at 4.5 and 5.5 months of age	Swedish infants	Measured intake rates; not corrected for insensible water loss
Brown et al., 1986a; 1986b	58, 60	Breast-fed infants	Studied over 3 days at each interval	Bangladeshi infants; marginally nourished mothers	Measured milk and nutrient intake based on nutritional status; not corrected for insensible water loss
Hofvander et al., 1982	50	25 breast-fed and 25 formula-fed infants	Studied 24-hour period at 1, 2, and 3 months	Swedish infants	Estimated breast milk and formula intake; no corrections for insensible water loss among breast-fed infants; estimated frequency of feeding
Köhler et al., 1984	59	25 fully breast-fed and 34 formula-fed infants	Studied over 48-hour periods at 6, 14, 22, and 26 weeks of age	Swedish infants	Estimated breast milk and formula intake based on nutritional status; no corrections for insensible water loss among breast-fed infants
Maxwell and Burmaster, 1993	1,113	Population of 1,113 breast-fed infants based on a hypothetical population of 5,000 breast-fed and bottle-fed infants	NA	NA	Simulated distribution of breast milk intake based on data from Dewey 1991a; estimated percent of breast-fed infants under 12 months of age
NAS, 1991	NA	Breast-fed infants	NA	NA	Summarizes current state-of-knowledge on breast milk volume, composition and breast-feeding populations



Table 14-14. Confidence in Breast Milk Intake Recommendations

Considerations	Rationale	Rating
<b>Study Elements</b>		
• Level of peer review	All key studies are from peer review literature.	High
• Accessibility	Papers are widely available from peer review journals.	High
• Reproducibility	Methodology used was clearly presented.	High
• Focus on factor of interest	The focus of the studies was on estimating breast milk intake.	High
• Data pertinent to U.S.	Subpopulations of the U.S. were the focus of all the key studies.	High
• Primary data	All the studies were based on primary data.	High
• Currency	Studies were conducted between 1980-1986. Although incidence of breast feeding may change with time, breast milk intake among breastfed infants may not.	Medium
• Adequacy of data collection period	Infants were not studied long enough to fully characterize day to day variability.	Medium
• Validity of approach	Methodology uses changes in body weight as a surrogate for total ingestion. This is the best methodology there is to estimate breast milk ingestion. Mothers were instructed in the use of infant scales to minimize measurement errors. Three out of the 5 studies corrected data for insensible water loss.	Medium
• Study size	The sample sizes used in the key studies were fairly small (range 13-73).	
• Representativeness of the population	Population is not representative of the U.S.; only mid-upper class, well nourished mothers were studied. Socioeconomic factors may affect the incidence of breastfeeding. Mother's nourishment may affect milk production.	Low
• Characterization of variability	Not very well characterized. Infants under 1 month not captured, mothers committed to breast feeding over 1 year not captured.	Low
• Lack of bias in study design (high rating is desirable)	Bias in the studies was not characterized. Three out of 5 studies corrected for insensible water loss. Not correcting for insensible water loss may underestimate intake. Mothers selected for the studies were volunteers; therefore response rate does not apply. Population studied may introduce some bias in the results (see above).	Low
• Measurement error	All mothers were well educated and trained in the use of the scale which helped minimize measurement error.	Medium
<b>Other Elements</b>		
• Number of studies	There are 5 key studies.	High
• Agreement between researchers	There is good agreement among researchers.	High
<b>Overall Rating</b>	Studies were well designed. Results were consistent. Sample size was fairly low and not representative of U.S. population or population of nursing mothers. Variability cannot be characterized due to limitations in data collection period.	Medium



Table 14-15. Breast Milk Intake Rates Derived From Key Studies

Mean (mL/day)	N	Upper Percentile (mL/day) (mean plus 2 standard deviations)	Reference
<i>Age: 1 Month</i>			
600	11	918	Pao et al., 1980
729	37	981	Butte et al., 1984
747	13	1,095	Neville et al., 1988
673	16	1,057	Dewey and Lönnerdal, 1983
weighted avg = 702		1,007 <sup>a</sup>	
<i>Age: 3 Months</i>			
833	2	---	Pao et al., 1980
702	37	923	Butte et al., 1984
712	12	934	Neville et al., 1988
782	16	1,126	Dewey and Lönnerdal, 1983
788	73	1,046	Dewey et al., 1991b
weighted avg = 759		1,025 <sup>a</sup>	
<i>Age: 6 Months</i>			
682	1	---	Pao et al., 1980
744	13	978	Neville et al., 1988
896	11	1,140	Dewey and Lönnerdal, 1983
747	60	1,079	Dewey et al., 1991b
weighted avg = 765		1,059 <sup>a</sup>	
<i>Age: 9 Months</i>			
600	12	1,027	Neville et al., 1988
627	50	1,049	Dewey et al., 1991b
avg = 622		1,038	
<i>Age: 12 Months</i>			
391	9	877	Neville et al., 1988
435	42	923	Dewey et al., 1991a; 1991b
weighted avg = 427		900	
<i>12-MONTH TIME WEIGHTED AVERAGE</i>			
688		Range 900-1,059 (middle of the range 980)	

<sup>a</sup> Middle of the range.





Table 14-16. Summary of Recommended Breast Milk and Lipid Intake Rates		
Age	Mean	Upper Percentile
<u>Breast Milk</u>		
1-6 Months	742 mL/day	1,033 mL/day
12 Month Average	688 mL/day	980 mL/day
<u>Lipids<sup>a</sup></u>		
<1 Year	26.0 mL/day	40.4 mL/day

<sup>a</sup> The recommended value for the lipid content of breastmilk is 4.0 percent.

# TABLE OF CONTENTS

	<u>Page No.</u>
15. ACTIVITY FACTORS .....	1
15.1. ACTIVITY PATTERNS .....	1
15.1.1. Key Activity Pattern Studies .....	1
15.1.2. Relevant Activity Pattern Studies .....	7
15.2. OCCUPATIONAL MOBILITY .....	11
15.2.1. Background .....	11
15.2.2. Key Occupational Mobility Studies .....	11
15.3. POPULATION MOBILITY .....	12
15.3.1. Background .....	12
15.3.2. Key Population Mobility Studies .....	13
15.3.3. Relevant Population Mobility Studies .....	15
15.4. RECOMMENDATIONS .....	15
15.4.1. Recommendations for Activity Patterns .....	15
15.4.2. Recommendations: Occupational Mobility .....	17
<b>15.4.3. Recommendations: Population Mobility</b> .....	<b>17</b>
<b>15.4.4. Summary of Recommended Activity Factors</b> .....	<b>18</b>
15.5. REFERENCES FOR CHAPTER 15 .....	18



## 15. ACTIVITY FACTORS

In calculating exposure, a person's average daily dose is determined from a combination of variables including the pollutant concentration, exposure duration, and frequency of exposure (Sexton and Ryan, 1987). These variables can be dependent on human activity patterns and time spent at each activity and/or location. A person's total exposure can be predicted using indirect approaches such as computerized mathematical models. This indirect approach of predicting exposure also requires activity patterns (time use) data. Thus, individual or group activities are important determinants of potential exposure because toxic chemicals introduced into the environment may not cause harm to an individual until an activity is performed subjecting the individual to contact with those contaminants. An individual's choice on how to spend time will vary according to their occupation, hobbies, culture, location, gender, age, and personal preferences. Educational level attained and socioeconomic status also influence chosen activities and their duration.

The purpose of this section is to describe published time use studies that provide information on activities in which various individuals engage, length of time spent performing various activities, locations in which individuals spend time and length of time spent by individuals within those various microenvironments. According to Robinson and Thomas (1991), microenvironments refer to a combination of activities and locations that yield potential exposures. Information on time spent in specific occupations and residing in specific areas also is included in this section.

This section summarizes data on how much time individuals spend doing various activities and in various microenvironments. These data cover a wide scope of activities and populations. The following table (Table 15-1) should be used as a guide to locating the information relevant to activities and microenvironments of concern. Assessors can consider using these data to develop exposure duration estimates for specific exposure scenarios. Available studies are grouped as key or relevant studies. The classifications of these studies are based on the applicability of their data to exposure assessments. All tables that provide data from these studies are presented at the back of this chapter.

### 15.1. ACTIVITY PATTERNS

The purpose of this section is to describe published time use studies that provide information on time-activity

patterns of the national population and various sub-populations in the U.S. The studies involve survey designs where time diaries were used to collect information on the time spent at various activities and locations for children, adolescents, and adults, and to collect certain demographic and socioeconomic data. Available studies on time-activity data are summarized in the following sections. It should be noted that other site-limited studies, based on small sample sites, are available, but are not presented in this section. The studies presented in this section are ones believed to be the most appropriate for the purpose of the handbook. Activity pattern studies are presented in Sections 15.1.1 and 15.1.2.

#### 15.1.1. Key Activity Pattern Studies

*Timmer et al. (1985) - How Children Use Time* - Timmer et al. (1985) conducted a study using the data obtained on children's time use from a 1981-1982 Panel study. This study was a follow-up of households from a previous survey conducted in 1975-76. The 922 respondents in the 1981-82 study were those who had completed at least three out of four waves of interview in the 1975 - 1976 survey. Timmer et al. (1985) conducted the survey during February through December 1981, and households were contacted four times during a 3 month interval of the survey period. The first contact was a personal interview, followed by subsequent telephone interviews for most of the respondents. However, families with children were contacted personally and questionnaires were administered to a maximum of three children per household.

The children surveyed were between the ages of 3 and 17 years and were interviewed twice. The questionnaires administered to children had two components: a time diary and a standardized interview. The time diary involved children reporting their activities beginning at 12.00 a.m. the previous night; the duration and location of each activity; the presence of another individual; and whether they were performing other activities at the same time. The standardized interview administered to the children was to gather information about their psychological, intellectual (using reading comprehension tests), and emotional well-being; their hopes and goals; their family environment; and their attitudes and beliefs.

For preschool children, parents provided information about the child's previous day's activities. Children in first through third grades completed the time



diary with their parents assistance and, in addition, completed reading tests. Children in fourth grade and above provided their own diary information and participated in the interview. Parents were asked to assess their children's socioemotional and intellectual development. A survey form was sent to a teacher of each school-age child to evaluate each child's socioemotional and intellectual development. The activity descriptor codes used in this study were developed by Juster et al. (1983). The activity codes and descriptors used for the adult time diaries in both surveys are presented in Appendix Table 15A-1.

The mean time spent performing major activities on weekdays and weekends by age and sex, and type of day is presented in Table 15-2. On weekdays, children spend about 40 percent of their time sleeping, 20 percent in school, and 10 percent eating, washing, dressing, and performing other personal activities (Timmer et al., 1985). The data in Table 15-2 indicates that girls spend more time than boys performing household work and personal care activities, and less time playing sports. Also, children spend most of their free time watching television. Table 15-3 presents the mean time children spend during weekdays and weekends performing major activities by five different age groups. Also, the significant effects of each variable (i.e., age, sex) are shown in Table 15-3. Older children spend more time performing household and market work, studying and watching television, and less time eating, sleeping, and playing. Timmer et al. (1985) estimated that on the average, boys spend 19.4 hours a week watching television and girls spend 17.8 hours per week performing the same activity.

A limitation associated with this study is that the data do not provide overall annual estimates of children's time use since the data were collected only during the time of the year when children attend school and not during school vacation. Another limitation is that a distribution pattern of children's time use was not provided. In addition, the survey was conducted in 1981 so there is a potential that activity patterns in children may have changed significantly from that period to the present. Therefore, application of these data for current exposure situations may bias exposure assessments results. An advantage of this survey is that diary recordings of activity patterns were kept and the data obtained were not based completely on recall. Another advantage is that because parents assisted younger children with keeping their diaries and with interviews, any bias that may have been

created by having younger children record their data should have been minimized.

*James and Knuiman (1987) - An Application of Bayes Methodology to the Analysis of Diary Records from a Water Use Study* - In 1987, James and Knuiman provided a distribution of the amount of time (1-20 minutes) spent showering by individuals in households located in Australia. The distribution presented in the study of James and Knuiman was based on diary records of 2,500 households. James and Knuiman (1987) reported that 50 additional households provided data for shower durations exceeding 20 minutes, but were excluded from their analysis because specific values over 20 minutes were not reported. Using the data of James and Knuiman, a cumulative frequency distribution was derived for the handbook, based on the 2,550 households and is presented in Table 15-3. Based on the results in Table 15-3, approximate showering times are 7 minutes for the median value, 13 minutes for the 90th percentile, 16 minutes for the 95th percentile, and >20 minutes for the 99th percentile. The mean shower length is approximately 8 minutes using the shower durations of 1 to 20 minutes.

A mean value could not be calculated using the data for the 50 households that reported showering time >20 minutes. However, if a 30 minute showering time was assumed for the >20 minutes duration, the mean value would be 8.5 minutes as compared to a mean of 8 minutes if these households are excluded. Therefore, including the 50 additional households would give a similar mean and the results at the upper end of the distribution would not be affected.

A limitation of the study is that the data are from households in Australia and may not be representative of U.S. households. An advantage is that it presents cumulative distribution data.

*Robinson and Thomas (1991) - Time Spent in Activities, Locations, and Microenvironments: A California-National Comparison* - Robinson and Thomas (1991) reviewed and compared data from the 1987-88 California Air Resources Board (CARB) time activity study and from a similar 1985 national study, *American's Use of Time*. Data from the national study were recorded similarly to the CARB code categories, in order to make data comparisons (Robinson and Thomas, 1991).

The CARB study involved residents who lived in the state of California. One adult 18 years or older was randomly sampled in each household and was asked to complete a diary with entries for the previous day's



activities and the location of each activity. Time use patterns for other individuals 12 years and older in the households contacted were also included in the diaries. Telephone interviews based on the random-digit-dialing (RDD) procedure were conducted for approximately 1,762 respondents in the CARB survey. These interviews were distributed across all days of the week and across different months of the year (between October 1987-August 1988).

In the 1985 National study, single day diaries were collected from over 5,000 respondents across the U.S., 12 years of age and older. The study was conducted during January through December 1985. Three modes of time diary collection were employed for this survey: mailback, telephone interview, and personal interview. Data obtained from the personal interviews were not used in this study (Robinson and Thomas, 1991). The sample population for the mail-back and telephone interview was selected based on a RDD method. The RDD was designed to represent all telephone households in the contiguous United States (Robinson and Thomas, 1991). In addition to estimates of time spent at various activities and locations, the survey design provided information on the employment status, age, education, race, and gender for each member of the respondent's household. The mail-back procedure was based on a "tomorrow" approach, and the telephone interview was based on recall. In the "tomorrow" approach, respondents know, and agree ahead of time, that they will be keeping a diary (Robinson and Thomas, 1991).

Data comparisons by Robinson and Thomas (1991) were based on 10 major activity categories (100 sub-category codes) and 3 major locations (44 sub-location codes) employed in both the CARB and the 1985 national study. In order to make data comparisons, Robinson and Thomas (1991) excluded responses from individuals of ages 65 years and older and 18 years or younger in both surveys. In addition, only mail-back responses were analyzed for the 1985 national study. The data were then weighted to project both the California and national population in terms of days of the week, region, numbers of respondents per household, and 3 monthly seasons of the year (Robinson and Thomas, 1991).

Table 15-5 shows the mean time spent in the 10 major activities by gender and for all respondents between the ages of 18-64 years (time use data for the individual activities are presented in Appendix Table 15A-2). In both studies respondents spent most of their time (642 mins/day) on personal needs and care (i.e., sleep).

Californians spent more time on paid work, education and training, obtaining goods and services, and communication, and less time on household work, child care, organizational activities, entertainment/social activities, and recreation than the national population. The male and female population closely followed the same trends as the general population. Table 15-6 shows the mean time spent at 3 major locations for the CARB and national study grouped by total sample and gender, ages 18-64 years (time use data for the 44 detailed microenvironments are presented in Appendix Table 15A-3). Respondents spent most of their time at home, 892 minutes/day for the CARB and 954 minutes/day for the national study. Californians spent more of their time away from home and traveling compared to the national population.

In addition, Robinson and Thomas (1991) defined a set of 16 microenvironments based on the activity and location codes employed in both studies. The analysis included data for adolescents (12-17 years) and adults (65 years and older) in both the CARB study and the mail-back portion of the 1985 national study (Robinson and Thomas, 1991). The mean duration of time spent in locations for total sample population, 12 years and older, across three types of locations is presented in Table 15-7 for both studies. Respondents spent most of their time indoors, 1255 and 1279 minutes/day for the CARB and national study, respectively.

Table 15-8 presents the mean duration of time and standard mean error for the 16 microenvironments grouped by total sample population and gender. Also included is the mean time spent for respondents ("Doers") who reported participating in each activity. Table 15-8 shows that in both studies men spend more time in work locations, automobiles and other vehicles, autoplaces (garages), and physical outdoor activities, outdoor sites. In contrast, women spend more time cooking, engaging in other kitchen activities, performing other chores, and shopping. The same trends also occur on a per participant basis.

Table 15-9 shows the mean time spent in various microenvironments grouped by type of the day (weekday or weekend) in both studies. Generally, respondents spent most of their time during the weekends in restaurants/bars (CARB study), motor vehicles, outdoor activities, social-cultural settings, leisure/communication activities, and sleeping. Microenvironmental differences by age are presented in Table 15-10. Respondents in the age groups 18-24 years and 25-44 years spent most of their time in



restaurants/bars and traveling. The oldest age group, 65 years and older, spent most of their time in the kitchen (cooking and other kitchen related activities) and in communication activities.

Limitations associated with the Robinson and Thomas (1991) study are that the CARB survey was based on recall and the survey was performed in California only. Therefore, if applied to other populations, the data set may be biased. Another limitation is that time distribution patterns (statistical analysis) were not provided for both studies. Also, the data are based on short term studies. An advantage of this study is that the 1985 national study represents the general U.S. population. Also, the 1985 national study provides time estimates by activities, locations, and microenvironments grouped by age, gender, and type of day. Another advantage is that the data were compared and that, overall, both data sets showed similar patterns of activity (Robinson and Thomas, 1991).

*Wiley et al. (1991) - Study of Children's Activity Patterns* - The California children's activity pattern survey design provided time estimates of children (under 12 years old) in various activities and locations (microenvironments) on a typical day (Wiley et al., 1991). The sample population, which consisted of 1,200 respondents (including children under 12 years of age and adult informants residing in the child's household), was selected using Waksberg RDD methods from English-speaking households. One child was selected from each household. If the selected child was 8 years old or less, the adult in the same household who spent the most time with the child responded. However, if the selected child was between 9 and 11 years old, that child responded. The population was also stratified to provide representative estimates for major regions of the state. The survey questionnaire included a time diary which provided information on the children's activity and location patterns based on a 24-hour recall period. In addition, the survey questionnaire included questions about potential exposure to sources of indoor air pollution (i.e., presence of smokers) on the diary day and the socio-demographic characteristics (i.e., age, gender, marital status of adult) of children and adult respondents. The questionnaires and the time diaries were administered via a computer-assisted telephone interviewing (CATI) technology (Wiley et al., 1991). The telephone interviews were conducted during April 1989 to February 1990 over four seasons: Spring (April-June 1989), Summer (July-September 1989), Fall (October-December 1989), and Winter (January-February 1990).

The data obtained from the survey interviews resulted in ten major activity categories, 113 detailed activity codes, 6 major categories of locations, and 63 detailed location codes. The average time respondents spent during the 10 activity categories for all children are presented in Table 15-11. Also included in this table are the detailed activity, including its code, with the highest mean duration of time; the percentage of respondents who reported participating in any activity (percent doing); and the mean, median, and maximum time duration for "doers." The dominant activity category, personal care (night sleep being the highest contributor), had the highest time expenditure of 794 mins/day (13.2 hours/day). All respondents reported sleeping at night, resulting in a mean daily time per participant of 794 mins/day spent sleeping. The activity category "don't know" had a duration of about 2 mins/day and only 4 percent of the respondents reported missing activity time.

Table 15-12 presents the mean time spent in the 10 activity categories by age and gender. Differences in activity patterns for boys and girls tended to be small. Table 15-13 presents the mean time spent in the 10 activity categories grouped by seasons and California regions. There were seasonal differences for 5 activity categories: personal care, educational activities, social/entertainment, recreation, and communication/ passive leisure. Time expenditure differences in various regions of the State were minimal for childcare, work-related activities, shopping, personal care, education, social life, and recreation.

Table 15-14 presents the distribution of time across six location categories. The participation rates (percent) of respondents, the mean, median, and maximum time for "doers." The detailed location with the highest average time expenditure are also shown. The largest amount of time spent was at home (1,078 minutes/day); 99 percent of respondents spent time at home (1,086 minutes/participant/day). Tables 15-15 and 15-16 show the average time spent in the six locations grouped by age and gender, and season and region, respectively. There are age differences in time expenditure in educational settings for boys and girls (Table 15-15). There are no differences in time expenditure at the six locations by regions, and time spent in school decreased in the summer months compared to other seasons (Table 15-16). Table 15-17 shows the average potential exposure time children spent in proximity to tobacco smoke, gasoline fumes, and gas oven fumes grouped by age and gender. The sampled children spent more time closer to tobacco smoke (77



mins/day) than gasoline fumes (2 mins/day) and gas oven fumes (11 mins/day).

A limitation of this study is that the sampling population was restricted to only English-speaking households; therefore, the data obtained does not represent the diverse population group present in California. Another limitation is that time use values obtained from this survey were based on short-term recall (24-hr) data; therefore, the data set obtained may be biased. Other limitations are: the survey was conducted in California and is not representative of the national population, and the significance of the observed differences in the data obtained (i.e., gender, age, seasons, and regions) were not tested statistically. An advantage of this study is that time expenditure in various activities and locations were presented for children grouped by age, gender, and seasons. Also, potential exposures of respondents to pollutants were explored in the survey. Another advantage is the use of the CATI program in obtaining time diaries, which allows automatic coding of activities and locations onto a computer tape, and allows activities forgotten by respondents to be inserted into its appropriate position during interviewing (Wiley et al., 1991).

*U.S. EPA (1992) - Dermal Exposure Assessment: Principles and Applications* - U.S. EPA (1992) addressed the variables of exposure time, frequency, and duration needed to calculate dermal exposure as related to activity. The reader is referred to the document for a detailed discussion of these variables in relation to soil and water related activities. The suggested values that can be used for dermal exposure are presented in Table 15-18. Limitations of this study are that the values are based on small data sets and a limited number of studies. An advantage is that it presents default values for frequency and duration for use in exposure assessments when specific data are not available.

*Tsang and Klepeis (1996) - National Human Activity Pattern Survey (NHAPS)* - The National Human Activity Pattern Survey was conducted by the U.S. EPA (Tsang and Klepeis, 1996). It is the largest and most current human activity pattern survey available (Tsang and Klepeis, 1996). Data for 9,386 respondents in the 48 contiguous United States were collected via minute-by-minute 24-hour diaries between October 1992 and September 1994. Detailed data were collected for a maximum of 82 different possible locations, and a maximum of 91 different activities. Participants were selected using a Random Digit Dial (RDD) method and

Computer Assisted Telephone Interviewing (CATI). The response rate was 63 percent, overall. If the chosen respondent was a child too young to interview, an adult in the household gave a proxy interview. Each participant was asked to recount their entire daily routine from midnight to midnight immediately previous to the day that they were interviewed. The survey collected information on duration and frequency of selected activities and of the time spent in selected microenvironments. In addition, demographic information was collected for each respondent to allow for statistical summaries to be generated according to specific subgroups of the U.S. population (i.e., by gender, age, race, employment status, census region, season, etc.). The participants' responses were weighted according to geographic, socioeconomic, time/season, and other demographic factors to ensure that results were representative of the U.S. population. The weighted sample matches the 1990 U.S. census population for each gender, age group, census region, and the day-of-week and seasonal responses are equally distributed. Saturdays and Sundays were over sampled to ensure an adequate weekend sample.

The data presented are a compilation of 24-hour diary locations, activities, and follow-up exposure questions based on exposure-related events (personal, exposure, household characteristics, medical background) (Tsang and Klepeis, 1996). Data presented are reported in the form of means, percentages of time spent, and percentages of respondent occurrences. The diary data are useful for obtaining national representative distributions of time spent in a large variety of activities and locations in a single day (Tsang and Klepeis, 1996). According to Tsang and Klepeis (1996), the 24-hour diaries in the NHAPS are useful in probabilistic modeling (Monte-Carlo) that provides frequency distributions of exposure. Overall survey results indicate that for time spent in microenvironments, the largest overall percentage of time was spent in residential-indoors (67 percent), followed by time spent outdoors (8 percent), and then time spent in vehicles (5 percent) (Tsang and Klepeis, 1996). Tables 15-19 through 15-146 provide data from the NHAPS study. NHAPS data on the time spent in selected activities are presented in Tables 15-19 through 15-92. NHAPS data on the time spent in selected microenvironments are presented in Tables 15-93 to 15-139 and of these tables, Tables 15-66 through 15-139 present 24-hour cumulative statistics (mean, minimum, maximum, and percentiles) data for time spent in various activities and in various microenvironments.



- Tables 15-19 through 15-32 provide information on the frequency and duration of taking baths, frequency of taking showers, and on the amount of time spent in the shower or bathroom after completion of the activity.
- Table 15-33 provides the frequency for washing the hands in a day.
- Tables 15-34 through 15-36 present information on time spent by persons working with or being near foods while being grilled or barbecued; working with or near open flames; and working or being near excessive dust in the air.
- Tables 15-37 through 15-39 provide data for the number of times a vehicle was started in a garage or carport and if started with the door closed; and for time spent at a gas station or repair shop.
- Tables 15-40 through 15-42 present information on the number of times windows and doors were opened and the number of minutes they were left open at home while the respondent was at home.
- Tables 15-43 through 15-47 provide data for time spent in heavy traffic either running, walking, standing, or in a vehicle; and for time spent in indoor and outdoor parking lots and garages.
- Tables 15-48 through 15-50 present information for time spent working for pay; working at different times of day; and for the amount of that time was spent working outdoors.
- Tables 15-51 through 15-56 provide information for number of times of performing household tasks in a day such as vacuuming, and washing dishes and clothes in a residence.
- Tables 15-57 through 15-64 present data for number of times per day and the duration for playing in sand, gravel, and dirt; and for working in circumstances where one comes in contact with soil such as in a garden.
- Tables 15-65 through 15-67 provide information on the frequency of swimming in a fresh water swimming pool and the amount of time spent swimming during a 1-month period.
- Tables 15-68 through 15-87 present statistics for time spent in various major categories. They are as follows: Paid Work (main job); Household Work (food preparation and cleanup, cleaning house, clothes care); Child Care (indoor and outdoor playing); Obtaining Goods and Services (car repair); Personal Needs and Care (sleeping/napping); Free Time and Education (school); and Recreation (active sports, exercise, outdoor recreation).
- Tables 15-88 through 15-94 provide statistics for time spent in various activities that are the results of regrouping/combining activities described in Tables 15-68 through 15-87. Because the occurrences in some major categories were too small to conduct analyses, these categories were regrouped into broader categories so that new categories could be developed with a larger number of occurrences (Tsang and Klepeis, 1996). This regrouping was performed to create a better data set for estimating exposure activities from the available data (Tsang and Klepeis, 1996).
- Tables 15-95 through 15-103 provide cumulative statistics for time spent in various indoor microenvironments such as repair shops/gas stations; bar/ night club/bowling alley; and at school.
- Tables 15-104 through 15-112 present statistical data for time spent in various outdoor locations. These tables include data for locations such as schoolgrounds/ playground; parking lots; construction sites; parks and golf courses; and farms.





- Tables 15-113 through 15-120 present statistics for time spent in various locations in the home. Data are presented for the number of minutes spent in the kitchen, bathroom, bedroom, garage, basement, utility room or laundry room; in the outdoor pool or spa; and in the yard or other areas outside the house.
- Tables 15-121 through 15-130 provide data on time spent traveling and for traveling in various types of vehicles; and for time spent walking.
- Tables 15-131 through 15-140 provide statistics for total time spent indoors at home (categories regrouped/combined based on various data described in Tables 15-95 through 15-130), including all rooms; outdoors at home; traveling inside a vehicle; outdoors near a vehicle; outdoors other than near a residence; in an office or factory; in malls and other stores; in various public buildings; in bars, restaurants, etc.; and outdoor locations such as auto repair shops and laundromats.
- Table 15-141 provides the number of minutes spent in an activity or microenvironment where a smoker was present.
- Tables 15-142 and 15-143 present data for time spent smoking in a day.
- Tables 15-144 through 15-148 provide information for time spent smoking selected tobacco products such as cigars, cigarettes, and pipe tobacco.

Advantages of the NHAPS dataset are that it is representative of the U.S. population and it has been adjusted to be balanced geographically, seasonally, and for day/time. Also, it is representative of all ages, gender, and is race specific. A disadvantage of the study is that means cannot be calculated for time spent over 60, 120, and 181 minutes in selected activities. Therefore, actual time spent at the high end of the distribution for these activities cannot be captured.

### **15.1.2. Relevant Activity Pattern Studies**

*Robinson - Changes in Americans' Use of Time: 1965-1975 (1977)* - Robinson (1977) compared time use data obtained from two national surveys that were conducted in 1965-1966 and in 1975. Each survey used the time-diary method to collect data. The 1965-66 survey excluded people in the following categories: (a) Non-Standard Metropolitan Statistical Area (non-SMSA) (designation of Census Bureau areas having no city with more than 50,000 population); (b) households where no adult members were in the labor force for at least 10 hours per week; (c) age 65 and over; and (d) farm-related occupations (Robinson, 1977). The 1,244 respondents in the 1965-66 study included either employed men and women or housewives (Robinson, 1977). The survey was conducted between November-December 1965 and March-April 1966. Respondents recorded their daily activities in time diaries by using the "tomorrow" approach. In this approach, diaries were kept on the day following the interviewer's initial contact. The interviewer then made a second call to the respondent to determine if the information in diaries were correct and to obtain additional data. Only one person per household was interviewed. The survey was designed to obtain information on time spent with family members, time spent at various locations during activities, and performing primary and secondary activities.

A similar study was conducted in 1975 from October through December. Unlike the 1965-1966 survey, the 1975 survey included rural areas, farmers, the unemployed, students, and retirees. Time diary data were collected using the "yesterday" approach. In this approach, interviewers made only one contact with respondents (greater than 1500) and the diaries were filled out based on a 24-hour recall (Robinson, 1977). Time diary data were also collected from the respondents' spouses.

In both surveys, the various activities were coded into 96 categories, and then were combined into five major categories. Free-time activities were grouped into 5 sub-categories (Appendix Table 15A-2). In order to compare data obtained from both surveys, Robinson (1977) excluded the same population groups in the 1975 survey that were excluded in the 1965-66 survey (i.e., farmers, rural residents).

Results obtained from the surveys were presented by gender, age, marital and employment status, race, and education. Robinson (1977) reported the data collected in hours/week; however, the method for converting daily



activities to hours/week were not presented. Table 15-149 shows the differences in time use by gender, employment, and marital status for five major activity categories and five subcategories for 1965 and 1975. Time spent on work related activities (i.e., work for pay and family care) was lower in 1975 than in 1965 for employed men and women. Table 15-149 also shows that there was an overall increase in free time activities for all the six groups. The difference in time use in 1965 and 1975 are presented by age, education, and race in Tables 15-150, 15-151, and 15-152, respectively. These tables include data for students and certain employed respondents that were excluded in Table 15-148 (Robinson, 1977). In 1975, the eldest group (ages 56-65 years) showed a decline in paid work, and an increase in family care, personal care and sleep (Table 15-150). Education level comparisons across the ten-year interval indicated that the less educated had a decrease in paid work and an increase in sleep and personal care; the most educated had an increase in work time and a decrease in other leisure (Table 15-151). For racial comparisons, Blacks spent less time at paid work than Whites across the ten-year interval (Table 15-152). Table 15-152 also shows that Blacks spent more time than Whites at free time activities in 1975.

A limitation of the study survey design is that time use data were gathered as social indicators. Therefore, the activity categories presented may not be relevant in exposure assessments. Another limitation is that statistical analysis of the data set was not provided. Additional limitations are that the time use data are old and the data may not reflect recent changes in time use. The 1965 and 1975 data sets excluded certain population groups and, therefore, may not be entirely representative of the U.S. population. Another limitation is that these are short-term studies and may not necessarily represent long-term activity patterns. An advantage of this study is that time use data were presented by age, gender, race, education level, and employment and marital status. Another advantage is that earlier investigations on the study method (24-hr recall) employed in the 1965 study revealed no systematic biases in reported activities (Robinson, 1977). Robinson (1977) also noted that the time-diary method provides a "zero-sum" measure (i.e., since there are only 24 daily hours or 168 weekly hours, if time on one activity increases then time on another activity must decrease).

*Juster et al. (1983) - 1975-1981 Time Use Longitudinal Panel Study* - The Time Allocation longitudinal study of the U.S. population began as part of a multinational project with the first survey conducted in 1965-66. A second national time use survey was conducted in 1975-1976 and another in 1981 (Juster et al. 1983). Juster et al. (1983) provided study descriptions of the second and third surveys. The surveys included a probability sample of the adult population (18 years and older) and children between the ages of 3 and 17 years in the United States. In both surveys, time use was measured from 24-hour recall diaries administered to respondents and their spouses. The 1975-1976 survey involved four waves of interview: wave 1, October-November 1975; wave 2, February 1976; wave 3, May-June 1976; wave 4, September 1976. The first wave was a personal interview and the other three waves were telephone interviews. The 1975-1976 survey sample consisted of 2,300 individuals, and of that sample, 1,519 respondents. Four recall diaries (one from each wave of interviews) were obtained from 947 respondents, with data on time use measures for two weekdays, one Saturday and one Sunday. The survey was designed to gather information for: employment status; earnings and other income; "consumption benefits for activities of respondents and their spouses;" health, friendships and associations of the respondents; stock technology available to the household, house repair, and maintenance activities of the family; division of labor in household work and related attitudes; physical characteristics of the respondents housing structure, net worth and housing values; job characteristics; and characteristics of mass media usage on a typical day (Juster et al., 1983).

The 1981 survey was a follow-up of respondents and spouses who had completed at least three waves of interview in the 1975-1976 survey. For the 1981 survey, 920 individuals were eligible. The survey design was similar to the 1975-1976 survey, however in this survey, the adult population was 25 years and older and consisted of 620 respondents. Four waves of interviews were conducted between February - March 1981 (wave 1), May - June 1981 (wave 2), September 1981 (wave 3), and November - December (wave 4). The 1981 survey included the respondents' children between the ages of 3 and 17 years. The survey design for children provided information on time use measures from two time diary reports: one school day and one non-school day. In addition, information for academic achievement measures,



school and family life measures, and ratings from the children's teachers were gathered during the survey.

Juster et al. (1983) did not report the time use data obtained for the 1975-1976 survey or the 1981 survey. These data are stored in four tape files and can be obtained from the Inter-university Consortium for Political and Social Research (ICPSR) in Michigan. The response rate for the first wave of interview (1975-76 survey) based on the original sample population was 66 percent, and response rates for the subsequent waves ranged from 42 percent (wave 4) to 50 percent (wave 2). In the 1981 survey, the response rate based on eligible respondents was 67 percent for the first interview, and ranged from 54 percent (wave 4) to 60 percent (wave 2) in the subsequent interviews (Juster et al., 1983). The 1975-1976 survey included 87 activities. In the 1981 survey, these 87 activities were broken down into smaller components, resulting in 223 activities (Juster et al., 1983). The activity codes and descriptors used for the adult time diaries in both surveys are presented in Appendix Table 15A-3.

A limitation of this study is that the surveys were not designed for exposure assessment purposes. Therefore, the time use data set may be biased. Another limitation is that time use data collected were based on a 24-hour diary recall. This may somewhat bias the data set obtained from this survey. An advantage associated with this survey is that it provides a database of information on various human activities. This information can be used to assess various exposure pathways and scenarios associated with these activities. Also, some of the data from these surveys were used in the studies conducted by Timmer et al. (1985) and Hill (1985). In addition, the activity descriptor codes developed in these studies were used by Timmer et al. (1985), Hill (1985), and Robinson and Thomas (1991). These studies are presented in Sections 15.1.1 and 15.1.2. Another advantage of this survey is that the data are based on a national survey and conducted over a one year period, resulting in a seasonally balanced survey and one representative of the U.S. population.

*Hill (1985) - Patterns of Time Use* - Hill (1985) investigated the total amount of time American adults spend in one year performing various activities and the variation in time use across three different dimensions: demographic characteristics, geographical location, and seasonal characteristics. In this study, time estimates were based on data collected from time diaries in four waves (1 per season) of a survey conducted in the fall of 1975

through the fall of 1976 for the 1975-1976 Time Allocation Study. The sampling periods included two weekdays, one Saturday and one Sunday. The 1975-1976 Time Allocation Study provided information on the amount of time spent performing primary activities. The information gathered were responses to the survey question "What were you doing?" The survey also provided information on secondary activities (i.e., respondents performing more than one activity at the same time). Hill (1985) analyzed time estimates for 10 broad categories of activities based on data collected from 87 activities. These estimates included seasonal variation in time use patterns and comparisons of time use patterns for different days of the week. The 10 major categories and ranges of activity codes are listed in Appendix Table 15A-4. Hill (1985) collected data on time use for the major activity patterns in four different age groups (18-24, 25-44, 45-64, and 65 years and older). However, the time use data were summarized in graphs rather than in tables.

Analysis of the 1975-76 survey data revealed very small regional differences in time use among the broad activity patterns (Hill, 1985). The weighted mean hours per week spent performing the 10 major activity categories presented by region are shown in Table 15-153. In all regions, adults spent more time on personal care (included night sleep). Adults in the North Central region of the country spent more time on market work activities than adults in other regions of the country. Adults in the South spent more time on leisure activities (passive and active combined) than adults elsewhere (Table 15-153). Table 15-154 presents the time spent per day, by the day of the week for the 10 major activity categories. Time spent on the 87 activities (components of the 10 major categories) are presented in Appendix Table 15A-5. Adult time use was dominated in descending order by personal care (including sleep), market work, passive leisure, and house work. Collectively, these activities represent about 80 percent of available time (Hill, 1985).

According to Hill (1985), sleep was the single most dominant activity averaging about 56.3 hours per week. Television watching (passive leisure) averaged about 21.8 hours per week, and housework activities averaged about 14.7 hours per week. Weekdays were predominantly market-work oriented. Weekends (Saturday and Sunday) were predominantly devoted to household tasks ("sleeping in," socializing, and active leisure) (Hill, 1985). Table 15-155 presents the mean time spent performing these 10 groups of activities during each wave of interview (fall, winter, spring, and summer). Adjustments



were made to the data to assure equal distributions of weekdays, Saturdays, and Sundays (Hill, 1985). The data indicates that the time periods adults spent performing market work, child care, shopping, organizational activities, and active leisure were fairly constant throughout the year (Hill, 1985). The mean hours spent per week in performing the 10 major activity patterns are presented by gender in Table 15-156 (time use patterns for all 87 activities are presented in Appendix Table 15A-6). Table 15-156 indicates that time use patterns determined by data collected for the mid-1970's survey show gender differences. Men spent more time on activities related to labor market work and education, and women spent more time on household work activities.

A limitation associated with this study is that the time data were obtained from an old survey conducted in the mid-1970s. Because of fairly rapid changes in American society, applying these data to current exposure assessments may result in some biases. Another limitation is that time use data were not presented for children. An advantage of this study is that time diaries were kept and data were not based on recall. The former approach may result in a more accurate data set. Another advantage of this study is that the survey is seasonally balanced since it was conducted throughout the year and the data are from a large survey sample.

*Sell (1989) - The Use of Children's Activity Patterns in the Development of a Strategy for Soil Sampling in West Central Phoenix* - In a report prepared for the Arizona Department of Environmental Quality, Sell (1989) investigated the activity patterns of preschool and school age children in the west central portion of Phoenix known as Maryvale. The survey was conducted in two parts: (1) most of the school age children were interviewed personally from May through June, 1989 in three schools; and (2) survey questionnaires were mailed to parents of preschool children.

In the first survey, 15 percent of the total school population (2,008) was sampled with 111 children in grades K-6 participating (response rate of 37 percent). The surveyed population was 53.2 percent male and 46.8 percent female. Of this population, 41 percent were Hispanics, 49.5 percent Anglos, 7.2 percent Blacks, and 1.7 percent Asians. The children interviewed were between the ages of 5 and 13 years. Within each school, the children in grades K-6 were stratified into two groups, primary (grades K-3) and intermediate (grades 4-6), and children were selected randomly from each group. Children in grades K-2 were either interviewed in school

or at home in the presence of a parent or an adult care-provider. In the course of the interview, children were asked to identify locations of activity areas, social areas (i.e., places they went with friends), favorite areas, and locations of forts or clubhouses. Aerial photographs were used to mark these areas.

The second survey involved only preschool children. Parents completed questionnaires which provided information on the amount of time their children spent outdoors, outdoor play locations, favorite places, digging areas, use of park or playgrounds, and swimming or wading locations. This survey was conducted between June-July 1989. One thousand (1,000) parents were sampled, but only 211 questionnaires were usable out of 886 questionnaires received resulting in a response rate for the preschool's survey of about 24 percent. The sample population consisted of children 1 month and up to preschool age. Of this population, 53 percent were Anglos, 18 percent Hispanics, 2 percent Blacks, and 3 percent Asians.

The survey design considered the kinds of activities children engaged in, but not the amount of time children spent in each activity. Therefore, Sell (1989) presented the data obtained from the survey in terms of percent of respondents who engaged in specific activities or locations. A summary of percent responses of the preschool and school-age children's activities at various locations in the Maryvale study areas are presented in Table 15-157. Also included in this table is a ranking of children's play locations based on other existing research works. Based on the survey data, Sell (1989) reported that the median time preschool children spent outdoors on weekdays was 1-2 hours, and on weekends the median time spent outdoors was 2-5 hours. Most of these children played outside in their own yards, and some played in other people's yards or parks and playgrounds (Sell, 1989).

Limitations associated with this study are that the survey design did not report the time spent in various activities or locations and the response rates obtained from the surveys were low and, therefore, may result in biased data. In addition, because the survey was conducted in Arizona, the surveyed population does not represent the children's population on a national basis. Advantages of this study are that it provides data on various activities children engage in and locations of these activities, and provides for time spent outdoors. This information is useful in determining exposure pathways to toxic pollutants for children.



*Tarshis (1981) - The Average American Book* - Tarshis (1981) compiled a book addressing the habits, tastes, lifestyles, and attitudes of the American people in which he reported data on time spent in personal grooming. The data presented are gathered from small surveys, the Newspaper Advertising Bureau, and magazines. Tarshis reported frequency and percentage data by gender and age for grooming activities such as showering and bathing as follows:

- 90 percent take some sort of a bath in an average 24-hour period;
- 5 percent average more than 1 shower or bath a day;
- 75 percent of men shower, 25 percent take baths;
- 50 percent of women take showers, 50 percent take baths;
- 65 percent of teenage girls 16-19 shower daily;
- 55 percent of teenage girls take at least one bath a week;
- 50 percent of women use an additive in their bath every time they bathe;
- People are more likely to shower than bathe if they are young and have higher income; and
- Showering is more popular than bathing in large cities.

Limitations of this study are that the data are compiled from other sources, and that the data are old; it is possible that these data may not reflect the current trends of the general population. An advantage of the study is that it presents frequency data that are useful in exposure assessment, especially concerning volatilization of chemicals from water.

*AIHC (1994) - Exposure Factors Sourcebook* - The activity factors data presented in the Sourcebook are similar to that in this handbook. The AIHC Sourcebook uses tenure data from the Bureau of Labor Statistics (1987), while this handbook uses more recent data (Carey, 1988) and provides general and specific recommendations for various age groups. Distributions were derived using data presented in U.S. EPA (1989) version of this handbook, the Bureau of Labor Statistics (1987), and various other references. Distribution data and/or recommendations are presented for time in one residence, residential occupancy, time spent indoors/outdoors, hours at home/away from home for adults and children, hours at work for adults, working tenure, and shower duration. For each distribution, the @Risk formula is provided for

direct use in the @Risk software (Palisade, 1992). The Sourcebook has been classified as a relevant rather than a key study because it is not the primary source for the data used to make recommendations. It is a relevant source of alternative information.

## **15.2. OCCUPATIONAL MOBILITY**

### **15.2.1. Background**

The amount of time spent in different types of occupations may affect the duration and/or magnitude of exposures to contaminants specific to those occupations. For example, an individual who spends an entire lifetime as a farmer may experience a longer duration of exposure to certain contaminants, especially pesticides, than individuals who have indoor occupations. Also, individual exposures to specific chemicals in the work place may be significantly reduced when individuals change jobs. Work place exposures among women may be of shorter duration than among men because women's careers may be interrupted by home and family responsibilities. The key studies presented in the following section provide occupational tenure for workers grouped by age, race, gender, and employment status.

### **15.2.2. Key Occupational Mobility Studies**

*Carey (1988) - Occupational Tenure in 1987: Many Workers Have Remained in Their Fields* - Carey (1988) presented median occupational and employer tenure for different age groups, gender, earnings, ethnicity, and educational attainment. Occupational tenure was defined as "the cumulative number of years a person worked in his or her current occupation, regardless of number of employers, interruptions in employment, or time spent in other occupations" (Carey, 1988). The information presented was obtained from supplemental data to the January 1987 Current Population Study, a U.S. Bureau of the Census publication. Carey (1988) did not present information on the survey design.

The median occupational tenure by age and gender, ethnicity, and employment status are presented in Tables 15-158, 15-159, and 15-160, respectively. The median occupational tenure of the working population (109.1 million people) 16 years of age and older in January of 1987, was 6.6 years (Table 15-158). Table 15-158 also shows that median occupational tenure increased from 1.9 years for workers 16-24 years old to 21.9 years for workers 70 years and older. The median occupational tenure for men 16 years and older was higher (7.9 years) than for women of the same age group (5.4 years). Table



15-159 indicates that whites had longer occupational tenure (6.7 years) than blacks (5.8 years), and Hispanics (4.5 years). Full-time workers had more occupational tenure than part-time workers 7.2 years and 3.1 years, respectively (Table 15-160).

Table 15-161 presents the median occupational tenure among major occupational groups. The median tenure ranged from 4.1 years for service workers to 10.4 years for people employed in farming, forestry, and fishing. In addition, median occupational tenure among detailed occupations ranged from 24.8 years for barbers to 1.5 years for food counter and fountain workers (Appendix Table 15A-7).

The strength of an individual's attachment to a specific occupation has been attributed to the individual's investment in education (Carey, 1988). Carey (1988) reported the median occupational tenure for the surveyed working population by age and educational level. Workers with 5 or more years of college had the highest median occupational tenure of 10.1 years. Workers that were 65 years and older with 5 or more years of college had the highest occupational tenure level of 33.8 years. The median occupational tenure was 10.6 years for self-employed workers and 6.2 years for wage and salary workers (Carey, 1988).

A limitation associated with this study is that the survey design employed in the data collection was not presented. Therefore, the validity and accuracy of the data set cannot be determined. Another limitation is that only median values were reported in the study. An advantage of this study is that occupational tenure (years spent in a specific occupation) was obtained for various age groups by gender, ethnicity, employment status, and educational level. Another advantage of this study is that the data were based on a survey population which appears to represent the general U.S. population.

*Carey (1990) - Occupational Tenure, Employer Tenure, and Occupational Mobility* - Carey (1990) conducted another study that was similar in scope to the study of Carey (1988). The January 1987 Current Population Study (CPS) was used. This study provided data on occupational mobility and employer tenure in addition to occupational tenure. Occupational tenure was defined in Carey (1988) as the "the cumulative number of years a person worked in his or her current occupation, regardless of number of employees, interruptions in employment, or time spent in other locations." Employer tenure was defined as "the length of time a worker has been with the same employer," while occupational

mobility was defined as "the number of workers who change from one occupation to another" (Carey, 1990). Occupational mobility was measured by asking individuals who were employed in both January 1986 and January 1987 if they were doing the same kind of work in each of these months (Carey, 1990). Carey (1990) further analyzed the occupational mobility data and obtained information on entry and exit rates for occupations. These rates were defined as "the percentage of persons employed in an occupation who had voluntarily entered it from another occupation" and an exit rate was defined as "the percentage of persons employed in an occupation who had voluntarily left for a new occupation" (Carey, 1990).

Table 15-162 shows the voluntary occupational mobility rates in January 1987 for workers 16 years and older. For all workers, the overall voluntary occupational mobility rate was 5.3 percent. These data also show that younger workers left occupations at a higher rate than older workers. Carey (1990) reported that 10 million of the 100.1 million individuals employed in January 1986 and in January 1987 had changed occupations during that period, resulting in an overall mobility rate of 9.9 percent. Executive, administrative, and managerial occupations had the highest entry rate of 5.3 percent, followed by administrative support (including clerical) at 4.9 percent. Sales had the highest exit rate of 5.3 percent and service had the second highest exit rate of 4.8 percent (Carey, 1990). In January 1987, the median employer tenure for all workers was 4.2 years. The median employee tenure was 12.4 years for those workers that were 65 years of age and older (Carey, 1990).

Because the study was conducted by Carey (1990) in a manner similar to that of the previous study (Carey, 1988), the same advantages and disadvantages associated with Carey (1988) also apply to this data set.

### **15.3. POPULATION MOBILITY**

#### **15.3.1. Background**

An assessment of population mobility can assist in determining the length of time a household is exposed in a particular location. For example, the duration of exposure to site-specific contamination, such as a polluted stream from which a family fishes or contaminated soil on which children play or vegetables are grown, will be directly related to the period of time residents live near the contaminated site.

Information regarding population mobility is compiled and published by the U.S. Bureau of the Census (BOC). Banks, insurance companies, credit card



companies, real estate and housing associations use residence history information. However, usually this information is confidential. Information compiled by the BOC provides information about population mobility; however, it is difficult to determine the average residence time of a homeowner or apartment dweller from this information. Census data provide representations of a cross-section of the population at specific points in time, but the surveys are not designed to follow individual families through time. The most current BOC information about annual geographical mobility and mobility by State is summarized in Appendix 15B. Figure 15-1 graphically displays the distribution of movers by type of move.

Available information was provided by the Oxford Development Corporation, the National Association of Realtors (NAR), and the BOC. According to Oxford Development Corporation, a property management firm, the typical residence time for an apartment dweller for their corporation has been estimated to range from 18 to 30 months (S. Cameron Hendricks, Sales Department, Oxford Development Corporation, Gaithersburg, MD, personal communication with P. Wood (Versar) August 10, 1992).

### **15.3.2. Key Population Mobility Studies**

*Israeli and Nelson (1992) - Distribution and Expected Time of Residence for U.S. Households* - In risk assessments, the average current residence time (time since moving into current residence) has often been used as a substitute for the average total residence time (time between moving into and out of a residence) (Israeli and Nelson, 1992). Israeli and Nelson (1992) have estimated distributions of expected time of residence for U.S. households. Distributions and averages for both current and total residence times were calculated for several housing categories using the 1985 and 1987 BOC housing survey data. The total residence time distribution was estimated from current residence time data by modeling the moving process (Israeli and Nelson, 1992). Israeli and Nelson (1992) estimated the average total residence time for a household to be approximately 4.6 years or 1/6 of the expected life span (see Table 15-163). The maximal total residence time that a given fraction of households will live in the same residence is presented in Table 15-164. For example, only 5 percent of the individuals in the "All Households" category will live in the same residence for 23 years and 95 percent will move in less than 23 years.

The authors note that the data presented are for the expected time a household will stay in the same residence. The data do not predict the expected residence time for each member of the household, which is generally expected to be smaller (Israeli and Nelson, 1992). These values are more realistic estimates for the individual total residence time, than the average time a household has been living at its current residence. The expected total residence time for a household is consistently less than the average current residence time. This is the result of greater weighting of short residence time when calculating the average total residence time than when calculating the average current residence time (Israeli and Nelson, 1992). When averaging total residence over a time interval, frequent movers may appear several times, but when averaging current residence times, each household appears only once (Israeli and Nelson, 1992). According to Israeli and Nelson (1992), the residence time distribution developed by the model is skewed and the median values are considerably less than the means (T), which are less than the average current residence times.

*U.S. Bureau of the Census (1993) - American Housing Survey for the United States in 1991* - This survey is a national sample of 55,000 interviews in which collected data were presented owners, renters, Black householders, and Hispanic householders. The data reflect the number of years a unit has been occupied and represent all occupied housing units that the residents' rented or owned at the time of the survey.

The results of the survey pertaining to residence time of owner/renter occupied units in the U.S. are presented in Table 15-165. Using the data in Table 15-165, the percentages of householders living in houses for specified time ranges were determined and are presented in Table 15-166. Based on the BOC data in Table 15-165, the 50th percentile and the 90th percentile values were calculated for the number of years lived in the householder's current house. These values were calculated by apportioning the total sample size (93,147 households) to the indicated percentile associated with the applicable range of years lived in the current home. Assuming an even distribution within the appropriate range, the 50th and 90th percentile values for years living in current home were determined to be 9.1 and 32.7 years, respectively. These were then rounded to 9 and 33 years. Based on the above data, the range of 9 to 33 years is assumed to best represent a central tendency estimate of length of residence and upper percentile estimate of residence time, respectively.

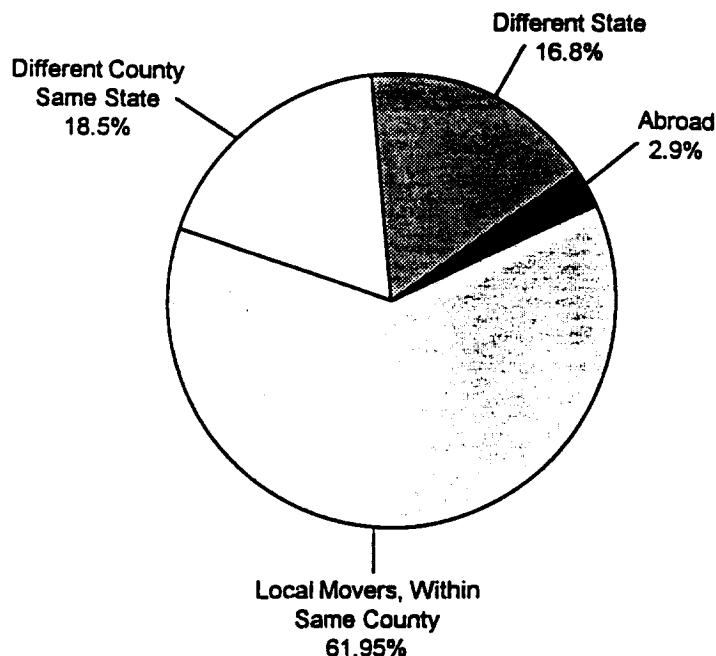

Figure 15-1. Distribution of Individuals Moving by Type of Move: 1991-92.

Source: U.S Bureau of the Census, 1993

A limitation associated with the above analysis is the assumption that there is an even distribution within the different ranges. As a result, the 50th and 90th percentile values may be biased.

*Johnson and Capel (1992) - A Monte Carlo Approach to Simulating Residential Occupancy Periods and Its Application to the General U.S. Population* - Johnson and Capel developed a methodology to estimate the distribution of the residential occupancy period (ROP) in the national population. ROP denotes the time (years) between a person moving into a residence and the time the person moves out or dies. The methodology used a Monte Carlo approach to simulate a distribution of ROP for 500,000 persons using data on population, mobility, and mortality.

The methodology consisted of six steps. The first step defined the population of interest and categorized them by location, gender, age, sex, and race. Next the demographic groups were selected and the fraction of the specified population that fell into each group was developed using U.S. BOC data. A mobility table was

developed based on census data, which provided the probability that a person with specified demographics did not move during the previous year. The fifth step used data on vital statistics published by the National Center for Health Statistics and developed a mortality table which provided the probability that individuals with specific demographic characteristics would die during the upcoming year. As a final step, a computer based algorithm was used to apply a Monte Carlo approach to a series of persons selected at random from the population being analyzed.

Table 15-167 presents the results for residential occupancy periods for the total population, by gender. The estimated mean ROP for the total population was 11.7 years. The distribution was skewed (Johnson and Capel, 1992): the 25th, 50th, and 75th percentiles were 4, 9, and 16 years, respectively. The 90th, 95th, and 99th percentiles were 26, 33, and 47 years, respectively. The mean ROP was 11.1 years for males and 12.3 years for females, and the median value was 8 years for males and 9 years for females.





Descriptive statistics for subgroups defined by current ages were also calculated. These data, presented by gender, are shown in Table 15-168. The mean ROP increases from age 3 to age 12 and there is a noticeable decrease at age 24. However, there is a steady increase from age 24 through age 81.

There are a few biases within this methodology that have been noted by the authors. The probability of not moving is estimated as a function only of gender and age. The Monte Carlo process assumes that this probability is independent of (1) the calendar year to which it is applied, and (2) the past history of the person being simulated. These assumptions, according to Johnson and Capel (1992), are not entirely correct. They believe that extreme values are a function of sample size and will, for the most part, increase as the number of simulated persons increases.

### 15.3.3. Relevant Population Mobility Studies

*National Association of Realtors (NAR) (1993) The Home Buying and Selling Process* - The NAR survey was conducted by mailing a questionnaire to 15,000 home buyers throughout the U.S. who purchased homes during the second half of 1993. The survey was conducted in December 1993 and 1,763 usable responses were received, equaling a response rate of 12 percent (NAR, 1993). Of the respondents, forty-one percent were first time buyers. Home buyer names and addresses were obtained from Dataman Information Services (DIS). DIS compiles information on residential real estate transactions from more than 600 counties throughout the United States using courthouse deed records. Most of the 250 Metropolitan Statistical Areas are also covered in the DIS data compilation.

The home buyers were questioned on the length of time they owned their previous home. Typical homebuyer (41%) was found to have lived in their previous home between 4 and 7 years (Table 15-169). The survey results indicate that the average tenure of home buyers is 7.1 years based on an overall residence history of the respondents (NAR, 1993). In addition, the median length of residence in respondents' previous homes was found to be 6 years (see Table 15-170).

The distances the respondents moved to their new homes were typically short distances. Data presented in Table 15-171 indicate that the mean distances range from 230 miles for new home buyers and repeat buyers to 8 years for first time buyers and existing home buyers. Seventeen (17) percent of respondents purchased homes

over 100 miles from their previous homes and 49 percent purchased homes less than 10 miles away.

*Lehman (1994) - Homeowners Relocating at Faster Pace* - Lehman (1994) presents data gathered by the Chicago Title and Trust Family Insurers. The data indicate that, in 1993, average U.S. homeowners moved every 12 years. In 1992, homeowners moved every 13.4 years and in 1991, every 14.3 years. Data from the U.S. Bureau of the Census indicate that 7 percent of the owner population moved in 1991. Based on this information, Lehman has concluded that it would take 12 years for 100 percent of owners to move. According to Lehman, Bill Harriett of the U.S. Bureau of the Census has been said that 14 years is a closer estimate for the time required for 100 percent of home owners to move. An advantage of this study is that it provides percentile data for the residential occupancy period.

## 15.4. RECOMMENDATIONS

Assessors are commonly interested in a number of specific types of time use data including time/frequencies for bathing, showering, gardening, residence time, indoor versus outdoor time, swimming, occupational tenure, and population mobility. Recommendations for each of these are discussed below. The confidence recommendations for activity patterns is presented in Table 15-172.

### 15.4.1. Recommendations for Activity Patterns

Following are recommendations for selected activities known to increase an individual's exposure to certain chemicals. These activities are time spent indoors versus outdoors and gardening, bathing and showering, swimming, residential time spent indoors and outdoors, and traveling inside a vehicle.

**Time Spent Indoors Versus Outdoors and Gardening** - Assessors often require knowledge of time individuals spend indoors versus outdoors. Ideally, this issue would be addressed on a site-specific basis since the times are likely to vary considerably depending on the climate, residential setting (i.e., rural versus urban), personal traits (i.e., age, health) and personal habits. The following general recommendation is offered in the absence of site-specific information. The key study by Robinson and Thomas (1991) compares the time use values derived in the CARB and National Studies; data are presented only for persons 12 years and older. The time use values did not differ significantly between the two studies and were averaged to provide the following recommended values. These values are applicable to



individuals 12 years and older. Approximately 21 hrs/day are spent indoors; 1.5 hrs/day are spent outdoors, and 1.5 hrs/day are spent in a vehicle.

Activities can vary significantly with differences in age. Special attention should be given to the activities of populations under the age of 12 years. Timmer et al. (1985) presented data on time spent in various activities for boys and girls ages 3-11 years. The study focused on activities performed indoors such as household work, personal care, eating, sleeping, school, studying, attending church, watching television, and engaging in household conversations. The average times spent in each indoor activity (and half the times spent in each activity which could have occurred indoors or outdoors) were summed. This procedure resulted in the following recommendations:

- Indoor activities accounted for about 78 percent of the total time in weekdays and 70 percent total time in weekend days. The corresponding times spent indoors are 19 hrs/day for weekdays and 17 hrs/day on weekends.
- Outdoor activities accounted for about 22 percent of children's time during weekdays and 30 percent during the weekend. The corresponding times spent outdoors are 5 hrs/day for weekdays and 7 hrs/day on weekends.

Assessors evaluating soil exposures are commonly interested in data on gardening times and frequencies. No data specific to time spent gardening could be found; thus, no firm recommendation could be made. However, three sets of data were found which indirectly relate to this issue which the assessor can consider in deriving time estimates for gardening:

- Robinson and Thomas (1991) estimated the time spent in "other outdoor activities" (Table 15-8) as 1 hr/day. These data apply to populations 12 years and older.
- Hill (1985) estimated that time spent in "house work and/or yard work" (Table 15-153) as 2 hr/day. These data apply to adult populations.
- Tsang and Klepeis (1996) estimated that time spent in the garden or other circumstances working with soil for persons 18-64 years old

(Table 15-62) for the 90th, 95th, and 99th percentile at 16, 40, and 200 hours/month, respectively.

U.S. EPA's Dermal Exposure Assessment Document (1992) recommends, on the basis of judgement, an event frequency for the adult gardener, working outside: 1 to 2 events/week during warmer months or about 40 events/year. An upper percentile value of 40 hours/month is recommended based on Tsang and Klepeis (1996)

**Baths and Showers** - In the NHAPS study, 649 (~7 percent) of the total participants indicated either taking or giving at least one bath in a day. Those 649 respondents were subsequently asked the number of times they took or gave a bath in one day. The majority, 459 of 649 respondents, recorded taking or giving one bath in a day. These results are presented in Table 15-24. The recommended bathing duration is 20 minutes. This is a 50th percentile value based on the NHAPS distribution shown on Table 15-26; the reported 90th percentile value is 45 minutes.

The recommended shower frequency of one shower per day is based on the NHAPS data summarized in Table 15-19. This table showed that 3,594 of the 9,386 total participants indicated taking at least one shower the previous day. When asked the number of actual showers taken the previous day, the reported results ranged from one to ten showers; a majority (76 percent), of those 3,549 respondents, reported taking one shower the previous day. The NHAPS data shown on Table 15-19, Table 15-24, and Table 15-26 provide information grouped according to gender, age, race, employment, education, day of the week, seasonal conditions, and health conditions such as asthma, angina, and bronchitis/emphysema.

Recommendations for showering duration are based on the key study conducted by Tsang and Klepeis (1996). A recommended value for average showering time is 10 minutes (Table 15-20) based on professional judgement. This approximates the average showering value (8 minutes) of James and Knuiman (1987) (Table 15-18). The recommended 50th percentile value is 15 minutes, and the 95th percentile value is 35 minutes (Table 15-21). Although these values are slightly higher than those of James and Knuiman (1987), they are believed to be more representative of U.S. households.

**Swimming** Data for swimming frequency is taken from the NHAPS Study (Tsang and Klepeis, 1996). Of 9,386 participants, 653 (about 7 percent), answered yes to



the question “in the past month, did you swim in a freshwater pool?”. The results to this question are summarized in Table 15-65. The recorded number of times respondents swam in the past month ranged from 1 to 60 with the greatest number of respondents, 147 (23 percent), reporting they swam one time per month. Thus, the recommended swimming frequency is one event/ month for the general population. The recommended swimming duration, 60 minutes per swimming event, is based on the NHAPS distribution shown on Table 15-67. Sixty minutes is based on the 50th percentile value; the 90th percentile value is 180 minutes per swimming event (based on one event/month); and the 99th percentile value is 181 minutes. This value (181) indicates that more than 180 minutes were spent.

In addition, users can obtain frequency and duration data grouped according to gender, age, race, employment, education, day of the week, and season. Frequency and duration data is also available in Table 15-65 and Table 15-67, for swimmer respondents reporting health conditions such as asthma, angina, and bronchitis/ emphysema.

**Residential Time Spent Indoors and Outdoors -**

The recommendations for time spent indoors at one’s residence is 16.4 hours/day. This is based on the NHAPS data summarized in Table 15-131 which records the 50th percentile value of 985.0 minutes per day (16.4 hours/day); and a 90th percentile value of 1,395 minutes per day (23.3 hours/day).

The recommended value for time spent outdoors at one’s residence is 2 hours per day based on Table 15-102 (generated by the NHAPS data). Values of 105 minutes per day for the 50th percentile and 362 minutes per day for the 90th percentile are shown in Table 15-102.

**Traveling Inside a Vehicle -** The recommendation for time spent in a vehicle is 1 hour and 20 minutes per day. This recommendation is based on two studies and (1) Robinson and Thomas (1991) and (2) The NHAPS data. The Robinson and Thomas study evaluated two independent studies, the CARB and the National Study. They respectively reported mean durations for time spent in a vehicle as 98 and 87 minutes per day which averages to 92 minutes per day or about 1.5 hours per day. The NHAPS data, as summarized on Table 15-133, provide a 50th percentile value of 70 minutes per day (or 1 hour and 10 minutes) and a 90th percentile value of 190 minutes per day. Thus, the averaged value from these two studies is about 1 hour and 20 minutes. NHAPS data is grouped according to gender, race, age, employment status, census

region, day of the week, season, and health condition of respondents.

**15.4.2. Recommendations: Occupational Mobility**

The median occupational tenure of the working population (109.1 million people) ages 16 years of age and older in January 1987 was 6.6 years (Carey, 1988). Since the occupational tenure varies significantly according to age it is recommended to use the age dependent values presented in Carey’s 1988 study (Table 15-158). When age cannot be determined, it is recommended to use the median tenure value of 6.6 years for working men and women 16 years and older. For persons 70 years and older, a tenure value of 21.9 years is recommended for a working lifetime. A value of 30.5 years and 18.8 years is recommended for men and women, respectively. Part-time employment, race and the position held are important to consider in determining occupational tenure. The ratings indicating confidence in the occupational mobility recommendations are presented in Table 15-173. It should be noted that the recommended values are not for use in evaluating job tenure. These data can be used for determining time spent in an occupation and not for time spent at a specific job site.

**15.4.3. Recommendations: Population Mobility**

There are three key studies from which the population mobility recommendations were derived: Israeli and Nelson (1992), U.S. Bureau of the Census (1993) - and Johnson and Capel (1992). Each study used a unique approach to estimate the length of time a person resides in a household. The respective approaches were to (1) average current and total residence time; (2) model current residence time; and (3) determine the residential occupancy period. A summary of the approaches used and values recommended by each of these studies is presented in Table 15-174.

The three studies provide residence time estimates that are very similar to the 9 year (50th percentile) and 30 year (95th percentile). Tables 15-163 and 15-164 show residence times for different types of residences and are recommended where assessors are interested in specific types of residences. The ratings indicating confidence in the population mobility recommendations is presented in Table 15-175.



#### 15.4.4. Summary of Recommended Activity Factors

Table 15-176 includes a summation of the recommended activity pattern factors presented in this section and the studies which provided data on the specific activities. The type of activities include indoor activities, outdoor activities, time inside a vehicle, taking a bath or shower, swimming, working at a specific occupation, and residing in a particular location.

#### 15.5. REFERENCES FOR CHAPTER 15

AIHC. (1994) Exposure factors sourcebook. Washington, DC. American Industrial Health Council.

Bureau of Labor Statistics. (1987) Most occupational exposures are voluntary. Washington, DC: U.S. Department of Labor.

Carey, M. (1988) Occupational tenure in 1987: Many workers have remained in their fields. *Monthly Labor Review*. October 1988. 3-12.

Carey, M. (1990) Occupational tenure, employer tenure, and occupational mobility. *Occupational Outlook Quarterly*. Summer 1990: 55-60.

Hill, M.S. (1985) Patterns of time use. In: Juster, F.T.; Stafford, F.P., eds. *Time, goods, and well-being*. Ann Arbor, MI: University of Michigan, Survey Research Center, Institute for Social Research, pp. 133-166.

Israeli, M; Nelson, C.B. (1992) Distribution and expected time of residence for U.S. households. *Risk Anal.* 12(1):65-72.

James, I.R.; Knuiman, M.W. (1987) An application of Bayes methodology to the analysis of diary records from a water use study. *J. Am. Sta. Assoc.* 82(399):705-711.

Johnson, T. and Capel, J. (1992) A monte carlo approach to simulating residential occupancy periods and its application to the general U.S. population. Research Triangle Park, NC: U.S. Environmental Protection Agency, Office of Air Quality and Standards.

Juster, F.T.; Hill, M.S.; Stafford, F.P.; Parsons, J.E. (1983) Study description. 1975-1981 time use longitudinal panel study. Ann Arbor, MI: The University of Michigan, Survey Research Center, Institute for Social Research.

Juster, F.T. (1985) A note on recent changes in time use. In: Juster, F.T.; Stafford, F.P.; eds. *Time, goods, and*

*well-being*. Ann Arbor, MI: University of Michigan, Survey Research Center, Institute for Social Research. pp. 313-330.

Lehman, H.J. (1994) Homeowners relocating at faster pace. *Virginia Homes Newspaper*, Saturday, June 15, P. E1.

National Association of Realtors (NAR). (1993) The homebuying and selling process: 1993. The Real Estate Business Series. Washington, DC: NAR.

Palisade. (1992) @Risk users guide. Newfield, NY: Palisade Corporation.

Robinson, J.P. (1977) Changes in Americans' use of time: 1965-1975. A progress report. Cleveland, OH: Cleveland State University, Communication Research Center.

Robinson, J.P.; Thomas, J. (1991) Time spent in activities, locations, and microenvironments: a California-National Comparison Project report. Las Vegas, NV: U.S. Environmental Protection Agency, Environmental Monitoring Systems Laboratory.

Sell, J. (1989) The use of children's activity patterns in the development of a strategy for soil sampling in West Central Phoenix. The Arizona Department of Environmental Quality, Phoenix, Arizona.

Sexton, K; Ryan, P.B. (1987) Assessment of human exposure to air pollution: methods, measurements, and models. In: Watson, A.; Bates, R.R.; Kennedy, D., eds. *Air pollution, the automobile and public health: research opportunities for quantifying risk*. Washington, DC: National Academy of Sciences Press.

Spencer, G. (1989) Projections of the populations of the United States by age, sex, and race: 1988 to 2080. Washington, DC: U.S. Department of Commerce, Bureau of the Census. Series, P-25, No. 1018.

Tarshis, B. (1981) The "Average American" book. New York, NY: New American Library, p. 191.

Timmer, S.G.; Eccles, J.; O'Brien, K. (1985) How children use time. In: Juster, F.T.; Stafford, F.P.; eds. *Time, goods, and well-being*. Ann Arbor, MI: University of Michigan, Survey Research Center, Institute for Social Research, pp. 353-380.

Tsang, A.M.; Klepeis, N.E. (1996) Results tables from a detailed analysis of the National Human Activity Pattern Survey (NHAPS) response. Draft Report prepared for the U.S. Environmental Protection Agency by Lockheed Martin, Contract No. 68-W6-001, Delivery Order No. 13.



U.S. Bureau of the Census. (1993) American Housing Survey for the United States in 1991. Washington, DC: U.S. Government Printing Office.

U.S. Bureau of the Census. (1993) Geographical mobility: March 1991 to March 1992. Current population reports P.20-473.

U.S. EPA. (1989) Exposure factors handbook. Washington, DC: Office of Health and Environmental Assessment. EPA/600/08-89/043.

U.S. EPA. (1992) Dermal exposure assessment: principles and applications. Washington, DC: Office of Health and Environmental Assessment. EPA No. 600/8-91-011B. Interim Report.

Wiley, J.A.; Robinson, J.P.; Cheng, Y.; Piazza, T.; Stork, L.; Plasden, K. (1991) Study of children's activity patterns. California Environmental Protection Agency, Air Resources Board Research Division. Sacramento, CA.



Table 15-1. Time Use Table Locator Guide

Percentile	Basis	Population	Application	Study	Table
Averages	Activity	Children 3-17 yrs	National	Timmer et al., 1985	15-2
Distribution	Activity	Children and Teens	National	Timmer et al., 1985	15-3
Distribution	Showering	Adults	Foreign-Australia	James and Knuiman, 1987 Tsang and Klepeis, 1996	15-4 15-24
Averages	Activity	Adults 18-64 yrs	National	Robinson and Thomas, 1991	15-5
Averages	Activity	Adults 18-64 yrs	Regional-CA	Robinson and Thomas, 1991	15-5
Averages	Microenvironment	Adults 18-64 yrs	National/Regional-CA	Robinson and Thomas, 1991	15-6
Averages	Microenvironment	Children and Adult	Regional-California	Robinson and Thomas, 1991	15-7 to 15-10
Averages	Microenvironment	Children and Adults	National	Robinson and Thomas, 1991	15-7 to 15-10
Averages	Activity	Infants and Children	Regional-California	Wiley et al., 1991	15-11
Distribution	Activity	Infants and Children	Regional-California	Wiley et al., 1991	15-12
Averages	Activity by season	Infants and Children	Regional-California	Wiley et al., 1991	15-13
Averages	Microenvironment	Infants and Children	Regional-California	Wiley et al., 1991	15-14
Distribution	Microenvironment	Infant and Children	Regional-California	Wiley et al., 1991	15-15
Averages	Microenvironment by season	Infants and Children	Regional-California	Wiley et al., 1991	15-16
Distribution	Microenvironment near pollutant	Infant and Children	Regional-California	Wiley et al., 1991	15-17
Averages	Bathing and swimming	Adults	Regional-National	USEPA, 1992 Tsang and Klepeis, 1996	15-18 15-22, 15-63
Average	Activity by employment	Adults	National	Robinson, 1977	15-147
Averages	Occupational Tenure by race and gender	Teens and Adults	National	Carey, 1988	15-157
Averages	Occupational Tenure by employment and gender	Teens and Adults	National	Carey, 1988	15-158
Distribution	Occupational Tenure by employment	Teens and Adults	National	Carey, 1988	15-159
Distribution	Occupational Mobility by age	Teens and Adults	National	Carey, 1990	15-160
Distribution	Population Mobility by locale	All ages	National	Census, 1993	Figure 15-1
Averages	Residence Time by region, setting	All ages	National	Israeli and Nelson, 1992	15-161
Distribution	Residence Time by region, setting	All ages	National	Israeli and Nelson, 1992	15-162
Distribution	Residence Time by year moved in	All ages	National	Census, 1993	15-163
Distribution	Residence Time by years in current home	All ages	National	Census, 1993	15-164
Distribution	Residence Time by gender	All ages	National	Johnson and Capel, 1992	15-165
Distribution	Residence Time by age	All ages	National	Johnson and Capel, 1992	15-166
Distribution	Residence Time by years in previous house	All ages	National	NAR, 1993	15-167
Distribution	Residence Time by tenure in previous home	All ages	National	NAR, 1993	15-168
Distribution	Relocation Distance	All ages	National	NAR, 1993	15-169



Table 15-2. Mean Time Spent (minutes) Performing Major Activities Grouped by Age, Sex and Type of Day								
Activity	Age (3-11 years)				Age (12-17 years)			
	Duration of Time (mins/day)				Duration of Time (mins/day)			
	Weekdays		Weekends		Weekdays		Weekends	
	Boys (n=118)	Girls (n=111)	Boys (n=118)	Girls (n=111)	Boys (n=77)	Girls (n=83)	Boys (n=77)	Girls (n=83)
Market Work	16	0	7	4	23	21	58	25
Household Work	17	21	32	43	16	40	46	89
Personal Care	43	44	42	50	48	71	35	76
Eating	81	78	78	84	73	65	58	75
Sleeping	584	590	625	619	504	478	550	612
School	252	259	--	--	314	342	--	--
Studying	14	19	4	9	29	37	25	25
Church	7	4	53	61	3	7	40	36
Visiting	16	9	23	37	17	25	46	53
Sports	25	12	33	23	52	37	65	26
Outdoors	10	7	30	23	10	10	36	19
Hobbies	3	1	3	4	7	4	4	7
Art Activities	4	4	4	4	12	6	11	9
Playing	137	115	177	166	37	13	35	24
TV	117	128	181	122	143	108	187	140
Reading	9	7	12	10	10	13	12	19
Household Conversations	10	11	14	9	21	30	24	30
Other Passive Leisure	9	14	16	17	21	14	43	33
NA <sup>a</sup>	22	25	20	29	14	17	10	4
Percent of Time Accounted for by Activities Above	94%	92%	93%	89%	93%	92%	88%	89%

a NA = Unknown  
Source: Timmer et al., 1985.



Age (years)	Time Duration (mins)										Significant Effects <sup>a</sup>
	Weekday					Weekend					
	3-5	6-8	9-11	12-14	15-17	3-5	6-8	9-11	12-14	15-17	
<u>Activities</u>											
Market Work	--	14	8	14	28	--	4	10	29	48	
Personal Care	41	49	40	56	60	47	45	44	60	51	A,S,AxS (F>M)
Household Work	14	15	18	27	34	17	27	51	72	60	A,S, AxS (F>M)
Eating	82	81	73	69	67	81	80	78	68	65	A
Sleeping	630	595	548	473	499	634	641	596	604	562	A
School	137	292	315	344	314	--	--	--	--	--	
Studying	2	8	29	33	33	1	2	12	15	30	A
Church	4	9	9	9	3	55	56	53	32	37	A
Visiting	14	15	10	21	20	10	8	13	22	56	A (Weekend only)
Sports	5	24	21	40	46	3	30	42	51	37	A,S (M>F)
Outdoor activities	4	9	8	7	11	8	23	39	25	26	
Hobbies	0	2	2	4	6	1	5	3	8	3	
Art Activities	5	4	3	3	12	4	4	4	7	10	
Other Passive Leisure	9	1	2	6	4	6	10	7	10	18	A
Playing	218	111	65	31	14	267	180	92	35	21	A,S (M>F)
TV	111	99	146	142	108	122	136	185	169	157	A,S, AxS (M>F)
Reading	5	5	9	10	12	4	9	10	10	18	A
Being read to	2	2	0	0	0	3	2	0	0	0	A
NA	30	14	23	25	7	52	7	14	4	9	A

a Effects are significant for weekdays and weekends, unless otherwise specified A = age effect, P<0.05, for both weekdays and weekend activities; S = sex effect P<0.05, F>M, M>F = females spend more time than males, or vice versa; and AxS = age by sex interaction, P<0.05.

Source: Timmer et al., 1985.





Table 15-4. Cumulative Frequency Distribution of Average Shower Duration for 2,550 Households

Shower duration (minutes)	Cumulative frequency (percentage)
1	0.2
2	0.8
3	3.1
4	9.6
5	22.1
6	37.5
7	51.6
8	62.5
9	72.0
10	79.4
11	84.5
12	88.4
13	90.6
14	92.3
15	93.7
16	94.9
17	95.7
18	96.7
19	97.6
20	98.0
<20	100.0

Source: Adapted from James and Knuiman, 1987.



Table 15-5. Mean Time Spent (minutes/day) in Ten Major Activity Categories Grouped by Total Sample and Gender for the CARB and National Studies (age 18-64 years)

Activity Category <sup>a</sup>	Activity Codes <sup>b</sup>	Time Duration (mins/day)					
		CARB (1987-88)		National (1985)		National (1985)	
		Total Sample n <sup>c</sup> = 1,359	Men n = 639	Women n = 720	Men n = 921	Women n = 1,059	
Paid Work	00-09	273	252	346	200	323	190
Household Work	10-19	102	118	68	137	79	155
Child Care	20-29	23	25	12	36	11	43
Obtaining Goods and Services	30-39	61	55	48	73	44	62
Personal Needs and Care	40-49	642	642	630	655	636	645
Education and Training	50-59	22	19	25	20	21	16
Organizational Activities	60-69	12	17	11	13	12	20
Entertainment/Social Activities	70-79	60	62	57	55	64	62
Recreation	80-89	43	50	53	31	69	43
Communication	90-99	202	196	192	214	197	194

a,b Time use for components of activity categories and codes are shown in Appendix Table 15A-6.  
c n = total diary days.  
Source: Robinson and Thomas, 1991

Table 15-6. Total Mean Time Spent at Three Major Locations Grouped by Total Sample and Gender for the CARB and National Study (ages 18-64 years)

Location <sup>a</sup>	Code <sup>b</sup>	Time Duration (mins/day)					
		CARB (1987-88)		National (1985)		National (1985)	
		Total Sample n <sup>c</sup> = 1359	Men n <sup>c</sup> = 39	Women n <sup>c</sup> = 720	Men n <sup>c</sup> = 921	Women n <sup>c</sup> = 1059	
At Home	WC01-13	892	822	963	886	1022	
Away From Home	WC21-40	430	487	371	445	324	
Travel	WC51-61	116	130	102	101	87	
Not Ascertained	WC99	2	1	4	8	7	
Total Time		1440	1440	1440	1440	1440	

a,b Time use data for the 44 components of location and location codes are presented in Appendix Table 15A-7.  
c n = total diary days.  
Source: Robinson and Thomas, 1991.



Table 15-7. Mean Time Spent at Three Locations for both CARB and National Studies (ages 12 years and older)

Location Category	Mean duration (mins/day)			
	CARB (n = 1762) <sup>b</sup>	S.E. <sup>a</sup>	National (n = 2762) <sup>b</sup>	S.E.
Indoor	1255 <sup>c</sup>	28	1279 <sup>c</sup>	21
Outdoor	86 <sup>d</sup>	5	74 <sup>d</sup>	4
In-Vehicle	98 <sup>d</sup>	4	87 <sup>d</sup>	2
Total Time Spent	1440		1440	
<sup>a</sup> S.E. = Standard Error of Mean <sup>b</sup> Weighted Number - National sample population was weighted to obtain a ratio of 46.5 males and 53.5 females, in equal proportion for each day of the week, and for each quarter of the year. <sup>c</sup> Difference between the mean values for the CARB and national studies is not statistically significant. <sup>d</sup> Difference between the mean values for the CARB and national studies is statistically significant at the 0.05 level. Source: Robinson and Thomas, 1991.				



Table 15-8. Mean Time Spent (minutes/day) in Various Microenvironments Grouped by Total Population and Gender (12 years and over) in the National and CARB Data

Microenvironment	National Data Mean Duration (mins/day) (standard error) <sup>a</sup>					
	N = 1284 <sup>b</sup>	"Doer" <sup>c</sup>	N = 1478 <sup>b</sup>	"Doer"	N = 2762 <sup>b</sup>	"Doer"
	Men	Men	Women	Women	Total	Total
Autoplaces	5 (1)	90	1 (0)	35	3 (0)	66
Restaurant/bar	22 (2)	73	20 (2)	79	21 (1)	77
In-vehicle	92 (3)	99	82 (3)	94	87 (2)	97
In-Vehicle/other	1 (1)	166	1 (0)	69	1 (0)	91
Physical/outdoors	24 (3)	139	11 (2)	101	17 (2)	135
Physical/indoors	11 (1)	84	6 (1)	57	8 (1)	74
Work/study-residence	17 (2)	153	15 (2)	150	16 (1)	142
Work/study-other	221 (10)	429	142 (7)	384	179 (6)	390
Cooking	14 (1)	35	52 (2)	67	34 (1)	57
Other activities/kitchen	54 (3)	69	90 (4)	102	73 (2)	88
Chores/child	88 (3)	89	153 (5)	154	123 (9)	124
Shop/errand	23 (2)	56	38 (2)	74	31 (1)	67
Other/outdoors	70 (6)	131	43 (4)	97	56 (4)	120
Social/cultural	71 (4)	118	75 (4)	110	73 (3)	118
Leisure-eat/indoors	235 (8)	241	215 (7)	224	224 (5)	232
Sleep/indoors	491 (14)	492	496 (11)	497	494 (9)	495
Microenvironment	CARB Data Mean Duration (mins/day) (standard error) <sup>a</sup>					
	N = 867 <sup>b</sup>	"Doer" <sup>c</sup>	N = 895 <sup>b</sup>	"Doer"	N = 1762 <sup>b</sup>	"Doer"
	Men	Men	Women	Women	Total	Total
Autoplaces	31 (8)	142	9 (2)	50	20 (4)	108
Restaurant/bar	45 (4)	106	28 (3)	86	36 (3)	102
In-vehicle	105 (7)	119	85 (4)	100	95 (4)	111
In-Vehicle/other	4 (1)	79	3 (2)	106	3 (1)	94
Physical/outdoors	25 (3)	131	8 (1)	86	17 (2)	107
Physical/indoors	8 (1)	63	5 (1)	70	7 (1)	68
Work/study-residence	14 (3)	126	11 (2)	120	13 (2)	131
Work/study-other	213 (14)	398	156 (11)	383	184 (9)	450
Cooking	12 (1)	43	42 (2)	65	27 (1)	55
Other activities/kitchen	38 (3)	65	60 (4)	82	49 (2)	74
Chores/child	66 (4)	75	134 (6)	140	100 (4)	109
Shop/errand	21 (3)	61	41 (3)	78	31 (2)	70
Other/outdoors	95 (9)	153	44 (4)	82	69 (5)	117
Social/cultural	47 (4)	112	59 (5)	114	53 (3)	112
Leisure-eat/indoors	223 (10)	240	251 (10)	263	237 (7)	250
Sleep/indoors	492 (17)	499	504 (15)	506	498 (12)	501

a Standard error of the mean  
b Weighted number  
c Doer = Respondents who reported participating in each activity/location spent in microenvironments.  
Source: Robinson and Thomas, 1991.



Table 15-9. Mean Time Spent (minutes/day) in Various Microenvironments by Type of Day for the California and National Surveys (sample population ages 12 years and older)

Weekday Microenvironment	Mean Duration (standard error) <sup>a</sup> (mins/day)		Mean Duration for "Doer" <sup>hb</sup> (mins/day)	
	CARB (n=1259) <sup>c</sup>	NAT (n=1973) <sup>c</sup>	CARB	NAT
	1 Autoplaces	21 (5)	3 (1)	108
2 Restaurant/Bar	29 (3)	20 (2)	83	73
3 In-Vehicle/Internal Combustion	90 (5)	85 (2)	104	95
4 In-Vehicle/Other	3 (1)	1 (0)	71	116
5 Physical/Outdoors	14 (2)	15 (2)	106	118
6 Physical/Indoors	7 (1)	8 (1)	64	68
7 Work/Study-Residence	14 (2)	16 (2)	116	147
8 Work/Study-Other	228 (11)	225 (8)	401	415
9 Cooking	27 (2)	35 (2)	58	57
10 Other Activities/Kitchen	51 (3)	73 (3)	76	87
11 Chores/Child	99 (5)	124 (4)	108	125
12 Shop/Errand	30 (2)	30 (2)	67	63
13 Other/Outdoors	67 (6)	51 (4)	117	107
14 Social/Cultural	42 (3)	62 (3)	99	101
15 Leisure-Eat/Indoors	230 (9)	211 (6)	244	218
16 Sleep/Indoors	490 (14)	481 (10)	495	483

Weekend Microenvironment	Mean Duration (standard error) <sup>a</sup> (mins/day)		Mean Duration for "Doer" <sup>hb</sup> (mins/day)	
	CARB (n=503) <sup>c</sup>	NAT (n=789) <sup>c</sup>	CARB	NAT
	1 Autoplaces	19 (4)	3 (1)	82
2 Restaurant/Bar	55 (6)	23 (2)	127	84
3 In-Vehicle/Internal Combustion	108 (8)	91 (6)	125	100
4 In-Vehicle/Other	5 (3)	0 (0)	130	30
5 Physical/Outdoors	23 (3)	23 (4)	134	132
6 Physical/Indoors	7 (1)	9 (2)	72	80
7 Work/Study-Residence	10 (2)	15 (3)	155	165
8 Work/Study-Other	74 (11)	64 (6)	328	361
9 Cooking	27 (2)	34 (2)	60	55
10 Other Activities/Kitchen	44 (3)	73 (4)	71	90
11 Chores/Child	103 (7)	120 (5)	114	121
12 Shop/Errand	35 (4)	35 (3)	81	75
13 Other/Outdoors	74 (7)	67 (7)	126	132
14 Social/Cultural	79 (7)	99 (6)	140	141
15 Leisure-Eat/Indoors	256 (12)	257 (11)	273	268
16 Sleep/Indoors	520 (20)	525 (17)	521	525

<sup>a</sup> Standard Error of Mean  
<sup>b</sup> Doer = Respondent who reported participating in each activity/location spent in microenvironments.  
<sup>c</sup> Weighted Number

Source: Robinson and Thomas, 1991.



Table 15-10. Mean Time Spent (minutes/day) in Various Microenvironments by Age Groups for the National and California Surveys

Microenvironment	National Data Mean Duration (Standard Error) <sup>f</sup>									
	Age 12-17 years N=340 <sup>b</sup>		Age 18-24 years N=340		Age 24-44 years N=340		Age 45-64 years N=340		Age 65+ years N=340	
		"Doer" <sup>c</sup>		"Doer"		"Doer"		"Doer"		"Doer"
Autoplaces	2 (1)	73	7 (2)	137	2 (1)	43	4 (1)	73	4 (2)	57
Restaurant/bar	9 (2)	60	28 (3)	70	25 (3)	86	19 (2)	67	20 (5)	74
In-vehicle/internal combustion	79 (7)	88	103 (8)	109	94 (4)	101	82 (5)	91	62 (5)	80
In-vehicle/other	0 (0)	12	1 (1)	160	1 (0)	80	1 (1)	198	1 (1)	277
Physical/outdoors	32 (8)	130	17 (4)	110	19 (4)	164	7 (1)	79	15 (4)	81
Physical/indoors	15 (3)	87	8 (2)	76	7 (1)	71	7 (2)	77	7 (1)	51
Work/study-residence	22 (4)	82	19 (6)	185	16 (2)	181	9 (2)	169	5 (3)	297
Work/study-other	159 (14)	354	207 (20)	391	220 (11)	422	180 (13)	429	35 (6)	341
Cooking	11 (3)	40	18 (2)	39	38 (2)	57	43 (3)	64	50 (5)	65
Other activities/kitchen	53 (4)	64	42 (3)	55	70 (4)	86	90 (6)	101	108 (9)	119
Chores/child	91 (7)	92	124 (9)	125	133 (6)	134	121 (6)	122	119 (7)	121
Shop/errands	26 (4)	68	31 (4)	65	33 (2)	66	33 (3)	67	35 (5)	69
Other/outdoors	70 (13)	129	34 (4)	84	48 (6)	105	60 (7)	118	82 (13)	140
Social/cultural	87 (10)	120	100 (12)	141	56 (3)	94	73 (6)	116	85 (8)	122
Leisure-eat/indoors	237 (16)	242	181 (11)	189	200 (8)	208	238 (11)	244	303 (20)	312
Sleep/indoors	548 (31)	551	511 (26)	512	479 (14)	480	472 (15)	472	507 (26)	509



Table 15-10. Mean Time Spent (minutes/day) in Various Microenvironments by Age Groups (continued)

Microenvironment	CARB Data Mean Duration (Standard Error) <sup>a</sup>									
	Age 12-17 years N=183 <sup>b</sup>		Age 18-24 years N=250		Age 24-44 years N=749		Age 45-64 years N=406		Age 65+ years N=158	
		"Doer" <sup>c</sup>		"Doer"		"Doer"		"Doer"		"Doer"
Autoplaces	16 (8)	124	16 (4)	71	25 (9)	114	20 (5)	94	9 (2)	53
Restaurant/bar	16 (4)	44	40 (8)	98	44 (5)	116	31 (4)	82	25 (7)	99
In-vehicle/internal combustion	78 (11)	89	111 (13)	122	98 (5)	111	100 (11)	117	63 (8)	89
In-vehicle/other	1 (0)	19	3 (1)	60	5 (2)	143	2 (1)	56	2 (1)	53
Physical/outdoors	32 (7)	110	13 (3)	88	17 (3)	128	14 (3)	123	15 (4)	104
Physical/indoors	20 (4)	65	5 (2)	77	6 (1)	61	5 (1)	77	3 (1)	48
Work/study-residence	25 (5)	76	30 (11)	161	7 (2)	137	10 (3)	139	5 (3)	195
Work/study-other	196 (30)	339	201 (24)	344	215 (14)	410	173 (20)	429	30 (11)	336
Cooking	3 (1)	19	14 (2)	40	32 (2)	59	31 (3)	68	41 (7)	69
Other activities/kitchen	31 (4)	51	31 (5)	55	43 (3)	65	62 (6)	91	97 (14)	119
Chores/child	72 (11)	77	79 (8)	85	110 (6)	119	99 (8)	109	123 (15)	141
Shop/errands	14 (3)	50	35 (7)	71	33 (4)	71	32 (3)	77	35 (5)	76
Other/outdoors	58 (8)	78	80 (15)	130	68 (8)	127	76 (12)	134	55 (7)	101
Social/cultural	63 (14)	109	65 (10)	110	50 (5)	122	50 (5)	107	49 (7)	114
Leisure-eat/indoors	260 (27)	270	211 (19)	234	202 (9)	215	248 (15)	261	386 (34)	394
Sleep/indoors	557 (44)	560	506 (30)	510	487 (17)	491	485 (23)	491	502 (31)	502

<sup>a</sup> Standard error.  
<sup>b</sup> All N's are weighted number.  
<sup>c</sup> Doer = Respondents who reported participating in each activity/location spent in microenvironments.  
Source: Robinson and Thomas, 1991.



Table 15-11. Mean Time (minutes/day) Children Spent in Ten Major Activity Categories for All Respondents

Activity Category	Mean Duration (mins/day)	% Doing	Mean Duration for Doers <sup>b</sup> (mins/day)	Median Duration for Doer (mins/day)	Maximum Duration for Doers (mins/day)	Detailed Activity with Highest Avg. Minutes (code)
Work-related <sup>a</sup>	10	25	39	30	405	Eating at work/school/daycare (06)
Household	53	86	61	40	602	Travel to household (199)
Childcare	< 1	< 1	83	30	290	Other child care (27)
Goods/Services	21	26	81	60	450	Errands (38)
Personal Needs and Care <sup>c</sup>	794	100	794	770	1440	Night sleep (45)
Education <sup>d</sup>	110	35	316	335	790	School classes (50)
Organizational Activities	4	4	111	105	435	Attend meetings (60)
Entertain/Social	15	17	87	60	490	Visiting with others (75)
Recreation	239	92	260	240	835	Games (87)
Communication/Passive Leisure	192	93	205	180	898	TV use (91)
Don't know/Not coded	2	4	41	15	600	--
All Activities <sup>e</sup>	1441					

<sup>a</sup> Includes eating at school or daycare, an activity not grouped under the "education activities" (codes 50-59, 549).  
<sup>b</sup> "Doers" indicate the respondents who reported participating in each activity category.  
<sup>c</sup> Personal care includes night sleep and daytime naps, eating, travel for personal care.  
<sup>d</sup> Education includes student and other classes, homework, library, travel for education.  
<sup>e</sup> Column total may not sum to 1440 due to rounding error  
Source: Wiley et al., 1991.

Table 15-12. Mean Time Children Spent in Ten Major Activity Categories Grouped by Age and Gender

Activity Category	Mean Duration (minutes/day)									
	Boys					Girls				
	0-2 yrs	3-5 yrs	6-8 yrs	9-11 yrs	All Ages	0-2 yrs	3-5 yrs	6-8 yrs	9-11 yrs	All Ages
Work-related	4	9	14	12	10	5	12	11	10	10
Household	33	45	55	65	48	58	44	51	76	57
Childcare	0	0	0	1	<1	0	0	0	4	1
Goods/Services	20	22	19	14	19	22	25	23	22	23
Personal Needs and Care <sup>a</sup>	914	799	736	690	792	906	816	766	701	797
Education <sup>b</sup>	60	67	171	138	106	41	95	150	176	115
Organizational Activities	1	3	7	6	4	6	1	4	6	4
Entertainment/Social	3	15	5	34	13	5	16	9	36	17
Recreation	217	311	236	229	250	223	255	238	194	228
Communication/Passive Leisure	187	166	195	250	197	171	173	189	213	186
Don't know/Not coded	1	4	1	1	2	3	1	<1	3	2
All Activities <sup>c</sup>	1440	1441	1439	1440	1442	1440	1438	1441	1441	1440
Sample Sizes Unweighted N's	172	151	145	156	624	141	151	124	160	576

<sup>a</sup> Personal needs and care includes night sleep and daytime naps, eating, travel for personal care.  
<sup>b</sup> Education includes student and other classes, homework, library, travel for education.  
<sup>c</sup> The column totals may differ from 1440 due to rounding error.  
Source: Wiley et al., 1991.





Activity Category	Mean Duration (minutes/day)								
	Season					Region of California			
	Winter (Jan-Mar)	Spring (Apr-June)	Summer (July-Sept)	Fall (Oct-Dec)	All Seasons	So. Coast	Bay Area	Rest of State	All Regions
Work-related	10	10	6	13	10	10	10	8	10
Household	47	58	53	52	53	45	62	55	53
Childcare	<1	1	<1	<1	<1	<1	<1	1	<1
Goods/Services	19	17	26	23	21	20	21	23	21
Personal Needs and Care <sup>a</sup>	799	774	815	789	794	799	785	794	794
Education <sup>b</sup>	124	137	49	131	110	109	115	109	110
Organizational Activities	3	5	5	3	4	2	6	6	4
Entertainment/Social	14	12	12	22	15	17	10	16	15
Recreation	221	243	282	211	239	230	241	249	239
Communication/Passive Leisure	203	180	189	195	192	206	190	175	192
Don't know/Not coded	<1	2	3	<1	2	1	1	3	2
All Activities <sup>c</sup>	1442	1439	1441	1441	1441	1440	1442	1439	1441
Sample Sizes (Unweighted)	318	204	407	271	1200	224	263	713	1200

<sup>a</sup> Personal needs and care includes night sleep and daytime naps, eating, travel for personal care.  
<sup>b</sup> Education includes student and other classes, homework, library, travel for education.  
<sup>c</sup> The column totals may not be equal to 1440 due to rounding error.  
 Source: Wiley et al., 1991.

Location Category	Mean Duration (mins)	% Doing	Mean Duration for Doers (mins)	Median Duration for Doers (mins)	Maximum Duration for Doers (mins)	Detailed Location with Highest Avg. Time
Home	1,078	99	1,086	1,110	1,440	Home - bedroom
School/Childcare	109	33	330	325	1,260	School or daycare facility
Friend's/Other's House	80	32	251	144	1,440	Friend's/other's house - bedroom
Stores, Restaurants, Shopping Places	24	35	69	50	475	Shopping mall
In-transit	69	83	83	60	1,111	Traveling in car
Other Locations	79	57	139	105	1,440	Park, playground
Don't Know/Not Coded	<1	1	37	30	90	--
All Locations	1,440					

Source: Wiley et al., 1991.



Table 15-15. Mean Time Children Spent in Six Location Categories Grouped by Age and Gender										
Location Category	Mean Duration (minutes/day)									
	Boys					Girls				
	0-2 yrs	3-5 yrs	6-8 yrs	9-11 yrs	All Boys	0-2 yrs	3-5 yrs	6-8 yrs	9-11 yrs	All Girls
Home	1,157	1,134	1,044	1,020	1,094	1,151	1,099	1,021	968	1,061
School/Childcare	86	88	144	120	108	59	102	133	149	111
Friend's/Other's House	67	73	77	109	80	56	47	125	102	80
Stores, Restaurants, Shopping Places	21	25	22	15	21	23	35	27	26	28
In-transit	54	62	61	62	59	76	88	53	93	79
Other Locations	54	58	92	114	77	73	68	81	102	81
Don't Know/Not Coded	<1	<1	<1	<1	<1	<1	<1	<1	<1	<1
All Locations <sup>a</sup>	1,439	1,440	1,439	1,440	1,439	1,438	1,440	1,440	1,440	1,440
Sample Sizes (Unweighted)	172	151	145	156	624	141	151	124	160	576

<sup>a</sup> The column totals may not sum to 1,440 due to rounding error.  
Source: Wiley et al., 1991.

Table 15-16. Mean Time Children Spent in Six Location Categories Grouped by Season and Region										
Location Category	Mean Duration (minutes/day)									
	Season					Region of California				
	Winter (Jan-Mar)	Spring (Apr-June)	Summer (July-Sept)	Fall (Oct-Dec)	All Seasons	So. Coast	Bay Area	Rest of State	All Regions	
Home	1,091	1,042	1,097	1,081	1,078	1,078	1,078	1,078	1,078	
School/Childcare	119	141	52	124	109	113	103	108	109	
Friend's/Other's House	69	75	108	69	80	73	86	86	80	
Stores, Restaurants, Shopping Places	22	21	30	24	24	26	23	23	24	
In-transit	75	75	60	65	69	71	73	63	69	
Other Locations	63	85	93	76	79	79	76	81	79	
Don't Know/Not Coded	<1	<1	<1	<1	<1	<1	<1	<1	<1	
All Locations <sup>a</sup>	1,439	1,439	1,440	1,439	1,439	1,439	1,440	1,440	1,439	
Sample Sizes (Unweighted N's)	318	204	407	271	1,200	224	263	713	1,200	

<sup>a</sup> The column totals may not sum to 1,440 due to rounding error.  
Source: Wiley et al., 1991.



Table 15-17. Mean Time Children Spent in Proximity to Three Potential Exposures Grouped by All Respondents, Age, and Gender												
Potential Exposures	Mean Duration (minutes/day)											
	All Children	Boys					Girls					All Girls
		0-2 yrs	3-5 yrs	6-8 yrs	9-11 yrs	All Boys	0-2 yrs	3-5 yrs	6-8 yrs	9-11 yrs		
Tobacco Smoke	77	115	75	66	66	82	77	68	71	74	73	
Gasoline Fumes	2	2	1	1	4	2	1	1	3	1	1	
Gas Oven Fumes	11	10	15	12	11	12	12	10	10	7	10	
Sample Sizes (Unweighted N's)	1,166 <sup>a</sup>	168	148	144	150	610	140	147	122	147	556	

<sup>a</sup> Respondents with missing data were excluded.  
Source: Wiley et al., 1991.

Table 15-18. Range of Recommended Defaults for Dermal Exposure Factors						
	Water Contact				Soil Contact	
	Bathing		Swimming		Central	Upper
	Central	Upper	Central	Upper		
Event time and frequency <sup>a</sup>	10 min/event 1 event/day 350 days/yr	15 min/event 1 event/day 350 days/yr	0.5 hr/event 1 event/day 5 days/yr	1.0 hr/event 1 event/day 150 days/yr	40 events/yr	350 events/yr
Exposure duration	9 years	30 years	9 years	30 years	9 years	30 years

<sup>a</sup> Bathing event time is presented to be representative of baths as well as showers.  
Source: U.S. EPA 1992.



Table 15-19. Number of Times Taking a Shower at Specified Daily Frequencies by the Number of Respondents

	Total N	Times/Day									
		0	1	2	3	4	5	8	10	11:1-0+	DK
<b>Overall</b>	3594	2	2747	802	30	1	1	1	1	4	5
<b>Gender</b>											
Male	1720	*	1259	436	21	1	*	*	*	1	2
Female	1872	2	1486	366	9	*	1	1	1	3	3
Refused	2	*	2	*	*	*	*	*	*	*	*
<b>Age (years)</b>											
64	64	*	46	17	*	*	*	*	*	*	1
1-4	41	*	30	9	1	*	*	*	*	*	1
5-11	140	*	112	26	1	*	*	*	*	*	1
12-17	270	*	199	65	6	*	*	*	*	*	*
18-64	2650	1	1983	636	21	1	1	1	1	3	2
> 64	429	1	377	49	1	*	*	*	*	1	*
<b>Race</b>											
White	2911	2	2323	562	17	*	1	*	*	4	2
Black	349	*	199	140	7	1	*	1	*	*	1
Asian	64	*	49	14	1	*	*	*	*	*	*
Some Others	65	*	40	23	2	*	*	*	*	*	*
Hispanic	162	*	103	56	2	*	*	*	1	*	*
Refused	43	*	33	7	1	*	*	*	*	*	2
<b>Hispanic</b>											
No	3269	2	2521	711	24	1	1	1	*	4	4
Yes	277	*	190	81	5	*	*	*	1	*	*
DK	17	*	13	4	*	*	*	*	*	*	*
Refused	31	*	23	6	1	*	*	*	*	*	1
<b>Employment</b>											
*	439	*	330	99	8	*	*	*	*	*	2
Full Time	1838	1	1361	454	17	*	*	*	1	2	2
Part Time	328	1	261	65	*	*	1	*	*	*	*
Not Employed	967	*	780	177	5	1	*	1	*	2	1
Refused	22	*	15	7	*	*	*	*	*	*	*
<b>Education</b>											
*	515	*	382	121	9	*	*	*	*	*	3
< High School	297	*	240	54	2	*	*	*	*	1	*
High School Graduate	1042	1	789	243	5	*	1	1	*	1	1
< College	772	1	589	176	4	*	*	1	*	1	1
College Graduate	576	*	434	133	7	1	*	*	*	1	*
Post Graduate	392	*	313	75	3	*	*	*	*	1	*
<b>Census Region</b>											
Northeast	828	*	622	196	7	*	*	*	*	*	3
Midwest	756	*	621	131	3	*	*	*	*	*	1
South	1246	1	893	334	14	1	*	*	*	3	*
West	764	1	611	141	6	*	1	1	1	1	1
<b>Day of Week</b>											
Weekday	2481	*	1889	563	17	1	1	1	1	4	4
Weekend	1113	2	858	239	13	*	*	*	*	*	1
<b>Season</b>											
Winter	941	*	732	198	9	*	*	*	*	1	1
Spring	889	*	674	205	7	*	*	*	1	*	2
Summer	1003	*	735	254	10	1	*	*	*	2	1
Fall	761	2	606	145	4	*	1	1	*	1	1
<b>Asthma</b>											
No	3312	2	2543	730	25	1	1	1	1	4	4
Yes	261	*	189	67	5	*	*	*	*	*	*
DK	21	*	15	5	*	*	*	*	*	*	1
<b>Angina</b>											
No	3481	1	2653	786	29	1	1	1	1	4	4
Yes	91	1	77	12	1	*	*	*	*	*	*
DK	22	*	17	4	*	*	*	*	*	*	1
<b>Bronchitis/Emphysema</b>											
No	3419	2	2620	758	27	1	1	1	1	4	4
Yes	154	*	112	39	3	*	*	*	*	*	*
DK	21	*	15	5	*	*	*	*	*	*	1

Note: \* Signifies missing data; Dk= don't know; N = sample size.  
 Source: Tsang and Klepeis,1996



	Total N	Minutes/Shower							
		*.*	0-10	10-20	20-30	30-40	40-50	50-60	60-61
<b>Overall</b>	3594	47	1640	1348	397	72	52	51	17
<b>Gender</b>									
Male	1720	13	788	625	213	35	25	14	7
Female	1872	34	850	693	184	37	27	37	10
Refused	2	*	2	*	*	*	*	*	*
<b>Age</b>									
*	64	6	27	23	3	1	*	2	2
1-4	41	1	13	14	10	1	*	2	*
5-11	140	1	60	52	18	3	2	4	*
12-17	270	2	94	104	40	13	9	7	1
18-64	2650	16	1238	977	288	50	37	33	11
>64	429	21	208	148	38	4	4	3	3
<b>Race</b>									
White	2911	38	1406	1070	292	39	31	26	9
Black	349	5	115	120	58	20	11	16	4
Asian	64	*	25	25	10	1	2	*	1
Some Others	65	*	18	29	6	3	4	4	1
Hispanic	162	1	57	60	25	8	4	5	2
Refused	43	3	19	14	6	1	*	*	*
<b>Hispanic</b>									
No	3269	43	1526	1188	352	61	42	44	13
Yes	277	1	98	109	40	10	8	7	4
DK	17	*	5	9	1	*	2	*	*
Refused	31	3	11	12	4	1	*	*	*
<b>Employment</b>									
*	439	4	163	165	66	17	10	12	2
Full Time	1838	10	875	682	191	32	20	20	8
Part Time	328	4	160	112	39	4	5	3	1
Not Employed	967	27	431	355	97	19	16	16	6
Refused	22	2	11	4	4	*	1	*	*
<b>Education</b>									
*	515	10	190	186	79	21	13	14	2
< High School	297	8	93	125	51	6	7	6	1
High School Graduate	1042	12	451	409	108	23	17	16	6
< College	772	12	377	271	79	14	6	7	6
College Graduate	576	2	297	211	50	5	5	5	1
Post Graduate	392	3	232	116	30	3	4	3	1
<b>Census Region</b>									
Northeast	828	7	374	326	79	15	11	12	4
Midwest	756	11	385	253	70	16	9	9	3
South	1246	26	490	461	179	35	26	23	6
West	764	3	391	278	69	6	6	7	4
<b>Day of Week</b>									
Weekday	2481	34	1134	908	279	46	38	32	10
Weekend	1113	13	506	410	118	26	14	19	7
<b>Season</b>									
Winter	941	12	421	358	95	18	15	16	6
Spring	889	14	410	314	93	21	14	18	5
Summer	1003	11	435	366	128	29	17	12	5
Fall	761	10	374	280	81	4	6	5	1
<b>Asthma</b>									
No	3312	38	1526	1222	362	65	44	41	14
Yes	261	4	108	89	33	7	8	10	2
DK	21	5	6	7	2	*	*	*	1
<b>Angina</b>									
No	3481	36	1591	1276	389	70	51	51	17
Yes	91	7	38	36	8	1	1	*	*
DK	22	4	11	6	*	1	*	*	*
<b>Bronchitis/Emphysema</b>									
No	3419	40	1566	1258	375	67	47	50	16
Yes	154	3	66	54	19	5	5	1	1
DK	21	4	8	6	3	*	*	*	*

NOTE: \* - Missing data; DK = don't know; N = sample size; Refused = Refused to answer. A value of 61 for number of minutes signifies that more than 60 minutes were spent.  
Source: Tsang and Klepeis, 1996.



Table 15-21. Number of Minutes Spent Taking a Shower (minutes/shower)

Category	Population Group	Total N	Percentiles											
			1	2	5	10	25	50	75	91	95	98	99	100
Overall		3547	3	4	5	5	10	15	20	30	35	50	60	61
Gender	Male	1707	3	4	5	5	10	15	20	30	30	45	60	61
Gender	Female	1838	3	4	5	5	10	15	20	30	40	60	60	61
Age (years)	1-4	40	5	5	5	5	5	10	17.5	30	50	60	60	60
Age (years)	5-11	139	3	4	5	5	10	15	20	30	40	60	60	60
Age (years)	12-17	268	5	5	5	7	10	15	25	35	45	60	60	61
Age (years)	18-64	2634	3	3	5	5	10	15	20	30	30	45	60	61
Age (years)	>64	408	3	3	5	5	10	10	20	30	30	45	60	61
Race	White	2873	3	4	5	5	10	13	20	30	30	45	60	61
Race	Black	344	4	4	5	6	10	20	30	40	60	60	61	61
Race	Asian	64	1	3	4	5	10	15	20	30	40	48	61	61
Race	Some Others	65	3	3	5	10	10	15	30	45	60	60	61	61
Race	Hispanic	161	3	4	5	6	10	15	25	40	45	60	61	61
Hispanic	No	3226	3	4	5	5	10	15	20	30	30	45	60	61
Hispanic	Yes	276	3	4	5	6	10	15	22.5	39	45	60	61	61
Employment	Full Time	1828	3	4	5	5	10	15	20	30	30	45	60	61
Employment	Part Time	324	2	3	5	5	10	12	20	30	30	45	60	60
Employment	Not Employed	940	3	3	5	5	10	15	20	30	40	60	60	61
Education	< High School	289	4	5	5	8	10	15	20	30	40	60	60	61
Education	High School Graduate	1030	2	3	5	5	10	15	20	30	40	60	60	61
Education	< College	760	3	5	5	5	10	12	20	30	30	45	60	61
Education	College Graduate	574	3	3	5	5	10	10	20	25	30	40	60	61
Education	Post Graduate	389	2	3	4	5	7	10	15	25	30	45	60	61
Census Region	Northeast	821	4	5	5	5	10	15	20	30	32	50	60	61
Census Region	Midwest	745	3	4	5	5	10	10	20	30	30	45	60	61
Census Region	South	1220	3	3	5	5	10	15	20	30	40	60	60	61
Census Region	West	761	2	3	5	5	10	10	15	30	30	45	60	61
Day of Week	Weekday	2447	3	4	5	5	10	15	20	30	35	48	60	61
Day of Week	Weekend	1100	3	4	5	5	10	15	20	30	40	60	60	61
Season	Winter	929	3	4	5	5	10	15	20	30	40	60	60	61
Season	Spring	875	3	4	5	5	10	15	20	30	40	60	60	61
Season	Summer	992	2	3	5	5	10	15	20	30	40	45	60	61
Season	Fall	751	3	4	5	5	10	12	20	30	30	40	48	61
Asthma	No	3274	3	4	5	5	10	15	20	30	32	45	60	61
Asthma	Yes	257	3	4	5	5	10	15	20	40	50	60	60	61
Angina	No	3445	3	4	5	5	10	15	20	30	35	50	60	61
Angina	Yes	84	3	4	5	5	10	15	15	30	30	40	45	45
Bronchitis/Emphysema	No	3379	3	4	5	5	10	15	20	30	35	50	60	61
Bronchitis/Emphysema	Yes	151	3	4	5	5	10	15	20	30	40	48	60	61

NOTE: A value of 61 for number of minutes signifies that more than 60 minutes were spent. N = doer sample size. Percentiles are the percentage of doers below or equal to a given number of minutes.  
Source: Tsang and Klepeis, 1996.



Table 15-22. Time (minutes) Spent in the Shower Room Immediately After Showering by the Number of Respondents										
	Total N	Minutes/Shower								
		*.*	0-0	0-10	10-20	20-30	30-40	40-50	50-60	61-61
<b>Overall</b>	3594	61	241	2561	509	138	24	28	27	5
<b>Gender</b>										
Male	1720	22	113	1316	207	46	5	4	6	1
Female	1872	39	128	1243	302	92	19	24	21	4
Refused	2	*	*	2	*	*	*	*	*	*
<b>Age (years)</b>										
* 1-4	64	6	9	37	7	3	*	1	1	*
5-11	41	*	5	31	3	1	*	*	*	*
12-17	140	3	9	110	14	3	*	*	1	*
18-64	270	1	17	206	29	10	3	2	1	1
> 64	2650	31	171	1897	388	99	19	18	23	4
	429	20	30	280	68	22	2	6	1	*
<b>Race</b>										
White	2911	39	189	2074	430	110	20	23	21	5
Black	349	8	23	254	42	17	*	3	2	*
Asian	64	*	7	45	9	2	*	*	1	*
Some Others	65	3	7	41	6	3	3	1	1	*
Hispanic	162	6	11	118	19	4	1	1	2	*
Refused	43	5	4	29	3	2	*	*	*	*
<b>Hispanic</b>										
No	3269	48	216	2328	470	130	23	26	23	5
Yes	277	8	19	200	35	8	1	2	4	*
DK	17	1	2	11	3	*	*	*	*	*
Refused	31	4	4	22	1	*	*	*	*	*
<b>Employment</b>										
* Full Time	439	4	28	336	48	14	3	4	2	?*
Part Time	1838	20	109	1332	267	71	12	11	16	*
Not Employed	328	5	21	223	55	13	4	4	3	*
Refused	967	29	81	655	138	39	5	9	6	5
	22	3	2	15	1	1	*	*	*	*
<b>Education</b>										
* < High School	515	11	38	390	51	15	3	4	2	1
High School Graduate	297	14	18	193	48	16	*	6	1	1
< College	1042	17	68	733	160	37	6	7	13	1
College Graduate	772	11	56	536	118	33	7	4	5	2
Post Graduate	576	3	28	426	86	19	8	3	3	*
	392	5	33	283	46	18	*	4	3	*
<b>Census Region</b>										
Northeast	828	6	61	603	116	20	6	8	8	*
Midwest	756	19	39	536	118	29	5	3	7	*
South	1246	26	74	885	171	58	10	15	4	3
West	764	10	67	537	104	31	3	2	8	2
<b>Day of Week</b>										
Weekday	2481	43	165	1784	342	88	20	16	19	4
Weekend	1113	18	76	777	167	50	4	12	8	1
<b>Season</b>										
Winter	941	11	50	678	138	36	13	9	4	2
Spring	889	13	56	636	125	37	4	8	9	1
Summer	1003	25	92	691	138	39	5	5	7	1
Fall	761	12	43	556	108	26	2	6	7	1
<b>Asthma</b>										
No	3312	52	225	2374	465	123	19	24	26	4
Yes	261	2	14	178	42	15	5	3	1	1
DK	21	7	2	9	2	*	*	1	*	*
<b>Angina</b>										
No	3481	52	233	2495	486	132	24	27	27	5
Yes	91	3	5	55	22	5	*	1	*	*
DK	22	6	3	11	1	1	*	*	*	*
<b>Bronchitis/Emphysema</b>										
No	3419	53	226	2446	482	131	23	27	26	5
Yes	154	2	12	104	26	7	1	1	1	*
DK	21	6	3	11	1	*	*	*	*	*

NOTE: \* Signifies missing data. DK= respondents answered don't know. Refused = respondents refused to answer. N = doer sample size in specified range of number of minutes spent. A value of 61 for number of minutes signifies that more than 60 minutes were spent.  
Source: Tsang and Klepeis,1996



Table 15-23. Number of Minutes Spent in the Shower Room Immediately After Showering (minutes/shower)

Category	Population Group	N	Percentiles											
			1	2	5	10	25	50	75	90	95	98	99	100
Overall		3533	0	0	0	1	3	5	10	20	30	40	50	61
Gender	Male	1698	0	0	0	1	3	5	10	15	20	30	30	61
Gender	Female	1833	0	0	0	1	3	5	12	20	30	45	60	61
Age (years)	1-4	41	0	0	0	0	1	5	10	15	20	45	45	45
Age (years)	5-11	137	0	0	0	1	2	5	10	15	20	30	30	60
Age (years)	12-17	2619	0	0	0	1	3	5	10	20	30	40	52	61
Age (years)	18-64	2619	0	0	0	1	3	5	10	20	30	40	52	61
Age (years)	> 64	409	0	0	0	1	4	5	10	20	30	35	45	60
Race	White	2872	0	0	0	1	3	5	10	20	30	40	50	61
Race	Black	341	0	0	0	1	3	5	10	20	25	30	45	60
Race	Asian	64	0	0	0	0	2	5	10	15	20	30	60	60
Race	Some Others	62	0	0	0	0	3	5	10	30	35	45	52	52
Race	Hispanic	156	0	0	0	1	3	5	10	20	25	40	60	60
Hispanic	No	3221	0	0	0	1	3	5	10	20	30	40	50	61
Hispanic	Yes	269	0	0	0	1	3	5	10	20	25	45	60	60
Employment	Full Time	1818	0	0	0	1	3	5	10	20	30	35	50	60
Employment	Part Time	323	0	0	0	1	3	5	10	20	30	45	50	60
Employment	Not Employed	938	0	0	0	1	3	5	10	20	30	45	60	61
Education	< High School	283	0	0	0	1	3	5	15	20	30	45	45	61
Education	High School Graduate	1025	0	0	0	1	3	5	10	20	30	45	60	61
Education	< College	761	0	0	0	1	3	5	10	20	30	35	50	61
Education	College Graduate	573	0	0	1	1	3	5	10	20	30	35	45	60
Education	Post Graduate	387	0	0	0	1	2	5	10	20	30	30	45	60
Census Region	Northeast	822	0	0	0	1	3	5	10	20	25	40	50	60
Census Region	Midwest	737	0	0	0	1	3	5	10	20	30	35	45	60
Census Region	South	1220	0	0	0	1	3	5	10	20	30	40	45	61
Census Region	West	754	0	0	0	1	2	5	10	20	30	30	60	61
Day of Week	Weekday	2438	0	0	0	1	3	5	10	20	30	40	50	61
Day of Week	Weekend	1095	0	0	0	1	3	5	10	20	30	40	50	61
Season	Winter	930	0	0	0	1	4	5	10	20	30	40	45	61
Season	Spring	876	0	0	0	1	2	5	10	20	30	45	60	61
Season	Summer	978	0	0	0	1	3	5	10	20	30	30	50	61
Season	Fall	749	0	0	0	1	3	5	10	20	25	40	53	61
Asthma	No	3260	0	0	0	1	3	5	10	20	30	38	50	61
Asthma	Yes	259	0	0	0	1	3	5	13	20	30	40	45	61
Angina	No	3429	0	0	0	1	3	5	10	20	30	40	50	61
Angina	Yes	88	0	0	0	2	3	8.5	15	20	30	30	45	45
Bronchitis/Emphysema	No	3366	0	0	0	1	3	5	10	20	30	40	50	61
Bronchitis/Emphysema	Yes	152	0	0	0	1	2.5	5	10	20	30	30	45	60

NOTE: N = doer sample size. Percentiles are the percentage of doers below or equal to a given number of minutes. A value of 61 for number of minutes signifies that more than 60 minutes were spent.  
Source: Tsang and Klepeis, 1996





Table 15-24. Number of Baths Given or Taken in One Day by Number of Respondents												
	Total N	Number of Baths/Day										
		1	2	3	4	5	6	7	10	11	15	DK
<b>Overall</b>	649	459	144	20	9	4	2	1	1	1	3	5
<b>Gender</b>												
Male	159	117	33	5	1	*	1	1	*	*	1	*
Female	490	342	111	15	8	4	1	*	1	1	2	5
<b>Age (years)</b>												
*	9	8	1	*	*	*	*	*	*	*	*	*
18-64	491	322	127	20	9	4	2	1	1	1	2	2
> 64	149	129	16	*	*	*	*	*	*	*	1	3
<b>Race</b>												
White	487	364	92	13	7	2	1	*	*	1	2	5
Black	106	68	29	5	1	*	1	1	*	*	*	*
Asian	12	5	5	1	*	*	*	*	*	*	1	*
Some Others	12	7	4	1	*	*	*	*	*	*	1	*
Hispanic	26	10	13	1	*	2	*	*	*	*	*	*
Refused	6	5	1	*	*	*	*	*	*	*	*	*
<b>Hispanic</b>												
No	600	430	127	19	9	2	2	1	1	1	3	5
Yes	40	21	16	1	*	*	*	*	*	*	*	*
DK	6	5	1	*	*	*	*	*	*	*	*	*
Refused	3	3	*	*	*	*	*	*	*	*	*	*
<b>Employment</b>												
*	1	1	*	*	*	*	*	*	*	*	*	*
Full Time	283	183	76	12	5	2	1	1	1	1	1	1
Part Time	76	56	17	1	1	1	*	*	*	*	*	*
Not Employed	287	217	51	7	3	3	*	*	*	*	2	4
Refused	2	2	*	*	*	*	*	*	*	*	*	*
<b>Education</b>												
*	4	4	*	*	*	*	*	*	*	*	*	*
< High School	96	66	19	3	2	2	*	*	*	*	1	3
High School Graduate	235	167	54	8	2	*	1	*	*	*	*	2
< College	163	112	38	6	2	2	1	*	*	1	1	*
College Graduate	102	68	28	3	2	*	*	*	1	*	*	*
Post Graduate	49	42	5	*	1	*	*	*	*	*	1	*
<b>Census Region</b>												
Northeast	137	100	25	3	4	1	1	*	*	1	*	2
Midwest	151	116	29	4	1	*	*	*	1	*	*	*
South	255	164	70	9	2	3	1	1	*	*	2	3
West	106	79	20	4	2	*	*	*	*	*	1	*
<b>Day of Week</b>												
Weekday	415	299	89	10	4	2	2	1	1	1	2	4
Weekend	234	160	55	10	5	2	*	*	*	*	1	1
<b>Season</b>												
Winter	178	124	37	10	1	3	*	*	*	*	1	2
Spring	160	126	27	4	1	*	*	1	*	*	*	1
Summer	174	112	49	4	3	1	1	*	1	*	2	1
Fall	137	97	31	2	4	*	1	*	*	1	*	1
<b>Asthma</b>												
No	596	424	129	19	7	4	2	1	1	1	3	5
Yes	52	34	15	1	2	*	*	*	*	*	*	*
DK	1	1	*	*	*	*	*	*	*	*	*	*
<b>Angina</b>												
No	620	435	141	19	9	4	2	1	1	1	3	4
Yes	26	22	2	1	*	*	*	*	*	*	*	1
DK	3	2	1	*	*	*	*	*	*	*	*	*
<b>Bronchitis/Emphysema</b>												
No	610	429	137	20	9	4	2	1	1	1	2	4
Yes	36	27	7	*	*	*	*	*	*	*	1	1
DK	3	3	*	*	*	*	*	*	*	*	*	*

NOTE: \* Signifies missing data; Dk= respondents answered don't know; N = sample size; Refused = respondents refused to answer.  
Source: Tsang and Klepeis, 1996



Table 15-25. Total Time Spent Taking or Giving a Bath by the Number of Respondents

	Total N	Minutes/Bath							
		*.*	0-10	10-20	20-30	30-40	40-50	50-60	61-61
<b>Overall</b>	649	18	153	237	128	27	29	36	21
<b>Gender</b>									
Male	159	4	48	59	23	8	4	7	6
Female	490	14	105	178	105	19	25	29	15
<b>Age (years)</b>									
*	9	2	2	4	1	*	*	*	*
18-64	491	6	105	174	111	22	24	31	18
> 64	149	10	46	59	16	5	5	5	3
<b>Race</b>									
White	487	11	124	185	97	16	19	24	11
Black	106	4	16	35	19	8	9	9	6
Asian	12	*	2	6	3	1	*	*	*
Some Others	12	*	2	6	3	1	*	*	1
Hispanic	26	1	8	6	3	1	1	3	3
Refused	6	2	1	2	1	*	*	*	*
<b>Hispanic</b>									
No	600	16	136	224	120	26	27	33	18
Yes	40	1	15	10	6	1	1	3	3
DK	6	*	1	2	2	*	1	*	*
Refused	3	1	1	1	*	*	*	*	*
<b>Employment</b>									
*	1	*	*	*	1	*	*	*	*
Full Time	283	4	58	107	64	12	12	19	7
Part Time	76	1	26	26	15	5	1	2	*
Not Employed	287	12	69	104	48	10	16	15	13
Refused	2	1	*	*	*	*	*	*	1
<b>Education</b>									
*	4	1	*	2	1	*	*	*	*
< High School	96	7	15	35	16	3	6	7	7
High School Graduate	235	6	57	85	51	13	5	11	7
< College	163	4	45	53	32	4	11	8	6
College Graduate	102	*	18	44	20	5	5	9	1
Post Graduate	49	*	18	18	8	2	2	1	*
<b>Census Region</b>									
Northeast	137	5	43	36	31	6	7	6	3
Midwest	151	2	42	67	26	3	3	5	3
South	255	9	42	87	55	16	14	21	11
West	106	2	26	47	16	2	5	4	4
<b>Day of Week</b>									
Weekday	415	12	90	161	84	11	23	23	11
Weekend	234	6	63	76	44	16	6	13	10
<b>Season</b>									
Winter	178	5	44	63	33	9	11	9	4
Spring	160	6	39	60	27	9	7	6	6
Summer	174	3	43	62	34	7	4	14	7
Fall	137	4	27	52	34	2	7	7	4
<b>Asthma</b>									
No	596	16	144	218	114	26	28	33	17
Yes	52	1	9	19	14	1	1	3	4
DK	1	1	*	*	*	*	*	*	*
<b>Angina</b>									
No	620	14	147	226	124	25	28	35	21
Yes	26	3	6	10	3	2	1	1	*
DK	3	1	*	1	1	*	*	*	*
<b>Bronchitis/Emphysema</b>									
No	610	15	150	218	119	26	26	35	21
Yes	36	2	3	17	9	1	3	1	*
DK	3	1	*	2	*	*	*	*	*

NOTE: \* Signifies missing data. Dk= respondents answered don't know. Refused = respondents refused to answer. N = doer sample size in a specified range of number of minutes spent. A value of 61 for number of minutes signifies that more than 60 minutes were spent. Source: Tsang and Klepeis,1996



Table 15-26. Number of Minutes Spent Giving and Taking the Bath(s) (minutes/bath)

Category	Population Group	N	Percentiles											
			1	2	5	10	25	50	75	90	95	98	99	100
Overall		631	2	5	5	10	15	20	30	45	60	61	61	61
Gender	Male	155	1	4	5	6	10	15	30	45	60	61	61	61
Gender	Female	476	3	5	5	10	15	20	30	45	60	61	61	61
Age (years)	18-64	485	2	5	5	10	15	20	30	60	60	61	61	61
Age (years)	> 64	139	3	5	5	5	10	15	20	40	60	61	61	61
Race	White	476	1	4	5	10	10	20	30	45	60	61	61	61
Race	Black	102	5	5	9	10	15	22.5	40	60	61	61	61	61
Race	Asian	12	10	10	10	10	15	20	27.5	30	40	40	40	40
Race	Some Others	12	5	5	5	10	15	27.5	30	40	61	61	61	61
Race	Hispanic	25	2	2	5	5	10	20	45	61	61	61	61	61
Hispanic	No	584	2	5	5	10	15	20	30	45	60	61	61	61
Hispanic	Yes	39	2	2	5	5	10	20	30	60	61	61	61	61
Employment	Full Time	279	1	4	5	10	15	20	30	45	60	61	61	61
Employment	Part Time	75	3	4	5	10	10	20	30	35	40	60	60	60
Employment	Not Employed	275	2	5	5	10	10	20	30	60	60	61	61	61
Education	< High School	89	1	5	10	10	15	20	35	60	61	61	61	61
Education	High School Graduate	229	5	5	5	10	12	20	30	45	60	61	61	61
Education	< College	159	1	2	5	6	10	20	30	45	60	61	61	61
Education	College Graduate	102	5	5	8	10	15	20	30	45	60	60	60	61
Education	Post Graduate	49	1	1	5	5	10	15	25	40	45	60	60	60
Census Region	Northeast	132	1	5	5	6	10	15	30	45	60	61	61	61
Census Region	Midwest	149	2	4	5	7	10	20	30	30	60	61	61	61
Census Region	South	246	3	5	10	10	15	20	35	60	60	61	61	61
Census Region	West	104	5	5	5	10	11	20	30	45	60	61	61	61
Day of Week	Weekday	403	2	5	5	10	15	20	30	45	60	61	61	61
Day of Week	Weekend	228	4	5	5	10	10	20	30	60	60	61	61	61
Season	Winter	173	2	5	5	10	10	20	30	45	60	61	61	61
Season	Spring	154	1	3	5	10	10	20	30	45	60	61	61	61
Season	Summer	171	5	5	5	10	10	20	30	60	60	61	61	61
Season	Fall	133	4	5	8	10	15	20	30	45	60	61	61	61
Asthma	No	580	2	5	5	10	12	20	30	45	60	61	61	61
Asthma	Yes	51	4	5	5	10	15	20	30	60	61	61	61	61
Angina	No	606	2	5	5	10	15	20	30	45	60	61	61	61
Angina	Yes	23	5	5	5	5	10	15	30	40	45	60	60	60
Bronchitis/Emphysema	No	595	2	5	5	10	10	20	30	45	60	61	61	61
Bronchitis/Emphysema	Yes	34	5	5	8	15	15	20	30	45	45	60	60	60

NOTE: N = doer sample size. Percentiles are the percentage of doers below or equal to a given number of minutes. A value of 61 for number of minutes signifies that more than 60 minutes were spent.  
Source: Tsang and Klepeis, 1996



Table 15-27. Time Spent in the Bathroom Immediately After the Bath(s) by the Number of Respondents

	Total N	Minutes/Bath								
		*-*	0-0	0-10	10-20	20-30	30-40	40-50	50-60	61-61
<b>Overall</b>	649	25	85	422	74	23	7	6	5	2
<b>Gender</b>										
Male	159	6	18	118	11	4	1	1	*	*
Female	490	19	67	304	63	19	6	5	5	2
<b>Age (years)</b>										
18-64	9	2	2	4	1	*	*	*	*	*
> 64	491	7	71	336	50	14	4	5	2	2
<b>Race</b>										
White	149	16	12	82	23	9	3	1	3	*
Black	487	22	59	319	58	15	4	4	5	1
Asian	106	2	14	67	13	5	3	2	*	*
Some Others	12	*	2	9	*	*	*	*	*	*
Hispanic	12	*	5	6	*	*	*	*	*	1
Refused	26	*	4	18	*	3	*	*	*	1
<b>Hispanic</b>										
No	6	1	1	3	1	*	*	*	*	*
Yes	600	25	76	390	71	20	7	6	4	1
DK	40	*	7	28	1	3	*	*	1	1
Refused	6	*	1	1	1	*	*	*	1	*
<b>Employment</b>										
Full Time	1	*	*	1	*	*	*	*	*	*
Part Time	283	6	35	203	30	7	1	1	*	*
Not Employed	76	1	9	54	8	2	2	*	*	*
Refused	287	18	41	164	35	14	4	4	5	2
<b>Education</b>										
< High School	4	1	*	2	1	*	*	*	*	*
High School Graduate	96	10	35	51	12	7	1	3	2	2
< College	235	6	11	158	22	7	3	3	1	*
College Graduate	163	4	17	113	18	4	3	2	2	*
Post Graduate	102	2	14	66	15	4	*	1	*	*
Refused	49	2	8	32	6	1	*	*	*	*
<b>Census Region</b>										
Northeast	137	8	13	91	16	8	*	*	1	*
Midwest	151	5	20	100	18	3	2	1	2	*
South	255	9	31	164	30	9	5	4	1	2
West	106	3	21	67	10	3	*	1	1	*
<b>Day of Week</b>										
Weekday	415	17	53	280	40	16	2	4	2	1
Weekend	234	8	32	142	34	7	5	2	3	1
<b>Season</b>										
Winter	178	3	14	122	24	7	3	1	2	2
Spring	160	8	21	96	20	8	4	2	1	*
Summer	174	9	31	110	16	6	*	2	*	*
Fall	137	5	19	94	14	2	*	1	2	*
<b>Asthma</b>										
No	596	24	75	388	69	21	7	5	5	2
Yes	52	1	10	34	4	2	*	1	*	*
DK	1	*	*	*	1	*	*	*	*	*
<b>Angina</b>										
No	620	23	82	405	70	22	6	6	4	2
Yes	26	2	2	17	3	1	*	*	1	*
DK	3	*	1	*	1	*	1	*	*	*
<b>Bronchitis/Emphysema</b>										
No	610	22	78	400	71	21	6	5	5	2
Yes	36	3	6	21	2	2	1	1	*	*
DK	3	*	1	1	1	*	*	*	*	*

Note: \* Signifies missing data. Dk= respondents answered don't know. Refused = respondents refused to answer. N = doer sample size in specified range of number of minutes spent. A value of 61 for number of minutes signifies that more than 60 minutes were spent.

Source: Tsang and Klepeis,1996



Table 15-28. Number of Minutes Spent in the Bathroom Immediately After the Bath(s) (minutes/bath)

Category	Population Group	N	Percentiles											
			1	2	5	10	25	50	75	90	95	98	99	100
Overall		624	0	0	0	0	2	5	10	20	30	45	55	61
Gender	Male	153	0	0	0	0	2	5	10	12	20	30	35	45
Gender	Female	471	0	0	0	0	2	5	10	20	30	45	60	61
Age (years)	18-64	484	0	0	0	0	2	5	10	15	25	40	50	61
Age (years)	> 64	133	0	0	0	1	5	10	15	30	35	55	60	60
Race	White	465	0	0	0	0	2	5	10	18	30	45	58	61
Race	Black	104	0	0	0	0	2	5	10	20	30	40	45	45
Race	Asian	12	0	0	0	0	2	5	7.5	10	20	20	20	20
Race	Some Others	12	0	0	0	0	0	3	7.5	10	15	15	15	15
Race	Hispanic	26	0	0	0	0	1	5	10	25	25	61	61	61
Hispanic	No	575	0	0	0	0	2	5	10	20	30	40	50	61
Hispanic	Yes	40	0	0	0	0	1	5	10	22.5	25	61	61	61
Employment	Full Time	277	0	0	0	0	2	5	10	15	20	30	30	45
Employment	Part Time	75	0	0	0	0	3	5	10	15	25	35	40	40
Employment	Not Employed	269	0	0	0	0	2	5	10	25	35	58	60	61
Education	< High School	86	0	0	0	0	5	10	15	30	35	61	61	61
Education	High School Graduate	229	0	0	0	0	2	5	10	15	30	40	45	58
Education	< College	159	0	0	0	0	2	5	10	15	30	45	60	60
Education	College Graduate	100	0	0	0	0	1.5	5	10	19	25	30	37.5	45
Education	Post Graduate	47	0	0	0	0	1	5	10	15	20	30	30	30
Census Region	Northeast	129	0	0	0	0	2	5	10	20	30	30	30	60
Census Region	Midwest	146	0	0	0	0	2	5	10	15	25	50	60	60
Census Region	South	246	0	0	0	0	3	5	10	20	30	45	55	61
Census Region	West	103	0	0	0	0	1	5	10	20	20	30	45	58
Day of Week	Weekday	398	0	0	0	0	2	5	10	18	30	40	50	61
Day of Week	Weekend	226	0	0	0	0	3	5	10	20	30	45	60	61
Season	Winter	175	0	0	0	1	3	5	10	20	30	58	61	61
Season	Spring	152	0	0	0	0	2	5	10	20	30	40	45	60
Season	Summer	165	0	0	0	0	2	5	10	15	20	30	45	50
Season	Fall	132	0	0	0	0	2	5	10	15	20	45	55	60
Asthma	No	572	0	0	0	0	2	5	10	20	30	45	58	61
Asthma	Yes	51	0	0	0	0	1	5	10	15	30	30	45	45
Angina	No	597	0	0	0	0	2	5	10	20	30	45	58	61
Angina	Yes	24	0	0	0	1	5	5	10	15	30	55	55	55
Bronchitis/Emphysema	No	588	0	0	0	0	2	5	10	20	30	45	58	61
Bronchitis/Emphysema	Yes	33	0	0	0	0	2	5	10	30	40	45	45	45

NOTE: N = doer sample size. Percentiles are the percentage of doers below or equal to a given number of minutes. A value of 61 for number of minutes signifies that more than 60 minutes were spent.  
Source: Tsang and Klepeis, 1996



Table 15-29. Total Time Spent Altogether in the Shower or Bathtub by the Number of Respondents

	Total N	Minutes/Bath													
		*-*	0-0	0-10	10-20	20-30	30-40	40-50	50-60	70-80	80-90	90-100	100-110	110-120	121-121
<b>Overall</b>	4290	38	5	1903	1577	548	46	65	67	3	6	2	1	21	8
<b>Gender</b>															
Male	1934	8	1	872	735	234	19	24	24	1	1	1	1	10	3
Female	2355	30	4	1031	841	314	27	41	43	2	5	1	1	11	5
Refused	1	*	*	*	1	*	*	*	*	*	*	*	*	*	*
<b>Age (years)</b>															
1-4	86	5	1	26	36	12	*	1	4	*	*	*	*	*	1
5-11	198	2	*	35	84	50	2	13	7	1	1	1	*	4	1
12-17	265	2	*	64	107	66	7	7	7	2	2	1	1	2	1
18-64	250	*	*	78	96	46	2	5	8	*	*	*	*	1	1
> 64	2919	15	1	1429	1051	303	32	31	35	*	3	*	*	13	6
Refused	583	16	3	271	203	71	4	8	6	*	*	*	*	1	*
<b>Race</b>															
White	3452	27	4	1616	1248	401	35	44	50	1	3	*	1	16	6
Black	453	7	1	141	177	89	7	11	11	2	*	1	*	4	2
Asian	74	*	*	33	31	7	*	1	1	*	1	*	*	*	*
Some Others	78	*	*	24	28	19	2	3	2	*	*	*	*	*	*
Hispanic	180	2	*	63	79	24	2	4	2	*	2	1	*	1	*
Refused	53	2	*	26	14	8	*	2	1	*	*	*	*	*	*
<b>Hispanic</b>															
No	3892	31	4	1744	1423	496	41	56	62	3	4	1	1	18	8
Yes	333	5	1	128	136	40	5	8	5	*	*	*	*	1	*
DK	21	1	*	7	4	4	*	*	*	*	*	*	*	*	*
Refused	44	1	*	24	10	8	*	1	*	*	*	*	*	*	*
<b>Employment</b>															
* Full Time	692	2	*	172	284	162	9	24	22	3	3	2	1	7	1
* Part Time	1985	11	2	1002	707	190	20	20	18	*	*	*	*	12	3
* Not Employed	400	5	1	190	147	44	4	4	5	*	*	*	*	*	*
* Refused	1181	20	2	524	429	146	13	17	22	*	3	*	*	1	4
* Refused	32	*	*	15	10	6	*	*	*	*	*	*	*	1	*
<b>Education</b>															
* < High School	775	6	*	200	317	175	10	26	24	3	3	2	1	7	1
* High School Graduate	386	10	2	132	147	66	7	8	10	*	1	*	*	1	2
* < College	1254	12	1	574	476	138	14	14	18	*	*	*	*	4	3
* College Graduate	864	2	*	414	331	93	6	7	8	*	1	*	*	2	*
* College Graduate	588	4	1	308	168	53	7	7	4	*	1	*	*	5	*
* Post Graduate	453	4	1	275	138	23	2	3	3	*	*	*	*	2	2
<b>Census Region</b>															
* Northeast	927	7	*	436	328	106	11	14	12	1	2	1	*	6	3
* Midwest	956	9	3	440	343	126	5	15	10	*	2	1	*	2	*
* South	1513	16	2	601	588	208	22	25	35	2	1	*	1	8	4
* West	894	6	*	426	318	108	8	11	10	*	1	*	*	5	1
<b>Day of Week</b>															
* Weekday	2881	23	3	1346	1038	336	30	40	39	1	1	2	1	16	5
* Weekend	1409	15	2	557	539	212	16	25	28	2	5	*	*	5	3
<b>Season</b>															
* Winter	1124	8	1	504	417	137	14	13	19	1	*	*	*	7	3
* Spring	1145	15	3	499	417	149	9	22	17	1	*	1	*	7	2
* Summer	1165	11	1	495	420	176	14	19	19	1	3	1	*	5	1
* Fall	856	4	*	405	323	86	9	11	12	*	1	*	1	2	2
<b>Asthma</b>															
* No	3946	35	5	1767	1445	502	38	53	65	3	5	2	1	19	6
* Yes	327	2	*	128	128	43	8	11	2	*	1	*	*	2	2
* DK	17	1	*	8	4	3	*	1	*	*	*	*	*	*	*
<b>Angina</b>															
* No	4151	34	5	1839	1529	530	45	62	66	3	6	2	1	21	8
* Yes	114	3	*	52	41	14	1	2	1	*	*	*	*	*	*
* DK	25	1	*	12	7	4	*	1	*	*	*	*	*	*	*
<b>Bronchitis/Emphysema</b>															
* No	4059	34	3	1803	1502	517	42	58	63	3	5	2	1	19	7
* Yes	207	2	2	86	71	28	4	6	4	*	1	*	*	2	1
* DK	24	2	*	14	4	3	*	1	*	*	*	*	*	*	*

Note: \* Signifies missing data. DK = respondents answered "don't know". Refused = respondents refused to answer. N = doer sample size in specified range of number of minutes spent. A value of "121" for number of minutes signifies that more than 120 minutes were spent.  
Source: Tsang and Klepeis, 1996



Table 15-30. Total Number of Minutes Spent Altogether in the Shower or Bathtub (minutes/bath)

Category	Population Group	N	Percentiles											
			1	2	5	10	25	50	75	90	95	98	99	100
Overall		4252	3	4	5	5	10	15	20	30	35	60	60	121
Gender	Male	1926	3	4	5	5	10	15	20	30	30	60	60	121
Gender	Female	2325	3	4	5	5	10	15	20	30	40	60	75	121
Age (years)	1-4	198	1	5	5	10	15	20	30	45	60	120	120	120
Age (years)	5-11	263	4	5	5	10	13	20	30	30	60	90	120	121
Age (years)	12-17	239	4	4	5	7	10	15	30	30	45	60	60	120
Age (years)	18-64	2904	3	4	5	5	10	13.5	20	30	30	50	60	121
Age (years)	> 64	567	2	3	5	5	10	15	20	30	30	45	60	120
Race	White	3425	3	4	5	5	10	15	20	30	30	60	60	121
Race	Black	446	4	4	5	6	10	15	25	30	45	75	120	121
Race	Asian	74	5	5	5	7	10	15	15	30	30	60	90	90
Race	Some Others	78	5	5	5	7	10	15	30	30	45	60	60	60
Race	Hispanic	178	1	3	5	7	10	15	20	30	45	90	100	120
Hispanic	No	3861	3	4	5	5	10	15	20	30	35	60	60	121
Hispanic	Yes	328	1	3	5	5	10	15	20	30	45	60	90	120
Employment	Full Time	1974	3	4	5	5	10	10	20	30	30	45	60	121
Employment	Part Time	395	3	3	5	5	10	15	20	30	30	45	60	60
Employment	Not Employed	1161	2	3	5	5	10	15	20	30	35	60	60	121
Education	< High School	376	1	4	5	5	10	15	25	30	45	60	90	121
Education	High School Graduate	1242	3	4	5	5	10	15	20	30	30	60	60	121
Education	< College	862	3	4	5	5	10	15	20	30	30	45	60	120
Education	College Graduate	554	3	3	5	5	10	10	15	30	30	45	90	120
Education	Post Graduate	449	3	4	5	5	8	10	15	20	30	45	60	121
Census Region	Northeast	920	4	4	5	5	10	15	20	30	35	60	100	121
Census Region	Midwest	947	3	4	5	5	10	15	20	30	30	45	60	120
Census Region	South	1497	3	4	5	5	10	15	20	30	45	60	75	121
Census Region	West	888	3	3	5	5	10	15	20	30	30	45	60	121
Day of Week	Weekday	2858	3	4	5	5	10	15	20	30	30	60	60	121
Day of Week	Weekend	1394	3	4	5	5	10	15	20	30	40	60	75	121
Season	Winter	1116	3	4	5	5	10	15	20	30	35	60	60	121
Season	Spring	1130	3	4	5	5	10	15	20	30	40	60	90	121
Season	Summer	1154	3	4	5	5	10	15	20	30	40	60	60	121
Season	Fall	852	3	5	5	5	10	15	20	30	30	60	60	121
Asthma	No	3911	3	4	5	5	10	15	20	30	30	60	60	121
Asthma	Yes	325	3	4	5	5	10	15	20	30	45	60	120	121
Angina	No	4117	3	4	5	5	10	15	20	30	35	60	60	121
Angina	Yes	111	3	4	5	5	10	15	20	30	30	45	45	60
Bronchitis/Emphysema	No	4025	3	4	5	5	10	15	20	30	30	60	60	121
Bronchitis/Emphysema	Yes	205	1	3	5	5	10	15	20	30	45	60	120	121

Note: A value of "121" for number of minutes signifies that more than 120 minutes were spent. N = doer sample size. Percentiles are the percentage of doers below or equal to a given number of minutes.  
 Source: Tsang and Klepeis, 1996.



Table 15-31. Time Spent in the Bathroom Immediately Following a Shower or Bath by the Number of Respondents

	Total N	Minutes/Shower or Bath											
		*_*	0-0	0-10	10-20	20-30	30-40	40-50	50-60	70-80	80-90	110-120	121-121
<b>Overall</b>	4290	108	348	2770	713	250	20	32	35	1	2	7	4
<b>Gender</b>													
Male	1934	37	138	1357	312	67	5	8	6	*	*	1	3
Female	2355	71	210	1413	400	183	15	24	29	1	2	6	1
Refused	1	*	*	*	1	*	*	*	*	*	*	*	*
<b>Age (years)</b>													
*_*	86	12	8	38	19	6	*	1	1	*	*	*	1
1-4	198	2	59	123	12	12	*	1	*	*	*	*	*
5-11	265	5	33	198	23	3	1	1	2	*	*	1	*
12-17	239	1	17	165	34	16	3	3	1	*	*	1	*
18-64	2919	53	184	1901	517	189	14	25	26	1	1	5	3
> 64	583	35	47	345	108	36	3	2	5	*	*	1	*
<b>Race</b>													
White	3452	80	271	2235	590	194	15	29	24	1	2	7	4
Black	453	15	49	276	63	35	4	2	9	*	*	*	*
Asian	74	2	8	48	12	4	1	1	1	*	*	*	*
Some Others	78	2	7	46	19	3	*	*	1	*	*	*	*
Hispanic	180	4	8	134	21	12	*	*	1	*	*	*	*
Refused	53	7	5	31	8	2	*	*	*	*	*	*	*
<b>Hispanic</b>													
No	3892	95	316	2504	655	227	19	32	32	1	1	6	4
Yes	333	8	28	227	46	21	1	*	2	*	*	1	*
DK	21	*	1	10	5	2	*	*	1	*	*	1	*
Refused	44	5	3	29	7	*	*	*	*	*	*	*	*
<b>Employment</b>													
*_*	692	8	111	479	66	17	3	4	3	*	*	1	*
Full Time	1985	36	122	1302	357	120	10	16	14	1	1	3	3
Part Time	400	8	23	256	71	32	2	5	2	1	1	2	1
Not Employed	1181	52	93	712	214	79	5	7	16	*	1	1	1
Refused	32	4	*	21	5	2	*	*	*	*	*	*	*
<b>Education</b>													
*_*	775	14	114	531	82	20	3	7	3	*	*	1	*
< High School	386	28	30	220	65	30	2	1	5	*	2	1	2
High School Graduate	1254	34	89	799	204	90	8	12	10	1	*	4	1
< College	864	17	59	568	158	46	4	2	9	*	*	*	1
College Graduate	558	8	27	362	115	31	2	8	5	*	*	*	*
Post Graduate	453	7	29	290	89	31	1	2	3	*	*	1	*
<b>Census Region</b>													
Northeast	927	20	69	614	161	49	3	2	6	*	*	1	2
Midwest	956	27	86	600	155	57	5	13	11	*	*	1	1
South	1513	41	119	971	255	93	8	7	10	1	2	5	1
West	894	20	74	585	142	51	4	10	8	*	*	*	*
<b>Day of Week</b>													
Weekday	2881	79	224	1889	474	153	15	19	19	1	1	5	2
Weekend	1409	29	124	881	239	97	5	13	16	*	*	*	2
<b>Season</b>													
Winter	1124	34	77	726	193	65	7	8	9	*	1	3	1
Spring	1145	26	99	756	167	70	4	12	10	*	*	1	*
Summer	1165	36	112	740	184	66	6	9	8	1	1	2	*
Fall	856	12	60	548	169	49	3	3	8	*	*	1	3
<b>Asthma</b>													
No	3946	101	306	2540	673	236	18	30	32	1	1	6	2
Yes	327	5	41	219	37	14	*	2	*	*	1	1	2
DK	17	2	1	11	3	*	*	*	*	*	*	*	*
<b>Angina</b>													
No	4151	99	333	2687	691	241	20	32	34	1	2	7	4
Yes	114	6	13	68	17	9	*	*	1	*	*	*	*
DK	25	3	2	15	5	*	*	*	*	*	*	*	*
<b>Bronchitis/Emphysema</b>													
No	4059	98	325	2623	684	236	19	31	32	1	1	6	3
Yes	207	6	22	133	24	14	*	1	3	*	*	1	1
DK	24	4	1	14	5	*	*	*	*	*	*	*	*

Note: \* Signifies missing data. A value of "121" for number of minutes signifies that more than 120 minutes were spent. DK= respondents answered "don't know". Refused = respondents refused to answer. N = doer sample size in a specified range or number of minutes spent.  
Source: Tsang and Klepeis.





Table 15-32. Number of Minutes Spent in the Bathroom Immediately Following a Shower or Bath (minutes/bath)														
Category	Population Group	N	Percentiles											
			1	2	5	10	25	50	75	90	95	98	99	100
Overall		4182	0	0	0	1	4	5	15	20	30	40	60	121
Gender	Male	1897	0	0	0	1	3	5	10	15	20	30	40	121
Gender	Female	2284	0	0	0	1	5	10	15	30	30	45	60	121
Age (years)	1-4	196	0	0	0	0	0	2	5	10	15	20	35	45
Age (years)	5-11	260	0	0	0	0	2	5	10	15	15	30	35	120
Age (years)	12-17	238	0	0	0	2	5	5	10	20	30	45	45	60
Age (years)	18-64	2866	0	0	0	1	5	10	15	20	30	45	60	121
Age (years)	> 64	548	0	0	0	1	4	10	15	20	30	40	60	120
Race	White	3372	0	0	0	1	4	5	15	20	30	40	60	121
Race	Black	438	0	0	0	0	4	6	15	30	30	60	60	60
Race	Asian	74	0	0	0	0	2	5	10	20	30	35	45	45
Race	Some Others	76	0	0	0	1	5	10	15	20	25	30	60	60
Race	Hispanic	176	0	0	1	1	3	5	10	20	30	30	30	60
Hispanic	No	3797	0	0	0	1	4	5	15	20	30	45	60	121
Hispanic	Yes	325	0	0	0	1	3	5	10	20	30	30	30	60
Employment	Full Time	1949	0	0	0	1	5	10	15	20	30	40	60	121
Employment	Part Time	392	0	0	0	2	5	10	15	25	30	45	60	120
Employment	Not Employed	1129	0	0	0	1	5	10	15	20	30	45	60	121
Education	< High School	358	0	0	0	1	5	10	15	30	30	60	90	121
Education	High School Graduate	1220	0	0	0	1	5	10	15	25	30	45	60	121
Education	< College	847	0	0	0	1	5	10	15	20	30	30	60	121
Education	College Graduate	550	0	0	1	2	5	10	15	20	30	45	45	60
Education	Post Graduate	446	0	0	0	1	5	8	15	20	30	30	50	120
Census Region	Northeast	907	0	0	0	1	5	5	10	20	30	30	45	121
Census Region	Midwest	929	0	0	0	1	5	5	15	20	30	45	60	121
Census Region	South	1472	0	0	0	1	3.5	5	15	20	30	40	60	121
Census Region	West	874	0	0	0	1	3	5	10	20	30	45	45	60
Day of Week	Weekday	2802	0	0	0	1	4	5	10	20	30	35	50	121
Day of Week	Weekend	1380	0	0	0	1	4	8	15	20	30	45	60	121
Season	Winter	1090	0	0	0	1	5	7	15	20	30	45	60	121
Season	Spring	1119	0	0	0	1	3	5	10	20	30	45	50	120
Season	Summer	1129	0	0	0	1	3	5	10	20	30	40	52	120
Season	Fall	844	0	0	0	1	5	8	15	20	30	35	60	121
Asthma	No	3845	0	0	0	1	4	5	15	20	30	40	60	121
Asthma	Yes	322	0	0	0	0	3	5	10	20	30	60	90	121
Angina	No	4052	0	0	0	1	4	5	15	20	30	40	60	121
Angina	Yes	108	0	0	0	0	4.5	5.5	12.5	20	30	30	30	60
Bronchitis/emphysema	No	3961	0	0	0	1	4	5	15	20	30	40	60	121
Bronchitis/emphysema	Yes	201	0	0	0	0	4	10	10	30	30	60	88	121

Note: A value of "121" for number of minutes signifies that more than 120 minutes were spent. N = doer sample size. Percentiles are the percentage of doers below or equal to a given number of minutes.  
Source: Tsang and Klepeis, 1996.



Table 15-33. Range of Number of Times Washing the Hands at Specified Daily Frequencies by the Number of Respondents										
	Total N	Number of Times/Day								
		*-*	0-0	1-2	3-5	6-9	10-19	20-29	30+	DK
<b>Overall</b>	4663	38	34	311	1692	1106	892	223	178	189
<b>Gender</b>										
Male	2163	16	19	218	975	487	286	59	49	54
Female	2498	22	15	92	716	619	606	164	129	135
Refused	2	*	*	1	1	*	*	*	*	*
<b>Age (years)</b>										
*	84	8	*	1	25	15	11	4	5	15
1-4	263	*	15	62	125	35	11	2	3	10
5-11	348	1	5	61	191	48	4	4	2	15
12-17	326	3	6	46	159	64	30	7	2	9
18-64	2972	18	7	131	1029	760	640	168	143	76
> 64	670	8	1	10	163	184	179	38	23	64
<b>Race</b>										
White	3774	21	28	251	1377	902	740	181	140	134
Black	463	6	2	30	149	120	85	19	23	29
Asian	77	1	*	5	29	19	12	4	1	6
Some Others	96	*	1	10	39	16	15	8	5	6
Hispanic	193	1	3	14	78	42	31	10	5	9
Refused	60	9	*	1	20	7	9	1	4	9
<b>Hispanic</b>										
No	4244	27	29	276	1536	1022	823	205	164	162
Yes	347	2	5	33	130	76	57	17	10	17
DK	26	*	*	1	12	4	5	1	1	2
Refused	46	9	*	1	14	4	7	*	3	8
<b>Employment</b>										
*	926	4	26	165	471	145	61	13	7	34
Full Time	2017	12	4	96	707	525	406	116	103	48
Part Time	379	*	*	13	142	101	86	10	15	12
Not Employed	1309	18	4	36	365	327	334	83	52	90
Refused	32	4	*	1	7	8	5	1	1	5
<b>Education</b>										
*	1021	13	26	174	507	158	74	13	12	44
< High School	399	2	8	8	120	96	88	26	24	35
High School Graduate	1253	12	4	56	391	318	298	70	47	57
< College	895	2	3	28	284	246	197	59	48	28
College Graduate	650	6	*	23	238	174	139	28	27	15
Post Graduate	445	3	1	22	152	114	96	27	20	10
<b>Census Region</b>										
Northeast	1048	9	6	68	404	243	195	55	38	30
Midwest	1036	5	7	68	373	251	212	41	38	41
South	1601	14	11	108	559	379	299	79	66	86
West	978	10	10	67	356	253	186	48	36	32
<b>Day of Week</b>										
Weekday	3156	34	22	199	1103	764	599	155	147	133
Weekend	1507	4	12	112	589	342	293	68	31	56
<b>Season</b>										
Winter	1264	6	10	91	507	286	223	55	51	35
Spring	1181	13	9	78	406	283	238	60	44	50
Summer	1275	15	9	78	443	315	232	65	48	70
Fall	943	4	6	64	336	222	199	43	35	34
<b>Asthma</b>										
No	4287	28	32	283	1562	1024	819	207	165	167
Yes	341	1	2	26	126	77	69	16	10	14
DK	35	9	*	2	4	5	4	*	3	8
<b>Angina</b>										
No	4500	28	34	306	1652	1069	851	218	171	171
Yes	125	2	*	3	32	34	36	5	3	10
DK	38	8	*	2	8	3	5	*	4	8
<b>Bronchitis/Emphysema</b>										
No	4424	27	33	302	1627	1040	835	213	172	175
Yes	203	3	1	7	57	61	55	10	3	6
DK	36	8	*	2	8	5	2	*	3	8

Note: \* Signifies missing data. N = doer sample size in a specified range or number of minutes spent. DK= respondents answered "don't know". Refused = respondents refused to answer.  
Source: Tsang and Klepeis.1996



Table 15-34. Number of Minutes Spent (at home) Working or Being Near Food While Fried, Grilled, or Barbequed (minutes/day)

Category	Population Group	N	Percentiles											
			1	2	5	10	25	50	75	90	95	98	99	100
Overall		1055	0	1	2	5	10	20	30	105	121	121	121	121
Gender	Male	485	0	1	2	5	10	20	30	90	121	121	121	121
Gender	Female	570	0	0	2	5	10	20	30	120	121	121	121	121
Age (years)	1-4	35	0	0	2	2	5	20	30	45	60	60	60	60
Age (years)	5-11	82	0	0	0	2	5	15	30	60	90	121	121	121
Age (years)	12-17	82	0	0	2	4	10	20	45	60	90	121	121	121
Age (years)	18-64	747	0	2	3	5	10	20	40	120	121	121	121	121
Age (years)	> 64	96	0	1	3	5	10	20	30	60	120	121	121	121
Race	White	848	0	1	2	5	10	20	30	105	121	121	121	121
Race	Black	115	2	2	5	5	10	20	30	61	121	121	121	121
Race	Asian	18	0	0	0	0	5	10	20	121	121	121	121	121
Race	Some Others	16	5	5	5	5	12.5	20	45	121	121	121	121	121
Race	Hispanic	48	0	0	5	5	15	30	60	90	121	121	121	121
Hispanic	No	960	0	1	2	5	10	20	30	90	121	121	121	121
Hispanic	Yes	84	0	1	2	5	10	20	60	121	121	121	121	121
Employment	Full Time	506	1	2	3	5	10	20	45	121	121	121	121	121
Employment	Part Time	95	0	1	2	5	10	15	40	90	121	121	121	121
Employment	Not Employed	252	0	1	3	5	10	20	30	90	121	121	121	121
Education	< High School	96	0	1	2	5	10	22.5	52.5	121	121	121	121	121
Education	High School Graduate	318	0	2	5	5	10	20	30	120	121	121	121	121
Education	< College	208	0	2	3	5	10	20	35	121	121	121	121	121
Education	College Graduate	135	1	1	2	5	10	20	30	90	121	121	121	121
Education	Post Graduate	83	0	2	5	5	10	15	30	60	121	121	121	121
Census Region	Northeast	198	0	2	3	5	10	15	30	90	121	121	121	121
Census Region	Midwest	248	0	0	4	5	10	20	30	121	121	121	121	121
Census Region	South	399	0	1	2	5	10	20	40	90	121	121	121	121
Census Region	West	210	0	0	2	5	7	15	30	60	121	121	121	121
Day of Week	Weekday	662	0	1	3	5	10	20	30	90	121	121	121	121
Day of Week	Weekend	393	0	1	2	5	10	20	30	120	121	121	121	121
Season	Winter	267	0	2	2	5	10	20	30	60	121	121	121	121
Season	Spring	296	0	0	3	5	10	20	45	120	121	121	121	121
Season	Summer	299	0	0	3	5	10	20	30	90	121	121	121	121
Season	Fall	193	0	0	2	5	10	20	30	121	121	121	121	121
Asthma	No	960	0	1	2.5	5	10	20	30	90	121	121	121	121
Asthma	Yes	92	0	0	2	5	15	30	60	121	121	121	121	121
Angina	No	1032	0	1	2	5	10	20	30	95	121	121	121	121
Angina	Yes	19	0	0	0	5	15	30	30	121	121	121	121	121
Bronchitis/Emphysema	No	1005	0	1	2	5	10	20	30	90	121	121	121	121
Bronchitis/Emphysema	Yes	47	0	0	3	5	10	30	60	121	121	121	121	121

Note: A value of "121" for number of minutes signifies that more than 120 minutes were spent. N = doer sample size. Percentiles are the percentage of doers below or equal to a given number of minutes.  
Source: Tsang and Klepeis, 1996.



Table 15-35. Number of Minutes Spent (at home) Working or Being Near Open Flames Including Barbeque Flames (minutes/day)

Category	Population Group	N	Percentiles											
			1	2	5	10	25	50	75	90	95	98	99	100
Overall		479	0	0	1	2	10	20	60	121	121	121	121	121
Gender	Male	252	0	0	1	2	10	20	60	121	121	121	121	121
Gender	Female	227	0	0	2	2	10	20	30	121	121	121	121	121
Age (years)	1-4	14	0	0	0	0	5	10	30	121	121	121	121	121
Age (years)	5-11	29	0	0	0	0	5	15	30	90	121	121	121	121
Age (years)	12-17	28	0	0	1	2	10	22.5	42.5	60	60	90	90	90
Age (years)	18-64	372	0	0	1	3	10	20	60	121	121	121	121	121
Age (years)	:> 64	31	2	2	2	4	5	17	30	120	121	121	121	121
Race	White	407	0	0	1	2	10	20	45	121	121	121	121	121
Race	Black	31	0	0	0	2	5	20	30	60	121	121	121	121
Race	Asian	5	5	5	5	5	20	40	121	121	121	121	121	121
Race	Some Others	8	10	10	10	10	11	22.5	60	121	121	121	121	121
Race	Hispanic	22	2	2	3	5	5	30	60	120	121	121	121	121
Hispanic	No	436	0	0	1	2	10	20	42.5	121	121	121	121	121
Hispanic	Yes	36	2	2	3	5	11	60	90	121	121	121	121	121
Employment	Full Time	262	0	0	1	2	10	20	60	121	121	121	121	121
Employment	Part Time	44	0	0	1	4	5	15	52.5	121	121	121	121	121
Employment	Not Employed	99	0	1	2	3	10	20	40	120	121	121	121	121
Education	< High School	27	2	2	2	3	5	20	60	121	121	121	121	121
Education	High School Graduate	130	0	0	2	3	10	20	60	121	121	121	121	121
Education	< College	92	0	0	1	2	10	30	90	121	121	121	121	121
Education	College Graduate	95	0	1	2	5	10	20	40	121	121	121	121	121
Education	Post Graduate	55	0	0	0	2	10	20	40	121	121	121	121	121
Census Region	Northeast	124	0	0	1	3	10	15	30	121	121	121	121	121
Census Region	Midwest	112	0	0	2	3	10	20	45	121	121	121	121	121
Census Region	South	149	0	0	1	2	5	20	60	121	121	121	121	121
Census Region	West	94	0	0	1	2	10	20	60	121	121	121	121	121
Day of Week	Weekday	284	0	0	1	3	10	15	30	121	121	121	121	121
Day of Week	Weekend	195	0	0	1	2	10	30	60	121	121	121	121	121
Season	Winter	142	0	0	0	2	10	20	60	121	121	121	121	121
Season	Spring	115	0	1	2	3	10	20	60	120	121	121	121	121
Season	Summer	137	0	0	2	3	10	20	45	121	121	121	121	121
Season	Fall	85	1	1	1	3	10	20	40	121	121	121	121	121
Asthma	No	443	0	0	1	2	10	20	45	121	121	121	121	121
Asthma	Yes	35	0	0	3	3	15	30	120	121	121	121	121	121
Angina	No	461	0	0	1	2	10	20	45	121	121	121	121	121
Angina	Yes	15	2	2	2	2	10	15	60	121	121	121	121	121
Bronchitis/Emphysema	No	461	0	0	1	2	10	20	45	121	121	121	121	121
Bronchitis/Emphysema	Yes	16	3	3	3	5	12.5	37.5	106	121	121	121	121	121

Note: A value of "121" for number of minutes signifies that more than 120 minutes were spent. N = doer sample size. Percentiles are the percentage of doers below or equal to a given number of minutes.  
Source: Tsang and Klepeis, 1996.



Table 15-36. Number of Minutes Spent Working or Being Near Excessive Dust in the Air (minutes/day)

Category	Population Group	N	Percentiles											
			1	2	5	10	25	50	75	90	95	98	99	100
Overall		679	0	2	5	7	30	121	121	121	121	121	121	121
Gender	Male	341	1	2	5	8	30	121	121	121	121	121	121	121
Gender	Female	338	0	2	5	5	30	121	121	121	121	121	121	121
Age (years)	1-4	22	0	0	0	2	5	75	121	121	121	121	121	121
Age (years)	5-11	50	0	0.5	2	4	15	75	121	121	121	121	121	121
Age (years)	12-17	52	0	1	2	5	5	20	120	121	121	121	121	121
Age (years)	18-64	513	2	5	5	10	30	121	121	121	121	121	121	121
Age (years)	5:> 64	38	2	2	2	5	35	105.5	121	121	121	121	121	121
Race	White	556	0	2	5	8	30	121	121	121	121	121	121	121
Race	Black	66	1	3	5	5	20	121	121	121	121	121	121	121
Race	Asian	7	20	20	20	20	60	90	121	121	121	121	121	121
Race	Some Others	15	5	5	5	10	60	120	121	121	121	121	121	121
Race	Hispanic	29	3	3	5	7	20	121	121	121	121	121	121	121
Hispanic	No	611	0	2	5	5	30	121	121	121	121	121	121	121
Hispanic	Yes	57	0	3	3	10	30	121	121	121	121	121	121	121
Employment	Full Time	368	2	5	7	15	37.5	121	121	121	121	121	121	121
Employment	Part Time	66	0	2	5	5	20	120	121	121	121	121	121	121
Employment	Not Employed	122	0	2	5	8	30	121	121	121	121	121	121	121
Education	< High School	52	2	5	5	7	35	121	121	121	121	121	121	121
Education	High School Graduate	199	0	0	5	10	30	121	121	121	121	121	121	121
Education	< College	140	5	5	10	20	60	121	121	121	121	121	121	121
Education	College Graduate	82	1	2	5	15	30	121	121	121	121	121	121	121
Education	Post Graduate	76	3	5	5	10	37.5	121	121	121	121	121	121	121
Census Region	Northeast	138	0	0	5	5	20	121	121	121	121	121	121	121
Census Region	Midwest	145	2	2	5	10	30	121	121	121	121	121	121	121
Census Region	South	227	1	2	5	5	30	121	121	121	121	121	121	121
Census Region	West	169	0	3	5	10	30	120	121	121	121	121	121	121
Day of Week	Weekday	471	0	1	5	7	30	121	121	121	121	121	121	121
Day of Week	Weekend	208	2	2	5	5	30	121	121	121	121	121	121	121
Season	Winter	154	0	0	5	5	30	121	121	121	121	121	121	121
Season	Spring	193	0	1	3	5	20	121	121	121	121	121	121	121
Season	Summer	193	2	2	5	10	30	121	121	121	121	121	121	121
Season	Fall	139	3	5	5	10	30	121	121	121	121	121	121	121
Asthma	No	606	0	2	5	5	30	121	121	121	121	121	121	121
Asthma	Yes	73	0	3	5	10	30	121	121	121	121	121	121	121
Angina	No	662	0	2	5	7	30	121	121	121	121	121	121	121
Angina	Yes	15	3	3	3	30	60	121	121	121	121	121	121	121
Bronchitis/Emphysema	No	637	0	2	5	7	30	121	121	121	121	121	121	121
Bronchitis/Emphysema	Yes	41	0	0	5	5	30	121	121	121	121	121	121	121

Note: A value of "121" for number of minutes signifies that more than 120 minutes were spent. N = doer sample size. Percentiles are the percentage of doers below or equal to a given number of minutes.  
 Source: Tsang and Klepeis, 1996.



Table 15-37. Range of the Number of Times an Automobile or Motor Vehicle was Started in a Garage or Carport at Specified Daily Frequencies by the Number of Respondents

	Total N	Times/day					Dk
		1-2	3-5	6-9	10+		
<b>Overall</b>	2009	1321	559	78	17	34	
<b>Gender</b>							
Male	939	588	290	40	7	14	
Female	1070	733	269	38	10	20	
<b>Age(years)</b>							
1-4	20	13	2	1	1	3	
5-11	111	68	39	2	2	*	
12-17	150	93	49	6	*	2	
18-64	145	86	42	12	1	4	
> 64	1287	840	367	50	12	18	
	296	221	60	7	1	7	
<b>Race</b>							
White	1763	1164	486	69	17	27	
Black	110	70	31	4	*	5	
Asian	46	34	10	2	*	*	
Some Others	24	19	5	*	*	*	
Hispanic	55	26	24	3	*	2	
Refused	11	8	3	*	*	*	
<b>Hispanic</b>							
No	1879	1239	519	74	17	30	
Yes	111	68	35	4	*	4	
DK	12	9	3	*	*	*	
Refused	7	5	2	*	*	*	
<b>Employment</b>							
*	398	241	127	20	3	7	
Full Time	919	610	253	35	9	12	
Part Time	149	93	48	4	2	2	
Not Employed	536	372	129	19	3	13	
Refused	7	5	2	*	*	*	
<b>Education</b>							
*	427	262	134	21	4	6	
< High School	84	59	17	2	1	5	
High School Graduate	464	336	107	13	2	6	
< College	440	304	107	20	5	4	
College Graduate	326	201	106	10	2	7	
Post Graduate	268	159	88	12	3	6	
<b>Census Region</b>							
Northeast	289	213	64	8	2	2	
Midwest	541	360	142	29	2	8	
South	702	430	221	27	8	16	
West	477	318	132	14	5	8	
<b>Day of Week</b>							
Weekday	1383	903	386	63	11	20	
Weekend	626	418	173	15	6	14	
<b>Season</b>							
Winter	567	396	136	20	5	10	
Spring	518	336	141	25	5	11	
Summer	525	313	178	18	6	10	
Fall	399	276	104	15	1	3	
<b>Asthma</b>							
No	1861	1228	514	70	17	32	
Yes	146	92	44	8	*	2	
DK	2	1	1	*	*	*	
<b>Angina</b>							
No	1959	1288	545	76	17	33	
Yes	48	33	12	2	*	1	
DK	2	*	2	*	*	*	
<b>Bronchitis/Emphysema</b>							
No	1922	1266	532	74	17	33	
Yes	84	54	25	4	*	1	
DK	3	1	2	*	*	*	

Note: "\*" Signifies missing data; "DK" = respondent answered don't know; Refused - the respondent refused to answer; N = doer sample size.  
Source: Tsang and Klepeis, 1996



Table 15-38. Range of the Number of Times Motor Vehicle Was Started with Garage Door Closed at Specified Daily Frequencies by the Number of Respondents

	Total N	Times/day				
		None	1-2	3-5	6-9	Dk
<b>Overall</b>	2009	1830	99	26	2	52
<b>Gender</b>						
Male	939	860	41	15	*	23
Female	1070	970	58	11	2	29
<b>Age (years)</b>						
* 1-4	20	14	1	*	*	5
1-4	111	99	8	2	*	3
5-11	150	141	6	*	*	3
12-17	145	127	9	4	1	4
18-64	1287	1184	57	18	1	27
> 64	296	265	18	2	*	11
<b>Race</b>						
White	1763	1616	82	22	1	42
Black	110	95	6	2	1	6
Asian	46	41	4	*	*	1
Some Others	24	21	2	*	*	1
Hispanic	55	46	5	2	*	2
Refused	11	11	*	*	*	*
<b>Hispanic</b>						
No	1879	1714	92	23	2	48
Yes	111	97	7	3	*	4
DK	12	12	*	*	*	*
Refused	7	7	*	*	*	*
<b>Employment</b>						
* Full Time	398	360	22	5	1	10
Full Time	919	840	46	13	1	19
Part Time	149	137	6	2	*	4
Not Employed	536	488	24	5	*	19
Refused	7	5	1	1	*	*
<b>Education</b>						
* < High School	427	387	23	6	1	10
< High School	84	74	2	1	*	7
High School Graduate	464	429	24	2	*	9
< College	440	399	24	8	1	8
College Graduate	326	299	12	6	*	9
Post Graduate	268	242	14	3	*	9
<b>Census Region</b>						
Northeast	289	270	10	5	1	3
Midwest	541	500	22	4	1	14
South	702	628	42	8	*	24
West	477	432	25	9	*	11
<b>Day of Week</b>						
Weekday	1383	1269	66	21	*	27
Weekend	626	561	33	5	2	25
<b>Season</b>						
Winter	567	509	32	9	1	16
Spring	518	470	29	3	*	16
Summer	525	476	23	11	*	15
Fall	399	375	15	3	1	5
<b>Asthma</b>						
No	1861	1696	92	23	1	49
Yes	146	132	7	3	1	3
DK	2	2	*	*	*	*
<b>Angina</b>						
No	1959	1785	96	26	2	50
Yes	48	43	3	*	*	2
DK	2	2	*	*	*	*
<b>Bronchitis/Emphysema</b>						
No	1922	1747	96	26	2	51
Yes	84	80	3	*	*	1
DK	3	3	*	*	*	*

Note: "\*" Signifies missing data; "DK" = respondents answered don't know; N = doer sample size; Refused = the respondent refused to answer.  
Source: Tsang and Klepeis, 1996



Table 15-39. Number of Minutes Spent at a Gas Station or Auto Repair Shop (minutes/day)

Category	Population Group	N	Percentiles											
			1	2	5	10	25	50	75	90	95	98	99	100
Overall		967	1	2	3	4	5	6	10	30	90	121	121	121
Gender	Male	552	2	2	3	4	5	7	10	30	120	121	121	121
Gender	Female	414	0	1	2	3	5	5.5	10	15	30	121	121	121
Age (years)	1-4	29	0	0	0	0	5	5	10	20	60	121	121	121
Age (years)	5-11	42	2	2	2	3	5	5	10	15	15	120	120	120
Age (years)	12-17	57	1	3	3	5	5	5	10	20	30	60	121	121
Age (years)	18-64	760	1	2	3	4	5	5.5	10	30	120	121	121	121
Age (years)	> 64	67	0	2	3	4	5	10	15	15	40	120	120	120
Race	White	788	1	2	3	4	5	7.5	10	30	120	121	121	121
Race	Black	95	0	1	2	3	5	5	10	15	15	20	120	120
Race	Asian	13	2	2	2	2	5	5	10	10	10	10	10	10
Race	Some Others	22	5	5	5	5	5	5	12	20	30	30	30	30
Race	Hispanic	42	0	0	3	4	5	10	15	25	30	121	121	121
Hispanic	No	875	1	2	3	4	5	6	10	30	120	121	121	121
Hispanic	Yes	82	0	2	2	3	5	8	10	20	35	121	121	121
Employment	Full Time	542	1	2	3	4	5	7	10	30	121	121	121	121
Employment	Part Time	107	2	3	4	5	5	10	10	30	120	121	121	121
Employment	Not Employed	186	1	1	3	4	5	10	10	20	40	120	120	121
Education	< High School	70	0	2	3	4.5	5	10	30	121	121	121	121	121
Education	High School Graduate	293	1	2	3	5	5	8	15	30	121	121	121	121
Education	< College	213	1	2	2	4	5	8	10	15	60	121	121	121
Education	College Graduate	143	2	2	3	4	5	5	10	15	30	121	121	121
Education	Post Graduate	106	1	2	3	3	5	7	10	15	35	56	90	120
Census Region	Northeast	167	1	2	3	5	5	5	10	30	121	121	121	121
Census Region	Midwest	246	0	2	2	3	5	8	10	30	120	121	121	121
Census Region	South	348	0	1	3	4	5	6.5	10	20	45	120	121	121
Census Region	West	206	2	2	3	4	5	8	10	20	70	121	121	121
Day of Week	Weekday	634	1	2	3	4	5	7	10	30	121	121	121	121
Day of Week	Weekend	333	1	1	3	4	5	5	10	15	30	120	121	121
Season	Winter	236	1	1	3	4	5	6	10	20	60	121	121	121
Season	Spring	232	2	2	3	5	5	7.5	15	30	120	121	121	121
Season	Summer	282	0	2	3	4	5	10	10	30	120	121	121	121
Season	Fall	217	1	2	2	3	5	5	10	15	35	121	121	121
Asthma	No	892	1	2	3	4	5	7	10	25	90	121	121	121
Asthma	Yes	74	0	2	2	3	5	5	10	30	120	121	121	121
Angina	No	947	1	2	3	4	5	6	10	30	90	121	121	121
Angina	Yes	17	3	3	3	4	10	10	15	15	121	121	121	121
Bronchitis/Emphysema	No	920	1	2	3	4	5	7	10	25	60	121	121	121
Bronchitis/Emphysema	Yes	45	2	2	2	3	5	5	15	120	120	121	121	121

Note: A value of "121" for number of minutes signifies that more than 120 minutes were spent. N = doer sample size. Percentiles are the percentage of doers below or equal to a given number of minutes.  
Source: Tsang and Klepeis, 1996.





Table 15-40. Number of Minutes Spent at Home While the Windows Were Left Open (minutes/day)													
Category	Population Group	N	Percentiles										
			1	2	5	10	25	50	75	90	95	98	99
Overall		1960	2	10	30	180	360	840	961	961	961	961	961
Gender	Male	893	5	10	30	180	360	840	961	961	961	961	961
Gender	Female	1067	2	10	30	119	360	840	961	961	961	961	961
Age (years)	1-4	99	0	1	10	180	180	600	961	961	961	961	961
Age (years)	5-11	159	3	10	20	60	360	600	961	961	961	961	961
Age (years)	12-17	101	2	5	24	180	360	600	961	961	961	961	961
Age (years)	18-64	1282	6	16	60	180	360	840	961	961	961	961	961
Age (years)	> 64	282	1	5	30	180	360	840	961	961	961	961	961
Race	White	1558	2	10	30	180	360	840	961	961	961	961	961
Race	Black	208	3	10	30	180	360	840	961	961	961	961	961
Race	Asian	47	10	10	16	180	360	600	961	961	961	961	961
Race	Some Others	44	1	1	60	90	180	600	961	961	961	961	961
Race	Hispanic	80	2	20	30	60	360	600	961	961	961	961	961
Hispanic	No	1775	2	10	30	180	360	840	961	961	961	961	961
Hispanic	Yes	156	20	20	30	180	180	840	961	961	961	961	961
Employment	Full Time	822	5	15	30	180	360	840	961	961	961	961	961
Employment	Part Time	190	1	7	30	60	180	840	961	961	961	961	961
Employment	Not Employed	576	5	10	60	180	360	840	961	961	961	961	961
Education	< High School	163	1	6	30	90	360	840	961	961	961	961	961
Education	High School Graduate	542	2	10	60	180	360	840	961	961	961	961	961
Education	< College	408	5	15	30	119	360	840	961	961	961	961	961
Education	College Graduate	247	15	15	60	100	360	840	961	961	961	961	961
Education	Post Graduate	216	10	10	30	180	360	840	961	961	961	961	961
Census Region	Northeast	498	3	10	30	119	360	840	961	961	961	961	961
Census Region	Midwest	390	5	10	60	180	360	840	961	961	961	961	961
Census Region	South	494	1	6	30	90	360	600	961	961	961	961	961
Census Region	West	578	2	10	30	180	360	840	961	961	961	961	961
Day of Week	Weekday	1285	3	10	30	180	360	840	961	961	961	961	961
Day of Week	Weekend	675	2	10	30	119	360	840	961	961	961	961	961
Season	Winter	308	1	2	10	24	180	360	961	961	961	961	961
Season	Spring	661	10	20	60	180	360	600	961	961	961	961	961
Season	Summer	680	10	30	180	180	600	961	961	961	961	961	961
Season	Fall	311	3	5	30	60	180	600	961	961	961	961	961
Asthma	No	1809	2	10	30	180	360	840	961	961	961	961	961
Asthma	Yes	145	5	10	60	118	360	840	961	961	961	961	961
Angina	No	1902	3	10	30	180	360	840	961	961	961	961	961
Angina	Yes	49	1	1	24	30	180	961	961	961	961	961	961
Bronchitis/Emphysema	No	1850	2	10	30	180	360	840	961	961	961	961	961
Bronchitis/Emphysema	Yes	100	5	15	35	180	480	961	961	961	961	961	961

Note: Values of "180", "360", "600", "840" and "961" for number of minutes signify that 2-4 hours, 4-8 hours, 8-12 hours, 12-16 hours, and more than 16 hours, respectively, were spent. N = doer sample size. Percentiles are the percentage of doers below or equal to a given number of minutes. Source: Tsang and Klepeis, 1996.



Table 15-41. Number of Minutes the Outside Door Was Left Open While at Home (minutes/day)

Category	Population Group	N	Percentiles											
			1	2	5	10	25	50	75	90	95	98	99	100
Overall		1170	0	1	5	10	60	180	600	600	721	721	721	721
Gender	Male	505	0	1	3	10	60	180	600	600	721	721	721	721
Gender	Female	665	1	1	5	10	60	180	600	600	721	721	721	721
Age (years)	1-4	68	0	0	2	10	30	180	360	721	721	721	721	721
Age (years)	5-11	109	0	1	3	10	60	180	600	600	721	721	721	721
Age (years)	12-17	79	0	1	3	5	60	180	360	600	721	721	721	721
Age (years)	18-64	718	1	1	3	10	60	180	600	600	721	721	721	721
Age (years)	> 64	180	1	1	10	20	180	360	600	721	721	721	721	721
Race	White	968	0	1	5	10	60	180	600	600	721	721	721	721
Race	Black	100	1	2.5	5.5	13	60	180	600	600	600	660.5	721	721
Race	Asian	23	1	1	2	60	180	360	600	600	721	721	721	721
Race	Some Others	22	1	1	1	15	30	180	600	600	721	721	721	721
Race	Hispanic	45	0	0	5	5	45	180	360	600	600	721	721	721
Hispanic	No	1073	0	1	3	10	60	180	600	600	721	721	721	721
Hispanic	Yes	81	0	1	5	10	45	180	360	600	600	721	721	721
Employment	Full Time	451	1	1	3	10	60	180	600	600	721	721	721	721
Employment	Part Time	93	0	3	5	15	60	180	600	600	721	721	721	721
Employment	Not Employed	362	1	1	5	10	60	360	600	600	721	721	721	721
Education	< High School	96	1	1	2	11	75	360	600	600	721	721	721	721
Education	High School Graduate	309	1	3	5	10	60	180	600	600	721	721	721	721
Education	< College	225	0	1	3	10	60	180	600	600	721	721	721	721
Education	College Graduate	150	0	0.5	1	15	60	180	600	600	721	721	721	721
Education	Post Graduate	124	2	2	3	5	30	180	600	600	721	721	721	721
Census Region	Northeast	223	1	2	5	10	90	180	600	600	721	721	721	721
Census Region	Midwest	221	0	0	2	10	60	180	600	600	721	721	721	721
Census Region	South	361	1	1	5	10	60	180	360	600	600	721	721	721
Census Region	West	365	0	1	5	15	60	180	600	600	721	721	721	721
Day of Week	Weekday	732	0	1	5	10	60	180	600	600	721	721	721	721
Day of Week	Weekend	438	1	1	5	10	60	180	600	600	721	721	721	721
Season	Winter	184	0	0	2	3	10	60	180	600	600	600	600	600
Season	Spring	407	1	1	5	20	180	360	600	600	721	721	721	721
Season	Summer	385	0	2	10	30	180	360	600	721	721	721	721	721
Season	Fall	194	1	1	2	10	30	180	360	600	600	600	600	600
Asthma	No	1072	0	1	5	10	60	180	600	600	721	721	721	721
Asthma	Yes	97	1	1	3	6	30	180	600	600	721	721	721	721
Angina	No	1133	0	1	5	10	60	180	600	600	721	721	721	721
Angina	Yes	36	1	1	3	10	104.5	360	360	600	721	721	721	721
Bronchitis/emphysema	No	1105	0	1	3	10	60	180	600	600	721	721	721	721
Bronchitis/emphysema	Yes	63	5	5	10	10	90	180	600	600	721	721	721	721

Note: Values of "180", "360", "600", and "721" for number of minutes signify that 2-4 hours, 4-8 hours, 8-12 hours, and over 12 hours, respectively, were spent. N = doer sample size. Percentiles are the percentage of doers below or equal to a given number of minutes.  
Source: Tsang and Klepeis, 1996.



Table 15-42. Number of Times an Outside Door Was Opened in the Home at Specified Daily Frequencies by the Number of Respondents							
	Total N	Times/Day					DK
		1-2	3-5	6-9	10-19	20+	
<b>Overall</b>	1187	192	248	229	267	196	55
<b>Gender</b>							
Male	511	80	96	100	118	93	24
Female	676	112	152	129	149	103	31
<b>Age (years)</b>							
*	19	6	3	2	3	1	4
1-4	68	13	14	8	17	13	3
5-11	109	15	16	18	31	23	6
12-17	79	11	17	17	13	17	4
18-64	730	112	145	156	171	123	23
> 64	182	35	53	28	32	19	15
<b>Race</b>							
White	979	155	193	188	233	168	42
Black	103	22	28	21	12	14	6
Asian	23	1	9	4	6	2	1
Some Others	22	3	4	2	7	4	2
Hispanic	46	8	11	10	8	8	1
Refused	14	3	3	4	1	*	3
<b>Hispanic</b>							
No	1086	179	227	208	244	180	48
Yes	83	11	17	16	20	15	4
DK	7	*	2	1	3	1	*
Refused	11	2	2	4	*	*	3
<b>Employment</b>							
*	255	40	46	43	60	53	13
Full Time	458	79	98	95	104	72	10
Part Time	95	14	20	19	22	18	2
Not Employed	369	58	81	69	80	52	29
Refused	10	1	3	3	1	1	1
<b>Education</b>							
*	267	42	48	46	63	54	14
< High School	98	21	17	15	18	20	7
High School Graduate	318	48	66	65	71	54	14
< College	228	44	52	37	49	34	12
College Graduate	150	21	37	39	31	19	3
Post Graduate	126	16	28	27	35	15	5
<b>Census Region</b>							
Northeast	228	37	38	49	53	38	13
Midwest	225	44	54	39	50	33	5
South	365	59	81	69	71	66	19
West	369	52	75	72	93	59	18
<b>Day of Week</b>							
Weekday	746	116	167	156	167	106	34
Weekend	441	76	81	73	100	90	21
<b>Season</b>							
Winter	185	19	51	39	42	27	7
Spring	417	73	94	66	90	73	21
Summer	387	72	68	81	80	66	20
Fall	198	28	35	43	55	30	7
<b>Asthma</b>							
No	1087	175	228	211	245	179	49
Yes	99	16	20	18	22	17	6
DK	1	1	*	*	*	*	*
<b>Angina</b>							
No	1147	183	241	221	259	192	51
Yes	39	8	7	8	8	4	4
DK	1	1	*	*	*	*	*
<b>Bronchitis/emphysema</b>							
No	1121	179	230	216	258	186	52
Yes	64	12	18	12	9	10	3
DK	2	1	*	1	*	*	*

Note: \* Signifies missing data; "DK" = respondent answered don't know; N = sample size; Refused = respondent refused to answer.  
Source: Tsang and Klepeis, 1996



Table 15-43. Number of Minutes Spent Running, Walking, or Standing Alongside a Road with Heavy Traffic (minutes/day)

Category	Population Group	N	Percentiles											
			1	2	5	10	25	50	75	90	95	98	99	100
Overall		401	0	1	2	2	5	15	30	60	121	121	121	121
Gender	Male	202	1	1	2	3	5	17.5	45	120	121	121	121	121
Gender	Female	198	0	0	1	2	5	10	30	60	120	121	121	121
Age (years)	1-4	12	1	1	1	2	4	7.5	30	60	60	60	60	60
Age (years)	5-11	20	1	1	1.5	2	5	6	12.5	25	60	90	90	90
Age (years)	12-17	27	0	0	2	2	4	5	30	60	90	120	120	120
Age (years)	18-64	304	0	1	1	2	5	15	30	90	121	121	121	121
Age (years)	> 64	31	2	2	2	4	5	20	45	60	121	121	121	121
Race	White	306	0	1	2	2	5	15	30	110	121	121	121	121
Race	Black	51	0	0	1	1	3	7	30	50	60	60	121	121
Race	Asian	10	3	3	3	4	5	7.5	15	17.5	20	20	20	20
Race	Some Others	7	2	2	2	2	5	10	45	121	121	121	121	121
Race	Hispanic	24	2	2	2	3	10	17.5	40	60	60	120	120	120
Hispanic	No	356	0	1	1	2	5	15	30	90	121	121	121	121
Hispanic	Yes	43	1	1	2	2	5	10	30	60	120	121	121	121
Employment	Full Time	214	0	1	1	2	5	15	30	120	121	121	121	121
Employment	Part Time	50	0	0.5	2	2	5	15	30	90	121	121	121	121
Employment	Not Employed	76	0	1	2	3	5.5	15	30	60	110	120	121	121
Education	< High School	18	4	4	4	5	6	10	15	30	121	121	121	121
Education	High School Graduate	106	1	1	2	2	5	15	60	121	121	121	121	121
Education	< College	84	0	0	1	3	5.5	20	40	120	121	121	121	121
Education	College Graduate	79	0	1	1	2	5	15	30	60	90	121	121	121
Education	Post Graduate	50	1	1	2	2	5	10	20	52.5	90	120	120	120
Census Region	Northeast	129	1	1	2	2	5	20	50	120	121	121	121	121
Census Region	Midwest	83	0	0	1	2	5	10	20	60	121	121	121	121
Census Region	South	105	0	0	1	2	5	15	30	90	121	121	121	121
Census Region	West	84	1	2	2	3	5	15	30	60	120	121	121	121
Day of Week	Weekday	303	0	0	2	2	5	15	30	60	120	121	121	121
Day of Week	Weekend	98	1	1	2	3	5	15	30	121	121	121	121	121
Season	Winter	104	0	0	1	2	4.5	10	20	60	110	121	121	121
Season	Spring	114	1	1	2	2	6	20	60	120	121	121	121	121
Season	Summer	104	0	1	2	2	5	10	30	60	121	121	121	121
Season	Fall	79	0	1	2	3	5	20	35	120	121	121	121	121
Asthma	No	370	0	1	2	2	5	15	30	60	121	121	121	121
Asthma	Yes	31	0	0	1	2	5	15	30	120	121	121	121	121
Angina	No	393	0	1	2	2	5	15	30	90	121	121	121	121
Angina	Yes	8	2	2	2	2	6.5	17.5	30	60	60	60	60	60
Bronchitis/Emphysema	No	378	0	1	1	2	5	15	30	60	121	121	121	121
Bronchitis/Emphysema	Yes	22	2	2	5	5	5	17.5	30	121	121	121	121	121

NOTE: A value of "121" for number of minutes signifies that more than 120 minutes were spent. N = doer sample size. Percentiles are the percentage of doers below or equal to a given number of minutes.  
Source: Tsang and Klepeis, 1996



Table 15-44. Number of Minutes Spent in a Car, Van, Truck, or Bus in Heavy Traffic (minutes/day)														
Category	Population Group	N	Percentiles											
			1	2	5	10	25	50	75	90	95	98	99	100
Overall		1197	1	2	5	5	10	20	60	120	121	121	121	121
Gender	Male	534	1	2	4	5	10	20	60	120	121	121	121	121
Gender	Female	663	1	2	5	5	10	25	60	120	121	121	121	121
Age (years)	1-4	33	4	4	5	5	10	15	30	60	60	121	121	121
Age (years)	5-11	63	1	2	5	5	10	20	45	60	120	121	121	121
Age (years)	12-17	52	3	3	4	5	9	12.5	27.5	90	120	120	121	121
Age (years)	18-64	889	1	2	5	5	10	25	60	120	121	121	121	121
Age (years)	> 64	139	3	3	5	5	15	30	60	121	121	121	121	121
Race	White	959	1	2	4	5	10	25	60	120	121	121	121	121
Race	Black	133	2	3	5	5	10	20	40	90	120	121	121	121
Race	Asian	20	5	5	5	5	11	20	30	45	52.5	60	60	60
Race	Some Others	24	5	5	10	10	12.5	30	60	90	120	121	121	121
Race	Hispanic	55	1	2	5	5	10	20	60	120	121	121	121	121
Hispanic	No	1097	1	2	5	5	10	20	60	120	121	121	121	121
Hispanic	Yes	95	1	2	5	5	10	20	90	121	121	121	121	121
Employment	Full Time	659	1	2	5	5	10	30	60	120	121	121	121	121
Employment	Part Time	108	2	2	4	5	10	20	48.5	121	121	121	121	121
Employment	Not Employed	279	1	2	5	5	10	30	60	120	121	121	121	121
Education	< High School	81	0	3	5	10	10	20	40	121	121	121	121	121
Education	High School Graduate	352	1	2	5	5	10	30	60	120	121	121	121	121
Education	< College	276	1	2	3	5	15	30	60	120	121	121	121	121
Education	College Graduate	176	1	2	4	5	12.5	30	60	120	121	121	121	121
Education	Post Graduate	150	2	2	5	5	10	20	60	97.5	120	121	121	121
Census Region	Northeast	229	2	2	4	5	10	20	60	120	121	121	121	121
Census Region	Midwest	263	2	2	5	5	10	30	45	120	121	121	121	121
Census Region	South	429	1	2	5	5	10	30	60	120	121	121	121	121
Census Region	West	276	1	2	5	5	10	20	60	120	121	121	121	121
Day of Week	Weekday	927	1	2	5	5	10	20	60	120	121	121	121	121
Day of Week	Weekend	270	2	2	5	5	10	25	60	120	121	121	121	121
Season	Winter	286	1	2	5	5	10	20	60	120	121	121	121	121
Season	Spring	317	1	2	5	5	10	30	60	120	121	121	121	121
Season	Summer	312	1	3	5	5	10	30	60	120	121	121	121	121
Season	Fall	282	2	2	4	5	10	20	45	120	121	121	121	121
Asthma	No	1108	1	2	5	5	10	20	60	120	121	121	121	121
Asthma	Yes	89	2	2	5	5	10	30	60	121	121	121	121	121
Angina	No	1159	1	2	5	5	10	20	60	120	121	121	121	121
Angina	Yes	35	0	0	5	5	10	30	70	121	121	121	121	121
Bronchitis/emphysema	No	1130	2	2	5	5	10	20	60	120	121	121	121	121
Bronchitis/emphysema	Yes	64	1	1	2	5	10	27.5	51	120	121	121	121	121

NOTE: A value of "121" for number of minutes signifies that more than 120 minutes were spent. N = doer sample size. Percentiles are the percentage of doers below or equal to a given number of minutes.  
Source: Tsang and Klepeis, 1996



Table 15-45. Number of Minutes Spent in a Parking Garage or Indoor Parking Lot (minutes/day)

Category	Population Group	N	Percentiles											
			1	2	5	10	25	50	75	90	95	98	99	100
Overall		294	0	1	1	2	3	5	10	30	60	121	121	121
Gender	Male	138	1	1	1	2	4	5	15	60	121	121	121	121
Gender	Female	156	0	1	1	2	3	5	10	20	40	60	120	121
Age (years)	1-4	8	0	0	0	0	2	3.5	5	10	10	10	10	10
Age (years)	5-11	15	1	1	1	2	3	5	10	45	60	60	60	60
Age (years)	12-17	20	0	0	0.5	1.5	2	7.5	15	45	90.5	121	121	121
Age (years)	18-64	229	1	1	2	2	5	5	10	30	60	121	121	121
Age (years)	> 64	18	0	0	0	2	3	5	15	45	90	90	90	90
Race	White	208	1	1	2	2	3	5	10	30	60	121	121	121
Race	Black	34	0	0	1	1	5	5	15	20	30	30	30	30
Race	Asian	15	2	2	2	2	2	10	60	120	121	121	121	121
Race	Some Others	7	3	3	3	3	3	5	15	121	121	121	121	121
Race	Hispanic	28	1	1	1	2	4.5	10	20	60	120	121	121	121
Hispanic	No	251	0	1	1	2	3	5	10	30	60	120	121	121
Hispanic	Yes	39	1	1	1	3	5	10	30	121	121	121	121	121
Employment	Full Time	171	1	1	1	2	3	5	10	30	60	121	121	121
Employment	Part Time	23	2	2	5	5	5	5	10	30	60	121	121	121
Employment	Not Employed	58	0	1	1	2	4	10	20	40	120	121	121	121
Education	< High School	13	0	0	0	5	5	10	10	30	121	121	121	121
Education	High School Graduate	58	1	1	1	2	3	9.5	30	90	121	121	121	121
Education	< College	54	1	1	2	2	4	5	15	40	120	120	121	121
Education	College Graduate	72	1	1	2	2	4.5	5	10	15	60	120	121	121
Education	Post Graduate	50	1	1	2	2	5	5	10	12.5	20	40	60	60
Census Region	Northeast	53	2	2	2	2	5	6	10	30	90	121	121	121
Census Region	Midwest	59	0	0	1	2	3	5	10	30	60	121	121	121
Census Region	South	92	1	1	2	2	3.5	5	10	30	60	121	121	121
Census Region	West	90	0	1	1	1.5	4	5	15	45	60	121	121	121
Day of Week	Weekday	208	0	1	1	2	3	5	10	30	60	121	121	121
Day of Week	Weekend	86	1	1	2	2	5	7	15	30	60	121	121	121
Season	Winter	67	0	1	1	2	3	5	10	20	30	120	121	121
Season	Spring	78	0	1	1	2	3	5.5	15	60	120	121	121	121
Season	Summer	85	0	1	2	2	5	5	15	30	90	121	121	121
Season	Fall	64	1	1	2	2	4.5	5	10	30	45	121	121	121
Asthma	No	263	1	1	2	2	3	5	10	30	60	121	121	121
Asthma	Yes	30	0	0	1	1	4	7	10	30	121	121	121	121
Angina	No	291	0	1	1	2	4	5	10	30	60	121	121	121
Angina	Yes	2	3	3	3	3	3	46.5	90	90	90	90	90	90
Bronchitis/emphysema	No	281	0	1	1	2	3	5	10	30	60	121	121	121
Bronchitis/emphysema	Yes	12	2	2	2	5	5	5.5	10	60	120	120	120	120

NOTE: A value of "121" for number of minutes signifies that more than 120 minutes were spent. N = doer sample size. Percentiles are the percentage of doers below or equal to a given number of minutes.  
Source: Tsang and Klepeis, 1996



Category	Population Group	N	Percentiles											
			1	2	5	10	25	50	75	90	95	98	99	100
Overall		3303	0	0	0	0	2	5	10	20	30	60	121	121
Gender	Male	1511	0	0	0	0	2	4	10	20	30	60	121	121
Gender	Female	1791	0	0	0	0	2	5	10	20	30	60	60	121
Age (years)	1-4	132	0	0	0	0	1.5	2	5	15	20	30	60	121
Age (years)	5-11	245	0	0	0	0	1	2	5	15	30	45	80	121
Age (years)	12-17	202	0	0	0	0	1	5	10	20	30	30	60	121
Age (years)	18-64	2303	0	0	0	0	2	5	10	20	30	60	120	121
Age (years)	> 64	373	0	0	0	1	2	5	10	15	30	30	88	121
Race	White	2756	0	0	0	0	2	5	10	20	30	60	120	121
Race	Black	279	0	0	0	0	1	3	5	10	20	30	45	88
Race	Asian	53	0	0	0	0	1	3	10	15	30	32	45	45
Race	Some Others	63	0	0	0	0	2	5	10	30	30	60	120	120
Race	Hispanic	127	0	0	1	1	2	5	10	20	60	120	121	121
Hispanic	No	3029	0	0	0	0	2	5	10	20	30	60	120	121
Hispanic	Yes	235	0	0	0	0	2	5	10	20	60	120	121	121
Employment	Full Time	1613	0	0	0	0	2	5	10	20	30	60	120	121
Employment	Part Time	312	0	0	0	1	2	5	10	20	45	120	121	121
Employment	Not Employed	785	0	0	0	0	2	5	10	20	30	60	60	121
Education	< High School	241	0	0	0	0	2	4	10	20	30	110	121	121
Education	High School Graduate	935	0	0	0	0	2	5	10	20	30	60	121	121
Education	< College	680	0	0	0	1	2	5	10	20	30	60	120	121
Education	College Graduate	445	0	0	0	0	2	5	10	20	30	60	60	121
Education	Post Graduate	381	0	0	0	1	2	5	10	15	25	30	120	121
Census Region	Northeast	680	0	0	0	0	2	5	10	15	30	60	90	121
Census Region	Midwest	763	0	0	0	1	2	5	10	15	30	60	120	121
Census Region	South	1149	0	0	0	0	2	4	10	20	30	60	90	121
Census Region	West	711	0	0	0	0	2	5	10	20	30	60	120	121
Day of Week	Weekday	2209	0	0	0	0	2	5	10	20	30	60	120	121
Day of Week	Weekend	1094	0	0	0	0	2	5	10	20	30	60	120	121
Season	Winter	855	0	0	0	0	1	4	10	15	30	30	100	121
Season	Spring	890	0	0	0	0	2	5	10	20	30	100	120	121
Season	Summer	903	0	0	0	0	2	4	10	20	30	60	60	121
Season	Fall	655	0	0	0	1	2	5	10	15	30	45	110	121
Asthma	No	3063	0	0	0	0	2	5	10	20	30	60	120	121
Asthma	Yes	234	0	0	0	1	2	5	10	15	30	120	121	121
Angina	No	3219	0	0	0	0	2	5	10	20	30	60	120	121
Angina	Yes	72	0	0	0	0	2	5	10	15	30	45	110	110
Bronchitis/Emphysema	No	3132	0	0	0	0	2	5	10	20	30	60	120	121
Bronchitis/Emphysema	Yes	162	0	0	0	0	2	5	10	20	30	110	121	121

NOTE: A value of "121" for number of minutes signifies that more than 120 minutes were spent. N = doer sample size. Percentiles are the percentage of doers below or equal to a given number of minutes.  
Source: Tsang and Klepeis, 1996



Table 15-47. Number of Minutes Spent Running or Walking Outside Other Than to the Car (minutes/day)

Category	Population Group	N	Percentiles											
			1	2	5	10	25	50	75	90	95	98	99	100
Overall		1273	1	1	3	5	15	45	120	121	121	121	121	121
Gender	Male	605	2	2	5	10	20	60	121	121	121	121	121	121
Gender	Female	668	0	1	2	5	15	30	116	121	121	121	121	121
Age (years)	1-4	82	3	3	5	10	30	120	121	121	121	121	121	21
Age (years)	5-11	149	4	5	5	10	30	120	121	121	121	121	121	21
Age (years)	12-17	110	5	5	5	10	15	60	121	121	121	121	121	121
Age (years)	18-64	772	0	1	2	5	15	30	120	121	121	121	121	121
Age (years)	5:> 64	143	1	1	2	5	15	30	60	121	121	121	121	121
Race	White	1051	1	1	3	5	15	45	121	121	121	121	121	121
Race	Black	111	0	1	3	5	15	35	120	121	121	121	121	121
Race	Asian	21	2	2	10	10	15	30	70	120	121	121	121	121
Race	Some Others	23	5	5	10	15	20	60	121	121	121	121	121	121
Race	5:hispanic	55	2	3	8	10	20	40	90	121	121	121	121	121
Hispanic	No	1156	1	1	3	5	15	45	120	121	121	121	121	121
Hispanic	Yes	99	1	2	2	10	20	60	121	121	121	121	121	121
Employment	Full Time	517	0	1	2	5	15	30	120	121	121	121	121	121
Employment	Part Time	112	1	2	2	5	15	30	90	121	121	121	121	121
Employment	Not Employed	300	1	1	3	5	15	30	120	121	121	121	121	121
Education	< High School	97	0	1	3	5	15	30	90	121	121	121	121	121
Education	High School Graduate	287	0	0	2	5	15	30	120	121	121	121	121	121
Education	< College	234	1	1	2	5	15	30	120	121	121	121	121	121
Education	College Graduate	153	1	2	5	10	20	45	120	121	121	121	121	121
Education	Post Graduate	138	1	1	3	5	15	37.5	90	121	121	121	121	121
Census Region	Northeast	265	1	1	3	5	20	45	120	121	121	121	121	121
Census Region	Midwest	286	1	2	5	5	15	40	121	121	121	121	121	121
Census Region	South	412	1	1	3	5	15	45	121	121	121	121	121	121
Census Region	West	310	1	1	3	5.5	15	45	120	121	121	121	121	121
Day of Week	Weekday	843	1	1	3	5	15	40	120	121	121	121	121	121
Day of Week	Weekend	430	1	2	4	5	20	60	121	121	121	121	121	21
Season	Winter	312	0	2	2	5	10	42.5	90	121	121	121	121	21
Season	Spring	403	1	2	4	10	20	60	121	121	121	121	121	121
Season	Summer	396	1	1	3	10	20	55	121	121	121	121	121	21
Season	Fall	162	1	1	2	5	15	30	120	121	121	121	121	121
Asthma	No	1162	1	1	3	5	15	45	120	121	121	121	121	21
Asthma	Yes	105	2	4	5	6	15	45	121	121	121	121	121	21
Angina	No	1240	1	1	3	5	15	45	120	121	121	121	121	121
Angina	Yes	25	1	1	5	5	15	45	121	121	121	121	121	121
Bronchitis/Emphysema	No	1204	1	1	3	5	15	45	120	121	121	121	121	121
Bronchitis/Emphysema	Yes	62	1	2	4	5	15	30	120	121	121	121	121	121

NOTE: A value of "121" for number of minutes signifies that more than 120 minutes were spent. N = doer sample size. Percentiles are the percentage of doers below or equal to a given number of minutes.  
Source: Tsang and Klepeis,1996





Table 15-48. Number of Hours Spent Working for Pay (hours/week)														
Category	Population Group	N	Percentiles											
			1	2	5	10	25	50	75	90	95	98	99	100
Overall		4896	0	0	0	12	33	40	50	60	61	61	61	61
Gender	Male	2466	0	0	0	18	40	40	53	61	61	61	61	61
Gender	Female	2430	0	0	0	6	28	40	43	55	60	61	61	61
Age (years)	1-4	0	*	*	*	*	*	*	*	*	*	*	*	*
Age (years)	5-11	0	*	*	*	*	*	*	*	*	*	*	*	*
Age (years)	12-17	14	0	0	0	1	9	18.5	24	26	31	31	31	31
Age (years)	18-64	4625	0	0	0	15	35	40	50	60	61	61	61	61
Age (years)	> 64	181	0	0	0	0	5	21	40	50	61	61	61	61
Race	White	3990	0	0	0	10	32	40	50	60	61	61	61	61
Race	Black	499	0	0	0	18	35	40	46	60	61	61	61	61
Race	Asian	76	0	0	0	7	36.5	40	50	61	61	61	61	61
Race	Some Others	87	0	0	0	0	30	40	50	60	61	61	61	61
Race	Hispanic	194	0	0	0	15	32	40	48	60	60	61	61	61
Hispanic	No	4494	0	0	0	12	33	40	50	60	61	61	61	61
Hispanic	Yes	341	0	0	0	8	32	40	50	60	61	61	61	61
Employment	Full Time	4094	0	0	0	30	40	40	50	60	61	61	61	61
Employment	Part Time	802	0	0	0	0	10	20	30	38	40	61	61	61
Employment	Not Employed	0	*	*	*	*	*	*	*	*	*	*	*	*
Education	< High School	308	0	0	0	1	21	40	48	61	61	61	61	61
Education	High School Graduate	1598	0	0	0	12	32	40	48	60	61	61	61	61
Education	< College	1251	0	0	0	15	30	40	50	60	61	61	61	61
Education	College Graduate	954	0	0	0	16	40	40	50	60	61	61	61	61
Education	Post Graduate	716	0	0	0	10	35	40	50	60	61	61	61	61
Census Region	Northeast	1096	0	0	0	14	32	40	50	60	61	61	61	61
Census Region	Midwest	1118	0	0	0	12	32	40	50	60	61	61	61	61
Census Region	South	1675	0	0	0	12	35	40	50	60	61	61	61	61
Census Region	West	1007	0	0	0	9	30	40	50	60	61	61	61	61
Day of Week	Weekday	3306	0	0	0	10	33	40	50	60	61	61	61	61
Day of Week	Weekend	1590	0	0	0	12	33	40	48	60	61	61	61	61
Season	Winter	1306	0	0	0	10	32	40	50	60	61	61	61	61
Season	Spring	1197	0	0	0	15	35	40	50	60	61	61	61	61
Season	Summer	1343	0	0	0	3	33	40	48	60	61	61	61	61
Season	Fall	1050	0	0	0	14.5	32	40	50	60	61	61	61	61
Asthma	No	4579	0	0	0	12	34	40	50	60	61	61	61	61
Asthma	Yes	302	0	0	0	9	30	40	48	60	61	61	61	61
Angina	No	4811	0	0	0	12	34	40	50	60	61	61	61	61
Angina	Yes	66	0	0	0	0	20	40	44	60	61	61	61	61
Bronchitis/Emphysema	No	4699	0	0	0	12	33	40	50	6	61	61	61	61
Bronchitis/Emphysema	Yes	182	0	0	0	6	30	40	48	60	61	61	61	61

Note: \* Signifies missing data. A value of "61" for number of hours signifies that more than 60 hours were spent. N = doer sample size. Percentiles are the percentage of doers below or equal to a given number of hours.  
Source: Tsang and Klepeis, 1996.



Table 15-49. Number of Hours Spent Working for Pay Between 6PM and 6AM (hours/week)

Category	Population Group	N	Percentiles											
			1	2	5	10	25	50	75	90	95	98	99	100
Overall		4894	0	0	0	0	0	0	8	30	45	61	61	61
Gender	Male	2465	0	0	0	0	0	0	10	35	50	61	61	61
Gender	Female	2429	0	0	0	0	0	0	5	20	39	61	61	61
Age (years)	1-4	0	0	0	0	0	0	0	0	0	0	0	0	0
Age (years)	5-11	0	0	0	0	0	0	0	0	0	0	0	0	0
Age (years)	12-17	14	0	0	0	0	0	4.5	20	24	25	25	25	25
Age (years)	18-64	4623	0	0	0	0	0	0	8	30	42	61	61	61
Age (years)	> 64	181	0	0	0	0	0	0	0	20	61	61	61	61
Race	White	3989	0	0	0	0	0	0	8	25	40	61	61	61
Race	Black	499	0	0	0	0	0	0	10	40	61	61	61	61
Race	Asian	75	0	0	0	0	0	0	12	30	61	61	61	61
Race	Some Others	87	0	0	0	0	0	0	7	25	45	61	61	61
Race	Hispanic	194	0	0	0	0	0	0	15	35	48	61	61	61
Hispanic	No	4492	0	0	0	0	0	0	8	27	40	61	61	61
Hispanic	Yes	341	0	0	0	0	0	0	13	35	50	61	61	61
Employment	Full Time	4092	0	0	0	0	0	0	8	30	45	61	61	61
Employment	Part Time	802	0	0	0	0	0	0	6	20	35	61	61	61
Employment	Not Employed	0	0	0	0	0	0	0	0	0	0	0	0	0
Education	< High School	308	0	0	0	0	0	0	11	50	61	61	61	61
Education	High School Graduate	1597	0	0	0	0	0	0	8	35	50	61	61	61
Education	< College	1251	0	0	0	0	0	0	9	26	40	60	61	61
Education	College Graduate	953	0	0	0	0	0	0	8	20	40	61	61	61
Education	Post Graduate	716	0	0	0	0	0	0	7	20	30	61	61	61
Census Region	Northeast	1096	0	0	0	0	0	0	7	24	40	61	61	61
Census Region	Midwest	1118	0	0	0	0	0	0	10	30	42	61	61	61
Census Region	South	1674	0	0	0	0	0	0	7	30	48	61	61	61
Census Region	West	1006	0	0	0	0	0	0	10	30	47	61	61	61
Day of Week	Weekday	3306	0	0	0	0	0	0	8	30	48	61	61	61
Day of Week	Weekend	1588	0	0	0	0	0	0	7	28	40	61	61	61
Season	Winter	1305	0	0	0	0	0	0	8	28	40	61	61	61
Season	Spring	1197	0	0	0	0	0	0	8	30	48	61	61	61
Season	Summer	1342	0	0	0	0	0	0	9	30	48	61	61	61
Season	Fall	1050	0	0	0	0	0	0	7	25	40	61	61	61
Asthma	No	4578	0	0	0	0	0	0	8	30	45	61	61	61
Asthma	Yes	301	0	0	0	0	0	0	8	28	36	61	61	61
Angina	No	4809	0	0	0	0	0	0	8	30	44	61	61	61
Angina	Yes	66	0	0	0	0	0	0	7	36	40	61	61	61
Bronchitis/Emphysema	No	4697	0	0	0	0	0	0	8	30	43	61	61	61
Bronchitis/Emphysema	Yes	182	0	0	0	0	0	0	10	40	50	61	61	61

Note: A Value of "61" for number of hours signifies that more than 60 hours were spent. N = doer sample size. Percentiles are the percentage of doers below or equal to a given number of hours.  
Source: Tsang and Klepeis, 1996.



Category	Population Group	N	Percentiles											
			1	2	5	10	25	50	75	90	95	98	99	100
Overall		4891	0	0	0	0	0	0	1	30	50	61	61	61
Gender	Male	2463	0	0	0	0	0	0	16	42	60	61	61	61
Gender	Female	2428	0	0	0	0	0	0	0	2	12	55	61	61
Age (years)	1-4	0	0	0	0	0	0	0	0	0	0	0	0	0
Age (years)	5-11	0	0	0	0	0	0	0	0	0	0	0	0	0
Age (years)	12-17	14	0	0	0	0	0	0	0	0	0	0	0	0
Age (years)	18-64	4621	0	0	0	0	0	0	1	30	50	61	61	61
Age (years)	> 64	181	0	0	0	0	0	0	2	29	60	61	61	61
Race	White	3986	0	0	0	0	0	0	2	30	50	61	61	61
Race	Black	499	0	0	0	0	0	0	0	25	48	61	61	61
Race	Asian	75	0	0	0	0	0	0	0	3	30	40	61	61
Race	Some Others	87	0	0	0	0	0	0	1	17	40	48	61	61
Race	Hispanic	194	0	0	0	0	0	0	2	30	50	61	61	61
Hispanic	No	4489	0	0	0	0	0	0	1	30	48	61	61	61
Hispanic	Yes	341	0	0	0	0	0	0	2	35	60	61	61	61
Employment	Full Time	4090	0	0	0	0	0	0	2	35	50	61	61	61
Employment	Part Time	801	0	0	0	0	0	0	0	15	30	61	61	61
Employment	Not Employed	0	0	0	0	0	0	0	0	0	0	0	0	0
Education	< High School	308	0	0	0	0	0	0	16.5	55	61	61	61	61
Education	High School Graduate	1594	0	0	0	0	0	0	6	40	60	61	61	61
Education	< College	1251	0	0	0	0	0	0	1	30	46	61	61	61
Education	College Graduate	953	0	0	0	0	0	0	0	20	35	50	61	61
Education	Post Graduate	716	0	0	0	0	0	0	0	4	15	60	61	61
Census Region	Northeast	1094	0	0	0	0	0	0	0	25	40	61	61	61
Census Region	Midwest	1117	0	0	0	0	0	0	0	30	50	61	61	61
Census Region	South	1674	0	0	0	0	0	0	2	32	55	61	61	61
Census Region	West	1006	0	0	0	0	0	0	2	33	50	61	61	61
Day of Week	Weekday	3305	0	0	0	0	0	0	1	32	50	61	61	61
Day of Week	Weekend	1586	0	0	0	0	0	0	1	30	48	61	61	61
Season	Winter	1305	0	0	0	0	0	0	0	25	50	61	61	61
Season	Spring	1195	0	0	0	0	0	0	2	30	50	61	61	61
Season	Summer	1341	0	0	0	0	0	0	2	36	50	61	61	61
Season	Fall	1050	0	0	0	0	0	0	0	30	45	61	61	61
Asthma	No	4576	0	0	0	0	0	0	1	30	50	61	61	61
Asthma	Yes	300	0	0	0	0	0	0	0	31	50	61	61	61
Angina	No	4806	0	0	0	0	0	0	1	30	50	61	61	61
Angina	Yes	66	0	0	0	0	0	0	4	35	50	61	61	61
Bronchitis/Emphysema	No	4694	0	0	0	0	0	0	1	30	50	61	61	61
Bronchitis/Emphysema	Yes	182	0	0	0	0	0	0	2	30	60	61	61	61

NOTE: A value of "61" for number of hours signifies that more than 60 hours were spent. N = doer sample size. Percentiles are the percentage of doers below or equal to a given number of hours.  
Source: Tsang and Klepeis, 1996



Table 15-51. Number of Times Floors Were Swept or Vacuumed at Specified Frequencies by the Number of Respondents								
	Total N	Number of Times						
		Almost Every Day	3-5/week	1-2/week	1-2/month	< Often	Never	DK
<b>Overall</b>	4663	921	1108	2178	373	48	10	25
<b>Gender</b>								
Male	2163	415	520	976	201	27	5	19
Female	2498	505	588	1201	172	21	5	6
Refused	2	1	0	1	0	0	0	0
<b>Age (years)</b>								
*	84	16	11	41	12	3	0	1
1-4	263	96	74	88	4	0	0	1
5-11	348	115	107	120	6	0	0	0
12-17	326	82	83	144	15	2	0	0
18-64	2972	524	723	1420	252	34	6	13
> 64	670	88	110	365	84	9	4	10
<b>Race</b>								
White	3774	641	879	1868	324	36	8	18
Black	463	167	115	150	19	5	2	5
Asian	77	11	15	39	8	3	0	1
Some Others	96	26	29	32	1	1	0	0
Hispanic	193	68	61	55	7	2	0	0
Refused	60	8	9	34	7	1	0	1
<b>Hispanic</b>								
No	4244	799	988	2035	345	43	9	25
Yes	347	106	107	110	21	3	0	0
DK	26	8	3	11	2	1	1	0
Refused	46	8	10	22	5	1	0	0
<b>Employment</b>								
*	926	290	267	342	24	2	0	1
Full Time	2017	291	486	1018	184	27	2	9
Part Time	379	82	82	177	34	1	0	3
Not Employed	1309	256	263	626	127	18	8	11
Refused	32	2	10	15	4	0	0	1
<b>Education</b>								
*	1021	314	285	384	31	4	0	3
< High School	399	110	91	162	20	6	2	8
High School Graduate	1253	269	302	591	69	12	3	7
< College	895	130	223	438	93	8	2	1
College Graduate	650	64	132	346	93	9	3	3
Post Graduate	445	34	75	257	67	9	0	3
<b>Census Region</b>								
Northeast	1048	236	230	484	83	8	2	5
Midwest	1036	156	249	527	86	10	2	6
South	1601	376	403	707	93	11	2	9
West	978	153	226	460	111	19	4	5
<b>Day of Week</b>								
Weekday	3156	631	765	1458	248	33	5	16
Weekend	1507	290	343	720	125	15	5	9
<b>Season</b>								
Winter	1264	268	309	557	105	15	2	8
Spring	1181	217	286	560	96	12	3	7
Summer	1275	251	312	596	94	13	1	8
Fall	943	185	201	465	78	8	4	2
<b>Asthma</b>								
No	4287	821	1013	2030	351	39	10	23
Yes	341	95	88	133	17	7	0	1
DK	35	5	7	15	5	2	0	1
<b>Angina</b>								
No	4500	892	1080	2098	352	44	10	24
Yes	125	21	23	63	16	2	0	0
DK	38	8	5	17	5	2	0	1
<b>Bronchitis/emphysema</b>								
No	4424	871	1064	2063	349	44	9	24
Yes	203	45	39	99	17	2	1	0
DK	36	5	5	16	7	2	0	1

Note: \* Signifies missing data; DK = respondent answered don't know; N = sample size; Refused = respondent refused to answer.  
 Source: Tsang and Klepeis, 1996



Table 15-52. Number of Days Since the Floor Area in the Home Was Swept or Vacuumed by the Number of Respondents

	Number of Days since That Area Was Swept-vacuumed														
	Total N	0	Swept-Vacuumed Yes/day	1	2	3	4	5	6	7	8	10	14	>2 Weeks	Dk
<b>Overall</b>	9386	8112	550	278	189	85	63	31	17	26	2	1	5	16	11
<b>Gender</b>															
Male	4294	3688	245	136	100	35	37	19	8	10	1	0	3	7	5
Female	5088	4421	304	142	89	50	26	12	9	16	1	1	2	9	6
Refused	4	3	1	0	0	0	0	0	0	0	0	0	0	0	0
<b>Age (years)</b>															
*	187	180	1	0	3	1	0	0	0	0	0	0	0	1	1
1-4	499	67	199	93	54	24	19	17	9	7	0	1	2	6	1
5-11	703	393	121	70	50	23	22	8	2	4	1	0	2	2	5
12-17	589	533	30	12	6	3	0	0	1	2	0	0	0	2	0
18-64	6059	5592	198	102	76	34	22	6	5	13	1	0	1	5	4
> 64	1349	1347	1	1	0	0	0	0	0	0	0	0	0	0	0
<b>Race</b>															
White	7591	6586	398	232	152	72	55	29	14	24	2	1	5	13	8
Black	945	825	72	18	17	7	3	1	2	0	0	0	0	0	0
Asian	157	138	5	6	2	2	1	0	0	1	0	0	0	1	1
Some Others	182	141	21	7	9	2	1	0	0	0	0	0	0	1	0
Hispanic	385	300	52	15	9	2	2	0	1	1	0	0	0	1	2
Refused	126	122	2	0	0	0	1	1	0	0	0	0	0	0	0
<b>Hispanic</b>															
No	8534	7421	460	248	170	80	57	29	15	24	2	1	5	14	8
Yes	702	549	88	29	17	5	4	2	2	2	0	0	0	1	3
Dk	47	42	1	1	1	0	1	0	0	0	0	0	0	1	0
Refused	103	100	1	0	1	0	1	0	0	0	0	0	0	0	0
<b>Employment</b>															
*	1773	974	349	175	112	50	41	25	12	13	1	1	4	9	7
Full Time	4096	3826	96	64	50	21	18	6	4	6	1	0	0	4	0
Part Time	802	741	28	10	8	6	2	0	0	4	0	0	1	1	1
Not Employed	2644	2502	77	29	18	8	2	0	1	3	0	0	0	1	3
Refused	71	69	0	0	1	0	0	0	0	0	0	0	0	1	0
<b>Education</b>															
*	1968	1162	353	175	114	50	41	25	12	13	1	1	4	10	7
< High School	834	793	24	13	2	1	0	0	0	0	0	0	0	0	1
High School Graduate	2612	2447	76	39	26	9	7	1	2	0	1	0	0	2	2
< College	1801	1681	55	25	18	10	6	0	1	3	0	0	0	2	0
College Graduate	1247	1155	28	19	17	10	5	3	1	7	0	0	0	1	1
Post Graduate	924	874	14	7	12	5	4	2	1	3	0	0	1	1	0
<b>Census Region</b>															
Northeast	2075	1793	129	65	35	18	4	9	9	6	0	0	0	5	2
Midwest	2102	1826	108	59	47	21	17	7	2	6	2	1	2	2	2
South	3243	2805	193	87	75	26	27	8	3	8	0	0	2	5	4
West	1966	1688	120	67	32	20	15	7	3	6	0	0	1	4	3
<b>Day of Week</b>															
Weekday	6316	5487	366	160	125	57	51	18	13	15	2	1	4	11	6
Weekend	3070	2625	184	118	64	28	12	13	4	11	0	0	1	5	5
<b>Season</b>															
Winter	2524	2144	162	79	61	27	17	7	3	13	0	0	1	5	5
Spring	2438	2112	121	90	48	19	19	9	7	4	0	0	2	5	2
Summer	2536	2187	167	68	41	26	19	12	3	3	0	1	2	4	3
Fall	1888	1669	100	41	39	13	8	3	4	6	2	0	0	2	1
<b>Asthma</b>															
No	8629	7455	502	262	171	80	59	30	13	22	2	1	5	16	11
Yes	694	596	48	15	17	5	4	1	4	4	0	0	0	0	0
Dk	63	61	0	1	1	0	0	0	0	0	0	0	0	0	0
<b>Angina</b>															
No	9061	7793	547	277	189	83	63	31	17	26	2	1	5	16	11
Yes	250	246	2	1	0	1	0	0	0	0	0	0	0	0	0
Dk	75	73	1	0	0	1	0	0	0	0	0	0	0	0	0
<b>Bronchitis/emphysema</b>															
No	8882	7645	536	268	182	84	61	31	17	25	2	1	5	15	10
Yes	433	397	13	10	7	1	2	0	0	1	0	0	0	1	1
Dk	71	70	1	0	0	0	0	0	0	0	0	0	0	0	0

Note: \* Signifies missing data; DK = respondents answered don't know; N= sample size; Refused = respondent refused to answer.  
Source: Tsang and Klepeis, 1996



Table 15-53. Number of Loads of Laundry Washed in a Washing Machine at Home by the Number of Respondents

	Total N	Number of Loads/Day											
		1	2	3	4	5	6	7	8	9	10	>10	DK
<b>Overall</b>	1762	582	604	303	123	55	27	11	12	1	5	1	38
<b>Gender</b>													
Male	678	219	241	120	41	17	8	*	*	1	1	*	30
Female	1083	363	363	183	82	38	19	10	12	*	4	1	8
Refused	1	*	*	*	*	*	*	1	*	*	*	*	*
<b>Age (years)</b>													
*	30	9	14	2	3	1	*	*	*	*	*	*	1
1-4	109	29	36	24	12	5	2	*	*	*	1	*	*
5-11	141	38	55	28	8	6	2	1	*	1	*	*	1
12-17	127	39	52	22	10	1	1	*	1	*	*	*	1
18-64	1161	385	376	209	80	35	22	9	11	*	3	1	30
> 64	194	82	71	18	10	7	*	1	*	*	*	*	5
<b>Race</b>													
White	1511	513	519	254	101	48	23	11	12	1	3	*	26
Black	112	27	41	23	11	4	1	*	*	*	1	*	4
Asian	22	7	4	3	5	*	*	*	*	*	*	*	3
Some Others	31	8	12	5	1	1	*	*	*	*	*	*	3
Hispanic	68	18	24	15	5	2	2	*	*	*	1	*	1
Refused	18	9	4	3	*	*	*	*	*	*	*	1	1
<b>Hispanic</b>													
No	1615	536	556	271	115	50	24	11	12	1	4	*	35
Yes	126	38	42	26	8	5	3	*	*	*	1	*	3
DK	6	*	2	4	*	*	*	*	*	*	*	*	*
Refused	15	8	4	2	*	*	*	*	*	*	*	1	*
<b>Employment</b>													
*	369	102	143	71	29	12	5	1	1	1	2	*	2
Full Time	734	259	244	128	42	20	10	5	4	*	2	*	20
Part Time	160	58	53	23	10	8	3	*	1	*	*	*	4
Not Employed	482	158	158	79	41	15	8	5	6	*	1	1	10
Refused	17	5	6	2	1	*	1	*	*	*	*	*	2
<b>Education</b>													
*	413	118	160	77	32	12	6	1	1	1	2	*	3
< High School	133	44	44	22	10	4	3	2	*	*	*	*	4
High School Graduate	508	175	166	85	35	18	8	3	4	*	*	*	14
< College	321	105	101	61	25	9	3	2	5	*	2	1	7
College Graduate	212	83	68	32	11	8	4	*	1	*	*	*	5
Post Graduate	175	57	65	26	10	4	3	3	1	*	1	*	5
<b>Census Region</b>													
Northeast	367	111	146	57	23	13	7	2	1	*	*	*	7
Midwest	406	125	123	76	42	14	5	3	6	1	*	1	10
South	628	205	228	110	39	17	6	6	4	*	3	*	10
West	361	141	107	60	19	11	9	*	1	*	2	*	11
<b>Day of Week</b>													
Weekday	1172	418	409	194	62	29	17	7	7	1	1	1	26
Weekend	590	164	195	109	61	26	10	4	5	*	4	*	12
<b>Season</b>													
Winter	458	154	159	73	31	14	6	3	4	1	3	1	9
Spring	465	154	159	87	28	10	10	3	2	*	1	*	11
Summer	482	158	166	85	38	11	8	4	3	*	1	*	8
Fall	357	116	120	58	26	20	3	1	3	*	*	*	10
<b>Asthma</b>													
No	1615	548	545	274	105	50	27	11	12	1	5	1	36
Yes	140	31	56	28	18	5	*	*	*	*	*	*	2
DK	7	3	3	1	*	*	*	*	*	*	*	*	*
<b>Angina</b>													
No	1710	564	592	294	113	54	26	11	12	1	5	1	37
Yes	40	14	9	7	8	1	1	*	*	*	*	*	*
DK	12	4	3	2	2	*	*	*	*	*	*	*	1
<b>Bronchitis/Emphysema</b>													
No	1658	544	572	285	112	53	26	10	12	1	5	1	37
Yes	96	36	28	16	11	2	1	1	*	*	*	*	1
DK	8	2	4	2	*	*	*	*	*	*	*	*	*

Note: \* Signifies missing data; "DK" = respondent answered don't know; N= sample size; Refused = respondent refused to answer.  
Source: Tsang And Klepeis, 1996



Table 15-54. Number of Times Using a Dishwasher at Specified Frequencies by the Number of Respondents							
	Total N	Number of Times/Week					DK
		*	Almost Every Day	3-5/Week	1-2/Week	<1-2/Week	
Overall	2635	1	557	678	529	824	46
<b>Gender</b>							
Male	1235	*	259	282	247	417	30
Female	1399	1	298	396	282	406	16
Refused	1	*	*	*	*	1	*
<b>Age (years)</b>							
*	35	*	4	13	11	6	1
1-4	145	*	9	4	3	118	11
5-11	211	*	14	8	15	157	17
12-17	206	*	27	33	31	113	2
18-64	1718	*	438	512	397	360	11
> 64	320	1	65	108	72	70	4
<b>Race</b>							
White	2267	1	504	603	487	637	35
Black	163	*	19	32	19	90	3
Asian	54	*	7	8	7	31	1
Some Others	45	*	9	8	1	24	3
Hispanic	84	*	13	15	12	40	4
Refused	22	*	5	12	3	2	*
<b>Hispanic</b>							
No	2444	1	524	635	504	739	41
Yes	164	*	27	32	21	79	5
DK	11	*	2	2	2	5	*
Refused	16	*	4	9	2	1	*
<b>Employment</b>							
*	552	*	49	45	46	382	30
Full Time	1191	*	276	359	298	249	9
Part Time	204	*	48	70	46	38	2
Not Employed	678	1	181	200	136	155	5
Refused	10	*	3	4	3	*	*
<b>Education</b>							
*	593	*	55	51	55	400	32
< High School	124	1	29	27	26	41	*
High School Graduate	582	*	153	173	114	132	10
< College	560	*	144	181	117	117	1
College Graduate	446	*	105	134	126	80	1
Post Graduate	330	*	71	112	91	54	2
<b>Census Region</b>							
Northeast	538	*	133	144	95	159	7
Midwest	514	*	116	130	110	152	6
South	953	*	200	251	169	312	21
West	630	1	108	153	155	201	12
<b>Day of Week</b>							
Weekday	1768	1	378	466	341	549	33
Weekend	867	*	179	212	188	275	13
<b>Season</b>							
Winter	711	*	144	175	149	223	20
Spring	664	1	122	181	132	214	14
Summer	721	*	157	185	134	239	6
Fall	539	*	134	137	114	148	6
<b>Asthma</b>							
No	2439	1	521	622	492	765	38
Yes	189	*	35	54	35	58	7
DK	7	*	1	2	2	1	1
<b>Angina</b>							
No	2570	1	538	664	512	809	46
Yes	60	*	19	11	16	14	*
DK	5	*	*	3	1	1	*
<b>Bronchitis/Emphysema</b>							
No	2533	1	540	646	504	796	46
Yes	93	*	16	27	23	27	*
DK	9	*	1	5	2	1	*

Note: \* Signifies missing data; "DK" = respondent answered don't know; N= sample size; Refused = respondent refused to answer.  
 Source: Tsang And Klepeis, 1996



Table 15-55. Number of Times Washing Dishes by Hand at Specified Frequencies by the Number of Respondents							
	Total N	Number of Times/Week					
		*	Almost Every Day	3-5/Week	1-2/Week	<1-2/Week	DK
<b>Overall</b>	3626	1	2600	490	326	197	12
<b>Gender</b>							
Male	1554	*	982	264	183	117	8
Female	2071	1	1618	225	143	80	4
Refused	1	*	*	1	*	*	*
<b>Age (years)</b>							
*	65	*	51	6	2	6	*
1-4	1	*	*	*	1	*	*
5-11	103	*	12	14	33	44	*
12-17	228	*	57	45	69	56	1
18-64	2642	1	1979	379	201	76	6
> 64	587	*	501	46	20	15	5
<b>Race</b>							
White	2928	1	2114	391	257	157	8
Black	385	*	261	61	40	21	2
Asian	61	*	48	6	3	4	*
Some Others	67	*	44	9	9	5	*
Hispanic	147	*	108	17	12	8	2
Refused	38	*	25	6	5	2	*
<b>Hispanic</b>							
No	3322	1	2383	454	296	178	10
Yes	258	*	185	32	25	14	2
DK	21	*	16	*	3	2	*
Refused	25	*	16	4	2	3	*
<b>Employment</b>							
*	328	*	71	57	102	97	1
Full Time	1765	*	1282	284	145	50	4
Part Time	349	*	270	44	17	15	3
Not Employed	1165	1	965	104	60	31	4
Refused	19	*	12	1	2	4	*
<b>Education</b>							
*	386	*	101	65	107	112	1
< High School	354	*	298	26	15	12	3
High School Graduate	1106	1	856	140	74	30	5
< College	796	*	606	116	57	16	1
College Graduate	591	*	445	86	47	13	*
Post Graduate	393	*	294	57	26	14	2
<b>Census Region</b>							
Northeast	832	*	636	90	60	43	3
Midwest	811	*	569	114	81	45	2
South	1214	1	840	175	124	70	4
West	769	*	555	111	61	39	3
<b>Day of Week</b>							
Weekday	2474	*	1759	335	236	136	8
Weekend	1152	1	841	155	90	61	4
<b>Season</b>							
Winter	985	*	691	138	90	63	3
Spring	902	1	648	117	85	46	5
Summer	987	*	705	132	92	55	3
Fall	752	*	556	103	59	33	1
<b>Asthma</b>							
No	3345	1	2407	455	290	183	9
Yes	263	*	179	33	34	14	3
DK	18	*	14	2	2	*	*
<b>Angina</b>							
No	3501	*	2499	475	321	194	12
Yes	105	1	86	11	5	2	*
DK	20	*	15	4	*	1	*
<b>Bronchitis/Emphysema</b>							
No	3438	1	2459	460	314	192	12
Yes	169	*	126	27	11	5	*
DK	19	*	15	3	1	*	*

Note: \* Signifies missing data; "DK" = respondent answered don't know; N= sample size; Refused = respondent refused to answer.  
 Source: Tsang And Klepeis, 1996





Table 15-56. Number of Times for Washing Clothes in a Washing Machine at Specified Frequencies by the Number of Respondents								
	Total N	Number of Times/Week						DK
		*	Almost Every Day	3-5 /Day	1-2/week	<1/week	Never	
<b>Overall</b>	4663	404	566	1033	1827	331	465	37
<b>Gender</b>								
Male	2163	212	211	458	811	154	300	17
Female	2498	191	355	575	1015	177	165	20
Refused	2	1	*	*	1	*	*	*
<b>Age (years)</b>								
*	84	3	6	11	47	3	2	12
1-4	263	261	*	*	*	*	1	1
5-11	348	101	2	4	16	15	206	4
12-17	326	1	22	29	83	67	124	*
18-64	2972	31	489	832	1328	197	83	12
> 64	670	7	47	157	353	49	49	8
<b>Race</b>								
White	3774	316	499	883	1445	246	370	15
Black	463	39	33	72	207	52	55	5
Asian	77	4	1	12	39	13	8	*
Some Others	96	16	10	15	36	8	11	*
Hispanic	193	29	19	41	77	10	17	*
Refused	60	*	4	10	23	2	4	17
<b>Hispanic</b>								
No	4244	342	528	950	1674	307	424	19
Yes	347	59	31	69	130	20	38	*
DK	26	2	3	6	10	3	2	*
Refused	46	1	4	8	13	1	1	18
<b>Employment</b>								
*	926	366	23	32	97	76	327	5
Full Time	2017	21	305	569	929	119	66	8
Part Time	379	6	64	101	166	29	13	*
Not Employed	1309	10	170	326	628	105	58	12
Refused	32	1	4	5	7	2	1	12
<b>Education</b>								
*	1021	367	33	37	129	89	343	23
< High School	399	3	61	88	178	40	27	2
High School Graduate	1253	14	218	367	548	55	47	4
< College	895	3	126	261	432	51	19	3
College Graduate	650	12	78	171	321	57	9	2
Post Graduate	445	5	50	109	219	39	20	3
<b>Census Region</b>								
Northeast	1048	84	119	216	454	81	87	7
Midwest	1036	88	108	229	408	78	121	4
South	1601	147	229	376	557	97	182	13
West	978	85	110	212	408	75	75	13
<b>Day of Week</b>								
Weekday	3156	257	407	697	1217	232	320	26
Weekend	1507	147	159	336	610	99	145	11
<b>Season</b>								
Winter	1264	121	157	273	472	101	129	11
Spring	1181	122	135	259	464	82	113	6
Summer	1275	102	163	280	484	88	142	16
Fall	943	59	111	221	407	60	81	4
<b>Asthma</b>								
No	4287	371	522	951	1700	303	421	19
Yes	341	32	42	79	118	26	43	1
DK	35	1	2	3	9	2	1	17
<b>Angina</b>								
No	4500	403	555	993	1759	321	451	18
Yes	125	*	8	37	58	7	13	2
DK	38	1	3	3	10	3	1	17
<b>Bronchitis/emphysema</b>								
No	4424	397	549	979	1724	315	441	19
Yes	203	7	15	51	92	14	23	1
DK	36	*	2	3	11	2	1	17

Note: \* Signifies missing data; "DK" = respondent answered don't know; N= sample size; Refused = respondent refused to answer.  
Source: Tsang And Klepeis, 1996



Table 15-57. Number of Minutes Spent Playing on Sand or Gravel in a Day by the Number of Respondents

	Total N	Minutes/Day												
		*.*	0-0	0-10	10-20	20-30	30-40	40-50	50-60	70-80	80-90	90-100	110-120	121
<b>Overall</b>	700	41	348	42	34	57	4	12	66	2	9	2	27	56
<b>Gender</b>														
Male	352	18	189	20	13	25	*	7	32	*	7	1	10	30
Female	347	23	158	22	21	32	4	5	34	2	2	1	17	26
Refused	1	*	1	*	*	*	*	*	*	*	*	*	*	*
<b>Age (years)</b>														
*	3	1	*	*	1	*	*	*	*	*	*	*	*	1
1-4	216	13	115	15	9	15	2	3	15	1	5	*	7	16
5-11	200	7	96	11	12	14	*	5	25	1	2	1	6	20
12-17	41	1	23	1	2	4	*	3	3	*	1	1	3	3
18-64	237	18	112	15	10	24	2	4	23	*	2	*	11	16
> 64	3	1	2	*	*	*	*	*	*	*	*	*	*	*
<b>Race</b>														
White	568	34	274	37	30	49	2	9	57	1	8	2	21	44
Black	68	4	42	5	3	2	*	1	4	*	*	*	3	4
Asian	5	*	2	*	*	1	*	*	1	*	*	*	*	1
Some Others	16	2	9	*	*	*	2	*	1	*	*	*	*	3
Hispanic	41	*	19	*	1	5	*	2	3	1	1	*	3	4
Refused	2		2	*	*	*	*	*	*	*	*	*	*	*
<b>Hispanic</b>														
No	619	36	309	41	29	49	4	10	59	1	7	2	23	49
Yes	77	5	36	1	4	8	*	2	7	1	2	*	4	7
DK	3	*	2	*	1	*	*	*	*	*	*	*	*	*
Refused	1	*	1	*	*	*	*	*	*	*	*	*	*	*
<b>Employment</b>														
*	461	22	234	27	24	33	2	8	43	2	7	2	16	41
Full Time	149	9	73	7	7	16	1	3	17	*	2	*	6	8
Part Time	29	2	10	4	1	2	1	*	4	*	*	*	2	3
Not Employed	60	7	31	4	2	6	*	1	2	*	*	*	3	4
Refused	1	1	*	*	*	*	*	*	*	*	*	*	*	*
<b>Education</b>														
*	461	22	234	27	24	33	2	8	43	2	7	2	16	41
< High School	22	5	9	*	*	3	*	*	1	*	*	*	2	2
High School Graduate	73	4	39	4	1	8	1	*	6	*	1	*	2	7
< College	66	2	34	6	2	6	*	2	6	*	*	*	4	4
College Graduate	54	4	26	3	3	6	1	2	7	*	*	*	*	2
Post Graduate	24	4	6	2	4	1	*	*	3	*	1	*	3	*
<b>Census Region</b>														
Northeast	124	8	60	8	5	7	*	4	16	*	1	*	6	9
Midwest	128	6	69	8	6	14	*	2	11	*	2	*	3	7
South	273	17	133	18	12	25	3	3	30	*	3	2	6	21
West	175	10	86	8	11	11	1	3	9	2	3	*	12	19
<b>Day of Week</b>														
Weekday	445	35	216	27	22	40	3	10	37	2	6	2	17	28
Weekend	255	6	132	15	12	17	1	2	29	*	3	*	10	28
<b>Season</b>														
Winter	107	10	44	9	6	11	1	2	8	2	1	*	4	9
Spring	240	8	113	21	14	22	1	3	25	*	2	*	12	19
Summer	262	12	146	5	9	20	2	5	25	*	5	2	9	22
Fall	91	11	45	7	5	4	*	2	8	*	1	*	2	6
<b>Asthma</b>														
No	638	38	319	39	34	51	4	10	57	2	9	2	22	51
Yes	61	3	28	3	*	6	*	2	9	*	*	*	5	5
DK	1	*	1	*	*	*	*	*	*	*	*	*	*	*
<b>Angina</b>														
No	699	40	348	42	34	57	4	12	66	2	9	2	27	56
DK	1	1	*	*	*	*	*	*	*	*	*	*	*	*
<b>Bronchitis/Emphyseme</b>														
No	679	41	339	41	34	54	4	12	62	2	9	2	26	53
Yes	21	*	9	1	*	3	*	*	4	*	*	*	1	3

Note: "\*" = Signifies missing data. "DK" = Don't know. Refused = refused to answer. N = Doer sample size in specified range of number of minutes spent. A value of "121" for number of minutes signifies that more than 120 minutes were spent. Source: Tsang and Klepeis, 1996.



Table 15-58. Number of Minutes Spent Playing in Sand or Gravel (minutes/day)

Category	Population Group	N	Percentiles											
			1	2	5	10	25	50	75	90	95	98	99	100
Overall		659	0	0	0	0	0	0	45	120	121	121	121	121
Gender	Male	334	0	0	0	0	0	0	45	120	121	121	121	121
Gender	Female	324	0	0	0	0	0	1	60	120	121	121	121	121
Age (years)	1-4	203	0	0	0	0	0	0	30	120	121	121	121	121
Age (years)	5-11	193	0	0	0	0	0	3	60	121	121	121	121	121
Age (years)	12-17	40	0	0	0	0	0	0	45	120	121	121	121	121
Age (years)	18-64	219	0	0	0	0	0	0	45	120	121	121	121	121
Age (years)	> 64	2	0	0	0	0	0	0	0	0	0	0	0	0
Race	White	534	0	0	0	0	0	0	50	120	121	121	121	121
Race	Black	64	0	0	0	0	0	0	15	120	121	121	121	121
Race	Asian	5	0	0	0	0	0	30	60	121	121	121	121	121
Race	Some Others	15	0	0	0	0	0	0	60	121	121	121	121	121
Race	Hispanic	39	0	0	0	0	0	15	60	121	121	121	121	121
Hispanic	No	583	0	0	0	0	0	0	45	120	121	121	121	121
Hispanic	Yes	72	0	0	0	0	0	1.5	60	120	121	121	121	121
Employment	Full Time	140	0	0	0	0	0	0	45	105	121	121	121	121
Employment	Part Time	27	0	0	0	0	0	10	60	121	121	121	121	121
Employment	Not Employed	53	0	0	0	0	0	0	30	120	121	121	121	121
Education	< High School	17	0	0	0	0	0	0	60	121	121	121	121	121
Education	High School Graduate	69	0	0	0	0	0	0	30	121	121	121	121	121
Education	< College	64	0	0	0	0	0	0	37.5	120	121	121	121	121
Education	College Graduate	50	0	0	0	0	0	0	30	60	60	121	121	121
Education	Post Graduate	20	0	0	0	0	0	15	60	120	120	120	120	120
Census Region	Northeast	116	0	0	0	0	0	0	60	120	121	121	121	121
Census Region	Midwest	122	0	0	0	0	0	0	30	60	121	121	121	121
Census Region	South	256	0	0	0	0	0	0	45	120	121	121	121	121
Census Region	West	165	0	0	0	0	0	0	60	121	121	121	121	121
Day of Week	Weekday	410	0	0	0	0	0	0	40	120	121	121	121	121
Day of Week	Weekend	249	0	0	0	0	0	0	60	121	121	121	121	121
Season	Winter	97	0	0	0	0	0	5	45	120	121	121	121	121
Season	Spring	232	0	0	0	0	0	1	52.5	120	121	121	121	121
Season	Summer	250	0	0	0	0	0	0	60	120	121	121	121	121
Season	Fall	80	0	0	0	0	0	0	30	105	121	121	121	121
Asthma	No	600	0	0	0	0	0	0	45	120	121	121	121	121
Asthma	Yes	58	0	0	0	0	0	3	60	120	121	121	121	121
Angina	No	659	0	0	0	0	0	0	45	120	121	121	121	121
Bronch/emphys	No	638	0	0	0	0	0	0	45	120	121	121	121	121
Bronch/emphys	Yes	21	0	0	0	0	0	30	60	121	121	121	121	121

NOTE: A value of "121" for number of minutes signifies that more than 120 minutes were spent. N = doer sample size. Percentiles are the percentage of doers below or equal to a given number of minutes.  
Source: Tsang and Klepeis, 1996



Table 15-59. Number of Minutes Spent Playing in Outdoors on Sand, Gravel, Dirt, or Grass When Fill Dirt Was Present by the Number of Respondents

	Total N	Minutes/Day											
		*_*	0-0	0-10	10-20	20-30	30-40	40-50	50-60	70-80	80-90	110-120	121
<b>Overall</b>	700	53	380	51	29	48	1	6	60	7	1	21	43
<b>Gender</b>													
Male	352	26	183	22	18	33	*	3	24	5	1	16	21
Female	347	27	196	29	11	15	1	3	36	2	*	5	22
Refused	1	*	1	*	*	*	*	*	*	*	*	*	*
<b>Age (years)</b>													
*	3	*	*	1	*	*	*	*	1	*	*	*	1
1-4	216	11	118	14	10	13	1	4	18	4	*	7	16
5-11	200	15	103	14	8	15	*	1	17	1	*	9	17
12-17	41	3	19	3	2	7	*	*	4	*	*	2	*
18-64	237	23	138	19	9	13	*	1	20	1	1	3	9
> 64	3	1	2	*	*	*	*	*	*	*	*	*	*
<b>Race</b>													
White	568	40	317	40	21	38	*	5	48	5	1	15	38
Black	68	8	33	5	2	6	*	1	7	1	*	3	2
Asian	5	*	2	*	*	2	*	*	*	*	*	*	1
Some Others	16	*	10	1	2	1	*	1	*	*	*	*	*
Hispanic	41	5	17	5	4	*	*	*	4	1	*	3	2
Refused	2	*	1	*	*	1	*	*	*	*	*	*	*
<b>Hispanic</b>													
No	619	45	345	42	21	44	1	6	54	5	1	17	38
Yes	77	8	32	9	8	3	*	*	6	2	*	4	5
DK	3	*	3	*	*	*	*	*	*	*	*	*	*
Refused	1	*	*	*	*	1	*	*	*	*	*	*	*
<b>Employment</b>													
*	461	29	240	32	20	35	1	5	40	6	*	18	35
Full Time	149	11	91	8	8	8	*	1	12	1	1	3	5
Part Time	29	4	17	3	*	2	*	*	2	*	*	*	1
Not Employed	60	8	32	8	1	3	*	*	6	*	*	*	2
Refused	1	1	*	*	*	*	*	*	*	*	*	*	*
<b>Education</b>													
*	461	29	240	32	20	35	1	5	40	6	*	18	35
< High School	22	5	9	*	*	3	*	*	2	*	*	1	2
High School Graduate	73	6	44	7	2	3	*	*	7	1	1	1	1
< College	66	4	38	7	3	3	*	1	7	*	*	*	3
College Graduate	54	3	35	3	4	4	*	*	3	*	*	*	2
Post Graduate	24	6	14	2	*	*	*	*	1	*	*	1	*
<b>Census Region</b>													
Northeast	124	6	70	13	3	5	*	*	18	1	*	2	6
Midwest	128	12	77	6	7	10	*	1	7	2	*	2	4
South	273	23	153	17	12	20	*	3	17	4	*	11	13
West	175	12	80	15	7	13	1	2	18	*	1	6	20
<b>Day of Week</b>													
Weekday	445	39	235	34	21	34	1	2	38	6	1	10	24
Weekend	255	14	145	17	8	14	*	4	22	1	*	11	19
<b>Season</b>													
Winter	107	14	51	6	6	5	*	2	7	2	*	2	12
Spring	240	10	134	17	10	20	1	2	21	2	*	10	13
Summer	262	17	143	19	12	19	*	1	25	2	1	8	15
Fall	91	12	52	9	1	4	*	1	7	1	*	1	3
<b>Asthma</b>													
No	638	48	354	47	25	41	1	5	50	7	1	19	40
Yes	61	5	25	4	4	7	*	1	10	*	*	2	3
DK	1	*	1	*	*	*	*	*	*	*	*	*	*
<b>Angina</b>													
No	699	53	380	51	29	48	1	6	60	6	1	21	43
DK	1	*	*	*	*	*	*	*	*	1	*	*	*
<b>Bronchitis/Emphysema</b>													
No	679	52	368	51	28	46	1	5	57	7	1	21	42
Yes	21	1	12	*	1	2	*	1	3	*	*	*	1

Note: "\*" Signifies missing data. "DK" = Respondents answered don't know. Refused = Respondents refused to answer. N = Doer sample size in specified range of number of minutes spent. A value of "121" for number of minutes signifies that more than 120 minutes were spent. Source: Tsang and Klepeis, 1996.



Table 15-60. Number of Minutes Spent Playing on Sand, Gravel, Dirt, or Grass When Fill Dirt Was Present (minutes/day)														
Category	Population Group	N	Percentiles											
			1	2	5	10	25	50	75	90	95	98	99	100
Overall		647	0	0	0	0	0	0	0	30	100	121	121	121
Gender	Male	326	0	0	0	0	0	0	0	30	120	121	121	121
Gender	Female	320	0	0	0	0	0	0	0	30	60	121	121	121
Age (years)	1-4	205	0	0	0	0	0	0	0	30	120	121	121	121
Age (years)	5-11	185	0	0	0	0	0	0	0	30	120	121	121	121
Age (years)	12-17	38	0	0	0	0	0	0.5	30	60	120	120	120	120
Age (years)	18-64	214	0	0	0	0	0	0	15	60	120	121	121	121
Age (years)	> 64	2	0	0	0	0	0	0	0	0	0	0	0	0
Race	White	528	0	0	0	0	0	0	30	120	121	121	121	121
Race	Black	60	0	0	0	0	0	0	30	74	120	121	121	121
Race	Asian	5	0	0	0	0	0	30	30	121	121	121	121	121
Race	Some Others	16	0	0	0	0	0	0	20	40	60	60	60	60
Race	Hispanic	36	0	0	0	0	0	1	60	120	121	121	121	121
Hispanic	No	574	0	0	0	0	0	0	30	90	121	121	121	121
Hispanic	Yes	69	0	0	0	0	0	1	30	120	121	121	121	121
Employment	Full Time	138	0	0	0	0	0	0	15	60	120	121	121	121
Employment	Part Time	25	0	0	0	0	0	0	10	60	60	121	121	121
Employment	Not Employed	52	0	0	0	0	0	0	10	60	60	121	121	121
Education	< High School	17	0	0	0	0	0	0	60	121	121	121	121	121
Education	High School Graduate	67	0	0	0	0	0	0	10	60	88	120	121	121
Education	< College	62	0	0	0	0	0	0	15	60	60	121	121	121
Education	College Graduate	51	0	0	0	0	0	0	15	30	60	121	121	121
Education	Post Graduate	18	0	0	0	0	0	0	60	120	120	120	120	120
Census Region	Northeast	118	0	0	0	0	0	0	30	60	121	121	121	121
Census Region	Midwest	116	0	0	0	0	0	0	20	60	120	121	121	121
Census Region	South	250	0	0	0	0	0	0	30	90	121	121	121	121
Census Region	West	163	0	0	0	0	0	1	60	121	121	121	121	121
Day of Week	Weekday	406	0	0	0	0	0	0	30	88	121	121	121	121
Day of Week	Weekend	241	0	0	0	0	0	0	30	120	121	121	121	121
Season	Winter	93	0	0	0	0	0	0	45	121	121	121	121	121
Season	Spring	230	0	0	0	0	0	0	30	105	121	121	121	121
Season	Summer	245	0	0	0	0	0	0	30	90	121	121	121	121
Season	Fall	79	0	0	0	0	0	0	10	60	120	121	121	121
Asthma	No	590	0	0	0	0	0	0	30	110	121	121	121	121
Asthma	Yes	56	0	0	0	0	0	10	60	60	121	121	121	121
Angina	No	646	0	0	0	0	0	0	30	100	121	121	121	121
Bronchitis/Emphysema	No	627	0	0	0	0	0	0	30	120	121	121	121	121
Bronchitis/Emphysema	Yes	20	0	0	0	0	0	0	37.5	60	90.5	121	121	121

NOTE: A value of "121" for number of minutes signifies that more than 120 minutes were spent. N = doer sample size. Percentiles are the percentage of doers below or equal to a given number of minutes.  
Source: Tsang and Klepeis, 1996



Table 15-61. Range of the Time Spent Working in a Garden or Other Circumstances in a Month by the Number of Respondents																	
	Total N	Hours/Month															
		*-*	0-0	0-24	24-48	48-72	72-96	96-120	120-144	144-168	168-192	192-216	216-240	240-264	264-288	288-312	312-336
<b>Overall</b>	4663	91	2928	1312	145	81	28	23	1	10	5	12	8	3	1	1	14
<b>Gender</b>																	
Male	2163	38	1309	628	77	41	16	9	1	8	4	10	8	2	1	*	11
Female	2498	53	1618	683	68	40	12	14	*	2	1	2	*	1	*	1	3
Refused	2	*	1	1	*	*	*	*	*	*	*	*	*	*	*	*	*
<b>Age (years)</b>																	
*	84	11	51	17	*	2	2	1	*	*	*	*	*	*	*	*	*
1-4	263	7	189	55	4	3	2	2	*	1	*	*	*	*	*	*	*
5-11	348	7	225	100	9	4	*	*	*	1	*	*	*	*	1	*	1
12-17	326	5	236	75	6	1	*	1	*	*	1	*	*	*	*	*	*
18-64	2972	37	1813	900	97	52	16	16	1	7	1	8	8	3	*	*	13
> 64	670	24	414	165	29	19	8	3	*	2	2	3	*	*	*	1	*
<b>Race</b>																	
White	3774	59	2303	1128	127	69	22	21	1	7	4	11	7	3	1	1	10
Black	463	9	351	77	9	8	3	*	*	2	1	*	*	*	*	*	2
Asian	77	1	50	25	1	*	*	*	*	*	*	*	*	*	*	*	*
Some Others	96	2	64	23	2	2	1	*	*	1	*	*	*	*	*	*	*
Hispanic	193	6	126	50	5	1	2	1	*	*	*	*	*	*	*	*	2
Refused	60	14	34	9	1	1	*	1	*	*	*	*	*	*	*	*	*
<b>Hispanic</b>																	
No	4244	65	2669	1206	135	73	25	20	1	8	5	12	8	3	1	1	12
Yes	347	11	218	94	9	6	3	3	*	1	*	*	*	*	*	*	2
DK	26	1	18	5	1	1	*	*	*	1	*	*	*	*	*	*	*
Refused	46	14	23	7	1	1	*	*	*	*	*	*	*	*	*	*	*
<b>Employment</b>																	
*	926	19	638	230	20	8	2	3	*	1	2	1	*	*	1	*	1
Full Time	2017	18	1235	600	68	35	12	9	1	7	1	10	8	2	*	*	11
Part Time	379	4	234	120	9	3	2	4	*	2	*	*	*	*	*	*	1
Not Employed	1309	39	808	354	48	35	12	7	*	*	2	1	*	1	*	1	1
Refused	32	11	13	8	*	*	*	*	*	*	*	*	*	*	*	*	*
<b>Education</b>																	
*	1021	34	699	246	22	8	3	3	*	1	2	1	*	*	1	*	1
< High School	399	18	263	86	11	9	4	4	*	1	1	*	*	*	*	*	2
High School	1253	25	770	355	41	22	9	7	*	5	2	8	4	*	*	1	4
Graduate	895	11	545	265	33	18	6	3	*	1	*	2	4	3	*	*	4
< College	650	1	406	200	19	12	3	5	*	1	1	*	*	*	*	*	2
College Graduate	445	2	245	160	19	12	3	1	1	1	*	*	*	*	*	*	1
<b>Census Region</b>																	
Northeast	1048	17	714	259	24	12	4	8	*	3	*	2	1	*	1	*	3
Midwest	1036	23	687	273	19	18	5	3	*	*	*	3	*	3	*	*	2
South	1601	35	989	446	64	26	11	7	1	4	4	3	6	*	*	1	4
West	978	16	538	334	38	25	8	5	*	3	1	4	1	*	*	*	5
<b>Day of Week</b>																	
Weekday	3156	62	1982	890	96	54	18	15	1	8	3	6	7	2	*	1	11
Weekend	1507	29	946	422	49	27	10	8	*	2	2	6	1	1	1	*	3
<b>Season</b>																	
Winter	1264	9	1038	171	20	9	5	3	*	2	2	2	*	*	*	1	2
Spring	1181	29	614	434	50	20	8	7	*	4	1	4	5	2	*	*	3
Summer	1275	39	690	421	56	33	12	9	1	2	1	3	3	1	*	*	4
Fall	943	14	586	286	19	19	3	4	*	2	1	3	*	*	1	*	5
<b>Asthma</b>																	
No	4287	70	2697	1206	135	77	27	23	1	10	5	12	6	3	1	1	13
Yes	341	6	216	101	10	4	1	*	*	*	*	2	*	*	*	*	1
DK	35	15	15	5	*	*	*	*	*	*	*	*	*	*	*	*	*
<b>Angina</b>																	
No	4500	74	2825	1277	143	77	28	21	1	10	5	12	8	3	1	1	14
Yes	125	4	86	29	1	3	*	2	*	*	*	*	*	*	*	*	*
DK	38	13	17	6	1	1	*	*	*	*	*	*	*	*	*	*	*
<b>Bronchitis/emphysema</b>																	
No	4424	72	2766	1265	140	77	27	22	1	10	5	12	8	3	1	1	14
Yes	203	5	146	43	5	2	1	1	*	*	*	*	*	*	*	*	*
DK	36	14	16	4	*	2	*	*	*	*	*	*	*	*	*	*	*

Note: \* Signifies missing data. DK = respondents answered don't know. Refused = respondents refused to answer. N = doer sample size in specified range of number of minutes spent.  
Source: Tsang and Klepeis,1996



Table 15-62. Number of Hours Spent Working with Soil in a Garden or Other Circumstances Working (hours/month)														
Category	Population Group	N	Percentiles											
			1	2	5	10	25	50	75	90	95	98	99	100
Overall		4572	0	0	0	0	0	0	3	15	40	88	160	320
Gender	Male	2125	0	0	0	0	0	0	3	20	50	150	230	320
Gender	Female	2445	0	0	0	0	0	0	2	12	30	60	90	320
Age (years)	1-4	256	0	0	0	0	0	0	1	7	20	60	120	150
Age (years)	5-11	341	0	0	0	0	0	0	2	10	20	50	60	320
Age (years)	12-17	321	0	0	0	0	0	0	1	5	10	40	60	200
Age (years)	18-64	2935	0	0	0	0	0	0	3	16	40	90	200	320
Age (years)	> 64	646	0	0	0	0	0	0	3	25	60	90	160	300
Race	White	3715	0	0	0	0	0	0	3	16	40	88	160	320
Race	Black	454	0	0	0	0	0	0	0	8	30	60	160	320
Race	Asian	76	0	0	0	0	0	0	1.5	6	15	24	40	40
Race	Some Others	94	0	0	0	0	0	0	2	15	60	150	200	200
Race	Hispanic	187	0	0	0	0	0	0	2	12	25	90	320	320
Hispanic	No	4179	0	0	0	0	0	0	3	15	40	80	180	320
Hispanic	Yes	336	0	0	0	0	0	0	2	15	32	90	120	320
Employment	Full Time	1999	0	0	0	0	0	0	4	20	45	144	240	320
Employment	Part Time	375	0	0	0	0	0	0	3	12	32	90	120	320
Employment	Not Employed	1270	0	0	0	0	0	0	3	20	45	64	100	320
Education	< High School	381	0	0	0	0	0	0	2	16	60	120	160	320
Education	High School Grad	1228	0	0	0	0	0	0	3.5	20	50	120	200	320
Education	< College	884	0	0	0	0	0	0	4	20	40	90	240	320
Education	College Grad.	649	0	0	0	0	0	0	3	16	40	70	100	320
Education	Post Grad.	443	0	0	0	0	0	0	5	20	40	61	90	320
Census Region	Northeast	1031	0	0	0	0	0	0	1	10	30	90	120	320
Census Region	Midwest	1013	0	0	0	0	0	0	2	10	30	60	120	320
Census Region	South	1566	0	0	0	0	0	0	3	18	40	90	180	320
Census Region	West	962	0	0	0	0	0	0	5	20	50	90	200	320
Day of Week	Weekday	3094	0	0	0	0	0	0	3	15	40	80	160	320
Day of Week	Weekend	1478	0	0	0	0	0	0	3	15	40	90	150	320
Season	Winter	1255	0	0	0	0	0	0	0	4	12	50	90	320
Season	Spring	1152	0	0	0	0	0	0	5	20	45	110	200	320
Season	Summer	1236	0	0	0	0	0	0	5	25	50	96	160	320
Season	Fall	929	0	0	0	0	0	0	3	10	30	88	180	320
Asthma	No	4217	0	0	0	0	0	0	3	15	40	90	160	320
Asthma	Yes	335	0	0	0	0	0	0	2	12	30	60	80	320
Angina	No	4426	0	0	0	0	0	0	3	15	40	88	160	320
Angina	Yes	121	0	0	0	0	0	0	2	7	24	60	110	120
Bronchitis/Emphysema	No	4352	0	0	0	0	0	0	3	15	40	88	180	320
Bronchitis/Emphysema	Yes	198	0	0	0	0	0	0	1	7	24	60	80	100

Note: \* Signifies missing data. DK = respondents answered don't know. Refused = respondents refused to answer. N = doer sample size. Percentiles are the percentage of doers below or equal to a given number of minutes.  
Source: Tsang and Klepeis, 1996.



Table 15-63. Range of Number of Minutes Spent Playing on Grass in a Day by the Number of Respondents

	Total N	Minutes/Day														
		*-*	0-0	0-10	10-20	20-30	30-40	40-50	50-60	60-70	70-80	80-90	90- 100	100- 110	110- 120	121- 121
<b>Overall</b>	700	43	79	49	49	85	7	11	125	1	1	21	1	2	66	160
<b>Gender</b>																
Male	352	25	35	23	25	41	3	5	64	*	1	12	*	1	33	84
Female	347	18	44	26	24	44	4	6	61	1	*	9	1	*	33	75
Refused	1	*	*	*	*	*	*	*	*	*	*	*	*	*	*	1
<b>Age (years)</b>																
*	3	*	*	1	1	*	*	*	*	*	*	*	*	*	*	1
1-4	216	10	24	19	21	25	1	4	35	*	1	8	*	1	18	49
5-11	200	15	24	10	10	19	2	3	38	1	*	8	1	*	20	49
12-17	41	2	5	1	2	8	*	1	8	*	*	1	*	*	8	5
18-64	237	16	26	18	15	32	4	3	44	*	*	4	*	1	20	54
> 64	3	*	*	*	*	1	*	*	*	*	*	*	*	*	*	2
<b>Race</b>																
White	568	36	65	40	39	58	7	9	98	1	1	17	1	1	56	139
Black	68	3	4	6	7	14	*	1	15	*	*	2	*	*	5	11
Asian	5	*	*	1	*	3	*	*	*	*	*	*	*	*	*	1
Some Others	16	*	4	*	1	1	*	*	4	*	*	1	*	*	2	3
Hispanic	41	4	5	2	2	9	*	*	8	*	*	1	*	1	3	6
Refused	2	*	1	*	*	*	*	1	*	*	*	*	*	*	*	*
<b>Hispanic</b>																
No	619	38	65	44	42	73	6	11	110	1	1	18	1	1	62	146
Yes	77	5	13	5	7	11	1	*	14	*	*	3	*	1	4	13
DK	3	*	*	*	*	1	*	*	1	*	*	*	*	*	1	1
Refused	1	*	1	*	*	*	*	*	*	*	*	*	*	*	*	*
<b>Employment</b>																
*	461	27	54	31	34	52	3	8	81	1	1	17	1	1	46	104
Full Time	149	8	16	12	10	21	3	3	25	*	*	2	*	*	13	36
Part Time	29	2	5	1	1	6	*	*	4	*	*	2	*	*	3	5
Not Employed	60	5	4	5	4	6	1	*	15	*	*	*	*	1	4	15
Refused	1	1	*	*	*	*	*	*	*	*	*	*	*	*	*	*
<b>Education</b>																
*	461	27	54	31	34	52	3	8	81	1	1	17	1	1	46	104
< High School	22	2	2	1	1	4	*	*	3	*	*	*	*	1	3	5
High School	73	4	8	9	4	6	1	1	9	*	*	3	*	*	6	22
Graduate	66	2	7	4	6	13	2	*	20	*	*	*	*	*	3	9
< College	54	3	5	3	4	6	1	1	10	*	*	*	*	*	6	15
College Graduate	24	5	3	1	*	4	*	1	2	*	*	1	*	*	2	5
Post Graduate																
<b>Census Region</b>																
Northeast	124	5	14	10	4	13	*	3	26	*	*	2	1	*	10	36
Midwest	128	8	7	10	10	15	1	3	23	*	1	4	*	*	15	31
South	273	21	22	20	25	30	5	4	52	1	*	11	*	2	23	57
West	175	9	36	9	10	27	1	1	24	*	*	4	*	*	18	36
<b>Day of Week</b>																
Weekday	445	33	55	35	32	55	3	7	82	*	1	15	1	1	38	87
Weekend	255	10	24	14	17	30	4	4	43	1	*	6	*	1	28	73
<b>Season</b>																
Winter	107	12	22	6	6	15	2	*	15	*	*	5	*	*	5	19
Spring	240	9	23	16	13	28	1	5	49	*	*	7	1	1	26	61
Summer	262	12	20	20	18	36	2	5	48	1	*	7	*	1	29	63
Fall	91	10	14	7	12	6	2	1	13	*	1	2	*	*	6	17
<b>Asthma</b>																
No	638	38	73	46	44	78	7	9	114	1	1	18	1	2	60	146
Yes	61	5	6	3	5	7	*	2	10	*	*	3	*	*	6	14
DK	1	*	*	*	*	*	*	*	1	*	*	*	*	*	*	*
<b>Angina</b>																
No	699	43	79	49	48	85	7	11	125	1	1	21	1	2	66	160
DK	1	*	*	*	1	*	*	*	*	*	*	*	*	*	*	*
<b>Bronchitis/emphysema</b>																
No	679	43	76	49	47	83	7	11	120	1	1	20	1	2	65	153
Yes	21	*	3	*	2	2	*	*	5	*	*	1	*	*	1	7

NOTE: A value of "121" for number of minutes signifies that more than 120 minutes were spent. N = doer sample size. Percentiles are the percentage of doers below or equal to a given number of minutes. Refused = respondent refused to answer.  
Source: Tsang and Klepeis,1996.





Table 15-64. Number of Minutes Spent Playing on Grass (minutes/day)

Category	Population Group	N	Percentiles											
			1	2	5	10	25	50	75	90	95	98	99	100
Overall		657	0	0	0	0	20	60	120	121	121	121	121	121
Gender	Male	327	0	0	0	0	20	60	121	121	121	121	121	121
Gender	Female	329	0	0	0	0	15	60	120	121	121	121	121	121
Age (years)	1-4	206	0	0	0	0	15	60	120	121	121	121	121	121
Age (years)	5-11	185	0	0	0	0	30	60	121	121	121	121	121	121
Age (years)	12-17	39	0	0	0	0	30	60	120	121	121	121	121	121
Age (years)	18-64	221	0	0	0	0	20	60	120	121	121	121	121	121
Age (years)	> 64	3	30	30	30	30	30	121	121	121	121	121	121	121
Race	White	532	0	0	0	0	20	60	121	121	121	121	121	121
Race	Black	65	0	0	0	3	20	58	90	121	121	121	121	121
Race	Asian	5	10	10	10	10	30	30	30	121	121	121	121	121
Race	Some Others	16	0	0	0	0	10	60	120	121	121	121	121	121
Race	Hispanic	37	0	0	0	0	30	60	110	121	121	121	121	121
Hispanic	No	581	0	0	0	0	20	60	121	121	121	121	121	121
Hispanic	Yes	72	0	0	0	0	10	35	100	121	121	121	121	121
Employment	Full Time	141	0	0	0	0	20	60	121	121	121	121	121	121
Employment	Part Time	27	0	0	0	0	15	60	120	121	121	121	121	121
Employment	Not Employed	55	0	0	0	5	23	60	121	121	121	121	121	121
Education	< High School	20	0	0	0	5	30	60	120.5	121	121	121	121	121
Education	High School Graduate	69	0	0	0	0	15	60	121	121	121	121	121	121
Education	< College	64	0	0	0	0	17.5	46.5	60	121	121	121	121	121
Education	College Graduate	51	0	0	0	1	30	60	121	121	121	121	121	121
Education	Post Graduate	19	0	0	0	0	25	60	121	121	121	121	121	121
Census Region	Northeast	119	0	0	0	0	30	60	121	121	121	121	121	121
Census Region	Midwest	120	0	0	0	7.5	30	60	121	121	121	121	121	121
Census Region	South	252	0	0	0	1	20	60	120	121	121	121	121	121
Census Region	West	166	0	0	0	0	10	45	120	121	121	121	121	121
Day of Week	Weekday	412	0	0	0	0	15	60	120	121	121	121	121	121
Day of Week	Weekend	245	0	0	0	1	30	60	121	121	121	121	121	121
Season	Winter	95	0	0	0	0	4	30	120	121	121	121	121	121
Season	Spring	231	0	0	0	1	30	60	121	121	121	121	121	121
Season	Summer	250	0	0	0	1.5	30	60	121	121	121	121	121	121
Season	Fall	81	0	0	0	0	10	35	120	121	121	121	121	121
Asthma	No	600	0	0	0	0	20	60	120	121	121	121	121	121
Asthma	Yes	56	0	0	0	0	22.5	60	120.5	121	121	121	121	121
Angina	No	656	0	0	0	0	20	60	120	121	121	121	121	121
Bronchitis/Emphysema	No	636	0	0	0	0	20	60	120	121	121	121	121	121
Bronchitis/Emphysema	Yes	21	0	0	0	0	30	60	121	121	121	121	121	121

NOTE: A value of "121" for number of minutes signifies that more than 120 minutes were spent. N = doer sample size. Percentiles are the percentage of doers below or equal to a given number of minutes.  
Source: Tsang and Klepeis, 1996



Table 15-65. Number of Times Swimming in a Month in Freshwater Swimming Pool by the Number of Respondents

	Total N	Times/Month															
		1	2	3	4	5	6	7	8	9	10	11	12	13	14	15	16
<b>Overall</b>	653	147	94	73	47	42	26	11	26	2	38	3	27	2	2	27	2
<b>Gender</b>																	
Male	300	62	47	37	20	16	17	5	9	2	16	2	13	1	*	16	1
Female	352	85	47	36	27	26	9	6	17	*	22	1	14	*	1	11	1
Refused	1	*		*	*	*	*	*	*	*	*	*	*	*	*	*	*
<b>Age (years)</b>																	
*1-4	8	2	2	1	1	1	1	*	*	*	*	*	*	*	*	*	*
1-4	63	11	14	7	3	3	4	1	3	4	4	2	2	1	1	2	2
5-11	100	16	15	7	9	6	4	2	4	1	7	*	5	*	*	11	2
12-17	84	21	13	7	4	8	4	2	3	1	8	*	1	*	*	2	*
18-64	360	86	48	50	27	22	11	5	14	*	18	3	15	1	1	10	*
>64	38	11	2	1	3	2	2	1	2	*	1	3	4	*	*	2	*
<b>Race</b>																	
White	555	126	74	64	44	32	25	10	23	2	36	1	23	2	2	21	1
Black	30	8	7	1	*	*	*	*	1	*	*	*	*	*	*	2	1
Asian	13	3	2	2	*	*	*	*	1	*	1	*	*	*	*	*	*
Some Others	12	2	*	2	1	*	*	*	*	*	*	*	*	*	*	4	*
Hispanic	35	5	8	4	1	6	1	*	1	*	1	*	3	*	*	*	*
Refused	8	3	3	4	*	*	*	*	*	*	*	*	*	*	*	*	*
<b>Hispanic</b>																	
No	591	135	81	68	44	35	25	10	25	2	36	3	24	1	2	24	2
Yes	55	10	11	5	2	6	1	1	1	2	2	*	3	1	1	3	*
DK	2	*	*	*	1	1	*	*	*	*	*	*	*	*	*	*	*
Refused	5	2	2	*	*	*	*	*	*	*	*	*	*	*	*	*	*
<b>Employment</b>																	
*	243	47	41	21	17	15	12	5	10	2	18	*	8	1	1	15	2
Full Time	240	56	38	38	15	13	10	3	8	*	10	1	8	1	1	6	*
Part Time	43	13	2	4	3	8	*	2	1	*	4	2	2	*	*	1	*
Not Employed	122	30	12	10	12	6	3	1	7	*	6	*	9	*	*	5	*
Refused	5	1	1	*	*	*	1	*	*	*	*	*	*	*	*	*	*
<b>Education</b>																	
*	257	51	43	21	18	17	12	5	11	2	19	*	8	1	1	15	2
< High School	16	2	2	3	*	3	1	1	1	*	1	1	*	*	*	*	*
High School Graduate	112	28	15	16	11	6	5	1	1	*	5	1	5	*	1	3	*
<College	104	29	11	11	2	9	2	3	7	*	4	1	7	*	*	3	*
College Graduate	93	22	12	14	10	2	3	2	2	*	5	*	6	*	*	4	*
Post Graduate	71	15	11	8	6	5	3	1	4	*	5	*	1	1	*	2	*
<b>Census Region</b>																	
Northeast	136	32	15	10	16	9	4	1	4	*	13	1	8	1	2	4	*
Midwest	130	35	21	17	8	6	7	2	4	*	9	2	4	1	*	6	*
South	235	46	36	29	13	15	12	7	10	2	10	2	8	*	*	9	2
West	152	34	22	17	10	12	3	1	8	*	6	*	7	*	*	8	*
<b>Day of Week</b>																	
Weekday	445	97	67	52	36	25	15	9	14	1	24	2	18	2	2	21	1
Weekend	208	50	27	21	11	17	11	2	12	1	14	1	9	*	*	6	1
<b>Season</b>																	
Winter	62	19	12	5	3	1	2	*	6	*	2	1	3	*	*	*	*
Spring	174	55	25	19	13	9	7	3	7	*	8	1	7	*	*	2	1
Summer	363	61	45	41	29	26	15	8	12	2	27	2	14	2	2	24	1
Fall	54	12	12	8	2	6	2	*	1	*	1	*	3	*	*	1	*
<b>Asthma</b>																	
No	590	132	81	67	43	38	25	10	24	2	37	3	25	2	2	22	2
Yes	56	14	11	5	4	3	1	1	2	*	1	*	2	*	*	5	*
DK	7	1	2	1	*	1	*	*	*	*	*	*	*	*	*	*	*
<b>Angina</b>																	
No	639	143	90	73	47	41	26	10	26	2	37	3	27	2	2	26	2
Yes	8	3	1	*	*	1	*	1	*	*	1	*	*	*	*	1	*
DK	6	1	3	*	*	*	*	*	*	*	*	*	*	*	*	*	*
<b>Bronchitis/Emphysema</b>																	
No	621	138	91	71	45	40	25	10	24	2	38	2	27	2	2	25	2
Yes	26	8	1	2	1	2	1	1	1	*	*	1	*	*	*	2	*
DK	6	1	2	*	1	*	*	*	1	*	*	*	*	*	*	*	*



	Times/Month																
	18	20	23	24	25	26	28	29	30	31	32	40	42	45	50	60	DK
<b>Overall</b>	2	25	1	1	9	2	1	1	26	2	1	2	2	1	1	2	5
<b>Gender</b>																	
Male	*	10	*	*	4	2	1	*	10	2	1	1	1	*	*	*	4
Female	2	15	1	1	5	*	*	1	16	*	*	1	1	1	1	2	1
Refused	*	*	*	*	*	*	*	*	*	*	*	*	*	*	*	*	*
<b>Age (years)</b>																	
*	*	*	*	*	*	*	*	*	*	*	*	*	*	*	*	*	*
1-4	*	2	*	*	*	*	*	1	2	*	1	*	*	*	*	*	*
5-11	*	3	*	1	2	*	*	*	5	*	*	*	*	*	1	*	*
12-17	1	4	*	*	*	1	*	*	2	*	*	*	*	*	*	1	*
18-64	*	15	1	*	7	1	1	*	15	2	*	2	1	1	*	*	1
> 64	1	1	*	*	*	1	*	2	2	*	*	1	1	*	*	1	3
<b>Race</b>																	
White	2	19	1	1	9	2	1	1	19	2	1	2	2	*	*	2	5
Black	*	3	*	*	*	*	*	*	3	*	*	*	*	*	*	*	*
Asian	*	1	*	*	*	*	*	*	*	*	*	*	*	*	*	*	*
Some Others	*	*	*	*	*	*	*	*	*	*	*	*	*	*	1	*	*
Hispanic	*	1	*	*	*	*	*	*	3	*	*	*	*	1	*	*	*
Refused	*	1	*	*	*	*	*	*	1	*	*	*	*	*	*	*	*
<b>Hispanic</b>																	
No	2	23	1	1	9	2	1	1	20	2	1	2	2	*	1	2	4
Yes	*	1	*	*	*	*	*	*	6	*	*	*	*	1	*	*	1
DK	*	*	*	*	*	*	*	*	*	*	*	*	*	*	*	*	*
Refused	*	1	*	*	*	*	*	*	*	*	*	*	*	*	*	*	*
<b>Employment</b>																	
*	1	9	*	1	2	1	*	1	9	*	1	*	*	*	1	1	1
Full Time	*	8	*	*	5	*	1	*	10	2	*	2	1	1	*	*	2
Part Time	*	*	*	*	1	*	*	*	1	*	*	*	*	*	*	*	*
Not Employed	1	7	1	*	1	1	*	*	6	*	*	*	1	*	*	1	1
Refused	*	1	*	*	*	*	*	*	*	*	*	*	*	*	*	*	1
<b>Education</b>																	
*	1	11	*	1	2	2	*	1	9	*	1	*	*	*	1	1	1
< High School	*	1	*	*	*	*	*	*	1	*	*	*	*	*	*	*	*
High School Graduate	*	6	*	*	1	*	*	*	4	*	*	*	1	*	*	1	1
< College	*	3	1	*	4	*	*	*	4	*	*	*	1	1	*	*	2
College Graduate	*	2	*	*	2	*	*	*	3	2	*	2	1	*	*	*	1
Post Graduate	1	2	*	*	*	*	1	*	5	*	*	*	*	*	*	*	*
<b>Census Region</b>																	
Northeast	*	7	*	*	2	1	*	*	4	1	*	1	1	*	*	*	1
Midwest	*	4	*	*	1	*	*	*	1	*	*	1	1	*	*	*	*
South	2	7	1	1	4	*	1	1	9	1	*	1	*	1	1	1	4
West	*	7	*	*	2	1	*	*	11	*	1	*	*	1	*	1	*
<b>Day of Week</b>																	
Weekday	1	18	1	1	7	1	1	*	19	*	1	1	*	1	1	2	4
Weekend	1	7	*	*	2	1	*	1	7	2	*	1	2	*	*	*	1
<b>Season</b>																	
Winter	1	3	*	*	*	1	1	*	3	1	*	*	1	*	*	*	*
Spring	*	8	*	*	2	*	*	*	3	*	*	*	1	*	*	1	2
Summer	1	10	1	1	7	1	*	1	21	1	1	2	*	1	*	1	3
Fall	*	4	*	*	*	*	*	*	2	*	*	*	*	*	*	*	*
<b>Asthma</b>																	
No	2	21	1	1	9	1	1	1	23	2	1	2	2	1	*	2	5
Yes	*	3	*	*	*	1	*	*	2	*	*	*	*	*	1	*	*
DK	*	1	*	*	*	*	*	*	1	*	*	*	*	*	*	*	*
<b>Angina</b>																	
No	2	24	1	1	9	2	1	1	26	2	1	2	1	1	1	2	5
Yes	*	*	*	*	*	*	*	*	*	*	*	*	1	*	*	*	*
DK	*	1	*	*	*	*	*	*	*	*	*	*	*	*	*	*	*
<b>Bronchitis/Emphysema</b>																	
No	2	22	1	1	9	2	1	1	23	2	1	2	2	1	1	2	4
Yes	*	2	*	*	*	*	*	*	3	*	*	*	*	*	*	*	1
DK	*	1	*	*	*	*	*	*	*	*	*	*	*	*	*	*	*

Note: \* Signifies missing data; "DK" = respondent answered don't know; N= sample size; Refused = respondent refused to answer.  
Source: Tsang And Klepeis, 1996



Table 15-66. Range of the Average Amount of Time Actually Spent in the Water by Swimmers by the Number of Respondents

	Total N	Minutes/Month														
		*-*	0-10	10-20	20-30	30-40	40-50	50-60	60-70	70-80	80-90	90-100	110-120	150-150	180-180	181-181
<b>Overall</b>	653	13	62	75	120	20	39	131	8	2	31	2	68	10	32	40
<b>Gender</b>																
Male	300	5	31	38	60	6	17	55	3	*	18	1	28	6	17	15
Female	352	7	31	37	60	14	22	76	5	2	13	1	40	4	15	25
Refused	1	1	*	*	*	*	*	*	*	*	*	*	*	*	*	*
<b>Age (years)</b>																
*	8	1	2	1	2	*	*	*	*	*	*	*	2	*	*	*
1-4	63	3	5	12	12	1	4	8	*	*	2	*	7	1	3	5
5-11	100	5	3	2	12	5	4	25	*	*	7	*	16	2	11	8
12-17	84	1	3	7	10	2	6	15	*	*	1	*	14	4	6	6
18-64	360	3	45	50	75	8	22	74	8	*	13	1	26	3	12	20
> 64	38	*	4	3	9	4	3	9	*	1	1	*	3	*	*	1
<b>Race</b>																
White	555	7	53	67	105	18	36	109	8	2	24	2	59	9	26	30
Black	30	3	1	1	4	*	*	8	*	*	5	*	1	1	1	5
Asian	13	*	1	1	3	1	*	4	*	*	1	*	1	*	*	1
Some Others	12	*	1	2	1	*	*	3	*	*	*	*	2	*	1	2
Hispanic	35	1	5	4	4	1	2	7	*	*	1	*	4	*	4	2
Refused	8	2	1	*	3	*	1	*	*	*	*	*	1	*	*	*
<b>Hispanic</b>																
No	591	11	57	67	108	19	35	120	8	2	29	2	62	9	28	34
Yes	55	1	5	8	10	1	3	10	*	*	2	*	5	1	4	5
DK	2	*	*	*	*	*	*	1	*	*	*	*	*	*	*	1
Refused	5	1	*	*	2	*	1	*	*	*	*	*	1	*	*	*
<b>Employment</b>																
*	243	9	11	20	34	8	13	48	*	1	16	1	37	7	19	19
Full Time	240	3	31	29	51	4	14	51	3	*	8	*	21	3	10	12
Part Time	43	*	3	10	12	1	3	2	1	*	5	*	2	*	*	4
Not Employed	122	1	16	16	21	7	8	30	4	1	2	1	7	*	3	5
Refused	5	*	1	*	2	*	1	*	*	*	*	*	1	*	*	*
<b>Education</b>																
*	257	9	13	22	35	8	15	50	*	1	17	1	39	7	20	20
< High School	16	*	4	2	3	*	*	3	1	*	1	*	*	*	*	2
High School Graduate	112	1	12	10	16	5	8	26	1	1	5	1	11	*	5	10
< College	104	2	15	16	27	2	4	20	3	*	4	*	6	1	2	2
College Graduate	93	1	8	15	21	2	6	17	1	*	1	*	10	2	4	5
Post Graduate	71	*	10	10	18	3	6	15	2	*	3	*	2	*	1	1
<b>Census Region</b>																
Northeast	136	2	12	17	28	5	9	20	3	1	4	*	13	3	9	10
Midwest	130	3	10	17	27	4	8	24	1	*	6	*	17	1	7	5
South	235	8	20	19	37	6	15	56	*	*	13	1	26	4	12	18
West	152	*	20	22	28	5	7	31	4	1	8	1	12	2	4	7
<b>Day of Week</b>																
Weekday	445	11	45	52	82	14	23	87	7	2	19	*	46	8	22	27
Weekend	208	2	17	23	38	6	16	44	1	*	12	2	22	2	10	13
<b>Season</b>																
Winter	62	2	6	6	10	5	3	14	*	*	3	1	7	1	1	3
Spring	174	3	21	24	37	7	12	32	*	2	6	1	13	3	6	7
Summer	363	7	29	36	64	6	20	77	6	*	20	*	44	6	23	25
Fall	54	1	6	9	9	2	4	8	2	*	2	*	4	*	2	5
<b>Asthma</b>																
No	590	12	52	71	114	19	33	117	8	2	26	2	64	9	26	35
Yes	56	1	9	3	4	*	5	14	*	*	5	*	3	1	6	5
DK	7	*	1	1	2	1	1	*	*	*	*	*	1	*	*	*
<b>Angina</b>																
No	639	13	60	73	118	19	37	130	8	2	30	2	66	10	32	39
Yes	8	*	2	*	1	1	1	1	*	*	1	*	1	*	*	*
DK	6	*	2	*	1	*	1	*	*	*	*	*	1	*	*	1
<b>Bronchitis/emphysema</b>																
No	621	13	56	72	115	19	37	123	7	2	31	2	67	10	30	37
Yes	26	*	5	3	4	1	1	7	*	*	*	*	*	*	2	3
DK	6	*	1	*	1	*	1	1	1	*	*	*	1	*	*	*

Note: \* Signifies missing data. DK = respondents answered don't know. Ref = respondents refused to answer. N = doer sample size in specified range of number of minutes spent. Values of 120, 150, and 180 for number of minutes signify that 2 hours, 2.5 hours, and 3 hours, respectively, were spent.  
Source: Tsang and Klepeis, 1996.



Table 15-67. Number of Minutes Spent Swimming in a Month in Freshwater Swimming Pool (minutes/month)

Category	Population Group	N	Percentiles											
			1	2	5	10	25	50	75	90	95	98	99	100
Overall		640	2	3	10	15	30	60	90	180	181	181	181	181
Gender	Male	295	3	4	8	10	30	45	90	180	181	181	181	181
Gender	Female	345	2	3	10	15	30	60	90	180	181	181	181	181
Age (years)	1-4	60	3	3	7.5	15	20	42.5	120	180	181	181	181	181
Age (years)	5-11	95	2	3	20	30	45	60	120	180	181	181	181	181
Age (years)	12-17	83	4	5	15	20	40	60	120	180	181	181	181	181
Age (years)	18-64	357	2	3	5	10	20	45	60	120	181	181	181	181
Age (years)	> 64	38	5	5	8	10	30	40	60	120	120	181	181	181
Race	White	548	2	3	10	15	30	45	90	180	181	181	181	181
Race	Black	27	10	10	15	30	60	60	150	181	181	181	181	181
Race	Asian	13	4	4	4	20	30	60	60	120	181	181	181	181
Race	Some Others	12	2	2	2	15	25	60	150	181	181	181	181	181
Race	Hispanic	34	3	3	5	10	20	60	120	180	181	181	181	181
Hispanic	No	580	2	3	10	15	30	60	90	180	181	181	181	181
Hispanic	Yes	54	3	5	5	15	30	52.5	120	180	181	181	181	181
Employment	Full Time	237	3	4	5	10	20	45	60	150	181	181	181	181
Employment	Part Time	43	2	2	5	15	20	30	90	120	181	181	181	181
Employment	Not Employed	121	2	2	8	10	20	45	60	120	180	181	181	181
Education	< High School	16	1	1	1	2	12.5	30	60.5	181	181	181	181	181
Education	High School Graduate	111	3	5	8	10	30	60	90	180	181	181	181	181
Education	< College	102	3	3	5	10	20	30	60	120	120	180	181	181
Education	College Graduate	92	2	3	10	15	22.5	42.5	60.5	150	181	181	181	181
Education	Post Graduate	71	5	10	10	10	20	30	60	70	120	180	181	181
Census Region	Northeast	134	4	8	10	15	30	45	120	180	181	181	181	181
Census Region	Midwest	127	5	5	10	15	30	45	90	150	180	181	181	181
Census Region	South	227	2	3	5	15	30	60	120	180	181	181	181	181
Census Region	West	152	2	3	5	10	20	45	61	120	180	181	181	181
Day of Week	Weekday	434	2	3	8	10	30	60	90	180	181	181	181	181
Day of Week	Weekend	206	4	5	10	15	30	60	90	180	181	181	181	181
Season	Winter	60	2	3	5	12.5	30	52.5	90	120	180.5	181	181	181
Season	Spring	171	2	4	5	10	20	40	60	120	180	181	181	181
Season	Summer	356	3	3	10	15	30	60	120	180	181	181	181	181
Season	Fall	53	2	10	10	10	20	45	70	180	181	181	181	181
Asthma	No	578	2	3	10	15	30	55	90	180	181	181	181	181
Asthma	Yes	55	2	3	4	10	30	60	120	180	181	181	181	181
Angina	No	626	2	3	10	15	30	60	90	180	181	181	181	181
Angina	Yes	8	15	15	15	15	25	42.5	75	120	120	120	120	120
Bronchitis/Emphysema	No	608	3	3	10	15	30	60	90	180	181	181	181	181
Bronchitis/Emphysema	Yes	26	2	2	5	5	15	42.5	60	181	181	181	181	181

Note: A Value of 181 for number of minutes signifies that more than 180 minutes were spent. N = doer sample size. Percentiles are the percentage of doers below or equal to a given number of minutes.  
Source: Tsang and Klepeis, 1996.



Table 15-68. Statistics for 24-Hour Cumulative Number of Minutes Spent Working in a Main Job

Category	Population Group	N	Mean	Stdev	Stderr	Min	Max	Percentiles								
								5	25	50	75	90	95	98	99	
All		3259	475.909	179.067	3.1367	1	1440	120	395	500	570	660	740	840	930	
Gender	Male	1733	492.305	186.996	4.4919	1	1440	120	417	510	595	690	770	890	955	
Gender	Female	1526	457.288	167.74	4.294	2	1440	120	390	485	543	620	690	785	850	
Age (years)	*	80	472.375	183.298	20.4933	5	940	117.5	377.5	482.5	560	672.5	850	900	940	
Age (years)	1-4	3	16.667	11.547	6.6667	10	30	10	10	10	30	30	30	30	30	
Age (years)	5-11	10	150.4	185.796	58.754	2	550	2	10	67.5	264	447.5	550	550	550	
Age (years)	12-17	38	293.158	180.681	29.3103	5	840	15	185	269	390	510	675	840	840	
Age (years)	18-64	2993	484.822	173.083	3.1638	1	1440	140	420	505	570	660	745	840	930	
Age (years)	> 64	135	366.148	208.656	17.9582	5	990	30	185	395	500	600	660	840	940	
Race	White	2630	477.536	179.01	3.4906	1	1440	120	400	500	570	660	735	845	933	
Race	Black	343	466.551	175.989	9.5025	5	1037	105	390	490	550	655	735	880	990	
Race	Asian	57	464.053	177.305	23.4846	5	870	45	390	493	553	660	750	780	870	
Race	Some Others	56	477.411	181.661	24.2754	45	855	75	415	510	570	680	765	780	855	
Race	Hispanic	125	465.88	185.322	16.5757	2	840	95	360	485	580	720	750	825	840	
Race	Refused	48	492.083	191.623	27.6584	50	957	120	410	507.5	575	810	840	957	957	
Hispanic	No	2980	475.393	179.214	3.2829	1	1440	120	395	500	570	660	740	850	940	
Hispanic	Yes	221	481.493	174.32	11.726	2	1106	150	405	505	580	670	740	825	840	
Hispanic	DK	12	529.583	146.226	42.2117	295	757	295	425	554	610	710	757	757	757	
Hispanic	Refused	46	468.522	201.347	29.687	10	860	115	350	497.5	585	780	818	860	860	
Employment	*	47	257.915	202.833	29.5863	2	840	5	65	245	390	540	625	840	840	
Employment	Full Time	2679	504.35	164.818	3.1843	1	1440	180	450	510	582	675	750	855	950	
Employment	Part Time	395	364.587	159.361	8.0183	5	945	80	250	365	480	540	600	675	795	
Employment	Not Employed	112	270.946	216.024	20.4123	4	990	9	82.5	245	377.5	600	675	795	870	
Employment	Refused	26	513.577	155.456	30.4875	170	840	225	440	510	570	778	790	840	840	
Education	*	108	343.037	211.879	20.3881	2	860	10	176.5	342.5	510	610	675	840	840	
Education	< High School	217	473.502	216.729	14.7125	4	1440	85	360	485	568	710	795	940	1080	
Education	High School Graduate	1045	482.03	180.638	5.5879	1	1440	120	405	500	565	670	765	890	979	
Education	< College	795	475.585	174.025	6.172	2	1440	140	409	495	563	648	750	825	905	
Education	College Graduate	627	484.526	159.816	6.3824	5	1005	120	424	510	570	645	720	765	815	
Education	Post Graduate	467	483.041	169.574	7.847	1	945	125	400	510	590	660	730	810	860	
Census Region	Northeast	721	475.964	180.84	6.7348	1	1440	120	405	495	570	669	740	890	950	
Census Region	Midwest	755	477.008	182.167	6.6297	2	1440	120	395	495	570	660	750	825	940	
Census Region	South	1142	478.231	176.739	5.23	1	1440	105	405	505	570	660	735	840	900	
Census Region	West	641	470.415	177.801	7.0227	5	1080	120	390	500	570	657	730	850	880	
Day Of Week	Weekday	2788	487.858	166.167	3.147	1	1440	155	425	505	570	660	740	840	930	
Day Of Week	Weekend	471	405.18	229.526	10.576	2	1440	30	245	415	555	670	770	870	960	
Season	Winter	864	475.784	172.828	5.8797	5	1440	150	390	495	570	660	735	835	900	
Season	Spring	791	472.972	195.425	6.9485	1	1440	75	390	495	570	670	765	850	915	
Season	Summer	910	477.185	179.907	5.9639	1	1215	120	400	500	565	670	750	890	979	
Season	Fall	694	477.739	165.961	6.2998	2	1005	130	405	510	570	645	720	780	840	
Asthma	No	3042	477.013	176.967	3.2086	1	1440	120	400	500	570	660	740	840	930	
Asthma	Yes	195	453.354	204.227	14.625	5	1440	45	345	480	550	668	793	855	979	
Asthma	DK	22	523.182	216.952	46.2542	170	1215	225	430	500	565	780	860	1215	1215	
Angina	No	3192	475.735	178.389	3.1574	1	1440	120	395	500	570	660	740	840	930	
Angina	Yes	44	472.068	200.68	30.2536	10	990	60	386	500	572.5	679	730	990	990	
Angina	DK	23	507.391	230.296	48.02	80	1215	170	430	500	565	780	860	1215	1215	
Bronchitis/Emphysema	No	3120	476.547	178.194	3.1902	1	1440	120	400	500	570	660	740	840	930	
Bronchitis/Emphysema	Yes	116	446.991	189.381	17.5836	5	985	30	367.5	480	557.5	644	720	800	855	
Bronchitis/Emphysema	DK	23	535.217	226.256	47.1777	170	1215	225	430	500	600	860	875	1215	1215	

Note: A "\*" Signifies missing data. "DK" = The respondent replied "don't know". Refused = Refused data. N = doer sample size. Mean = Mean 24-hour cumulative number of minutes for doers. Stdev = standard deviation. Stderr = standard error. Min = minimum number of minutes. Max = maximum number of minutes. Percentiles are the percentage of doers below or equal to a given number of minutes.  
 Source: Tsang and Klepeis, 1996.



Table 15-69. Statistics for 24-Hour Cumulative Number of Minutes Spent in Food Preparation

Category	Population Group	N	Mean	Stdev	Stderr	Min	Max	Percentiles									
								5	25	50	75	90	95	98	99		
All		4278	52.35	52.877	0.8084	1	555	5	20	35	65	115	150	210	265		
Gender	Male	1342	37.77	42.133	1.1501	1	480	5	13	30	50	80	105	150	210		
Gender	Female	2936	59.02	55.872	1.0311	1	555	5	25	45	75	120	155	224	272		
Age (years)	*	94	52	43.217	4.4575	5	215	5	20	40	60	110	150	195	215		
Age (years)	1-4	24	56.46	60.37	12.3229	5	240	5	22.5	30	75	150	180	240	240		
Age (years)	5-11	60	25.17	29.688	3.8327	1	120	2	5	11	30	60	107	120	120		
Age (years)	12-17	131	21.7	37.69	3.293	1	385	2	5	10	30	55	70	90	90		
Age (years)	18-64	3173	52.07	52.872	0.9386	1	555	5	20	35	65	110	145	210	265		
Age (years)	> 64	796	60.5	54.669	1.9377	1	525	5	25	45	80	120	150	240	270		
Race	White	3584	51.62	53.259	0.8896	1	555	5	19	35	65	110	145	210	265		
Race	Black	377	57.03	52.289	2.693	1	390	5	20	40	75	120	150	210	240		
Race	Asian	62	54	41.822	5.3115	2	210	5	20	50	70	105	130	175	210		
Race	Some Others	66	50.59	53.237	6.553	1	295	5	15	33.5	70	115	150	210	295		
Race	Hispanic	132	58.76	49.73	4.3285	2	315	5	23.5	52.5	79.5	110	135	225	285		
Race	Refused	57	53.14	49.297	6.5295	2	210	5	20	40	60	120	180	195	210		
Hispanic	No	3960	51.84	52.603	0.8359	1	555	5	20	35	65	111	145	205	255		
Hispanic	Yes	254	58.99	56.694	3.5573	2	420	5	20	45	75	120	155	240	315		
Hispanic	DK	20	54.95	53.2	11.8959	6	240	8	25	45	60	112.5	180	240	240		
Hispanic	Refused	44	58.61	53.296	8.0346	2	210	5	27.5	37.5	80	150	180	210	210		
Employment	*	210	27.17	40.549	2.7981	1	385	2	5	15	30	60	90	120	180		
Employment	Full Time	1988	45.46	46.66	1.0465	1	480	5	15	30	60	90	130	180	240		
Employment	Part Time	419	53.85	55.413	2.7071	2	520	5	20	40	65	105	125	205	255		
Employment	Not Employed	1626	63.62	57.743	1.432	1	555	5	29	45	90	125	170	240	275		
Employment	Refused	35	53.54	66.78	11.2879	2	340	2	20	30	60	120	195	340	340		
Education	*	291	31.71	42.621	2.4985	1	385	2	5	15	37	75	120	155	195		
Education	< High School	450	61.26	53.232	2.5094	1	555	5	30	45	90	120	150	197	225		
Education	High School Graduate	1449	58.84	56.665	1.4886	1	520	5	22	45	75	120	155	240	310		
Education	< College	954	51.99	52.238	1.6913	1	525	5	20	34.5	65	110	150	210	245		
Education	College Graduate	659	46.2	48.078	1.8728	1	515	5	15	30	60	100	125	180	224		
Education	Post Graduate	475	46.04	48.686	2.2339	1	375	5	15	30	60	95	135	200	270		
Census Region	Northeast	953	52.3	53.178	1.7226	1	480	5	20	40	60	110	140	205	255		
Census Region	Midwest	956	53.23	51.814	1.6758	1	520	5	20	35	65	120	150	210	265		
Census Region	South	1452	53.35	53.471	1.4032	1	555	5	15.5	35	70	120	150	195	245		
Census Region	West	917	49.91	52.72	1.741	1	515	5	15	31	60	105	135	225	265		
Day Of Week	Weekday	2995	50.05	49.979	0.9132	1	555	5	19	35	60	105	132	180	240		
Day Of Week	Weekend	1283	57.72	58.762	1.6405	1	420	5	20	40	75	130	180	240	300		
Season	Winter	1174	50.62	48.626	1.4192	1	480	5	18	35	65	110	135	195	240		
Season	Spring	1038	54.39	54.484	1.6911	1	525	5	20	38.5	70	120	150	224	265		
Season	Summer	1147	51.34	54.194	1.6002	1	555	5	20	35	60	110	137	208	300		
Season	Fall	919	53.54	54.535	1.7989	1	520	5	20	37	67	120	155	200	265		
Asthma	No	3948	52.02	53.176	0.8463	1	555	5	20	35	65	110	145	210	265		
Asthma	Yes	300	57.14	49.443	2.8546	1	272	5	20.5	45	75	120	160	199	240		
Asthma	DK	30	47.63	44.812	8.1815	2	195	5	10	32.5	60	117.5	120	195	195		
Angina	No	4091	52.18	52.97	0.8282	1	555	5	20	35	65	115	150	210	265		
Angina	Yes	149	56.81	48.238	3.9518	1	340	5	25	45	80	120	135	180	210		
Angina	DK	38	53.97	60.417	9.8009	2	240	2	10	32.5	60	120	240	240	240		
Bronchitis/Emphysema	No	4024	52.01	53.092	0.837	1	555	5	20	35	65	110	145	210	265		
Bronchitis/Emphysema	Yes	216	56.91	46.683	3.1764	3	240	5	20	45	85	120	150	198	210		
Bronchitis/Emphysema	DK	38	62.39	61.703	10.0096	2	240	2	20	42.5	90	150	240	240	240		

Note: A "\*" Signifies missing data. "DK" = The respondent replied "don't know". Refused = Refused data. N = doer sample size. Mean = Mean 24-hour cumulative number of minutes for doers. Stdev = standard deviation. Stderr = standard error. Min = minimum number of minutes. Max = maximum number of minutes. Percentiles are the percentage of doers below or equal to a given number of minutes.  
Source: Tsang and Klepac, 1996.



Table 15-70. Statistics for 24-Hour Cumulative Number of Minutes Spent in Food Cleanup

Group Name	Group Code	N	Mean	Stdev	Stderr	Min	Max	Percentiles								
								5	25	50	75	90	95	98	99	
All		1143	32.9948	40.379	1.1944	1	825	8	15	30	35	60	85	120	135	
Gender	Male	204	27.4951	20.398	1.4282	1	180	10	15	25	30	50	60	80	85	
Gender	Female	939	34.1896	43.44	1.4176	1	825	5	15	30	35	60	90	120	150	
Age (years)	*	24	31.0417	28.013	5.7182	10	120	10	15	30	30	60	105	120	120	
Age (years)	1-4	5	41.6	48.04	21.4839	3	120	3	15	15	55	120	120	120	120	
Age (years)	5-11	9	28.4444	21.634	7.2113	1	75	1	15	30	30	75	75	75	75	
Age (years)	12-17	28	26.75	20.573	3.8879	2	90	5	12.5	20	30	60	65	90	90	
Age (years)	18-64	808	31.3317	27.053	0.9517	1	330	10	15	30	30	60	80	120	120	
Age (years)	> 64	269	38.8067	67.357	4.1068	1	825	5	15	30	40	60	105	130	270	
Race	White	976	32.9652	41.685	1.3343	1	825	8	15	30	35	60	84	120	130	
Race	Black	82	33.2805	28.602	3.1585	5	180	10	15	30	30	65	90	120	180	
Race	Asian	11	27.0909	22.047	6.6476	3	75	3	15	15	30	60	75	75	75	
Race	Some Others	17	29.7059	34.797	8.4396	5	150	5	10	15	30	60	150	150	150	
Race	Hispanic	42	35.6429	39.899	6.1565	3	255	10	15	30	40	50	60	255	255	
Race	Refused	15	34	28.234	7.2899	5	90	5	10	30	60	90	90	90	90	
Hispanic	No	1057	32.7351	40.353	1.2412	1	825	5	15	30	35	60	85	120	130	
Hispanic	Yes	68	38.9265	44.877	5.4422	3	270	10	15	30	40	60	120	255	270	
Hispanic	DK	6	24.1667	9.704	3.9616	10	35	10	15	27.5	30	35	35	35	35	
Hispanic	Refused	12	26.6667	18.257	5.2705	5	60	5	12.5	25	32.5	60	60	60	60	
Employment	*	39	28.1538	25.77	4.1265	1	120	2	15	15	30	65	90	120	120	
Employment	Full Time	432	28.4236	22.686	1.0915	2	255	8	15	25	30	50	60	90	120	
Employment	Part Time	134	28.903	21.322	1.842	3	150	10	15	25	30	60	60	95	100	
Employment	Not Employed	528	38.2254	53.763	2.3398	1	825	5	15	30	45	60	105	120	250	
Employment	Refused	10	28	21.884	6.9202	10	60	10	10	17.5	55	60	60	60	60	
Education	*	59	27.2542	22.695	2.9546	1	120	3	10	20	30	60	75	90	120	
Education	< High School	135	41.8593	58.603	5.0437	2	570	5	15	30	45	85	120	180	270	
Education	High School Graduate	445	33.3483	45.827	2.1724	1	825	10	15	30	30	60	90	120	120	
Education	< College	259	33.5907	30.026	1.8657	5	255	10	15	30	45	60	85	105	150	
Education	College Graduate	142	27.7254	21.846	1.8333	1	180	10	15	22.5	30	50	60	90	120	
Education	Post Graduate	103	28.9029	34.476	3.397	3	330	5	15	25	30	50	60	60	120	
Census Region	Northeast	295	32.6169	28.347	1.6504	3	270	5	15	30	40	60	90	120	120	
Census Region	Midwest	252	28.4643	22.677	1.4285	1	210	5	15	30	30	50	60	85	120	
Census Region	South	343	35.9242	52.496	2.8345	1	825	10	15	30	40	65	90	120	180	
Census Region	West	253	33.9763	46.539	2.9259	3	570	10	15	27	30	60	75	120	255	
Day Of Week	Weekday	782	32.1957	43.579	1.5584	1	825	8	15	30	30	60	75	120	120	
Day Of Week	Weekend	361	34.7258	32.371	1.7037	5	270	8	15	30	40	60	90	120	180	
Season	Winter	303	33.1188	51.809	2.9763	1	825	8	15	30	30	60	85	120	120	
Season	Spring	245	30.2939	26.108	1.668	2	250	10	15	30	30	60	65	105	120	
Season	Summer	293	33.157	29.932	1.7487	2	270	5	15	30	40	60	90	120	135	
Season	Fall	302	34.904	45.406	2.6128	1	570	8	15	30	40	60	90	120	180	
Asthma	No	1047	32.7708	40.408	1.2488	1	825	6	15	30	35	60	85	120	120	
Asthma	Yes	91	35.956	40.996	4.2975	2	255	8	15	30	40	60	90	250	255	
Asthma	DK	5	26	20.736	9.2736	10	60	10	10	20	30	60	60	60	60	
Angina	No	1092	32.9661	40.95	1.2392	1	825	8	15	30	35	60	85	120	150	
Angina	Yes	45	32.3111	22.926	3.4175	5	120	5	15	30	45	60	60	120	120	
Angina	DK	6	43.3333	41.793	17.062	10	120	10	10	30	60	120	120	120	120	
Bronchitis/Emphysema	No	1065	31.77	28.195	0.864	1	330	8	15	30	35	60	80	120	120	
Bronchitis/Emphysema	Yes	71	50.8592	118.417	14.0535	3	825	5	15	29	35	70	105	570	825	
Bronchitis/Emphysema	DK	7	38.1429	41.119	15.5417	2	120	2	10	30	60	120	120	120	120	

Note: A "\*" Signifies missing data. "DK" = The respondent replied "don't know". Refused = Refused data. N = doer sample size. Mean = Mean 24-hour cumulative number of minutes for doers. Stdev = standard deviation. Stderr = standard error. Min = minimum number of minutes. Max = maximum number of minutes. Percentiles are the percentage of doers below or equal to a given number of minutes. Source: Tsang and Klepeis, 1996.





Table 15-71. Statistics for 24-Hour Cumulative Number of Minutes Spent Cleaning House

Category	Population Group	N	Mean	Stdev	Stderr	Min	Max	Percentiles							
								5	25	50	75	90	95	98	99
All		1910	114.798	111.683	2.5555	1	810	10	30	80	150	255	335	465	525
Gender	Male	351	100.353	110.445	5.8951	1	810	10	30	60	120	240	310	400	495
Gender	Female	1559	118.051	111.737	2.8299	1	790	15	40	90	160	255	340	465	540
Age (years)	*	45	136.2	114.124	17.0127	10	480	10	55	105	180	297	320	480	480
Age (years)	1-4	11	74.091	69.42	20.9308	10	270	10	40	60	90	90	270	270	270
Age (years)	5-11	49	42.633	35.19	5.0271	1	180	5	20	30	53	90	120	180	180
Age (years)	12-17	67	78.746	79.357	9.695	1	300	5	20	55	105	240	240	285	300
Age (years)	18-64	1307	115.55	111.597	3.0868	1	810	15	30	85	150	270	350	435	510
Age (years)	> 64	431	125.132	118.341	5.7003	3	790	10	45	90	170	250	340	540	570
Race	White	1614	115.85	111.348	2.7716	1	790	10	35	85	155	255	330	435	540
Race	Black	139	108.712	106.826	9.0609	1	490	5	30	80	135	270	358	480	484
Race	Asian	32	97.656	101.091	17.8705	15	425	15	30	60	127.5	265	345	425	425
Race	Some Others	26	80.5	58.059	11.3864	5	210	10	35	60	115	185	190	210	210
Race	Hispanic	73	99.781	110.669	12.9528	5	548	10	30	60	120	210	345	470	548
Race	Refused	26	179.615	176.878	34.6886	10	810	20	30	135	240	390	465	810	810
Hispanic	No	1740	114.153	109.99	2.6368	1	790	10	30	80	150	255	330	435	525
Hispanic	Yes	134	110.134	115.754	9.9996	5	658	10	34	60	135	240	360	480	548
Hispanic	DK	14	136.071	131.591	35.1691	10	510	10	30	92.5	210	240	510	510	510
Hispanic	Refused	22	180.682	177.33	37.8069	10	810	20	45	138	240	340	390	810	810
Employment	*	128	64.453	66.811	5.9053	1	300	5	22.5	45	77.5	180	240	270	285
Employment	Full Time	673	100.944	99.87	3.8497	1	655	10	30	60	120	240	310	410	480
Employment	Part Time	195	119.415	115.568	8.276	1	660	15	45	85	175	265	390	480	540
Employment	Not Employed	901	129.566	118.009	3.9314	3	790	15	50	95	180	285	360	480	570
Employment	Refused	13	235	218.908	60.7142	10	810	10	120	180	255	450	810	810	810
Education	*	161	81.379	98.129	7.7337	1	810	5	28	45	100	225	265	300	375
Education	< High School	234	135.731	121.618	7.9504	3	715	10	50	115	180	297	390	540	560
Education	High School Graduate	665	121.899	118.814	4.6074	2	790	15	40	90	160	270	360	484	610
Education	< College	432	108.343	100.456	4.8332	1	570	10	30	85	149	240	315	420	470
Education	College Graduate	247	101.097	96.605	6.1468	1	525	15	30	60	127	240	315	390	465
Education	Post Graduate	171	126.105	118.897	9.0923	5	655	15	45	90	180	280	390	495	540
Census Region	Northeast	454	116.969	117.268	5.5037	2	790	10	30	90	164	240	330	480	655
Census Region	Midwest	406	114.086	111.049	5.5113	1	720	10	30	80	150	240	325	475	495
Census Region	South	636	114.36	112.921	4.4776	1	810	10	30	80	150	270	360	435	525
Census Region	West	414	113.79	104.234	5.1228	5	720	15	40	82.5	160	240	330	400	470
Day Of Week	Weekday	1287	108.319	108.542	3.0256	1	790	10	30	70	150	240	315	465	540
Day Of Week	Weekend	623	128.185	116.861	4.682	1	810	15	45	90	180	290	370	435	525
Season	Winter	464	105.554	98.348	4.5657	1	810	10	30	75	150	240	285	360	465
Season	Spring	445	114.202	109.757	5.203	3	720	15	30	75	165	240	340	465	525
Season	Summer	546	109.908	113.686	4.8653	1	690	10	30	71	135	245	365	465	548
Season	Fall	455	130.677	122.137	5.7259	1	790	15	45	90	180	300	390	480	560
Asthma	No	1764	114.32	110.119	2.6219	1	790	10	30	82.5	150	255	330	450	525
Asthma	Yes	133	114.699	117.523	10.1905	5	690	10	33	64	150	270	390	470	480
Asthma	DK	13	180.769	214.533	59.5007	10	810	10	45	120	240	340	810	810	810
Angina	No	1826	113.702	110.563	2.5874	1	790	14	30	80	150	255	330	465	525
Angina	Yes	70	120.371	103.11	12.324	5	394	5	30	90	190	262.5	320	370	394
Angina	DK	14	230	210.868	56.3569	10	810	10	120	210	255	480	810	810	810
Bronchitis/Emphysema	No	1791	113.894	111.025	2.6234	1	790	10	30	80	150	255	340	450	540
Bronchitis/Emphysema	Yes	100	118.11	104.363	10.4363	5	480	7.5	32.5	90	180	262.5	297.5	467.5	475
Bronchitis/Emphysema	DK	19	182.632	179.253	41.1234	5	810	5	50	150	240	340	810	810	810

Note: A "\*" Signifies missing data. "DK" = The respondent replied "don't know". Refused = Refused data. N = doer sample size. Mean = Mean 24-hour cumulative number of minutes for doers. Stdev = standard deviation. Stderr = standard error. Min = minimum number of minutes. Max = maximum number of minutes. Percentiles are the percentage of doers below or equal to a given number of minutes. Source: Tsang and Klepeis, 1996.



Table 15-72. Statistics for 24-Hour Cumulative Number of Minutes Spent in Outdoor Cleaning

Category	Population Group	N	Mean	Stdev	Stderr	Min	Max	Percentiles							
								5	25	50	75	90	95	98	99
All		692	145.9	121.42	4.616	2	720	25	60	120	180	300	405	510	570
Gender	Male	417	160.8	131.68	6.448	10	720	30	60	120	200	345	480	533	600
Gender	Female	275	123.2	99.98	6.029	2	635	10	60	90	160	268	330	390	465
Age (years)	*	13	210.5	157.91	43.796	30	600	30	112	140	250	395	600	600	600
Age (years)	1-4	4	138.3	116.84	58.421	30	285	30	45	119	231.5	285	285	285	285
Age (years)	5-11	12	104.6	62.921	18.164	30	210	30	58	80	165	190	210	210	210
Age (years)	12-17	20	142.3	96.274	21.527	30	385	32.5	75	127	157.5	300	372.5	385	385
Age (years)	18-64	479	147.4	125.22	5.721	2	690	15	60	120	180	310	435	520	570
Age (years)	> 64	164	139.9	112.13	8.756	2	720	30	60	120	172.5	300	350	480	510
Race	White	621	146.4	122.18	4.903	2	720	25	60	120	180	305	410	510	560
Race	Black	30	134.2	99.049	18.084	2	405	10	60	117.5	190	262.5	330	405	405
Race	Asian	6	65	27.568	11.255	30	90	30	30	77.5	85	90	90	90	90
Race	Some Others	12	163.5	97.091	28.028	39	380	39	90	157.5	187.5	290	380	380	380
Race	Hispanic	14	128.2	82.593	22.074	30	300	30	65	105	180	255	300	300	300
Race	Refused	9	206.7	213.95	71.317	30	600	30	60	120	300	600	600	600	600
Hispanic	No	652	145.6	121.19	4.746	2	720	25	60	120	180	300	405	510	560
Hispanic	Yes	26	115.3	76.402	14.984	10	300	25	60	116.5	145	240	255	300	300
Hispanic	DK	5	218	103.05	46.087	120	380	120	140	210	240	380	380	380	380
Hispanic	Refused	9	216.7	206.64	68.88	60	600	60	60	120	300	600	600	600	600
Employment	*	38	132.1	88.152	14.3	30	385	30	60	115	165	255	360	385	385
Employment	Full Time	315	147.7	123.2	6.942	4	690	30	60	120	180	300	435	530	560
Employment	Part Time	52	135.1	103.74	14.387	2	470	15	60	112.5	180	300	325	325	470
Employment	Not Employed	280	145.1	122.82	7.34	2	720	20	60	120	180	310	412.5	480	655
Employment	Refused	7	252.9	216.41	81.794	15	600	15	120	120	465	600	600	600	600
Education	*	46	136.8	115.99	17.101	2	600	30	60	112.5	165	285	360	600	600
Education	< High School	96	146	124.59	12.716	2	510	10	60	119.5	180	330	465	480	510
Education	High School Graduate	237	154.2	126.38	8.209	5	720	30	60	120	180	310	415	520	660
Education	< College	142	146.7	119.87	10.059	4	655	30	60	120	185	270	375	560	570
Education	College Graduate	99	137.3	124.43	12.505	10	555	15	60	95	175	325	475	533	555
Education	Post Graduate	72	134.3	103.25	12.168	10	495	30	60	120	165	290	345	465	495
Census Region	Northeast	144	135.2	113.42	9.451	5	600	15	60	110	185	300	330	510	555
Census Region	Midwest	155	131	111.34	8.943	4	655	15	60	95	150	270	360	510	560
Census Region	South	218	158.7	117.58	7.964	2	635	30	70	120	195	330	415	510	520
Census Region	West	175	151.8	138.65	10.481	2	720	25	60	120	180	355	475	530	690
Day Of Week	Weekday	420	132.5	109.32	5.334	4	660	20	60	105	175	285	360	475	530
Day Of Week	Weekend	272	166.6	135.66	8.225	2	720	30	60	120	227.5	345	495	533	635
Season	Winter	128	149.5	135.12	11.943	4	600	15	59.5	102.5	225	345	465	510	520
Season	Spring	252	151.3	116.12	7.315	5	690	30	70	120	180	300	410	510	530
Season	Summer	205	133	104.23	7.28	5	635	20	60	120	180	270	325	475	555
Season	Fall	107	153.4	144.65	13.984	2	720	15	60	120	180	360	480	655	660
Asthma	No	640	147.3	121.44	4.8	2	720	27.5	60	120	180	307.5	400	510	560
Asthma	Yes	47	109.1	87.096	12.704	5	510	15	60	90	135	210	240	510	510
Asthma	DK	5	312	230.04	102.879	60	600	60	120	300	480	600	600	600	600
Angina	No	665	143.6	118.92	4.611	2	720	25	60	120	180	300	385	510	560
Angina	Yes	18	144.7	96.703	22.793	30	330	30	60	135	165	330	330	330	330
Angina	DK	9	318.9	213.67	71.223	10	600	10	120	325	480	600	600	600	600
Bronchitis/emphysema	No	661	146.2	120.68	4.694	2	720	30	60	120	180	300	395	510	560
Bronchitis/emphysema	Yes	26	104.8	85.282	16.725	5	375	10	60	90	135	225	300	375	375
Bronchitis/emphysema	DK	5	312	230.04	102.879	60	600	60	120	300	480	600	600	600	600

Note: A "\*" Signifies missing data. "DK" = The respondent replied "don't know". Refused = Refused data. N = doer sample size. Mean = Mean 24-hour cumulative number of minutes for doers. Stdev = standard deviation. Stderr = standard error. Min = minimum number of minutes. Max = maximum number of minutes. Percentiles are the percentage of doers below or equal to a given number of minutes.  
Source: Tsang and Klepeis, 1996.



Table 15-73. Statistics for 24-Hour Cumulative Number of Minutes Spent in Clothes Care

Category	Population Group	N	Mean	Stdev	Stderr	Min	Max	Percentiles							
								5	25	50	75	90	95	98	99
All		893	79.479	73.355	2.455	2	535	10	30	60	118	175	210	300	375
Gender	Male	117	72.248	67.028	6.197	5	360	7	20	60	90	150	210	300	335
Gender	Female	776	80.57	74.241	2.665	2	535	10	30	60	120	180	225	300	375
Age (years)	*	10	59.5	34.757	10.991	15	120	15	25	60	90	105	120	120	120
Age (years)	1-4	4	70	94.251	47.126	5	210	5	17.5	32.5	122.5	210	210	210	210
Age (years)	5-11	11	39	33.856	10.208	2	92	2	5	30	60	90	92	92	92
Age (years)	12-17	21	37.476	39.447	8.608	3	150	5	10	20	60	80	120	150	150
Age (years)	18-64	702	80.474	74.354	2.806	2	535	10	28	60	120	180	210	300	360
Age (years)	> 64	145	85.455	73.545	6.108	2	375	10	30	60	120	180	245	300	375
Race	White	737	80.096	73.392	2.703	2	535	10	30	60	118	175	223	300	375
Race	Black	99	68.636	65.289	6.562	5	300	5	15	45	110	165	210	240	300
Race	Asian	7	107.857	48.807	18.447	60	210	60	80	90	120	210	210	210	210
Race	Some Others	10	62.4	39.09	12.361	18	120	18	21	65	90	120	120	120	120
Race	Hispanic	33	92.879	78.01	13.58	5	265	5	20	90	150	210	225	265	265
Race	Refused	7	100.714	166.018	62.749	15	475	15	20	45	60	475	475	475	475
Hispanic	No	836	78.248	72.306	2.501	2	535	10	30	60	115	165	210	300	360
Hispanic	Yes	51	91.176	71.178	9.967	5	265	5	20	90	150	190	225	225	265
Hispanic	DK	3	118.333	62.517	36.094	55	180	55	55	120	180	180	180	180	180
Hispanic	Refused	3	185	251.942	145.459	20	475	20	20	60	475	475	475	475	475
Employment	*	34	43.412	46.313	7.943	2	210	3	10	30	60	92	150	210	210
Employment	Full Time	402	73.443	73.706	3.676	2	535	5	20	60	100	155	223	300	360
Employment	Part Time	116	80.724	68.545	6.364	2	335	10	30	67.5	117.5	180	225	240	330
Employment	Not Employed	336	89.804	75.166	4.101	2	475	10	35	60	120	185	235	300	375
Employment	Refused	5	87.4	74.725	33.418	2	180	2	45	60	150	180	180	180	180
Education	*	43	47.488	48.217	7.353	2	210	5	10	30	60	92	150	210	210
Education	< High School	102	86.51	60.048	5.946	10	265	15	38	65	120	175	210	240	245
Education	High School Graduate	337	85.19	82.249	4.48	2	535	10	30	60	120	180	240	375	445
Education	< College	193	85.87	78.466	5.648	2	475	5	21	60	120	190	240	300	375
Education	College Graduate	127	67.756	56.995	5.058	5	260	10	20	60	90	150	190	225	225
Education	Post Graduate	91	68.374	64.714	6.784	5	360	5	20	60	90	145	210	245	360
Census Region	Northeast	222	76.905	67.875	4.555	2	535	10	30	60	120	150	200	245	300
Census Region	Midwest	201	78.448	75.998	5.36	2	475	5	20	60	115	170	210	265	420
Census Region	South	304	81.839	75.654	4.339	5	450	10	30	60	115	170	235	330	375
Census Region	West	166	79.849	73.398	5.697	2	405	5	20	60	120	180	223	300	360
Day Of Week	Weekday	607	75.853	72.909	2.959	2	475	5	25	60	105	160	210	300	375
Day Of Week	Weekend	286	87.175	73.832	4.366	5	535	10	30	65	120	180	223	300	335
Season	Winter	254	82.291	80.245	5.035	2	475	7	23	60	120	190	225	330	445
Season	Spring	213	86.103	79.325	5.435	2	450	10	30	60	120	180	240	335	375
Season	Summer	259	76.722	68.328	4.246	2	535	8	30	60	115	154	190	240	360
Season	Fall	167	71.03	60.463	4.679	3	300	5	25	60	105	150	195	240	300
Asthma	No	829	79.534	74.024	2.571	2	535	10	30	60	118	180	225	300	360
Asthma	Yes	62	79.855	65.269	8.289	5	375	10	30	66.5	120	154	180	200	375
Asthma	DK	2	45	21.213	15	30	60	30	30	45	60	60	60	60	60
Angina	No	867	79.516	73.48	2.496	2	535	10	30	60	120	178	210	300	375
Angina	Yes	22	81.591	75.756	16.151	5	335	10	30	60	120	155	195	335	335
Angina	DK	4	60	24.495	12.247	30	90	30	45	60	75	90	90	90	90
Bronchitis/emphysema	No	834	78.45	73.617	2.549	2	535	8	25	60	115	170	210	300	375
Bronchitis/emphysema	Yes	58	94.621	68.927	9.051	5	335	15	60	77.5	120	190	240	300	335
Bronchitis/emphysema	DK	1	60	0	0	60	60	60	60	60	60	60	60	60	60

Note: A "\*" Signifies missing data. "DK" = The respondent replied "don't know". Refused = Refused data. N = doer sample size. Mean = Mean 24-hour cumulative number of minutes for doers. Stdev = standard deviation. Stderr = standard error. Min = minimum number of minutes. Max = maximum number of minutes. Percentiles are the percentage of doers below or equal to a given number of minutes. Source: Tsang and Klepeis, 1996.



Table 15-74. Statistics for 24-Hour Cumulative Number of Minutes Spent in Car Repair/Maintenance

Category	Population Group	N	Mean	Stdev	Stderr	Min	Max	Percentiles							
								5	25	50	75	90	95	98	99
All		145	123.407	147.198	12.224	5	700	5	30	60	150	300	495	670	690
Gender	Male	110	135.582	152.737	14.563	5	700	5	30	85	170	300	505	600	670
Gender	Female	35	85.143	122.441	20.696	5	690	5	15	45	120	180	270	690	690
Age (years)	*	1	60	*	*	60	60	60	60	60	60	60	60	60	60
Age (years)	1-4	1	150	*	*	150	150	150	150	150	150	150	150	150	150
Age (years)	5-11	1	300	*	*	300	300	300	300	300	300	300	300	300	300
Age (years)	12-17	8	106.875	163.837	57.925	20	505	20	30	45	90	505	505	505	505
Age (years)	18-64	114	130.342	156.511	14.659	5	700	5	30	77.5	165	300	520	670	690
Age (years)	> 64	20	83.5	68.347	15.283	10	300	12.5	30	70	120	150	240	300	300
Race	White	112	139.607	158.66	14.992	5	700	10	30	90	175	300	520	670	690
Race	Black	19	85.789	93.516	21.454	5	300	5	20	60	95	300	300	300	300
Race	Asian	2	10	7.071	5	5	15	5	5	10	15	15	15	15	15
Race	Some Others	6	43.333	42.387	17.304	5	120	5	10	32.5	60	120	120	120	120
Race	Hispanic	6	58	51.595	21.063	5	120	5	13	45	120	120	120	120	120
Hispanic	No	133	123.617	144.993	12.573	5	700	5	30	80	150	300	495	670	690
Hispanic	Yes	10	98.8	153.362	48.497	5	520	5	30	45	120	320	520	520	520
Hispanic	DK	2	232.5	321.734	227.5	5	460	5	5	233	460	460	460	460	460
Employment	*	10	130.5	156.87	49.607	20	505	20	30	52.5	150	402.5	505	505	505
Employment	Full Time	77	122.091	150.192	17.116	5	700	5	30	60	165	300	520	670	700
Employment	Part Time	12	123.167	138.769	40.059	8	495	8	40	72.5	150	270	495	495	495
Employment	Not Employed	46	124.13	146.952	21.667	5	690	10	30	90	120	300	480	690	690
Education	*	13	120	139.523	38.697	15	505	15	30	60	120	300	505	505	505
Education	< High School	17	185.882	224.418	54.429	5	670	5	30	90	220	555	670	670	670
Education	High School Graduate	50	111.52	128.261	18.139	5	690	5	30	67.5	120	270	350	585	690
Education	< College	31	138.226	169.231	30.395	5	700	10	30	85	180	280	600	700	700
Education	College Graduate	20	93.25	99.344	22.214	10	300	10	15	45	135	285	300	300	300
Education	Post Graduate	14	103.429	97.566	26.076	5	300	5	30	75	120	300	300	300	300
Census Region	Northeast	28	130.75	163.729	30.942	8	690	10	30	60	200	300	520	690	690
Census Region	Midwest	31	149.839	173.193	31.106	10	670	10	45	90	120	350	600	670	670
Census Region	South	45	106.778	131.409	19.589	5	700	5	30	60	120	240	300	700	700
Census Region	West	41	116.659	132.206	20.647	5	505	5	30	60	120	300	460	505	505
Day Of Week	Weekday	79	108.519	125.914	14.166	5	690	5	15	60	150	280	350	480	690
Day Of Week	Weekend	66	141.227	168.477	20.738	5	700	10	45	82.5	150	495	555	670	700
Season	Winter	49	130.673	167.715	23.959	5	690	5	30	60	165	350	600	690	690
Season	Spring	39	136.667	156.042	24.987	5	700	5	45	85	150	300	555	700	700
Season	Summer	35	121.514	137.704	23.276	5	505	5	30	60	150	300	480	505	505
Season	Fall	22	86.727	87.502	18.655	5	300	8	10	70	120	240	270	300	300
Asthma	No	137	117.657	139.579	11.925	5	700	5	30	60	120	300	495	600	690
Asthma	Yes	8	221.875	235.553	83.281	15	670	15	30	150	365	670	670	670	670
Angina	No	139	125.712	149.156	12.651	5	700	5	30	75	150	300	505	670	690
Angina	Yes	5	51	72.921	32.611	5	180	5	15	20	35	180	180	180	180
Angina	DK	1	165	*	*	165	165	165	165	165	165	165	165	165	165
Bronchitis/Emphysema	No	140	122.279	145.67	12.311	5	700	5	30	67.5	135	300	500	670	690
Bronchitis/Emphysema	Yes	5	155	203.347	90.94	5	460	5	10	30	270	460	460	460	460

Note: A "\*" Signifies missing data. "DK" = The respondent replied "don't know". N = doer sample size. Mean = Mean 24-hour cumulative number of minutes for doers. Stdev = standard deviation. Stderr = standard error. Min = minimum number of minutes. Max = maximum number of minutes. Percentiles are the percentage of doers below or equal to a given number of minutes.  
Source: Tsang and Klepejs, 1996.



Table 15-75. Statistics for 24-Hour Cumulative Number of Minutes Spent in Other Repairs

Group Name	Group Code	N	Mean	Stdev	Stderr	Min	Max	Percentiles									
								5	25	50	75	90	95	98	99		
All		288	184.816	184.111	10.849	2	1080	10	36.5	120	300	425	525	690	840		
Gender	Male	200	205.045	187.704	13.273	2	1080	10	60	150	327.5	460	555	680	810		
Gender	Female	88	138.841	167.784	17.886	3	900	5	17.5	72.5	192.5	360	425	750	900		
Age (years)	*	1	540	*	*	540	540	540	540	540	540	540	540	540	540		
Age (years)	5-11	3	66.667	55.076	31.798	10	120	10	10	70	120	120	120	120	120		
Age (years)	12-17	14	119.5	103.383	27.63	15	345	15	30	90	180	285	345	345	345		
Age (years)	18-64	221	198.471	192.928	12.978	2	1080	10	45	120	325	434	570	750	840		
Age (years)	> 64	49	141.878	146.868	20.981	2	526	10	30	75	209	390	480	526	526		
Race	White	264	186.367	184.944	11.382	2	1080	10	36.5	120	300	430	525	670	840		
Race	Black	13	150.385	207.961	57.678	10	750	10	30	90	120	390	750	750	750		
Race	Asian	3	321.667	89.489	51.667	270	425	270	270	270	425	425	425	425	425		
Race	Some Others	3	173.667	165.228	95.395	45	360	45	45	116	360	360	360	360	360		
Race	Hispanic	4	127.5	122.848	61.424	10	290	10	35	105	220	290	290	290	290		
Race	Refused	1	75	*	*	75	75	75	75	75	75	75	75	75	75		
Hispanic	No	278	184.917	184.467	11.064	2	1080	10	35	120	300	425	525	690	840		
Hispanic	Yes	9	160.556	180.666	60.222	10	575	10	60	60	210	575	575	575	575		
Hispanic	DK	1	375	*	*	375	375	375	375	375	375	375	375	375	375		
Employment	*	17	110.176	97.439	23.632	10	345	10	30	90	180	285	345	345	345		
Employment	Full Time	140	199.993	206.025	17.412	5	1080	8.5	60	120	297.5	470	600	840	900		
Employment	Part Time	27	167.963	153.74	29.587	5	490	10	25	120	302	390	434	490	490		
Employment	Not Employed	102	183.314	169.14	16.747	2	670	10	30	120	315	420	480	526	600		
Employment	Refused	2	61	83.439	59	2	120	2	2	61	120	120	120	120	120		
Education	*	18	110.722	94.558	22.287	10	345	10	30	90	180	285	345	345	345		
Education	< High School	23	214.348	215.017	44.834	15	900	30	45	120	360	480	490	900	900		
Education	High School Graduate	90	194.4	196.472	20.71	3	840	5	30	132.5	300	447	575	780	840		
Education	< College	64	202.156	200.764	25.095	2	1080	10	32.5	130	355	420	480	600	1080		
Education	College Graduate	54	169	154.537	21.03	5	525	10	60	97.5	270	425	490	510	525		
Education	Post Graduate	39	172.923	174.213	27.896	2	690	7	38	120	270	420	600	690	690		
Census Region	Northeast	55	166.164	181.344	24.452	3	840	5	30	75	210	415	525	600	840		
Census Region	Midwest	77	188.909	170.219	19.398	10	780	15	60	120	315	420	460	670	780		
Census Region	South	89	202.281	212.332	22.507	2	1080	10	30	120	315	480	570	900	1080		
Census Region	West	67	172.224	161.66	19.75	2	750	7	60	120	243	340	526	690	750		
Day Of Week	Weekday	188	178.213	171.94	12.54	2	780	10	42.5	110	300	430	490	600	750		
Day Of Week	Weekend	100	197.23	205.392	20.539	3	1080	5	32.5	145	296.5	420	585	870	990		
Season	Winter	62	167.097	172.076	21.854	3	600	5	15	90	300	445	490	540	600		
Season	Spring	65	203.123	216.629	26.87	5	900	10	45	120	300	480	670	840	900		
Season	Summer	95	180.442	182.013	18.674	2	1080	10	60	120	290	390	510	750	1080		
Season	Fall	66	189.727	164.551	20.255	2	600	10	55	120	330	420	435	600	600		
Asthma	No	264	180.33	183.699	11.306	2	1080	10	36.5	120	288.5	420	525	690	840		
Asthma	Yes	24	234.167	185.283	37.821	5	670	10	45	210	352.5	480	510	670	670		
Angina	No	281	179.687	175.258	10.455	2	900	10	30	120	295	420	490	670	780		
Angina	Yes	6	448.333	369.995	151.05	90	1080	90	100	410	600	1080	1080	1080	1080		
Angina	DK	1	45	*	*	45	45	45	45	45	45	45	45	45	45		
Bronchitis/emphysema	No	276	184.681	185.591	11.171	2	1080	10	36.5	120	299	430	526	690	840		
Bronchitis/emphysema	Yes	12	187.917	152.591	44.049	5	405	5	45	165	350	360	405	405	405		

Note: A "\*" Signifies missing data. "DK" = The respondent replied "don't know". Refused = Refused data. N = doer sample size. Mean = Mean 24-hour cumulative number of minutes for doers. Stdev = standard deviation. Stderr = standard error. Min = minimum number of minutes. Max = maximum number of minutes. Percentiles are the percentage of doers below or equal to a given number of minutes. Source: Tsang and Klepeis, 1996.



Table 15-76. Statistics for 24-Hour Cumulative Number of Minutes Spent in Plant Care

Category	Population Group	N	Mean	Stdev	Stderr	Min	Max	Percentiles								
								5	25	50	75	90	95	98	99	
All		254	103.602	108.761	6.824	3	630	10	30	60	130	225	300	480	570	
Gender	Male	84	146.274	145.969	15.926	10	630	15	32.5	105	195	380	480	570	630	
Gender	Female	170	82.518	76.759	5.887	3	630	10	30	60	120	180	210	270	325	
Age (years)	*	4	51.25	24.622	12.311	15	70	15	37.5	60	65	70	70	70	70	
Age (years)	5-11	5	121	120.955	54.093	35	330	35	60	60	120	330	330	330	330	
Age (years)	12-17	3	51	61.262	35.369	3	120	3	3	30	120	120	120	120	120	
Age (years)	18-64	157	100.49	104.921	8.374	5	570	10	30	60	135	225	300	475	565	
Age (years)	> 64	85	112.647	118.439	12.846	5	630	10	35	75	135	240	280	630	630	
Race	White	233	102.124	106.695	6.99	3	630	10	30	60	120	225	300	480	570	
Race	Black	8	81.25	90.149	31.872	15	280	15	15	50	112.5	280	280	280	280	
Race	Asian	3	140	45.826	26.458	90	180	90	90	150	180	180	180	180	180	
Race	Some Others	2	137.5	187.383	132.5	5	270	5	5	138	270	270	270	270	270	
Race	Hispanic	6	164.167	209.796	85.649	15	565	15	15	90	210	565	565	565	565	
Race	Refused	2	95	49.497	35	60	130	60	60	95	130	130	130	130	130	
Hispanic	No	244	102.971	106.161	6.796	3	630	10	30	60	132.5	225	280	480	570	
Hispanic	Yes	7	149.286	195.521	73.9	15	565	15	15	60	210	565	565	565	565	
Hispanic	DK	1	60	*	*	60	60	60	60	60	60	60	60	60	60	
Hispanic	Refused	2	42.5	24.749	17.5	25	60	25	25	42.5	60	60	60	60	60	
Employment	*	8	94.75	103.657	36.648	3	330	3	32.5	60	120	330	330	330	330	
Employment	Full Time	94	94.436	111.848	11.536	5	630	10	30	60	120	195	325	570	630	
Employment	Part Time	25	112.2	104.812	20.962	15	485	15	30	90	150	210	270	485	485	
Employment	Not Employed	124	108.387	108.655	9.758	5	630	10	40	72.5	127.5	240	270	480	565	
Employment	Refused	3	145	99.875	57.663	60	255	60	60	120	255	255	255	255	255	
Education	*	9	86.444	100.113	33.371	3	330	3	30	60	120	330	330	330	330	
Education	< High School	30	92.333	108.753	19.855	10	475	10	15	60	120	170	420	475	475	
Education	High School Graduate	93	87.656	95.248	9.877	5	565	10	30	60	120	180	255	480	565	
Education	< College	47	118.298	112.855	16.462	5	630	10	50	90	150	240	240	630	630	
Education	College Graduate	35	139	107.818	18.225	15	485	15	55	120	195	280	325	485	485	
Education	Post Graduate	40	104.75	131.036	20.719	15	630	15	30	60	120	217.5	420	630	630	
Census Region	Northeast	55	116.055	116.677	15.733	3	485	10	30	70	150	250	420	480	485	
Census Region	Midwest	41	101.659	109.248	17.062	5	630	30	30	60	120	195	270	630	630	
Census Region	South	77	82.078	76.081	8.67	5	475	10	30	60	120	175	225	300	475	
Census Region	West	81	116.593	126.602	14.067	10	630	14	30	75	150	240	330	570	630	
Day Of Week	Weekday	170	104.559	105.561	8.096	3	630	14	30	60	130	225	280	480	565	
Day Of Week	Weekend	84	101.667	115.595	12.612	5	630	10	30	60	127.5	240	325	570	630	
Season	Winter	15	135.333	170.592	44.047	5	565	5	30	60	175	485	565	565	565	
Season	Spring	96	124.323	108.656	11.09	5	570	15	45	90	150	270	330	475	570	
Season	Summer	111	89.82	100.882	9.575	3	630	10	30	60	120	190	225	420	630	
Season	Fall	32	74.375	87.894	15.538	5	480	10	25	47.5	102.5	135	195	480	480	
Asthma	No	239	105	108.541	7.021	3	630	10	30	60	135	235	300	485	570	
Asthma	Yes	15	81.333	113.68	29.352	5	450	5	15	55	90	175	450	450	450	
Angina	No	240	103.083	107.762	6.956	3	630	10	30	60	125	225	290	480	570	
Angina	Yes	13	120.769	130.286	36.135	15	485	15	55	60	135	270	485	485	485	
Angina	DK	1	5	*	*	5	5	5	5	5	5	5	5	5	5	
Bronchitis/emphysema	No	248	105.202	109.525	6.955	3	630	10	30	60	135	235	300	485	570	
Bronchitis/emphysema	Yes	6	37.5	24.238	9.895	5	60	5	15	42.5	60	60	60	60	60	

Note: A "\*" Signifies missing data. "DK" = The respondent replied "don't know". Refused = Refused data. N = doer sample size. Mean = Mean 24-hour cumulative number of minutes for doers. Stdev = standard deviation. Stderr = standard error. Min = minimum number of minutes. Max = maximum number of minutes. Percentiles are the percentage of doers below or equal to a given number of minutes. Source: Tsang and Klepeis, 1996.



Table 15-77. Statistics for 24-Hour Cumulative Number of Minutes Spent in Animal Care

Category	Population Group	N	Mean	Stdev	Stderr	Min	Max	Percentiles							
								5	25	50	75	90	95	98	99
All		764	48.168	65.029	2.3527	1	760	5	10	30	60	120	155	230	312
Gender	Male	282	57.291	81.786	4.8703	1	760	5	15	30	65	120	180	308	340
Gender	Female	482	42.83	52.182	2.3768	1	450	3	10	28.5	60	105	140	187	273
Age (years)	*	13	37.462	38.606	10.7074	2	135	2	5	30	55	80	135	135	135
Age (years)	1-4	9	59.222	44.291	14.7637	3	140	3	30	60	90	140	140	140	140
Age (years)	5-11	27	47.296	43.1	8.2946	2	179	8	15	38	65	120	150	179	179
Age (years)	12-17	49	55.204	68.276	9.7537	3	308	5	10	25	90	175	180	308	308
Age (years)	18-64	530	45.928	66.581	2.8921	1	760	3	10	30	60	109	150	230	280
Age (years)	> 64	136	54.824	64.527	5.5331	1	383	5	15	30	60	135	180	340	340
Race	White	696	47.757	62.011	2.3505	1	760	4	10	30	60	120	155	240	312
Race	Black	26	37.577	39.832	7.8117	1	145	1	10	25	45	120	120	145	145
Race	Asian	5	30.4	21.87	9.7806	10	60	10	15	20	47	60	60	60	60
Race	Some Others	12	100	193.567	55.878	5	690	5	17.5	30	65	205	690	690	690
Race	Hispanic	17	37.765	44.992	10.9123	5	180	5	15	30	35	120	180	180	180
Race	Refused	8	73.75	58.478	20.675	5	180	5	32.5	55	115	180	180	180	180
Hispanic	No	712	47.81	61.479	2.304	1	760	4	10	30	60	120	151	230	308
Hispanic	Yes	39	50.872	112.78	18.0593	2	690	3	10	20	35	120	180	690	690
Hispanic	DK	6	50	77.071	31.4643	10	205	10	10	15	45	205	205	205	205
Hispanic	Refused	7	67.857	62.039	23.4485	5	180	5	20	60	120	180	180	180	180
Employment	*	86	51.221	56.803	6.1252	2	308	5	15	30	70	120	175	240	308
Employment	Full Time	376	44.918	71.458	3.6852	1	760	3	10	25	60	90	145	240	340
Employment	Part Time	60	48.883	56.285	7.2664	3	230	5	12.5	20	60	152.5	176.5	205	230
Employment	Not Employed	233	52.459	59.357	3.8886	1	383	5	15	30	60	120	180	273	330
Employment	Refused	9	38.889	53.897	17.9656	5	180	5	20	30	30	180	180	180	180
Education	*	98	52.347	57.02	5.7599	2	308	5	15	30	70	140	180	240	308
Education	< High School	63	51.492	68.122	8.5825	1	383	5	15	30	60	120	225	273	383
Education	High School Graduate	231	52.913	75.819	4.9885	1	760	5	10	30	70	120	165	245	330
Education	< College	150	40.593	49.247	4.021	1	280	4	10	20	55	97.5	155	205	230
Education	College Graduate	121	51.273	79.213	7.2012	1	690	3	15	30	60	110	135	340	340
Education	Post Graduate	101	38.713	40.069	3.987	1	240	5	12	30	57	80	105	150	185
Census Region	Northeast	171	39.789	44.88	3.432	1	273	3	10	25	60	90	120	205	245
Census Region	Midwest	181	49.773	58.716	4.3644	1	330	4	14	30	60	120	180	240	312
Census Region	South	247	51.389	75.022	4.7736	1	760	5	15	30	60	120	165	308	383
Census Region	West	165	50.267	72.551	5.6481	1	690	3	10	30	60	120	155	210	340
Day Of Week	Weekday	527	46.602	66.468	2.8954	1	760	4	10	30	60	115	155	195	280
Day Of Week	Weekend	237	51.65	61.703	4.0081	1	383	5	15	30	60	120	180	273	330
Season	Winter	221	44.62	66.372	4.4647	1	690	4	10	25	55	95	160	225	245
Season	Spring	201	52.99	60.351	4.2568	1	340	5	15	30	60	120	175	240	330
Season	Summer	216	51.426	76.405	5.1987	1	760	5	15	30	64	120	165	240	383
Season	Fall	126	41.111	45.413	4.0457	1	280	3	10	25	60	110	135	180	180
Asthma	No	705	48.401	65.505	2.4671	1	760	4	10	30	60	120	155	225	308
Asthma	Yes	57	45.386	60.468	8.0091	1	330	5	10	30	55	105	195	240	330
Asthma	DK	2	45	21.213	15	30	60	30	30	45	60	60	60	60	60
Angina	No	734	47.834	64.308	2.3737	1	760	5	10	30	60	120	155	225	280
Angina	Yes	27	58.704	85.601	16.474	2	340	3	15	30	60	135	330	340	340
Angina	DK	3	35	22.913	13.2288	15	60	15	15	30	60	60	60	60	60
Bronchitis/emphysema	No	718	48.357	65.56	2.4467	1	760	4	10	30	60	120	160	230	308
Bronchitis/emphysema	Yes	43	45.395	58.522	8.9245	2	330	5	10	30	55	90	150	330	330
Bronchitis/emphysema	DK	3	42.667	15.535	8.9691	30	60	30	30	38	60	60	60	60	60

Note: A "\*" Signifies missing data. "DK" = The respondent replied "don't know". Refused = Refused data. N = doer sample size. Mean = Mean 24-hour cumulative number of minutes for doers. Stdev = standard deviation. Stderr = standard error. Min = minimum number of minutes. Max = maximum number of minutes. Percentiles are the percentage of doers below or equal to a given number of minutes. Source: Tsang and Klepeis, 1996.



Table 15-78. Statistics for 24-Hour Cumulative Number of Minutes Spent in Other Household Work

Group Name	Group Code	N	Mean	Stdev	Stderr	Min	Max	Percentiles								
								5	25	50	75	90	95	98	99	
All		1322	68.6354	98.697	2.7145	1	905	5	15	30	75	195	255	360	480	
Gender	Male	478	70.3661	101.833	4.6577	1	905	5	10	30	90	195	265	375	480	
Gender	Female	844	67.6552	96.923	3.3362	1	720	5	15	30	75	190	255	360	496	
Age (years)	*	21	93.4286	113.994	24.8756	4	403	5	15	30	180	225	300	403	403	
Age (years)	1-4	15	57.1333	85.7	22.1277	1	290	1	6	25	60	230	290	290	290	
Age (years)	5-11	56	24.9464	30.134	4.0269	1	150	2	5	12.5	30	60	90	120	150	
Age (years)	12-17	84	39.4762	51.785	5.6502	1	230	2	5	16.5	50	120	150	210	230	
Age (years)	18-64	918	71.2353	101.54	3.3513	1	905	5	15	30	90	195	265	375	540	
Age (years)	> 64	228	78.114	106.158	7.0305	1	665	5	14.5	30	90	225	295	420	480	
Race	White	1118	70.6977	98.015	2.9314	1	720	5	15	30	80	195	265	375	480	
Race	Black	102	46.1176	65.201	6.4558	1	300	3	10	15	50	120	210	255	260	
Race	Asian	20	71.9	76.619	17.1324	1	315	1.5	22.5	60	105	162.5	260	315	315	
Race	Some Others	22	67.7727	190.288	40.5695	1	905	2	10	15	30	90	155	905	905	
Race	Hispanic	43	65.6512	118.419	18.0587	5	660	5	10	20	60	155	270	660	660	
Race	Refused	17	72.9412	108.744	26.3742	5	420	5	15	20	75	210	420	420	420	
Hispanic	No	1218	67.8342	93.324	2.674	1	720	5	15	30	75	195	255	358	420	
Hispanic	Yes	81	80.5185	159.202	17.6891	1	905	5	10	20	60	155	360	665	905	
Hispanic	DK	7	54.1429	74.627	28.2062	1	210	1	10	25	90	210	210	210	210	
Hispanic	Refused	16	75.8125	113.469	28.3673	5	420	5	15	25	82.5	233	420	420	420	
Employment	*	153	37.0196	52.694	4.2601	1	290	2	5	15	45	90	150	225	230	
Employment	Full Time	555	70.0342	103.005	4.3723	1	905	5	15	30	85	195	265	375	540	
Employment	Part Time	124	62.0726	86.315	7.7513	2	420	5	15	30	65	190	240	400	403	
Employment	Not Employed	482	78.3008	105.529	4.8067	1	685	5	15	30	100	224	270	420	575	
Employment	Refused	8	95.625	110.014	38.8959	5	300	5	17.5	32.5	180	300	300	300	300	
Education	*	175	42.7086	64.901	4.906	1	450	2	5	15	45	120	192	233	300	
Education	< High School	96	82.5313	114.62	11.6983	1	660	5	15	30	117.5	240	328	420	660	
Education	High School Graduate	418	75.5574	105.946	5.182	1	720	5	15	30	90	215	270	420	540	
Education	< College	290	71.3724	100.836	5.9213	1	905	5	15	30	100	192.5	270	330	375	
Education	College Graduate	196	73.6173	104.18	7.4414	1	600	5	15	30	85	190	330	400	585	
Education	Post Graduate	147	58.7007	81.662	6.7354	1	570	4	10	30	65	150	210	315	420	
Census Region	Northeast	307	62.8632	91.306	5.2111	1	665	5	15	30	63	180	255	360	400	
Census Region	Midwest	318	70.8679	98.179	5.5056	1	590	5	15	30	90	180	270	375	570	
Census Region	South	394	74.7056	106.703	5.3756	1	720	5	10	30	85	215	296	380	600	
Census Region	West	303	64.2475	95.504	5.4866	1	905	5	13	30	75	180	240	330	420	
Day Of Week	Weekday	857	71.5496	106.351	3.6329	1	905	5	10	30	85	210	295	380	570	
Day Of Week	Weekend	465	63.2645	82.596	3.8303	1	600	5	15	30	75	170	225	296	403	
Season	Winter	353	64.1558	91.547	4.8726	1	590	5	15	30	65	195	240	345	480	
Season	Spring	327	82.844	118.992	6.5803	1	905	5	15	30	115	240	305	420	585	
Season	Summer	391	62.1125	97.341	4.9227	1	685	5	10	30	60	160	255	400	570	
Season	Fall	251	66.5857	77.867	4.9149	1	480	5	15	35	90	180	230	292	345	
Asthma	No	1211	67.8423	98.123	2.8197	1	905	5	15	30	75	190	255	360	480	
Asthma	Yes	103	75.6893	104.033	10.2507	1	575	5	15	30	100	210	240	400	480	
Asthma	DK	8	97.875	120.21	42.5006	5	300	5	15	17.5	206.5	300	300	300	300	
Angina	No	1269	68.2041	99.025	2.7798	1	905	5	15	30	75	190	255	375	496	
Angina	Yes	44	77.1364	86.104	12.9807	5	300	5	10	30	132.5	220	240	300	300	
Angina	DK	9	87.8889	116.368	38.7895	5	300	5	15	15	180	300	300	300	300	
Bronchitis/Emphysema	No	1247	67.8043	97.936	2.7734	1	905	5	15	30	75	190	255	360	480	
Bronchitis/Emphysema	Yes	64	83.4844	111.726	13.9658	1	575	5	15	32.5	117.5	220	265	480	575	
Bronchitis/Emphysema	DK	11	76.4545	107.17	32.3131	5	300	5	15	20	180	233	300	300	300	

Note: A "\*" Signifies missing data. "DK" = The respondent replied "don't know". Refused = Refused data. N = doer sample size. Mean = Mean 24-hour cumulative number of minutes for doers. Stdev = standard deviation. Stderr = standard error. Min = minimum number of minutes. Max = maximum number of minutes. Percentiles are the percentage of doers below or equal to a given number of minutes. Source: Tsang and Klepeis, 1996.





Table 15-79. Statistics for 24-Hour Cumulative Number of Minutes Spent in Indoor Playing

Category	Population Group	N	Mean	Stdev	Stderr	Min	Max	Percentiles							
								5	25	50	75	90	95	98	99
All		188	105	82.7	6.03	2	510	20	55	90	127.5	190	270	390	435
Gender	Male	65	117	97.1	12	10	510	20	60	90	135	255	300	435	510
Gender	Female	123	99.5	73.8	6.65	2	420	20	55	76	120	190	225	340	375
Age (years)	*	3	127	47.3	27.3	90	180	90	90	110	180	180	180	180	180
Age (years)	1-4	11	130	80.2	24.2	15	270	15	60	115	180	255	270	270	270
Age (years)	5-11	11	93.6	64.3	19.4	30	195	30	30	60	175	180	195	195	195
Age (years)	12-17	4	82.5	45	22.5	30	120	30	45	90	120	120	120	120	120
Age (years)	18-64	149	103	86	7.05	2	510	20	55	76	120	190	292	420	435
Age (years)	> 64	10	124	76.4	24.2	20	270	20	75	100	150	248	270	270	270
Race	White	153	110	84.3	6.82	2	510	20	60	90	130	190	270	390	435
Race	Black	13	95	84.8	23.5	15	255	15	30	60	180	220	255	255	255
Race	Asian	5	71	56.8	25.4	10	150	10	30	60	105	150	150	150	150
Race	Some Others	7	108	96.5	36.5	30	300	30	55	60	175	300	300	300	300
Race	Hispanic	8	68.4	46.4	16.4	42	180	42	45	50	67.5	180	180	180	180
Race	Refused	2	64	65.1	46	18	110	18	18	64	110	110	110	110	110
Hispanic	No	172	107	83.9	6.4	2	510	20	60	90	132.5	190	270	390	435
Hispanic	Yes	15	88.1	71.4	18.4	42	300	42	45	60	100	180	300	300	300
Hispanic	Refused	1	110	*	*	110	110	110	110	110	110	110	110	110	110
Employment	*	26	108	69.9	13.7	15	270	30	55	105	160	195	255	270	270
Employment	Full Time	74	102	95	11	2	510	15	45	70	125	195	300	435	510
Employment	Part Time	20	124	74	16.6	30	340	36	60	120	165	200	280	340	340
Employment	Not Employed	68	102	76	9.21	15	420	30	60	85	120	180	245	390	420
Education	*	27	108	68.6	13.2	15	270	30	55	110	160	195	255	270	270
Education	< High School	16	89.4	58.8	14.7	20	220	20	52.5	60	125	180	220	220	220
Education	High School Graduate	59	102	83.6	10.9	2	435	20	55	75	135	180	340	375	435
Education	< College	33	112	97.7	17	10	510	20	55	90	120	190	300	510	510
Education	College Graduate	37	125	96.1	15.8	15	420	15	60	105	155	270	390	420	420
Education	Post Graduate	16	72.5	40.4	10.1	10	150	10	37.5	65	102.5	120	150	150	150
Census Region	Northeast	46	110	94.4	13.9	2	420	20	60	75	120	245	375	420	420
Census Region	Midwest	40	111	75.8	12	15	340	17.5	50	95	175	193	256	340	340
Census Region	South	64	100	73	9.13	10	435	30	52.5	87.5	127.5	180	225	270	435
Census Region	West	38	102	92.2	15	10	510	18	60	60	120	180	300	510	510
Day Of Week	Weekday	128	99.4	71	6.27	2	435	20	55	90	120	180	245	300	340
Day Of Week	Weekend	60	118	13	13.3	15	510	30	60	90	150	245	382.5	420	510
Season	Winter	49	130	99.2	14.2	18	420	20	60	105	180	300	375	420	420
Season	Spring	36	85.7	55.7	9.28	2	270	20	45	77.5	112.5	155	180	270	270
Season	Summer	47	92.7	77	11.2	10	435	30	45	60	120	180	195	435	435
Season	Fall	56	107	82.7	11	10	510	15	60	90	127.5	195	255	270	510
Asthma	No	174	107	84.1	6.38	2	510	20	55	90	130	190	270	390	435
Asthma	Yes	13	88.5	66.4	18.4	20	245	20	30	75	120	180	245	245	245
Asthma	DK	1	110	*	*	110	110	110	110	110	110	110	110	110	110
Angina	No	184	104	80.7	5.95	2	510	20	55	90	122.5	190	270	375	435
Angina	Yes	3	210	167	96.4	60	390	60	60	180	390	390	390	390	390
Angina	DK	1	110	*	*	110	110	110	110	110	110	110	110	110	110
Bronchitis/emphysema	No	177	107	83.5	6.27	2	510	20	60	90	130	190	270	390	435
Bronchitis/emphysema	Yes	10	80.1	72.5	22.9	10	245	10	30	60	76	208	245	245	245
Bronchitis/emphysema	DK	1	110	*	*	110	110	110	110	110	110	110	110	110	110

Note: A "\*" Signifies missing data. "DK" = The respondent replied "don't know". Refused = Refused data. N = doer sample size. Mean = Mean 24-hour cumulative number of minutes for doers. Stdev = standard deviation. Stderr = standard error. Min = minimum number of minutes. Max = maximum number of minutes. Percentiles are the percentage of doers below or equal to a given number of minutes.  
 Source: Tsang and Klepeis, 1996.



Table 15-80. Statistics for 24-Hour Cumulative Number of Minutes Spent in Outdoor Playing

Category	Population Group	N	Mean	Stdev	Stderr	Min	Max	Percentiles							
								5	25	50	75	90	95	98	99
All		59	97.373	95.372	12.416	5	435	15	45	60	110	210	360	420	435
Gender	Male	26	108.192	94.783	18.588	15	360	15	60	75	135	280	345	360	360
Gender	Female	33	88.848	96.425	16.785	5	435	5	45	60	100	150	420	435	435
Age (years)	*	1	170	*	*	170	170	170	170	170	170	170	170	170	170
Age (years)	1-4	4	83.25	89.66	44.83	15	210	15	20	54	146.5	210	210	210	210
Age (years)	5-11	9	148.333	144.265	48.088	5	360	5	55	60	280	360	360	360	360
Age (years)	12-17	1	15	*	*	15	15	15	15	15	15	15	15	15	15
Age (years)	18-64	40	92.05	86.358	13.654	20	435	27.5	52.5	65	102.5	142.5	307	435	435
Age (years)	> 64	4	52.5	15	7.5	30	60	30	45	60	60	60	60	60	60
Race	White	50	93.94	90.208	12.757	5	420	15	45	60	100	202	345	390	420
Race	Black	2	86.5	37.477	26.5	60	113	60	60	86.5	113	113	113	113	113
Race	Asian	1	100	*	*	100	100	100	100	100	100	100	100	100	100
Race	Some Others	1	30	*	*	30	30	30	30	30	30	30	30	30	30
Race	Hispanic	5	149	164.864	73.729	20	435	20	60	110	120	435	435	435	435
Hispanic	No	51	93.333	89.747	12.567	5	420	15	45	60	100	194	345	360	420
Hispanic	Yes	8	123.125	130.218	46.039	20	435	20	60	90	115	435	435	435	435
Employment	*	15	123.533	124.379	32.115	5	360	5	15	60	210	345	360	360	360
Employment	Full Time	15	67.2	30.887	7.975	20	135	20	45	60	85	113	135	135	135
Employment	Part Time	7	87.714	54.129	20.459	30	194	30	60	60	110	194	194	194	194
Employment	Not Employed	22	103.182	110.136	23.481	25	435	30	45	60	105	150	420	435	435
Education	*	15	123.533	124.379	32.115	5	360	5	15	60	210	345	360	360	360
Education	< High School	5	57	6.708	3	45	60	45	60	60	60	60	60	60	60
Education	High School Graduate	10	148.5	150.482	47.586	30	435	30	60	95	135	427.5	435	435	435
Education	< College	18	74.667	45.169	10.646	20	194	20	45	60	95	150	194	194	194
Education	College Graduate	8	75.375	35.492	12.548	30	120	30	45	75	106.5	120	120	120	120
Education	Post Graduate	3	58.333	24.664	14.24	30	75	30	30	70	75	75	75	75	75
Census Region	Northeast	17	114.059	103.26	25.044	15	360	15	60	70	120	345	360	360	360
Census Region	Midwest	12	78.583	32.354	9.34	30	150	30	60	65	97.5	113	150	150	150
Census Region	South	15	109.667	109.536	28.282	30	420	30	30	60	135	280	420	420	420
Census Region	West	15	81.2	107.674	27.801	5	435	5	20	60	105	165	435	435	435
Day Of Week	Weekday	42	86.81	79.211	12.223	5	360	15	30	60	100	165	280	360	360
Day Of Week	Weekend	17	123.471	126.007	30.561	25	435	25	45	60	120	420	435	435	435
Season	Winter	10	66.5	46.251	14.626	5	150	5	30	60	105	135	150	150	150
Season	Spring	10	135.3	114.735	36.283	45	435	45	60	108	165	302.5	435	435	435
Season	Summer	31	92.355	94.966	17.056	5	420	15	45	60	100	210	345	420	420
Season	Fall	8	108	115.681	40.899	25	360	25	30	67.5	142	360	360	360	360
Asthma	No	56	94.821	91.447	12.22	5	435	15	45	60	107.5	194	360	420	435
Asthma	Yes	3	145	173.853	100.374	30	345	30	30	60	345	345	345	345	345
Angina	No	58	96.983	96.158	12.626	5	435	15	45	60	105	210	360	420	435
Angina	Yes	1	120	*	*	120	120	120	120	120	120	120	120	120	120
Bronchitis/Emphysema	No	55	90.018	87.056	11.739	5	435	15	45	60	100	170	345	360	435
Bronchitis/Emphysema	Yes	4	198.5	157.509	78.754	60	420	60	90	157	307	420	420	420	420

Note: A "\*" Signifies missing data. "DK" = The respondent replied "don't know". N = doer sample size. Mean = Mean 24-hour cumulative number of minutes for doers. Stdev = standard deviation. Stderr = standard error. Min = minimum number of minutes. Max = maximum number of minutes. Percentiles are the percentage of doers below or equal to a given number of minutes. Source: Tsang and Klepeis, 1996.



Table 15-81. Statistics for 24-Hour Cumulative Number of Minutes Spent for Car Repair Services

Category	Population Group	N	Mean	Stdev	Stderr	Min	Max	Percentiles							
								5	25	50	75	90	95	98	99
All		259	33.7876	53.772	3.3413	1	358	5	5	10	30	90	180	195	270
Gender	Male	128	41.6953	65.45	5.7851	1	358	4	5	15	45	120	180	270	280
Gender	Female	131	26.0611	37.84	3.3061	2	180	5	5	10	30	65	105	180	180
Age (years)	*	2	88	2.828	2	86	90	86	86	88	90	90	90	90	90
Age (years)	1-4	8	33.125	43.666	15.438	5	115	5	5	12.5	55	115	115	115	115
Age (years)	5-11	6	18.3333	20.897	8.531	5	60	5	5	12.5	15	60	60	60	60
Age (years)	12-17	13	31.3077	32.638	9.0521	3	95	3	5	10	55	79	95	95	95
Age (years)	18-64	204	32.4853	52.731	3.6919	1	280	5	5	10	30	85	180	195	265
Age (years)	> 64	26	44.8462	75.446	14.796	1	358	2	10	15	50	105	180	358	358
Race	White	226	33.8451	51.028	3.3943	1	280	5	5	10	35	90	175	195	265
Race	Black	19	49.3158	90.675	20.802	1	358	1	5	10	44	180	358	358	358
Race	Asian	3	11.6667	11.547	6.6667	5	25	5	5	5	25	25	25	25	25
Race	Some Others	5	11	8.944	4	5	25	5	5	5	15	25	25	25	25
Race	Hispanic	6	12.5	6.124	2.5	5	20	5	5	15	15	20	20	20	20
Hispanic	No	247	34.6154	54.728	3.4822	1	358	5	5	10	35	90	180	245	270
Hispanic	Yes	12	16.75	22.471	6.4867	5	86	5	5	12.5	15	20	86	86	86
Employment	*	26	27.7692	33.586	6.5868	3	115	5	5	10	50	90	95	115	115
Employment	Full Time	137	31.8759	52.912	4.5206	1	280	4	5	10	30	85	175	265	270
Employment	Part Time	25	32.96	49.672	9.9344	5	180	5	7	15	30	105	180	180	180
Employment	Not Employed	70	40.4714	62.833	7.51	1	358	4	10	15	35	103	180	245	358
Employment	Refused	1	5	*	*	5	5	5	5	5	5	5	5	5	5
Education	*	28	28.4643	32.992	6.2349	3	115	5	5	12.5	52.5	90	95	115	115
Education	< High School	20	36.15	51.714	11.564	5	180	5	10	15	45	117.5	177.5	180	180
Education	High School Graduate	64	41.0781	62.959	7.8698	2	280	5	5	15	47.5	105	180	265	280
Education	< College	68	36.2206	59.709	7.2407	1	358	2	5	15	37.5	90	180	180	358
Education	College Graduate	41	29.6829	54.536	8.5171	1	270	4	5	10	25	60	160	270	270
Education	Post Graduate	38	24.2632	36.541	5.9277	5	195	5	5	10	20	70	95	195	195
Census Region	Northeast	45	40.4889	58.498	8.7204	2	270	5	5	15	60	105	180	270	270
Census Region	Midwest	66	34.6364	56.367	6.9383	2	280	5	5	10	35	70	180	265	280
Census Region	South	88	34.8182	60.547	6.4543	1	358	3	5	10	30	95	180	245	358
Census Region	West	60	26.3167	33.054	4.2673	4	175	5	5	12.5	30	80	95.5	115	175
Day Of Week	Weekday	176	36.0227	57.142	4.3072	1	358	5	5	15	30	101	180	265	280
Day Of Week	Weekend	83	29.0482	45.78	5.025	1	245	3	5	10	30	79	95	195	245
Season	Winter	70	19.4857	27.784	3.3208	1	180	2	5	10	20	60	60	90	180
Season	Spring	70	36.5286	48.821	5.8352	2	245	5	5	15	50	105	150	180	245
Season	Summer	79	41.5316	66.665	7.5004	2	358	5	5	15	30	160	180	270	358
Season	Fall	40	38.725	64.266	10.161	2	280	5	5	12.5	39.5	90.5	222.5	280	280
Asthma	No	238	34.7731	55.08	3.5703	1	358	4	5	10	35	90	180	245	270
Asthma	Yes	21	22.619	34.735	7.5799	5	150	5	5	15	15	35	90	150	150
Angina	No	253	32.6324	51.888	3.2622	1	358	5	5	10	30	90	160	180	270
Angina	Yes	6	82.5	102.896	42.007	10	245	10	15	22.5	180	245	245	245	245
Bronchitis/emphysema	No	247	33.0607	52.903	3.3661	1	358	5	5	10	30	90	175	195	270
Bronchitis/emphysema	Yes	12	48.75	70.522	20.358	5	245	5	5	15	77.5	95	245	245	245

Note: A "\*" Signifies missing data. "DK" = The respondent replied "don't know". Refused = Refused data. N = doer sample size. Mean = Mean 24-hour cumulative number of minutes for doers. Stdev = standard deviation. Stderr = standard error. Min = minimum number of minutes. Max = maximum number of minutes. Percentiles are the percentage of doers below or equal to a given number of minutes.  
 Source: Tsang and Klepeis, 1996.



Table 15-82. Statistics for 24-Hour Cumulative Number of Minutes Spent Washing, etc.

Category	Population Group	N	Mean	Stdev	Stderr	Min	Max	Percentiles										
								5	25	50	75	90	95	98	99			
All		6029	23.9338	25.5661	0.3293	1	705	5	10	20	30	45	60	75	90			
Gender	Male	2785	23.4154	28.8168	0.5461	1	705	5	10	15	30	45	55	65	90			
Gender	Female	3242	24.3816	22.4026	0.3935	1	555	5	10	20	30	45	60	80	90			
Gender	Refused	2	20	14.1421	10	10	30	10	10	20	30	30	30	30	30			
Age (years)	*	110	25.9182	30.4752	2.9057	3	300	5	10	20	30	41.5	60	60	80			
Age (years)	1-4	318	29.2673	16.5524	0.9282	5	125	10	15	30	30	50	60	75	85			
Age (years)	5-11	407	26.5184	35.9626	1.7826	2	690	7	15	20	30	45	60	60	75			
Age (years)	12-17	411	22.4088	14.6309	0.7217	1	90	5	10	18	30	42	50	60	60			
Age (years)	18-64	4154	22.7939	21.6279	0.3356	1	555	5	10	15	30	45	60	75	90			
Age (years)	> 64	629	27.7424	43.1415	1.7202	1	705	5	12	20	30	45	65	90	120			
Race	White	4794	23.1558	26.1288	0.3774	1	705	5	10	15	30	45	60	70	90			
Race	Black	664	28.7816	24.2016	0.9392	3	270	5	15	20	35	60	65	90	105			
Race	Asian	110	24.4727	17.5493	1.6733	5	90	5	15	20	30	47.5	60	85	90			
Race	Some Others	119	28.6471	27.4768	2.5188	3	240	8	15	25	30	50	60	100	150			
Race	Hispanic	269	23.8364	19.8318	1.2092	1	210	5	10	20	30	45	60	75	90			
Race	Refused	73	22.7945	20.46	2.3947	3	105	5	10	15	30	60	75	90	105			
Hispanic	No	5476	23.8088	25.0872	0.339	1	705	5	10	20	30	45	60	75	90			
Hispanic	Yes	465	25.7312	31.6942	1.4698	1	570	5	15	20	30	45	60	75	90			
Hispanic	DK	30	23.8	15.0319	2.7444	5	60	10	15	17.5	30	50	60	60	60			
Hispanic	Refused	58	21.3966	18.5708	2.4385	5	105	5	10	15	25	30	60	80	105			
Employment	*	1116	25.9758	25.169	0.7534	1	690	7	15	20	30	45	60	60	75			
Employment	Full Time	2975	22.0733	21.4639	0.3935	1	555	5	10	15	30	45	60	65	85			
Employment	Part Time	518	22.3996	17.1137	0.7519	1	135	5	10	15	30	45	60	70	90			
Employment	Not Employed	1378	26.9354	34.8572	0.939	1	705	5	10	20	30	50	60	90	120			
Employment	Refused	42	21.9048	15.8865	2.4513	5	90	5	10	15	30	30	45	90	90			
Education	*	1245	25.3888	24.2988	0.6887	1	690	6	15	20	30	45	60	60	80			
Education	< High School	440	30.6	46.38	2.2111	1	570	5	15	20	30	50	60	90	240			
Education	High School Graduate	1634	23.7699	20.0081	0.495	1	270	5	10	20	30	45	60	75	90			
Education	< College	1228	22.8575	19.6959	0.5621	1	255	5	10	15	30	45	60	75	90			
Education	College Graduate	844	22.5936	32.3617	1.1139	1	705	5	10	15	30	40	60	75	110			
Education	Post Graduate	638	20.7618	18.4597	0.7308	2	240	5	10	15	30	45	60	65	85			
Census Region	Northeast	1356	23.3274	21.7583	0.5909	1	360	5	10	15	30	45	60	75	90			
Census Region	Midwest	1303	22.9294	27.432	0.76	1	570	5	10	15	30	45	60	70	85			
Census Region	South	2136	25.2116	21.6627	0.4687	1	300	5	15	20	30	45	60	85	105			
Census Region	West	1234	23.4489	32.6116	0.9284	1	705	5	10	15	30	45	60	65	85			
Day Of Week	Weekday	4184	22.9441	25.7284	0.3978	1	705	5	10	15	30	45	60	65	90			
Day Of Week	Weekend	1845	26.1783	25.0567	0.5833	1	555	5	15	20	30	50	60	90	100			
Season	Winter	1688	24.6226	20.295	0.494	1	300	5	10	20	30	45	60	75	90			
Season	Spring	1584	26.3295	38.468	0.9665	1	705	5	13	20	30	45	60	90	125			
Season	Summer	1636	21.8264	15.5411	0.3842	1	150	5	10	15	30	40	55	60	75			
Season	Fall	1121	22.587	20.8871	0.6238	1	340	5	10	15	30	45	60	75	90			
Asthma	No	5559	23.9538	26.1095	0.3502	1	705	5	10	20	30	45	60	75	90			
Asthma	Yes	437	24.2288	18.3575	0.8782	1	145	5	15	20	30	45	60	90	95			
Asthma	DK	33	16.6667	8.7202	1.518	5	30	5	10	15	25	30	30	30	30			
Angina	No	5866	23.9529	25.8029	0.3369	1	705	5	10	20	30	45	60	75	90			
Angina	Yes	125	25.176	15.6613	1.4008	3	100	6	15	25	30	45	60	60	75			
Angina	DK	38	16.8947	8.5481	1.3867	5	35	5	10	15	25	30	30	35	35			
Bronchitis/Emphysema	No	5749	23.8629	25.8064	0.3404	1	705	5	10	20	30	45	60	75	90			
Bronchitis/Emphysema	Yes	249	26.49	20.7475	1.3148	1	150	5	15	20	30	60	60	95	105			
Bronchitis/Emphysema	DK	31	16.5484	8.0616	1.4479	5	30	5	10	15	25	30	30	30	30			

Note: A "\*" Signifies missing data. "DK" = The respondent replied "don't know". Refused = Refused data. N = doer sample size. Mean = Mean 24-hour cumulative number of minutes for doers. Stdev = standard deviation. Stderr = standard error. Min = minimum number of minutes. Max = maximum number of minutes. Percentiles are the percentage of doers below or equal to a given number of minutes.  
Source: Tsang and Klepeis, 1996.



Table 15-83. Statistics for 24-Hour Cumulative Number of Minutes Spent Sleeping/Napping

Category	Population Group	N	Mean	Stdev	Stderr	Min	Max	Percentiles								
								5	25	50	75	90	95	98	99	
All		9362	526.287	134.435	1.3894	30	1430	345	445	510	600	690	760	850	925	
Gender	Male	4283	523.333	135.183	2.0656	30	1295	330	435	510	600	690	765	860	925	
Gender	Female	5075	528.685	133.743	1.8774	30	1430	350	450	510	600	690	750	840	925	
Gender	Refused	4	645	123.693	61.8466	540	780	540	540	630	750	780	780	780	780	
Age (years)	*	185	502.281	125.424	9.2214	195	908	330	420	480	555	655	745	865	900	
Age (years)	1-4	499	732.363	124.328	5.5657	270	1320	540	655	720	810	900	930	1005	1110	
Age (years)	5-11	702	625.058	100.656	3.799	120	1110	480	570	630	680	725	780	840	875	
Age (years)	12-17	588	563.719	110.83	4.5706	150	1015	395	484	550	630	705	750	810	900	
Age (years)	18-64	6041	496.93	123.019	1.5828	30	1420	330	420	480	555	630	705	780	868	
Age (years)	> 64	1347	517.084	117.477	3.2009	30	1430	345	450	510	570	660	720	780	860	
Race	White	7576	523.598	129.545	1.4883	30	1430	350	445	510	600	690	750	840	900	
Race	Black	940	541.303	162.726	5.3076	60	1415	315	424	530	630	737.5	822.5	940	1020	
Race	Asian	156	537.09	118.072	9.4533	300	920	345	467.5	540	600	690	735	840	870	
Race	Some Others	181	528.823	142.25	10.5734	60	905	300	420	525	630	720	769	810	842	
Race	Hispanic	383	537.966	148.886	7.6077	60	1125	315	450	540	630	720	765	870	930	
Race	Refused	126	523.421	143.695	12.8014	180	1140	330	420	510	600	720	780	870	930	
Hispanic	No	8514	525.205	133.218	1.4438	30	1430	345	445	510	600	690	750	855	925	
Hispanic	Yes	700	540.053	147.143	5.5615	60	1125	320	450	540	630	720	777.5	842.5	915	
Hispanic	DK	45	527.467	139.269	20.7609	195	842	345	420	515	659	690	710	842	842	
Hispanic	Refused	103	521.592	138.874	13.6837	240	930	330	420	510	590	720	780	865	870	
Employment	*	1771	636.604	128.545	3.0545	120	1320	440	555	630	705	802	860	930	975	
Employment	Full Time	4085	487.152	118.9	1.8603	30	1420	325	420	480	540	628	685	770	840	
Employment	Part Time	798	502.764	117.416	4.1565	60	1005	330	435	495	570	645	720	780	860	
Employment	Not Employed	2638	520.277	125.549	2.4444	30	1430	345	450	510	590	660	720	800	885	
Employment	Refused	70	513.671	136.491	16.3138	210	930	320	420	490	570	696.5	780	900	930	
Education	*	1966	625.586	133.976	3.0216	120	1420	420	540	628	699	790	855	926	975	
Education	< High School	832	515.445	135.697	4.7045	30	1317	300	435	510	585	670	750	860	900	
Education	High School Graduate	2604	505.367	123.006	2.4105	30	1430	330	420	495	570	659	720	780	840	
Education	< College	1791	496.616	119.862	2.8323	60	1350	315	420	480	565	630	690	779	845	
Education	College Graduate	1245	492.516	117.558	3.3317	75	1404	330	420	480	540	629	690	775	900	
Education	Post Graduate	924	486.737	110.394	3.6317	105	1295	345	420	480	540	615	660	725	800	
Census Region	Northeast	2068	523.129	133.703	2.9401	55	1420	345	435	510	600	690	760	860	930	
Census Region	Midwest	2096	520.846	127.642	2.788	30	1215	330	440	510	598	690	745	840	870	
Census Region	South	3234	529.019	135.651	2.3854	30	1430	345	450	510	600	699	765	855	925	
Census Region	West	1964	530.918	139.966	3.1583	60	1404	345	449.5	510	600	690	769	862	940	
Day Of Week	Weekday	6303	511.13	131.826	1.6605	30	1430	330	420	495	570	670	745	840	920	
Day Of Week	Weekend	3059	557.517	134.392	2.4299	30	1420	360	480	540	630	720	780	870	925	
Season	Winter	2514	534.911	134.719	2.6869	55	1404	355	450	520	600	700	780	870	930	
Season	Spring	2431	526.839	130.49	2.6466	30	1175	345	445	510	600	690	750	840	900	
Season	Summer	2533	527.653	139.46	2.771	30	1430	330	435	510	600	699	765	840	930	
Season	Fall	1884	512.228	131.14	3.0213	60	1420	330	430	505	570	660	735	840	900	
Asthma	No	8608	525.05	133.571	1.4397	30	1430	345	445	510	600	690	750	840	915	
Asthma	Yes	692	540.061	143.571	5.4577	30	1404	330	450	537.5	617.5	715	780	900	945	
Asthma	DK	62	544.194	140.992	17.906	300	1035	330	465	535	600	720	780	930	1035	
Angina	No	9039	526.754	134.235	1.4119	30	1420	345	445	510	600	690	760	855	925	
Angina	Yes	249	513.743	137.698	8.7263	60	1430	300	445	510	595	660	735	795	845	
Angina	DK	74	511.392	146.297	17.0067	30	930	300	420	510	600	720	780	840	930	
Bronchitis/Emphysema	No	8860	526.549	134.267	1.4264	30	1430	345	445	510	600	690	760	850	924	
Bronchitis/Emphysema	Yes	432	521.713	138.459	6.6616	80	1110	300	420	510	600	705	765	840	930	
Bronchitis/Emphysema	DK	70	521.243	131.857	15.7599	210	930	300	450	510	600	690	745	840	930	

Note: A "\*" Signifies missing data. "DK" = The respondent replied "don't know". Refused = Refused data. N = doer sample size. Mean = Mean 24-hour cumulative number of minutes for doers. Stdev = standard deviation. Stderr = standard error. Min = minimum number of minutes. Max = maximum number of minutes. Percentiles are the percentage of doers below or equal to a given number of minutes.  
 Source: Tsang and Klepeis, 1996.



Table 15-84. Statistics for 24-Hour Cumulative Number of Minutes Spent Attending Full Time School

Category	Population Group	N	Mean	Stdev	Stderr	Min	Max	Percentiles							
								5	25	50	75	90	95	98	99
All		884	358.537	130.347	4.384	1	840	95	300	390	435	483	550	600	640
Gender	Male	468	369.301	123.186	5.6943	20	840	120	320	390	435	485	555	595	645
Gender	Female	416	346.428	137.1	6.7219	1	710	75	262.5	385	430	480	535	600	628
Age (years)	*	7	232.143	148.123	55.9853	10	495	10	180	210	320	495	495	495	495
Age (years)	1-4	56	365.036	199.152	26.6128	20	710	30	172.5	427.5	530	595	628	665	710
Age (years)	5-11	297	387.811	98.013	5.6873	60	645	170	360	390	435	485	555	600	630
Age (years)	12-17	271	392.28	84.986	5.1625	10	605	200	375	405	435	460	485	510	555
Age (years)	18-64	247	292.194	154.58	9.8357	1	840	60	180	289	400	480	535	645	785
Age (years)	> 64	6	203.333	147.366	60.1618	75	480	75	120	152.5	240	480	480	480	480
Race	White	665	362.913	128.548	4.9849	1	825	107	310	392	435	485	550	600	630
Race	Black	92	351.793	129.647	13.5166	40	710	70	286.5	387.5	432.5	465	526	645	710
Race	Asian	33	346.303	156.009	24.1576	90	840	120	225	365	435	500	565	840	840
Race	Some Others	29	337.828	148.115	27.5043	58	553	70	212	360	445	502	540	553	553
Race	Hispanic	58	345.259	124.048	16.2883	30	565	85	260	377.5	430	480	510	510	565
Race	Refused	7	285	157.03	59.3517	60	440	60	150	290	440	440	440	440	440
Hispanic	No	771	359.565	130.825	4.7116	1	840	100	300	390	435	483	550	600	645
Hispanic	Yes	103	353.107	126.354	12.4501	30	630	85	269	385	425	483	510	595	600
Hispanic	DK	4	315.5	167.773	83.8863	65	416	65	221	391	410	415	415	415	415
Hispanic	Refused	6	348.333	140.594	57.3973	150	445	150	185	435	440	445	445	445	445
Employment	*	608	386.497	107.308	4.3519	10	710	165	361	400	440	485	550	595	625
Employment	Full Time	49	206.551	133.583	19.0833	5	502	15	115	180	305	430	461	502	502
Employment	Part Time	89	304.652	134.791	14.2879	25	695	90	210	295	395	480	500	585	695
Employment	Not Employed	135	325.274	161.049	13.8609	1	840	60	215	340	420	500	605	785	825
Employment	Refused	3	270	147.224	85	185	440	185	185	440	440	440	440	440	440
Education	*	666	384.985	107.925	4.182	10	710	160	360	400	440	485	550	595	625
Education	< High School	14	267.071	129.31	34.5595	5	415	5	175	310	357	385	415	415	415
Education	High School Graduate	54	238.481	141.148	19.2079	58	785	60	125	212	330	400	480	480	785
Education	< College	100	303.35	170.598	17.0598	1	840	60	185	272.5	415	525.5	613.5	760	832.5
Education	College Graduate	24	238.417	145.897	29.781	25	565	30	135	200	360	430	460	565	565
Education	Post Graduate	26	302.808	144.149	28.2699	10	535	95	210	300	461	500	502	535	535
Census Region	Northeast	186	351.597	127.019	9.3135	60	825	120	268	375	420	483	520	600	785
Census Region	Midwest	200	358.07	123.934	8.7634	5	645	87.5	307.5	392.5	425	470	527.5	577.5	602
Census Region	South	322	373.879	139.7	7.7852	10	840	60	330	405	450	500	565	625	645
Census Region	West	176	338.335	120.469	9.0807	1	630	120	262.5	375	410	465	540	555	600
Day Of Week	Weekday	858	363.66	126.018	4.3022	1	840	120	310	390	435	485	550	600	640
Day Of Week	Weekend	26	189.5	158.415	31.0677	15	465	20	60	120	300	460	465	465	465
Season	Winter	302	375.113	118.518	6.8199	5	695	150	330	395	440	495	550	612	640
Season	Spring	287	353.359	133.705	7.8924	10	840	90	290	390	430	475	500	570	710
Season	Summer	125	332.448	142.088	12.7088	40	630	70	217	375	425	470	550	600	600
Season	Fall	170	357.018	132.833	10.1878	1	785	120	285	380	430	510	565	605	645
Asthma	No	784	357.969	130.658	4.6663	1	840	95	295	390	435	485	550	595	630
Asthma	Yes	96	362.958	127.895	13.0533	20	695	95	334	390	427.5	475	540	645	695
Asthma	DK	4	363.75	162.551	81.2756	120	450	120	280	442.5	447.5	450	450	450	450
Angina	No	875	358.57	130.546	4.4133	1	840	95	300	390	435	483	550	600	640
Angina	Yes	4	382.5	87.702	43.8511	255	455	255	330	410	435	455	455	455	455
Angina	DK	5	333.6	140.481	62.8248	120	460	120	270	378	440	460	460	460	460
Bronchitis/Emphysema	No	851	359.132	130.435	4.4713	1	840	95	300	390	435	485	550	600	640
Bronchitis/Emphysema	Yes	27	340.111	132.683	25.5349	30	605	60	305	365	435	450	460	605	605
Bronchitis/Emphysema	DK	6	357.167	121.491	49.5987	120	440	120	350	396.5	440	440	440	440	440

Note: A "\*" Signifies missing data. "DK" = The respondent replied "don't know". Refused = Refused data. N = doer sample size. Mean = Mean 24-hour cumulative number of minutes for doers. Stdev = standard deviation. Stderr = standard error. Min = minimum number of minutes. Max = maximum number of minutes. Percentiles are the percentage of doers below or equal to a given number of minutes.  
Source: Tsang and Klepeis, 1996.



Table 15-85. Statistics for 24-Hour Cumulative Number of Minutes Spent in Active Sports

Category	Population Group	N	Mean	Stdev	Stderr	Min	Max	Percentiles							
								5	25	50	75	90	95	98	99
All		1384	123.994	112.825	3.0328	1	1130	15	50	90	165	267	330	435	525
Gender	Male	753	136.781	120.777	4.4014	1	1130	20	60	105	180	285	375	500	558
Gender	Female	629	108.628	100.648	4.0131	1	1065	15	38	75	150	240	300	370	435
Gender	Refused	2	142.5	38.891	27.5	115	170	115	115	142.5	170	170	170	170	170
Age (years)	*	23	108.696	78.628	16.395	5	290	30	40	90	155	220	225	290	290
Age (years)	1-4	105	115.848	98.855	9.6472	10	630	30	45	90	159	250	330	345	390
Age (years)	5-11	247	148.87	126.627	8.0571	2	975	20	60	120	188	320	390	510	558
Age (years)	12-17	215	137.46	124.516	8.4919	5	1065	15	60	110	180	265	375	470	520
Age (years)	18-64	642	120.315	110.376	4.3562	1	1130	15	45	90	160	250	330	450	525
Age (years)	> 64	152	88.007	80.207	6.5056	1	380	15	30	60	120	220	285	315	330
Race	White	1139	125.994	116.168	3.4421	1	1130	15	50	90	165	270	340	452	530
Race	Black	109	113.431	96.788	9.2706	5	440	10	45	86	150	240	332	430	435
Race	Asian	30	89.933	79.214	14.4625	5	310	10	30	60	145	215	235	310	310
Race	Some Others	35	135.371	112.206	18.9663	15	553	20	60	105	195	270	330	553	553
Race	Hispanic	59	116.288	91.326	11.8897	1	520	15	45	115	145	240	305	345	520
Race	Refused	12	120	86.576	24.9924	40	300	40	60	95	130	290	300	300	300
Hispanic	No	1250	124.471	113.469	3.2094	1	1130	15	45	90	165	270	330	435	515
Hispanic	Yes	120	121.2	110.791	10.1138	1	630	15	50	90	147.5	240	335	520	553
Hispanic	DK	4	113.75	57.5	28.75	60	185	60	67.5	105	160	185	185	185	185
Hispanic	Refused	10	102	72.119	22.8059	40	290	40	60	82.5	105	215	290	290	290
Employment	*	561	137.073	120.838	5.1018	2	1065	20	60	110	180	285	370	452	558
Employment	Full Time	375	117.579	107.304	5.5412	5	1130	20	45	90	155	240	305	380	525
Employment	Part Time	87	116.207	87.553	9.3867	1	450	15	60	95	160	235	285	355	450
Employment	Not Employed	352	112.537	109.99	5.8625	1	600	10	30	70	150	270	330	475	520
Employment	Refused	9	99.444	77.235	25.7451	30	280	30	45	90	120	280	280	280	280
Education	*	610	137.702	121.227	4.9083	2	1065	20	60	110	180	285	370	470	558
Education	< High School	86	101.047	99.745	10.7558	10	570	15	30	60	135	225	270	510	570
Education	High School Graduate	233	116.794	116.802	7.652	1	1130	20	45	85	150	240	300	420	530
Education	< College	178	115.781	100.276	7.516	1	525	15	45	90	160	270	340	418	475
Education	College Graduate	165	116.218	97.925	7.6235	1	600	15	50	90	150	250	310	380	450
Education	Post Graduate	112	106.446	97.879	9.2487	5	375	10	40	60	142.5	270	330	360	375
Census Region	Northeast	333	131.967	129.1	7.0746	1	1130	15	60	100	170	275	345	485	558
Census Region	Midwest	254	116.882	101.859	6.3912	5	570	18	45	90	150	255	315	430	440
Census Region	South	479	119.476	108.664	4.965	1	975	15	45	90	160	265	330	410	462
Census Region	West	318	128.132	108.811	6.1018	1	625	25	55	92.5	175	295	330	500	525
Day Of Week	Weekday	902	115.47	97.84	3.2577	1	650	15	45	90	150	240	300	395	485
Day Of Week	Weekend	482	139.946	135.196	6.158	1	1130	20	59	100	180	300	380	500	565
Season	Winter	316	115.589	115.201	6.4806	1	1065	15	45	85	155	240	305	370	475
Season	Spring	423	130.775	105.017	5.1061	5	650	30	60	105	175	270	330	435	515
Season	Summer	425	129.541	115.123	5.5843	1	625	15	45	95	178	290	375	462	530
Season	Fall	220	112.314	118.325	7.9775	1	1130	15	43	77.5	143.5	240	290	460	565
Asthma	No	1266	122.461	109.594	3.0801	1	1130	15	45	90	162	266	330	430	515
Asthma	Yes	105	144.829	145.828	14.2314	1	1065	15	60	110	180	300	390	553	565
Asthma	DK	13	105	110.416	30.6239	30	450	30	60	60	90	165	450	450	450
Angina	No	1343	125.491	113.589	3.0995	1	1130	15	50	90	165	270	332	440	525
Angina	Yes	33	72.091	73.998	12.8815	5	330	5	30	50	60	180	275	330	330
Angina	DK	8	86.875	41.139	14.5448	40	155	40	60	75	115	155	155	155	155
Bronchitis/Emphysema	No	1331	124.101	113.19	3.1026	1	1130	15	50	90	165	267	330	435	520
Bronchitis/Emphysema	Yes	43	130	112.663	17.181	10	553	30	45	110	165	270	340	553	553
Bronchitis/Emphysema	DK	10	84	39.847	12.6007	40	155	40	60	75	105	147.5	155	155	155

Note: A "\*" Signifies missing data. "DK" = The respondent replied "don't know". Refused = Refused data. N = doer sample size. Mean = Mean 24-hour cumulative number of minutes for doers. Stdev = standard deviation. Stderr = standard error. Min = minimum number of minutes. Max = maximum number of minutes. Percentiles are the percentage of doers below or equal to a given number of minutes.  
Source: Tsang and Klepeis, 1996.



Table 15-86. Statistics for 24-Hour Cumulative Number of Minutes Spent in Outdoor Recreation

Category	Population Group	N	Mean	Stdev	Stderr	Min	Max	Percentiles							
								5	25	50	75	90	95	98	99
All		253	211.23	185.48	11.661	5	1440	20	60	165	300	480	574	670	690
Gender	Male	140	231.78	207.41	17.529	5	1440	17.5	67.5	177	330	502.5	600	690	735
Gender	Female	112	183.67	150.15	14.188	5	645	20	60	150	255	380	525	585	630
Gender	Refused	1	420	*	*	420	420	420	420	420	420	420	420	420	420
Age (years)	*	2	337.5	201.53	142.5	195	480	195	195	337.5	480	480	480	480	480
Age (years)	1-4	13	166.54	177.06	49.109	15	630	15	30	130	180	370	630	630	630
Age (years)	5-11	21	206.14	156.17	34.078	30	585	60	90	165	245	360	574	585	585
Age (years)	12-17	27	155.07	128.28	24.687	5	465	5	60	135	225	420	420	465	465
Age (years)	18-64	158	223.61	192.97	15.352	5	1440	30	80	172.5	310	505	585	690	690
Age (years)	> 64	32	211.06	206.59	36.521	5	735	5	30	171	375	495	600	735	735
Race	White	225	209.77	182.74	12.183	5	1440	20	60	165	300	460	570	670	690
Race	Black	16	233.88	231.3	57.825	5	690	5	42.5	150	450	585	690	690	690
Race	Asian	3	203.33	262.22	151.39	30	505	30	30	75	505	505	505	505	505
Race	Some Others	2	327.5	130.82	92.5	235	420	235	235	327.5	420	420	420	420	420
Race	Hispanic	4	77.5	53.929	26.964	20	150	20	42.5	70	112.5	150	150	150	150
Race	Refused	3	308.33	209.42	120.91	180	550	180	180	195	550	550	550	550	550
Hispanic	No	238	211.8	187.07	12.126	5	1440	20	60	165	300	480	585	690	690
Hispanic	Yes	12	175.5	149.06	43.029	15	511	15	70	150	255	340	511	511	511
Hispanic	Refused	3	308.33	209.42	120.91	180	550	180	180	195	550	550	550	550	550
Employment	*	60	177.1	150.02	19.368	5	630	12.5	60	147.5	230	395	519.5	585	630
Employment	Full Time	104	210.74	153.37	15.039	5	670	30	82.5	180	294	419	511	600	645
Employment	Part Time	19	205.26	204.04	46.81	30	690	30	60	150	180	570	690	690	690
Employment	Not Employed	68	244.44	245.03	29.715	5	1440	15	60	179.5	375	525	690	735	1440
Employment	Refused	2	187.5	10.607	7.5	180	195	180	180	187.5	195	195	195	195	195
Education	*	64	176.73	145.32	18.165	5	630	15	60	152.5	225	370	465	585	630
Education	< High School	22	259.41	177.97	37.943	5	600	30	105	247.5	380	525	600	600	600
Education	High School Graduate	59	238.2	228.99	29.812	15	1440	20	90	175	310	511	670	690	1440
Education	< College	54	218.09	172.21	23.434	5	690	25	65	172.5	345	460	550	570	690
Education	College Graduate	31	224.71	193.06	34.675	20	690	30	60	150	325	505	645	690	690
Education	Post Graduate	23	157.61	178.18	37.153	5	735	10	50	80	200	370	480	735	735
Census Region	Northeast	52	189.6	160.88	22.31	5	690	30	60	162.5	231.5	370	574	670	690
Census Region	Midwest	54	212.09	228.41	31.083	5	1440	20	60	177.5	280	419	600	735	1440
Census Region	South	84	217.26	175.27	19.123	5	645	15	62.5	150	347.5	495	525	600	645
Census Region	West	63	220.29	179.71	22.642	10	690	30	75	165	280	545	585	690	690
Day Of Week	Weekday	129	197.21	195.32	17.197	5	1440	15	60	150	275	465	525	670	735
Day Of Week	Weekend	124	225.81	174.26	15.649	5	690	20	85	180	310	480	600	690	690
Season	Winter	31	196.61	165.52	29.728	5	585	5	60	165	280	440	550	585	585
Season	Spring	75	198.85	161.67	18.668	5	690	25	75	180	270	465	545	670	690
Season	Summer	102	228.16	204.18	20.217	5	1440	30	75	179.5	325	459	585	690	690
Season	Fall	45	203.53	193.83	28.895	5	735	20	60	120	330	505	574	735	735
Asthma	No	232	208.24	187.69	12.323	5	1440	20	60	159	294	480	585	690	690
Asthma	Yes	19	250.21	166.64	38.23	15	570	15	80	255	350	525	570	570	570
Asthma	DK	2	187.5	10.607	7.5	180	195	180	180	187.5	195	195	195	195	195
Angina	No	245	206.82	184.85	11.81	5	1440	20	60	160	288	480	570	670	690
Angina	Yes	6	399.17	151.21	61.731	285	690	285	310	345	420	690	690	690	690
Angina	DK	2	187.5	10.607	7.5	180	195	180	180	187.5	195	195	195	195	195
Bronchitis/Emphysema	No	238	212.24	189.23	12.266	5	1440	20	60	165	300	495	585	690	690
Bronchitis/Emphysema	Yes	13	196.31	122.22	33.896	5	370	5	117	160	310	340	370	370	370
Bronchitis/Emphysema	DK	2	187.5	10.607	7.5	180	195	180	180	187.5	195	195	195	195	195

Note: A "\*" Signifies missing data. "DK" = The respondent replied "don't know". Refused = Refused data. N = doer sample size. Mean = Mean 24-hour cumulative number of minutes for doers. Stdev = standard deviation. Stderr = standard error. Min = minimum number of minutes. Max = maximum number of minutes. Percentiles are the percentage of doers below or equal to a given number of minutes.  
Source: Tsang and Klepeis, 1996.





Table 15-87. Statistics for 24-Hour Cumulative Number of Minutes Spent in Exercise

Category	Population Group	N	Mean	Stdev	Stderr	Min	Max	Percentiles							
								5	25	50	75	90	95	98	99
All		564	77.429	70.438	2.966	4	670	15	30	60	100	150	195	275	420
Gender	Male	262	84.676	75.778	4.6816	5	670	20	30	60	117	165	205	285	450
Gender	Female	302	71.142	64.927	3.7361	4	525	15	30	60	90	125	175	265	360
Age (years)	*	10	76.5	74.014	23.405	15	270	15	30	60	90	187.5	270	270	270
Age (years)	1-4	11	127.273	187.18	56.437	15	670	15	30	60	150	160	670	670	670
Age (years)	5-11	26	132.5	126.31	24.772	15	525	25	60	90	180	275	450	525	525
Age (years)	12-17	35	67.829	41.589	7.0298	15	180	20	30	60	100	120	150	180	180
Age (years)	18-64	407	77.572	63.597	3.1524	4	480	20	30	60	100	145	185	265	300
Age (years)	> 64	75	54.853	44.455	5.1332	6	195	10	25	40	70	120	150	193	195
Race	White	480	78.015	71.517	3.2643	4	670	15	30	60	100	150	194	285	450
Race	Black	34	74.706	44.67	7.6608	15	250	15	45	60	105	120	130	250	250
Race	Asian	10	46.3	25.038	7.9177	15	95	15	30	41.5	60	82.5	95	95	95
Race	Some Others	14	80.214	73.944	19.762	30	275	30	30	47.5	90	179	275	275	275
Race	Hispanic	19	63	60.658	13.916	15	265	15	30	45	60	160	265	265	265
Race	Refused	7	128.571	130.47	49.313	30	360	30	55	60	270	360	360	360	360
Hispanic	No	516	76.872	70.111	3.0865	4	670	15	30	60	99	145	193	275	420
Hispanic	Yes	38	76.553	59.516	9.6548	15	265	20	30	60	110	160	250	265	265
Hispanic	DK	3	65	69.462	40.104	20	145	20	20	30	145	145	145	145	145
Hispanic	Refused	7	128.571	130.47	49.313	30	360	30	55	60	270	360	360	360	360
Employment	*	72	99.014	111.6	13.153	15	670	20	30	60	120	180	275	525	670
Employment	Full Time	300	72.663	55.618	3.2111	5	460	20	30	60	90	130	179.5	240	291
Employment	Part Time	50	85.98	83.568	11.818	10	420	20	30	60	92	167.5	300	390	420
Employment	Not Employed	139	72.683	63.36	5.3742	4	480	10	30	60	90	135	195	240	265
Employment	Refused	3	113.333	135.77	78.387	30	270	30	30	40	270	270	270	270	270
Education	*	83	101.976	110.97	12.18	15	670	25	30	60	120	205	275	525	670
Education	< High School	21	58.238	66.062	14.416	10	300	10	28	30	60	90	165	300	300
Education	High School Graduate	124	81.048	63.037	5.6609	4	298	15	30	60	115	179	205	250	265
Education	< College	104	80.856	70.181	6.8818	15	480	20	30	60	112.5	150	170	240	420
Education	College Graduate	110	73.627	62.548	5.9637	5	460	20	30	60	98	130	180	285	297
Education	Post Graduate	122	60.861	38.368	3.4737	5	240	15	30	60	80	110	127	165	185
Census Region	Northeast	130	88.423	77.649	6.8102	10	450	15	30	60	120	200	240	297	420
Census Region	Midwest	101	63.564	44.33	4.411	10	300	15	30	60	89	115	120	170	215
Census Region	South	177	75.311	71.62	5.3833	5	525	15	30	60	90	150	185	298	480
Census Region	West	156	79.647	75.331	6.0313	4	670	20	30	60	104	130	183	270	460
Day Of Week	Weekday	426	73.096	63.872	3.0946	4	670	15	30	60	90	130	180	240	298
Day Of Week	Weekend	138	90.804	86.574	7.3697	6	525	15	30	60	120	200	265	420	460
Season	Winter	150	67.387	49.859	4.071	8	285	15	30	60	90	127.5	175	212.5	240
Season	Spring	140	74.871	55.395	4.6817	10	360	17.5	30	60	90	147.5	181	220	298
Season	Summer	192	93.188	91.294	6.5886	5	670	20	30	62.5	120	180	250	450	525
Season	Fall	82	63.268	63.277	6.9878	4	460	15	30	45	75	120	135	300	460
Asthma	No	523	76.625	70.247	3.0717	4	670	15	30	60	100	150	185	265	420
Asthma	Yes	37	78.243	51.454	8.459	20	275	20	45	65	100	120	200	275	275
Asthma	DK	4	175	167.03	83.517	10	360	10	35	165	315	360	360	360	360
Angina	No	553	77.259	69.366	2.9497	4	670	15	30	60	100	145	193	265	420
Angina	Yes	7	27.286	19.576	7.3992	6	60	6	10	25	45	60	60	60	60
Angina	DK	4	188.75	150.35	75.177	60	360	60	62.5	167.5	315	360	360	360	360
Bronchitis/Emphysema	No	542	77.098	69.465	2.9838	4	670	15	30	60	100	145	185	265	420
Bronchitis/Emphysema	Yes	17	64.588	60.635	14.706	10	275	10	30	50	63	120	275	275	275
Bronchitis/Emphysema	DK	5	157	149.57	66.888	15	360	15	60	80	270	360	360	360	360

Note: A "\*" Signifies missing data. "DK" = The respondent replied "don't know". Refused = Refused data. N = doer sample size. Mean = Mean 24-hour cumulative number of minutes for doers. Stdev = standard deviation. Stderr = standard error. Min = minimum number of minutes. Max = maximum number of minutes. Percentiles are the percentage of doers below or equal to a given number of minutes. Source: Tsang and Klepeis, 1996.



Table 15-88. Statistics for 24-Hour Cumulative Number of Minutes Spent in Food Preparation<sup>a</sup>

Category	Population Group	N	Mean	Stdev	Stderr	Min	Max	Percentiles								
								5	25	50	75	90	95	98	99	
All		4278	52.37	52.8802	0.8085	1	555	5	20	35	65	115	150	210	265	
Gender	Male	1341	37.8106	42.1779	1.1518	1	480	5	13	30	50	80	105	150	210	
Gender	Female	2937	59.0177	55.862	1.0308	1	555	5	25	45	75	120	155	224	272	
Age (years)	*	94	52	43.2171	4.4575	5	215	5	20	40	60	110	150	195	215	
Age (years)	1-4	24	56.4583	60.3699	12.3229	5	240	5	22.5	30	75	150	180	240	240	
Age (years)	5-11	60	25.1667	29.6877	3.8327	1	120	2	5	11	30	60	107	120	120	
Age (years)	12-17	131	21.7023	37.6902	3.293	1	385	2	5	10	30	55	70	90	90	
Age (years)	18-64	3173	52.0905	52.8766	0.9387	1	555	5	20	35	65	110	145	210	265	
Age (years)	> 64	796	60.5025	54.669	1.9377	1	525	5	25	45	80	120	150	240	270	
Race	White	3584	51.6205	53.2589	0.8896	1	555	5	19	35	65	110	145	210	265	
Race	Black	377	57.0265	52.2893	2.693	1	390	5	20	40	75	120	150	210	240	
Race	Asian	62	54	41.8224	5.3115	2	210	5	20	50	70	105	130	175	210	
Race	Some Others	66	50.5909	53.2368	6.553	1	295	5	15	33.5	70	115	150	210	295	
Race	Hispanic	132	59.2121	49.7947	4.3341	2	315	5	23.5	55	80	110	135	225	285	
Race	Refused	57	53.1404	49.297	6.5295	2	210	5	20	40	60	120	180	195	210	
Hispanic	No	3960	51.848	52.6035	0.8359	1	555	5	20	35	65	111	145	205	255	
Hispanic	Yes	254	59.2244	56.7225	3.5591	2	420	5	20	45	75	120	155	240	315	
Hispanic	DK	20	54.95	53.2002	11.8959	6	240	8	25	45	60	112.5	180	240	240	
Hispanic	Refused	44	58.6136	53.2957	8.0346	2	210	5	27.5	37.5	80	150	180	210	210	
Employment	*	210	27.1667	40.5487	2.7981	1	385	2	5	15	30	60	90	120	180	
Employment	Full Time	1988	45.4874	46.6734	1.0468	1	480	5	15	30	60	90	130	180	240	
Employment	Part Time	420	53.8643	55.3474	2.7007	2	520	5	20	40	65	105	125	205	255	
Employment	Not Employed	1625	63.6357	57.7587	1.4328	1	555	5	29	45	90	125	170	240	275	
Employment	Refused	35	53.5429	66.7803	11.2879	2	340	2	20	30	60	120	195	340	340	
Education	*	291	31.7079	42.6211	2.4985	1	385	2	5	15	37	75	120	155	195	
Education	< High School	450	61.2556	53.2321	2.5094	1	555	5	30	45	90	120	150	197	225	
Education	High School Graduate	1449	58.8392	56.6653	1.4886	1	520	5	22	45	75	120	155	240	310	
Education	< College	954	52.0073	52.2377	1.6913	1	525	5	20	34.5	65	110	150	210	245	
Education	College Graduate	659	46.2018	48.0775	1.8728	1	515	5	15	30	60	100	125	180	224	
Education	Post Graduate	475	46.1621	48.7374	2.2362	1	375	5	15	30	60	96	135	200	270	
Census Region	Northeast	952	52.312	53.2054	1.7244	1	480	5	20	40	61	110	140	205	255	
Census Region	Midwest	956	53.2333	51.8139	1.6758	1	520	5	20	35	65	120	150	210	265	
Census Region	South	1453	53.3944	53.4621	1.4025	1	555	5	16	35	70	120	150	195	245	
Census Region	West	917	49.9073	52.7204	1.741	1	515	5	15	31	60	105	135	225	265	
Day Of Week	Weekday	2995	50.0571	49.979	0.9132	1	555	5	19	35	60	105	132	180	240	
Day Of Week	Weekend	1283	57.7693	58.7687	1.6407	1	420	5	20	40	75	130	180	240	300	
Season	Winter	1173	50.6206	48.6464	1.4204	1	480	5	18	35	65	110	135	195	240	
Season	Spring	1038	54.3892	54.484	1.6911	1	525	5	20	38.5	70	120	150	224	265	
Season	Summer	1148	51.3972	54.1854	1.5992	1	555	5	20	35	60	110	137	208	300	
Season	Fall	919	53.5375	54.5349	1.7989	1	520	5	20	37	67	120	155	200	265	
Asthma	No	3948	52.0433	53.1805	0.8464	1	555	5	20	35	65	110	145	210	265	
Asthma	Yes	300	57.1433	49.4425	2.8546	1	272	5	20.5	45	75	120	160	199	240	
Asthma	DK	30	47.6333	44.8119	8.1815	2	195	5	10	32.5	60	117.5	120	195	195	
Angina	No	4091	52.1936	52.9733	0.8282	1	555	5	20	35	65	115	150	210	265	
Angina	Yes	149	56.8054	48.2377	3.9518	1	340	5	25	45	80	120	135	180	210	
Angina	DK	38	53.9737	60.4168	9.8009	2	240	2	10	32.5	60	120	240	240	240	
Bronchitis/Emphysema	No	4024	52.0318	53.0963	0.837	1	555	5	20	35	65	110	145	210	265	
Bronchitis/Emphysema	Yes	216	56.9074	46.6833	3.1764	3	240	5	20	45	85	120	150	198	210	
Bronchitis/Emphysema	DK	38	62.3947	61.7031	10.0096	2	240	2	20	42.5	90	150	240	240	240	

Note: A "\*" Signifies missing data. "DK" = The respondent replied "don't know". Refused = Refused data. N = doer sample size. Mean = Mean 24-hour cumulative number of minutes for doers. Stdev = standard deviation. Stderr = standard error. Min = minimum number of minutes. Max = maximum number of minutes. Percentiles are the percentage of doers below or equal to a given number of minutes.

Source: Tsang and Klepeis, 1996.



Table 15-89. Statistics for 24-Hour Cumulative Number of Minutes Spent Doing Dishes/Laundry<sup>a</sup>

Category	Population Group	N	Mean	Stdev	Stderr	Min	Max	Percentiles							
								5	25	50	75	90	95	98	99
All		1865	61.7882	68.894	1.5953	1	825	10	20	30	80	150	190	255	335
Gender	Male	324	46.1142	50.179	2.7877	1	360	10	15	30	60	120	135	210	260
Gender	Female	1541	65.0837	71.793	1.8289	1	825	10	20	35	90	150	200	270	340
Age (years)	*	32	43.75	46.49	8.2183	10	225	10	15	30	55	90	150	225	225
Age (years)	1-4	10	49.3	66.545	21.0434	3	210	3	5	22.5	55	165	210	210	210
Age (years)	5-11	20	34.25	28.799	6.4395	1	92	1.5	15	30	58	82.5	91	92	92
Age (years)	12-17	47	32.6809	30.603	4.4639	2	150	5	10	20	45	65	90	150	150
Age (years)	18-64	1371	63.2356	67.104	1.8123	1	565	10	20	30	90	150	198	245	335
Age (years)	> 64	385	63.4416	79.738	4.0638	1	825	9	20	35	80	135	195	285	375
Race	White	1560	62.2173	69.493	1.7595	1	825	10	20	30	85	147.5	190	270	335
Race	Black	170	57.8471	60.026	4.6038	5	390	5	17	30	75	150	180	235	240
Race	Asian	19	56.7368	51.705	11.862	3	210	3	15	30	90	120	210	210	210
Race	Some Others	25	45.96	41.361	8.2721	5	150	10	15	30	80	120	120	150	150
Race	Hispanic	71	69.0141	75.626	8.9752	3	325	5	20	35	105	200	225	275	325
Race	Refused	20	60.75	104.217	23.3037	5	475	7.5	15	30	60	127.5	305	475	475
Hispanic	No	1732	61.3077	68.206	1.6389	1	825	10	20	30	80	140	180	250	335
Hispanic	Yes	112	68.2589	71.468	6.7531	3	325	5	20	30	103	180	225	270	275
Hispanic	DK	7	75.7143	66.548	25.1526	10	180	10	15	55	150	180	180	180	180
Hispanic	Refused	14	62.5	122.266	32.677	5	475	5	15	25	35	120	475	475	475
Employment	*	73	35.3288	37.364	4.3732	1	210	3	15	20	50	80	120	150	210
Employment	Full Time	776	56.9549	63.42	2.2766	2	565	10	20	30	70	125	180	240	335
Employment	Part Time	214	63.7243	64.791	4.429	2	340	10	15	30	90	151	205	240	275
Employment	Not Employed	789	68.5234	76.296	2.7162	1	825	10	25	40	90	158	210	285	375
Employment	Refused	13	58.2308	59.448	16.4878	10	180	10	10	30	100	150	180	180	180
Education	*	99	37.5253	38.655	3.885	1	210	3	10	30	55	90	120	180	210
Education	< High School	216	69.7824	69.956	4.7599	2	570	10	26.5	45	90	151	195	245	315
Education	High School Graduate	683	67.3616	76.746	2.9366	1	825	10	20	40	90	150	205	285	405
Education	< College	422	64.3033	72.277	3.5184	2	475	10	20	30	85	155	210	285	360
Education	College Graduate	262	51.4466	49.386	3.0511	1	260	10	15	30	70	120	158	200	225
Education	Post Graduate	183	53.6831	60.208	4.4507	3	360	5	15	30	60	120	190	245	330
Census Region	Northeast	471	59.5223	60.067	2.7677	2	565	10	20	35	75	135	180	210	285
Census Region	Midwest	405	60.3235	68.244	3.3911	1	480	5	15	30	75	150	198	240	285
Census Region	South	602	65.8156	75.076	3.0599	1	825	10	20	35	90	150	210	270	360
Census Region	West	387	59.814	69.562	3.536	2	570	10	15	30	70	150	210	270	345
Day Of Week	Weekday	1270	59.5402	68.798	1.9305	1	825	9	20	30	75	137.5	190	245	330
Day Of Week	Weekend	595	66.5866	68.909	2.825	5	565	10	20	40	90	150	210	275	340
Season	Winter	503	65.3479	79.461	3.543	1	825	10	20	30	90	150	210	300	360
Season	Spring	438	62.7763	67.751	3.2373	2	450	10	20	35	75	150	190	285	335
Season	Summer	510	61.7294	62.801	2.7809	2	565	10	20	40	90	140	180	240	270
Season	Fall	414	56.4903	63.125	3.1024	1	570	8	15	30	65	130	195	230	270
Asthma	No	1712	61.9533	69.64	1.6831	1	825	10	20	30	85	150	195	270	335
Asthma	Yes	147	60.8912	60.62	4.9999	2	375	10	20	30	76	151	180	250	255
Asthma	DK	6	36.6667	41.793	17.062	10	120	10	10	25	30	120	120	120	120
Angina	No	1790	62.0788	69.212	1.6359	1	825	10	20	30	85	150	190	255	335
Angina	Yes	66	54.7576	62.985	7.7529	5	335	9	25	30	60	120	200	315	335
Angina	DK	9	55.5556	44.19	14.7301	10	120	10	30	30	90	120	120	120	120
Bronchitis/Emphysema	No	1746	60.5063	65.326	1.5634	1	565	10	20	30	80	140	190	250	325
Bronchitis/Emphysema	Yes	112	82.7143	109.505	10.3473	3	825	5	20	57.5	103	170	240	360	570
Bronchitis/Emphysema	DK	7	46.7143	51.403	19.4284	2	120	2	10	30	120	120	120	120	120

Note: A "\*" Signifies missing data. "DK" = The respondent replied "don't know". Refused = Refused data. N = doer sample size. Mean = Mean 24-hour cumulative number of minutes for doers. Stdev = standard deviation. Stderr = standard error. Min = minimum number of minutes. Max = maximum number of minutes. Percentiles are the percentage of doers below or equal to a given number of minutes.

<sup>a</sup> Includes food cleanup, clothes care.  
Source: Tsang and Klepeis, 1996.



Table 15-90. Statistics for 24-Hour Cumulative Number of Minutes Spent in Housekeeping<sup>a</sup>

Category	Population Group	N	Mean	Stdev	Stderr	Min	Max	Percentiles									
								5	25	50	75	90	95	98	99		
All		1943	118.833	113.369	2.5719	1	810	10	40	90	165	270	345	465	540		
Gender	Male	370	109.419	116.541	6.0587	1	810	10	30	60	150	270	360	425	560		
Gender	Female	1573	121.047	112.533	2.8374	1	790	15	45	90	165	270	345	465	540		
Age (years)	*	47	146.043	121.3	17.6935	10	480	10	45	115	240	300	375	480	480		
Age (years)	1-4	11	74.091	69.42	20.9308	10	270	10	40	60	90	90	270	270	270		
Age (years)	5-11	54	42.852	34.096	4.6399	1	180	5	20	30	53	80	120	150	180		
Age (years)	12-17	72	78.111	75.546	8.9031	1	300	5	27.5	60	105	210	240	285	300		
Age (years)	18-64	1316	120.422	113.654	3.133	1	810	15	40	90	165	270	360	465	525		
Age	> 64	443	128.217	118.925	5.6503	3	790	10	55	90	180	270	345	540	570		
Race	White	1649	119.056	112.184	2.7626	1	790	10	40	90	165	265	340	465	540		
Race	Black	137	116.555	109.394	9.3462	1	490	5	30	90	150	300	358	480	484		
Race	Asian	32	98.75	100.467	17.7602	15	425	15	30	60	127.5	265	345	425	425		
Race	Some Others	26	82.423	56.436	11.0681	5	210	15	40	60	115	185	190	210	210		
Race	Hispanic	71	112.648	129.335	15.3492	5	660	8	30	60	135	270	465	518	660		
Race	Refused	28	189.286	176.198	33.2983	10	810	20	52.5	147.5	247.5	420	465	810	810		
Hispanic	No	1771	117.443	110.586	2.6278	1	790	10	40	90	165	265	335	425	525		
Hispanic	Yes	134	121.657	129.578	11.1939	5	660	10	35	85	135	270	470	540	658		
Hispanic	DK	15	146.867	127.912	33.0268	10	510	10	30	120	210	240	510	510	510		
Hispanic	Refused	23	191.087	180.296	37.5944	10	810	20	45	150	255	390	420	810	810		
Employment	*	138	65.565	68.838	5.8599	1	375	5	25	45	80	180	240	285	300		
Employment	Full Time	673	106.579	102.376	3.9463	1	655	10	30	70	145	240	325	413	490		
Employment	Part Time	193	124.72	117.48	8.4564	1	660	15	45	90	180	270	390	480	540		
Employment	Not Employed	925	132.681	119.442	3.9272	3	790	15	55	105	180	295	370	484	600		
Employment	Refused	14	236.786	208.221	55.6495	10	810	10	120	182.5	300	430	810	810	810		
Education	*	171	82.164	96.944	7.4135	1	810	5	30	45	105	220	270	300	375		
Education	< High School	246	140.736	125.356	7.9924	3	715	10	60	120	180	300	400	540	660		
Education	High School Graduate	677	125.078	120.495	4.631	2	790	15	45	90	175	270	375	490	610		
Education	< College	433	112.898	100.145	4.8127	1	570	10	40	90	150	240	320	420	470		
Education	College Graduate	245	107.302	102.244	6.5321	1	585	15	30	60	150	240	328	405	465		
Education	Post Graduate	171	130.813	117.998	9.0236	5	655	15	60	90	180	280	390	495	540		
Census Region	Northeast	464	119.235	116.368	5.4022	2	790	10	35	90	165	245	330	480	655		
Census Region	Midwest	413	117.855	112.595	5.5405	1	715	10	34	88	165	255	345	480	525		
Census Region	South	648	119.912	116.159	4.5631	1	810	10	40	90	165	285	370	435	540		
Census Region	West	418	117.679	106.559	5.212	5	720	15	40	90	165	255	340	420	470		
Day Of Week	Weekday	1316	113.21	111.913	3.085	1	790	10	30	75	150	255	330	470	550		
Day Of Week	Weekend	627	130.635	115.567	4.6153	1	810	15	55	90	180	290	370	435	525		
Season	Winter	470	111.4	100.617	4.6411	1	810	10	45	85	160	240	290	390	480		
Season	Spring	451	122.621	114.024	5.3692	3	720	15	40	90	180	270	360	465	540		
Season	Summer	563	111.803	114.5	4.8256	1	690	10	30	75	135	255	365	465	610		
Season	Fall	459	131.344	122.391	5.7127	1	790	15	45	90	180	300	390	480	560		
Asthma	No	1789	118.529	112.075	2.6497	1	790	10	40	90	165	270	345	465	540		
Asthma	Yes	140	115.664	115.811	9.7878	5	690	10	36.5	67	150	277.5	377.5	470	480		
Asthma	DK	14	189.286	208.565	55.7414	10	810	10	45	122.5	255	340	810	810	810		
Angina	No	1853	117.731	112.346	2.6099	1	790	13	40	90	160	265	345	465	540		
Angina	Yes	75	122.88	103.762	11.9814	5	394	5	30	90	210	270	320	370	394		
Angina	DK	15	234.667	204	52.6725	10	810	10	120	240	300	480	810	810	810		
Bronchitis/Emphysema	No	1816	118.073	112.929	2.65	1	790	10	40	90	160	270	355	465	540		
Bronchitis/Emphysema	Yes	107	118.701	102.942	9.9518	5	480	10	30	90	180	255	290	465	470		
Bronchitis/Emphysema	DK	20	188.5	176.435	39.452	5	810	7.5	85	155	240	320	575	810	810		

Note: A "\*" Signifies missing data. "DK" = The respondent replied "don't know". Refused = Refused data. N = doer sample size. Mean = Mean 24-hour cumulative number of minutes for doers. Stdev = standard deviation. Stderr = standard error. Min = minimum number of minutes. Max = maximum number of minutes. Percentiles are the percentage of doers below or equal to a given number of minutes.

a Includes cleaning house, other repairs, and household work.

Source: Tsang and Klepeis, 1996.



Table 15-91. Statistics for 24-Hour Cumulative Number of Minutes Spent in Bathing (a)

Group Name	Group Code	N	Mean	Stdev	Stderr	Min	Max	Percentiles								
								5	25	50	75	90	95	98	99	
All		6416	26.0842	29.6711	0.3704	1	705	5	10	20	30	50	60	90	120	
Gender	Male	2930	24.2416	31.0251	0.5732	1	705	5	10	20	30	45	60	75	100	
Gender	Female	3484	27.6372	28.4021	0.4812	1	555	5	10	20	30	60	75	105	135	
Gender	Refused	2	20	14.1421	10	10	30	10	10	20	30	30	30	30	30	
Age (years)	*	114	29.0088	38.9855	3.6513	2	300	5	10	20	30	60	60	105	275	
Age (years)	1-4	330	29.9727	19.4226	1.0692	1	170	10	15	30	31	54.5	60	85	90	
Age (years)	5-11	438	25.7511	35.3164	1.6875	1	690	5	15	20	30	45	60	60	75	
Age (years)	12-17	444	23.1216	18.7078	0.8878	1	210	5	10	18	30	45	60	65	90	
Age (years)	18-64	4383	25.4312	27.1553	0.4102	1	555	5	10	20	30	50	60	90	120	
Age (years)	> 64	707	29.9123	44.502	1.6737	1	705	5	10	20	30	60	85	120	150	
Race	White	5117	25.0233	28.5494	0.3991	1	705	5	10	20	30	45	60	90	115	
Race	Black	707	31.4851	31.5524	1.1866	1	295	5	15	22	40	60	80	120	170	
Race	Asian	112	28.1786	29.7661	2.8126	5	270	5	15	20	30	60	75	90	90	
Race	Some Others	122	30.2213	27.2726	2.4691	1	240	8	15	27.5	35	50	60	100	150	
Race	Hispanic	280	28.7786	39.2648	2.3465	2	546	5	15	20	31.5	54.5	62.5	90	155	
Race	Refused	78	27.5769	40.3235	4.5657	3	275	5	10	15	30	60	100	195	275	
Hispanic	No	5835	25.8833	28.5411	0.3736	1	705	5	10	20	30	50	60	90	120	
Hispanic	Yes	486	28.751	40.5582	1.8398	2	570	5	15	20	30	50	60	90	140	
Hispanic	DK	33	25.7576	16.7724	2.9197	5	65	10	15	20	30	55	65	65	65	
Hispanic	Refused	62	24.2581	37.2268	4.7278	3	275	5	10	15	25	30	60	105	275	
Employment	*	1189	26.1329	26.4288	0.7665	1	690	5	15	20	30	45	60	75	90	
Employment	Full Time	3095	24.1499	25.0984	0.4511	1	555	5	10	15	30	45	60	85	110	
Employment	Part Time	558	24.7616	23.2468	0.9841	1	295	5	10	20	30	46	60	90	110	
Employment	Not Employed	1528	30.3161	39.9341	1.0216	1	705	5	10	20	30	60	85	120	155	
Employment	Refused	46	30.4348	45.176	6.6608	3	275	5	10	15	30	55	105	275	275	
Education	*	1330	25.6759	26.4094	0.7242	1	690	5	15	20	30	45	60	75	90	
Education	< High School	474	33.3122	53.0129	2.435	1	570	5	15	20.5	33	60	85	110	300	
Education	High School Graduate	1758	25.822	23.5699	0.5621	1	270	5	10	20	30	50	60	90	120	
Education	< College	1288	26.4099	27.0338	0.7533	1	255	5	10	20	30	55	75	105	150	
Education	College Graduate	897	25.3813	34.8197	1.1626	1	705	5	10	15	30	50	65	105	135	
Education	Post Graduate	669	22.7788	23.0661	0.8918	1	257	5	10	15	30	45	60	85	100	
Census Region	Northeast	1444	25.0478	24.2512	0.6382	1	360	5	10	20	30	50	60	90	105	
Census Region	Midwest	1402	24.602	30.2958	0.8091	1	570	5	10	15	30	45	60	85	115	
Census Region	South	2266	27.4086	26.0895	0.5481	1	300	5	15	20	30	55	65	100	135	
Census Region	West	1304	26.5238	38.8092	1.0747	1	705	5	10	20	30	48	60	90	133	
Day Of Week	Weekday	4427	25.2896	30.2913	0.4553	1	705	5	10	20	30	45	60	90	115	
Day Of Week	Weekend	1989	27.8527	28.1689	0.6316	1	555	5	15	20	30	60	68	100	130	
Season	Winter	1796	26.858	26.9167	0.6351	1	546	5	11	20	30	50	60	90	110	
Season	Spring	1645	28.5854	41.0512	1.0121	1	705	5	15	20	30	60	70	115	150	
Season	Summer	1744	23.9295	20.7343	0.4965	1	270	5	10	19.5	30	45	60	80	100	
Season	Fall	1231	24.6653	25.5885	0.7293	1	340	5	10	17	30	50	60	95	120	
Asthma	No	5912	26.0658	30.0373	0.3907	1	705	5	10	20	30	50	60	90	120	
Asthma	Yes	468	26.5427	22.9543	1.0611	1	210	5	15	20	30	46	60	100	120	
Asthma	DK	36	23.1389	44.0728	7.3455	3	275	5	10	15	25	30	30	275	275	
Angina	No	6243	26.0042	29.0175	0.3673	1	705	5	10	20	30	50	60	90	120	
Angina	Yes	131	31.145	49.5427	4.3286	5	546	5	15	25	30	50	60	105	131	
Angina	DK	42	22.1905	40.9153	6.3134	3	275	5	10	15	25	30	30	275	275	
Bronchitis/Emphysema	No	6112	26.0545	29.857	0.3819	1	705	5	10	20	30	50	60	90	120	
Bronchitis/Emphysema	Yes	268	27.2463	22.162	1.3538	1	150	5	13	20	30	60	60	95	131	
Bronchitis/Emphysema	DK	36	22.4722	44.0859	7.3477	3	275	5	10	15	22.5	30	30	275	275	

Note: A "\*" Signifies missing data. "DK" = The respondent replied "don't know". Refused = Refused data. N = doer sample size. Mean = Mean 24-hour cumulative number of minutes for doers. Stdev = standard deviation. Stderr = standard error. Min = minimum number of minutes. Max = maximum number of minutes. Percentiles are the percentage of doers below or equal to a given number of minutes.

a Includes baby and child care, personal care services, washing and personal hygiene (bathing, showering, etc.)

Source: Tsang and Klepeis, 1996.



Table 15-92. Statistics for 24-Hour Cumulative Number of Minutes Spent in Yardwork/Maintenance (a)

Category	Population Group	N	Mean	Stdev	Stdev	Min	Max	Percentiles								
								5	25	50	75	90	95	98	99	
All		1414	147.69	148.216	3.942	1	1080	5	45	100	205	360	470	570	655	
Gender	Male	804	174.84	160.191	5.649	2	1080	10	60	120	249.5	415	510	600	670	
Gender	Female	610	111.91	121.979	4.939	1	900	5	30	75	145	277.5	360	465	510	
Age (years)	*	20	181.85	170.345	38.09	5	600	10	60	116	240	467.5	570	600	600	
Age (years)	1-4	12	93.167	80.805	23.326	5	285	5	30	82.5	132.5	178	285	285	285	
Age (years)	5-11	26	96.154	85.532	16.774	5	330	5	39	60	120	210	300	330	330	
Age (years)	12-17	54	116	116.758	15.889	3	505	5	30	90	150	285	385	450	505	
Age (years)	18-64	1015	150.22	154.486	4.849	1	1080	5	35	100	210	360	480	585	670	
Age (years)	> 64	287	149.3	133.834	7.9	2	810	10	60	120	205	330	420	525	630	
Race	White	1249	151.52	150.205	4.25	1	1080	5	45	105	210	360	480	575	660	
Race	Black	77	114.53	127.124	14.487	2	750	5	20	65	165	285	355	405	750	
Race	Asian	13	140	150.111	41.633	5	425	5	15	85	210	360	425	425	425	
Race	Some Others	26	117.23	110.647	21.7	5	380	5	30	88	178	290	360	380	380	
Race	Hispanic	37	102.11	113.508	18.661	5	565	5	20	60	120	255	300	565	565	
Race	Refused	12	177.08	190.793	55.077	30	600	30	60	97.5	215	510	600	600	600	
Hispanic	No	1331	148.69	147.962	4.056	1	1080	5	45	105	209	360	465	570	660	
Hispanic	Yes	65	106.17	127.4	15.802	5	575	5	20	60	120	255	300	565	575	
Hispanic	DK	8	248.75	206.48	73.002	5	585	5	90	190	420	585	585	585	585	
Hispanic	Refused	10	203.5	200.056	63.263	60	600	60	60	120	300	555	600	600	600	
Employment	*	92	106.82	101.779	10.611	3	505	5	31.5	77	147.5	240	330	450	505	
Employment	Full Time	664	146.73	155.488	6.034	1	1080	5	35	90	202.5	360	490	575	690	
Employment	Part Time	121	134.51	130.79	11.89	2	554	5	30	90	200	317	390	490	495	
Employment	Not Employed	526	157.76	147.022	6.41	2	810	10	60	120	220	370	480	595	655	
Employment	Refused	11	211.55	198.724	59.918	2	600	2	60	120	375	465	600	600	600	
Education	*	105	113.47	113.854	11.111	2	600	5	33	79	150	285	360	450	505	
Education	< High School	160	158.46	164.764	13.026	2	900	7.5	45	111	210	412.5	492.5	595	810	
Education	High School Graduate	465	151.39	146.985	6.816	3	840	5	50	110	210	345	460	575	690	
Education	< College	305	152.84	157.011	8.99	2	1080	5	45	95	210	360	473	600	630	
Education	College Graduate	211	145.36	138.849	9.559	1	625	5	40	105	225	330	465	525	533	
Education	Post Graduate	168	142.2	147.773	11.401	2	690	5	30	90	180	340	470	570	630	
Census Region	Northeast	291	140.5	139.641	8.186	3	840	5	40	90	200	330	450	525	600	
Census Region	Midwest	314	145.1	143.219	8.082	2	780	10	55	95	195	360	445	560	655	
Census Region	South	438	152.69	156.36	7.471	2	1080	5	45	111	205	375	480	585	635	
Census Region	West	371	149.63	149.345	7.754	1	750	5	40	104	210	350	480	575	690	
Day Of Week	Weekday	878	140.86	140.753	4.75	1	810	5	40	92.5	190	345	460	560	625	
Day Of Week	Weekend	536	158.88	159.193	6.876	2	1080	5	50	116.5	225	380	510	600	690	
Season	Winter	289	139.35	151.711	8.924	1	690	5	30	75	195	360	480	565	600	
Season	Spring	438	162.23	150.477	7.19	3	900	10	60	120	220	360	480	570	700	
Season	Summer	458	137.92	140.291	6.555	2	1080	5	40	90	180	310	440	555	630	
Season	Fall	229	149.97	153.398	10.137	2	720	5	40	97	210	390	480	600	655	
Asthma	No	1311	146.95	147.084	4.062	1	1080	5	45	100	200	355	465	570	635	
Asthma	Yes	98	149.27	155.758	15.734	5	670	5	30	90	210	445	480	670	670	
Asthma	DK	5	312	230.043	102.879	60	600	60	120	300	480	600	600	600	600	
Angina	No	1360	145.34	145.05	3.933	1	900	5	45	100	200	355	465	570	655	
Angina	Yes	42	192.62	203.363	31.38	5	1080	15	60	142.5	255	465	485	1080	1080	
Angina	DK	12	257.08	216.716	62.56	5	600	5	52.5	232.5	472.5	510	600	600	600	
Bronchitis/Emphysema	No	1352	148.48	148.534	4.04	1	1080	5	45	105	205	360	470	570	660	
Bronchitis/Emphysema	Yes	57	114.65	121.376	16.077	5	460	5	30	60	135	340	375	405	460	
Bronchitis/Emphysema	DK	5	312	230.043	102.879	60	600	60	120	300	480	600	600	600	600	

Note: A "\*" Signifies missing data. "DK" = The respondent replied "don't know". Refused = Refused data. N = doer sample size. Mean = Mean 24-hour cumulative number of minutes for doers. Stdev = standard deviation. Stdev = standard error. Min = minimum number of minutes. Max = maximum number of minutes. Percentiles are the percentage of doers below or equal to a given number of minutes.

a Includes car repair services, other repairs services, outdoor cleaning, car repair maintenance, other repairs, plant care, other household work, domestic crafts, domestic arts.

Source: Tsang and Klepeis, 1996.



Table 15-93. Statistics for 24-Hour Cumulative Number of Minutes Spent in Sports/Exercise (a)

Category	Population Group	N	Mean	Stdev	Stderr	Min	Max	Percentiles							
								5	25	50	75	90	95	98	99
All		1852	116.322	107.947	2.5084	1	1130	17	45	85	150	253	316	420	515
Gender	Male	958	130.669	117.216	3.7871	1	1130	20	55	97.5	175	270	355	475	558
Gender	Female	892	100.854	94.795	3.174	1	1065	15	35	65	130	230	285	370	435
Gender	Refused	2	142.5	38.891	27.5	115	170	115	115	143	170	170	170	170	170
Age (years)	*	32	102.031	79.32	14.022	5	290	15	40	80	137.5	225	270	290	290
Age (years)	1-4	114	118.982	109.17	10.2247	10	670	25	45	90	159	250	330	390	630
Age (years)	5-11	262	153.496	130.58	8.0673	2	975	20	60	120	200	330	415	525	580
Age (years)	12-17	237	134.717	122.228	7.9396	5	1065	15	60	110	179	265	360	470	520
Age (years)	18-64	992	109.692	100.801	3.2004	1	1130	20	45	75	145	240	300	405	510
Age (years)	> 64	215	82.051	75.995	5.1828	1	380	10	30	60	110	195	270	310	316
Race	White	1541	117.524	110.622	2.818	1	1130	20	45	85	150	255	320	435	525
Race	Black	135	110.4	93.06	8.0094	5	440	15	45	85	150	220	340	430	435
Race	Asian	37	85.432	73.897	12.1486	5	310	10	30	60	95	210	235	310	310
Race	Some Others	47	124.702	106.397	15.5196	15	553	30	40	85	180	270	325	553	553
Race	Hispanic	74	108.892	89.177	10.3667	1	520	15	45	90	145	225	270	345	520
Race	Refused	18	130	111.698	26.3275	30	420	30	60	82.5	140	300	420	420	420
Hispanic	No	1678	116.451	108.276	2.6432	1	1130	17	45	85	150	253	316	430	510
Hispanic	Yes	151	115.583	106.428	8.661	1	630	15	45	90	145	240	325	415	553
Hispanic	DK	7	92.857	62.773	23.726	20	185	20	30	75	145	185	185	185	185
Hispanic	Refused	16	120	110	27.5	30	420	30	60	70	122.5	290	420	420	420
Employment	*	606	138.658	123.665	5.0235	2	1065	20	60	110	180	285	375	470	580
Employment	Full Time	644	102.315	94.146	3.7099	5	1130	20	45	67.5	130	225	280	360	405
Employment	Part Time	125	115.272	91.33	8.1688	1	450	15	45	90	160	220	300	420	420
Employment	Not Employed	465	107.239	104.105	4.8277	1	600	10	31	70	135	250	310	462	515
Employment	Refused	12	102.917	87.917	25.3794	30	280	30	40	75	130	270	280	280	280
Education	*	663	139.46	123.813	4.8085	2	1065	20	60	110	180	285	383	510	580
Education	< High School	103	96.243	97.046	9.5622	10	570	15	30	60	135	210	270	305	510
Education	High School Graduate	341	109.276	106.483	5.7664	1	1130	15	40	75	150	235	285	405	485
Education	< College	265	110.068	94.836	5.8257	1	525	17	45	80	145	240	305	418	475
Education	College Graduate	258	105.717	92.204	5.7404	1	600	20	45	70	130	240	297	343	450
Education	Post Graduate	222	87.149	79.704	5.3494	5	375	15	30	60	105	208	290	355	360
Census Region	Northeast	437	126.865	122.905	5.8793	1	1130	15	50	95	165	270	338	470	558
Census Region	Midwest	341	105.889	94.38	5.111	5	570	20	40	75	135	240	280	430	438
Census Region	South	627	112.774	104.846	4.1872	1	975	15	45	80	150	250	313	410	462
Census Region	West	447	118.951	105.629	4.9961	4	670	22	48	85	160	250	325	475	525
Day Of Week	Weekday	1264	107.154	94.026	2.6447	1	670	15	45	75	140	235	285	375	485
Day Of Week	Weekend	588	136.029	130.966	5.401	1	1130	20	51.5	90	180	297	380	462	558
Season	Winter	448	104.094	104.108	4.9187	1	1065	15	40	70	130	230	280	360	420
Season	Spring	533	123.452	100.904	4.3706	5	650	25	60	90	162	267	330	420	500
Season	Summer	579	125.988	114.358	4.7525	1	670	15	45	90	160	283	360	470	545
Season	Fall	292	102.901	110.416	6.4616	4	1130	15	40	60	127.5	225	275	460	565
Asthma	No	1699	114.927	105.239	2.5532	1	1130	17	45	85	150	250	310	420	510
Asthma	Yes	137	132.131	134.238	11.4687	1	1065	15	60	90	165	265	390	553	565
Asthma	DK	16	129.063	134.786	33.6966	10	450	10	60	60	152.5	420	450	450	450
Angina	No	1801	117.3	108.373	2.5537	1	1130	20	45	89	150	254	316	430	515
Angina	Yes	40	68	70.942	11.217	5	330	5.5	30	47.5	60	172.5	235	330	330
Angina	DK	11	131.818	116.023	34.9823	40	420	40	60	90	155	270	420	420	420
Bronchitis/Emphysema	No	1782	116.226	107.987	2.5581	1	1130	17	45	85	150	250	315	430	515
Bronchitis/Emphysema	Yes	56	119.429	108.516	14.501	10	553	20	42.5	75	172.5	270	340	410	553
Bronchitis/Emphysema	DK	14	116.071	108.187	28.9143	15	420	15	60	85	140	270	420	420	420

Note: A "\*" Signifies missing data. "DK" = The respondent replied "don't know". Refused = Refused data. N = doer sample size. Mean = Mean 24-hour cumulative number of minutes for doers. Stdev = standard deviation. Stderr = standard error. Min = minimum number of minutes. Max = maximum number of minutes. Percentiles are the percentage of doers below or equal to a given number of minutes.

a Includes active sports, exercise, hobbies.

Source: Tsang and Klepeis, 1996.



Table 15-94. Statistics for 24-Hour Cumulative Number of Minutes Eating or Drinking

Category	Population Group	N	Mean	Stdev	Stderr	Min	Max	Percentiles									
								5	25	50	75	90	95	98	99		
All		8627	74.8821	54.8419	0.5904	1	900	15	35	60	96	140	175	215	270		
Gender	Male	3979	75.8316	56.2313	0.8914	1	900	15	39	60	96	140	180	210	270		
Gender	Female	4644	74.0814	53.6353	0.7871	2	640	15	34	60	98	140	170	225	270		
Gender	Refused	4	60	21.2132	10.6066	30	75	30	45	67.5	75	75	75	75	75		
Age (years)	*	157	75.3248	50.1255	4.0005	10	315	15	30	65	100	145	150	195	285		
Age (years)	1-4	492	93.4837	52.8671	2.3834	2	345	20	60	90	120	160	190	225	270		
Age (years)	5-11	680	68.5412	38.9518	1.4937	5	255	15	40	65	90	120	142.5	165	195		
Age (years)	12-17	538	55.8587	34.9903	1.5085	2	210	10	30	50	75	105	125	150	170		
Age (years)	18-64	5464	71.8673	55.1199	0.7457	1	900	15	30	60	90	135	170	220	270		
Age (years)	> 64	1296	91.7014	62.6665	1.7407	5	750	20	50	80	120	165	200	270	295		
Race	White	7049	77.0058	55.6564	0.6629	1	900	15	40	64	100	145	180	225	270		
Race	Black	808	59.9047	46.5954	1.6392	2	505	15	30	50	75	119	140	200	225		
Race	Asian	148	80.4054	47.8283	3.9315	2	305	15	45	72.5	106.5	150	160	200	200		
Race	Some Others	168	66.0417	52.0928	4.019	7	525	15	30	59.5	83	120	135	190	200		
Race	Hispanic	345	68.7043	51.8926	2.7938	2	435	12	30	60	90	125	165	195	225		
Race	Refused	109	74.2477	60.8473	5.8281	8	410	20	30	60	90	130	180	290	315		
Hispanic	No	7861	75.5599	55.2306	0.6229	1	900	15	35	60	100	140	175	220	270		
Hispanic	Yes	639	68.2754	50.1994	1.9859	2	435	15	30	60	90	120	155	195	225		
Hispanic	DK	41	60.4146	37.1039	5.7947	5	150	15	30	55	90	120	130	150	150		
Hispanic	Refused	86	68.9186	55.4732	5.9818	8	410	15	30	60	90	115	155	210	410		
Employment	*	1695	72.2083	44.9086	1.0908	2	345	15	40	65	90	133	150	195	210		
Employment	Full Time	3684	70.6097	55.0998	0.9078	1	900	15	30	60	90	135	165	225	270		
Employment	Part Time	715	72.2112	55.4476	2.0736	2	509	15	30	60	90	135	170	230	260		
Employment	Not Employed	2472	83.9498	59.1281	1.1892	2	750	15	45	75	110	150	185	235	285		
Employment	Refused	61	71.0492	60.9843	7.8082	8	385	15	30	55	90	120	145	235	385		
Education	*	1867	70.85	45.3955	1.0506	2	375	15	38	60	90	130	150	190	210		
Education	< High School	758	72.3206	57.4352	2.0861	2	460	15	30	60	90	135	180	230	315		
Education	High School Graduate	2363	74.8565	57.1005	1.1746	1	900	15	35	60	96	140	175	220	270		
Education	< College	1612	73.9237	56.5324	1.408	2	525	15	30	60	90	145	175	230	275		
Education	College Graduate	1160	78.4991	55.4196	1.6272	1	640	15	40	65	105	145	180	220	265		
Education	Post Graduate	867	82.8166	59.6871	2.0271	2	750	15	40	70	110	150	185	240	270		
Census Region	Northeast	1916	78.2766	59.1627	1.3516	1	750	15	37	65	102.5	145	180	240	285		
Census Region	Midwest	1928	75.8117	51.3702	1.1699	1	435	15	40	64	100	140	175	210	255		
Census Region	South	2960	71.3916	55.0903	1.0126	2	900	15	30	60	90	135	165	210	270		
Census Region	West	1823	75.9989	52.9755	1.2407	2	500	15	35	60	100	150	180	210	240		
Day Of Week	Weekday	5813	71.2069	52.0446	0.6826	1	900	15	33	60	90	130	165	210	250		
Day Of Week	Weekend	2814	82.4741	59.5052	1.1217	2	630	15	40	70	110	150	190	240	297		
Season	Winter	2332	76.0931	56.4379	1.1687	2	640	15	38.5	65	95.5	140	175	240	275		
Season	Spring	2222	76.3096	55.207	1.1712	1	630	15	35	60	100	145	178	220	275		
Season	Summer	2352	73.4787	53.2506	1.098	1	750	15	35	60	95	135	170	210	260		
Season	Fall	1721	73.3161	54.2737	1.3083	2	900	15	30	60	95	140	175	210	232		
Asthma	No	7937	75.2016	54.8093	0.6152	1	900	15	35	60	100	140	175	215	270		
Asthma	Yes	635	71.3732	55.0353	2.184	2	460	15	30	60	90	133	170	225	285		
Asthma	DK	55	69.2909	56.5874	7.6302	8	335	15	30	60	90	120	210	215	335		
Angina	No	8318	74.5795	54.4372	0.5969	1	900	15	35	60	95	140	175	210	265		
Angina	Yes	243	85.0288	63.5335	4.0757	2	500	15	45	75	115	160	180	285	330		
Angina	DK	66	75.6667	67.304	8.2845	5	435	15	30	60	90	150	195	215	435		
Bronchitis/Emphysema	No	8169	74.6605	54.3234	0.601	1	900	15	35	60	95	140	170	210	260		
Bronchitis/Emphysema	Yes	397	80.6599	65.2442	3.2745	2	460	15	30	60	110	150	180	285	360		
Bronchitis/Emphysema	DK	61	66.9508	47.7188	6.1098	8	230	15	30	60	90	120	155	215	230		

Note: A "\*" Signifies missing data. "DK" = The respondent replied "don't know". Refused = Refused data. N = doer sample size. Mean = Mean 24-hour cumulative number of minutes for doers. Stdev = standard deviation. Stderr = standard error. Min = minimum number of minutes. Max = maximum number of minutes. Percentiles are the percentage of doers below or equal to a given number of minutes.  
Source: Tsang and Klepeis, 1996.





Table 15-95. Statistics for 24-Hour Cumulative Number of Minutes Spent Indoors at an Auto Repair Shop/Gas Station

Category	Population Group	N	Mean	Stdev	Stderr	Min	Max	Percentiles									
								5	25	50	75	90	95	98	99		
All		153	190.693	234.506	18.959	1	930	5	15	60	360	565	645	695	748		
Gender	Male	105	241.476	250.274	24.424	2	930	5	15	115	495	600	675	700	748		
Gender	Female	48	79.604	144.512	20.858	1	595	3	10	15	70	295	485	595	595		
Age (years)	*	3	161.667	115.578	66.729	90	295	90	90	100	295	295	295	295	295		
Age (years)	1-4	4	40	50.166	25.083	10	115	10	12.5	17.5	67.5	115	115	115	115		
Age (years)	5-11	5	22	21.679	9.695	5	60	5	15	15	15	60	60	60	60		
Age (years)	12-17	7	153.857	205.069	77.509	3	505	3	5	55	390	505	505	505	505		
Age (years)	18-64	118	223.847	249.335	22.953	1	930	5	15	75	480	600	675	700	748		
Age (years)	> 64	16	58.125	96.889	24.222	2	358	2	15	20	42.5	225	358	358	358		
Race	White	130	195.538	237.537	20.833	1	930	5	15	60	390	587.5	645	700	748		
Race	Black	12	149.667	203.31	58.691	2	565	2	6.5	75	229	495	565	565	565		
Race	Asian	5	173	231.236	103.412	5	525	5	15	25	295	525	525	525	525		
Race	Some Others	3	15	10	5.774	5	25	5	5	15	25	25	25	25	25		
Race	Hispanic	3	350	330.114	190.591	15	675	15	15	360	675	675	675	675	675		
Hispanic	No	148	188.926	233.749	19.214	1	930	5	15	60	369.5	565	630	700	748		
Hispanic	Yes	5	243	279.701	125.086	15	675	15	15	150	360	675	675	675	675		
Employment	*	16	84.188	146.714	36.678	3	505	3	12.5	17.5	69.5	390	505	505	505		
Employment	Full Time	84	283.571	263.755	28.778	3	930	5	17.5	230	540	630	680	748	930		
Employment	Part Time	16	104.188	147.369	36.842	5	390	5	12.5	17.5	187.5	359	390	390	390		
Employment	Not Employed	35	65.914	94.745	16.015	1	432	2	15	30	90	160	358	432	432		
Employment	Refused	2	17.5	17.678	12.5	5	30	5	5	17.5	30	30	30	30	30		
Education	*	18	95.056	153.879	36.27	3	505	3	10	17.5	79	390	505	505	505		
Education	< High School	16	327.188	301.181	75.295	5	930	5	60	278	615	675	930	930	930		
Education	High School Graduate	51	233.353	243.089	34.039	2	748	5	20	120	480	565	675	695	748		
Education	< College	32	253.469	252.8	44.689	2	700	5	15	157	517.5	595	680	700	700		
Education	College Graduate	19	72.895	126.321	28.98	1	508	1	5	20	90	295	508	508	508		
Education	Post Graduate	17	49	73.388	17.799	5	235	5	10	15	35	225	235	235	235		
Census Region	Northeast	29	247.31	257.069	47.737	2	930	3	30	120	432	600	748	930	930		
Census Region	Midwest	48	230.896	251.622	36.318	1	700	5	17.5	74.5	510	600	680	700	700		
Census Region	South	43	165.721	211.591	32.267	3	675	5	15	50	358	555	595	675	675		
Census Region	West	33	115	198.907	34.625	5	675	5	10	15	100	505	645	675	675		
Day Of Week	Weekday	121	204.645	244.861	22.26	1	930	5	15	60	390	595	675	700	748		
Day Of Week	Weekend	32	137.938	184.175	32.558	2	540	3	15	40	200	505	510	540	540		
Season	Winter	28	177.143	258.088	48.774	2	930	5	15	30	355	595	700	930	930		
Season	Spring	44	189.636	223.267	33.659	2	645	5	15	79.5	384.5	565	600	645	645		
Season	Summer	52	171.692	223.809	31.037	1	680	3	10	30	347.5	540	675	675	680		
Season	Fall	29	239.448	251.391	46.682	5	748	8	35	95	445	605	695	748	748		
Asthma	No	145	191.29	235.288	19.54	1	930	5	15	60	360	565	645	700	748		
Asthma	Yes	8	179.875	234.838	83.028	5	600	5	5	37.5	374.5	600	600	600	600		
Angina	No	149	191.047	235.262	19.273	1	930	5	15	60	360	585	645	700	748		
Angina	Yes	4	177.5	235.744	117.872	5	510	5	10	97.5	345	510	510	510	510		
Bronchitis/Emphysema	No	146	189.048	234.959	19.445	1	930	5	15	57.5	360	585	645	700	748		
Bronchitis/Emphysema	Yes	7	225	239.948	90.692	5	555	5	5	95	510	555	555	555	555		

Note: A "\*" Signifies missing data. Refused = Refused data. N = doer sample size. Mean = Mean 24-hour cumulative number of minutes for doers. Stdev = standard deviation. Stderr = standard error. Min = minimum number of minutes. Max = maximum number of minutes. Percentiles are the percentage of doers below or equal to a given number of minutes.

Source: Tsang and Klepeis, 1996.



Table 15-96. Statistics for 24-Hour Cumulative Numbr of Minutes Spent Indoors at a Gym/Health Club

Category	Population Group	N	Mean	Stdev	Stderr	Min	Max	Percentiles								
								5	25	50	75	90	95	98	99	
All		364	129.651	104.343	5.4691	5	686	30	60	110	155	240	320	525	600	
Gender	Male	176	147.193	115.554	8.7102	5	686	30	77.5	120	175	285	360	533	660	
Gender	Female	188	113.229	89.876	6.5549	5	660	30	60	92.5	135	200	279	420	560	
Age (years)	*	6	202.5	227.854	93.0211	30	560	30	55	75	420	560	560	560	560	
Age (years)	1-4	5	156	29.875	13.3604	105	180	105	160	160	175	180	180	180	180	
Age (years)	5-11	28	105.286	69.537	13.1413	5	325	30	58	82.5	141	165	270	325	325	
Age (years)	12-17	39	165.385	122.056	19.5447	15	660	30	90	138	206	330	440	660	660	
Age (years)	18-64	254	123.134	98.827	6.2009	5	686	30	60	100	150	210	295	475	600	
Age (years)	> 64	32	141.375	114.216	20.1907	10	533	30	60	103	173	292	340	533	533	
Race	White	307	134.261	109.36	6.2415	5	686	30	65	110	164	255	330	533	600	
Race	Black	30	117.7	75.418	13.7693	5	320	10	60	115	145	235	285	320	320	
Race	Asian	10	75.2	36.484	11.5372	30	145	30	54	60	95	133	145	145	145	
Race	Some Others	11	112.909	69.077	20.8276	25	270	25	65	90	153	179	270	270	270	
Race	Hispanic	4	83.75	42.696	21.3478	40	140	40	52.5	77.5	115	140	140	140	140	
Race	Refused	2	57.5	3.536	2.5	55	60	55	55	57.5	60	60	60	60	60	
Hispanic	No	345	132.017	105.901	5.7015	5	686	30	65	110	160	240	325	533	600	
Hispanic	Yes	17	90.118	58.765	14.2527	5	255	5	60	90	115	140	255	255	255	
Hispanic	Refused	2	57.5	3.536	2.5	55	60	55	55	57.5	60	60	60	60	60	
Employment	*	72	139.625	103.274	12.171	5	660	30	76	120	165	265	330	440	660	
Employment	Full Time	176	131.193	112.511	8.4808	5	686	30	60	110	150	240	330	560	660	
Employment	Part Time	40	129.25	92.836	14.6787	25	420	35	60	95	168	285	325	420	420	
Employment	Not Employed	75	117.867	91.345	10.5477	5	533	25	60	90	145	230	285	475	533	
Employment	Refused	1	40	*	*	40	40	40	40	40	40	40	40	40	40	
Education	*	81	136.877	99.66	11.0733	5	660	30	75	120	164	215	325	440	660	
Education	< High School	9	110.556	97.706	32.5688	10	300	10	30	80	165	300	300	300	300	
Education	High School Graduate	61	128.475	110.005	14.0847	5	660	25	75	105	145	210	310	525	660	
Education	< College	71	145.634	129.073	15.3181	5	600	35	65	110	170	285	533	560	600	
Education	College Graduate	81	121.975	99.467	11.0519	15	686	30	60	98	135	220	285	420	686	
Education	Post Graduate	61	115.639	76.916	9.8481	10	415	40	60	90	145	225	265	320	415	
Census Region	Northeast	83	140.53	107.244	11.7716	20	660	40	70	120	170	240	330	600	660	
Census Region	Midwest	62	127	88.661	11.26	5	440	25	60	113	170	285	300	340	440	
Census Region	South	118	125.669	107.038	9.8537	5	660	15	60	105	150	240	330	533	540	
Census Region	West	101	126.99	108.452	10.7914	5	686	50	60	92	135	225	292	525	560	
Day Of Week	Weekday	281	121.26	96.577	5.7613	5	686	30	60	98	145	210	295	475	560	
Day Of Week	Weekend	83	158.06	123.652	13.5726	5	660	30	77	120	180	285	415	600	660	
Season	Winter	127	139.795	108.258	9.6063	5	686	25	75	120	177	240	330	533	660	
Season	Spring	85	141.459	115.229	12.4983	10	600	30	65	102	164	285	340	560	600	
Season	Summer	81	109.864	87.411	9.7123	5	525	30	60	90	130	160	310	440	525	
Season	Fall	71	119.944	98.963	11.7447	20	660	30	56	98	150	215	295	420	660	
Asthma	No	333	132.39	106.796	5.8524	5	686	30	62	110	160	255	325	533	600	
Asthma	Yes	28	100.071	69.387	13.113	5	330	25	60	86	118	210	230	330	330	
Asthma	DK	3	101.667	55.752	32.1887	60	165	60	60	80	165	165	165	165	165	
Angina	No	357	130.499	104.98	5.5561	5	686	30	62	110	155	240	325	525	600	
Angina	Yes	4	90	47.61	23.8048	60	160	60	60	70	120	160	160	160	160	
Angina	DK	3	81.667	65.256	37.6755	30	155	30	30	60	155	155	155	155	155	
Bronchitis/Emphysema	No	352	130.696	104.843	5.5882	5	686	30	61	110	158	240	320	525	600	
Bronchitis/Emphysema	Yes	10	97.3	92.848	29.361	10	330	10	45	76.5	120	245	330	330	330	
Bronchitis/Emphysema	DK	2	107.5	67.175	47.5	60	155	60	60	108	155	155	155	155	155	

Note: A "\*" Signifies missing data. "DK" = The respondent replied "don't know". Refused = Refused data. N = doer sample size. Mean = Mean 24-hour cumulative number of minutes for doers. Stdev = standard deviation. Stderr = standard error. Min = minimum number of minutes. Max = maximum number of minutes. Percentiles are the percentage of doers below or equal to a given number of minutes.  
Source: Tsang and Klepeis, 1996.



Table 15-97. Statistics for 24-Hour Cumulative Number of Minutes Spent Indoors at the Laundromat

Category	Population Group	N	Mean	Stdev	Stderr	Min	Max	Percentiles									
								5	25	50	75	90	95	98	99		
All		40	99.275	85.209	13.4727	2	500	5	54.5	91	120	153	238	500	500		
Gender	Male	9	150.222	146.822	48.9407	2	500	2	115	120	150	500	500	500	500		
Gender	Female	31	84.484	51.822	9.3075	5	265	5	50	80	115	137	155	265	265		
Age (years)	5-11	3	80.667	17.926	10.3494	60	92	60	60	90	92	92	92	92	92		
Age (years)	18-64	33	101.182	91.724	15.967	2	500	5	50	90	120	155	265	500	500		
Age (years)	> 64	4	97.5	63.574	31.7871	5	150	5	60	118	135	150	150	150	150		
Race	White	31	102.161	93.832	16.8527	2	500	5	50	90	120	155	265	500	500		
Race	Black	6	75.667	50.306	20.5372	5	130	5	34	85	115	130	130	130	130		
Race	Hispanic	3	116.667	30.551	17.6383	90	150	90	90	110	150	150	150	150	150		
Hispanic	No	37	97.865	88.241	14.5068	2	500	5	50	90	120	155	265	500	500		
Hispanic	Yes	3	116.667	30.551	17.6383	90	150	90	90	110	150	150	150	150	150		
Employment	*	3	80.667	17.926	10.3494	60	92	60	60	90	92	92	92	92	92		
Employment	Full Time	20	97.6	104.739	23.4203	2	500	4	42	83.5	115	143	328	500	500		
Employment	Part Time	4	127.5	91.879	45.9393	75	265	75	77.5	85	178	265	265	265	265		
Employment	Not Employed	13	97.462	60.852	16.8772	5	210	5	45	115	137	150	210	210	210		
Education	*	3	80.667	17.926	10.3494	60	92	60	60	90	92	92	92	92	92		
Education	< High School	6	95	53.292	21.7562	5	150	5	60	113	130	150	150	150	150		
Education	High School Graduate	17	101.353	64.434	15.6275	5	265	5	59	90	120	210	265	265	265		
Education	< College	6	91.5	56.387	23.0199	10	155	10	34	115	120	155	155	155	155		
Education	College Graduate	7	126.429	168.219	63.5808	5	500	5	45	70	110	500	500	500	500		
Education	Post Graduate	1	2	*	*	2	2	2	2	2	2	2	2	2	2		
Census Region	Northeast	6	168.667	166.465	67.9591	45	500	45	75	126	140	500	500	500	500		
Census Region	Midwest	8	94	60.328	21.3291	5	210	5	57.5	93.5	118	210	210	210	210		
Census Region	South	18	85.944	61.82	14.5711	2	265	2	50	76	115	155	265	265	265		
Census Region	West	8	82.5	52.915	18.7083	5	150	5	35	100	118	150	150	150	150		
Day Of Week	Weekday	25	103.32	100.663	20.1326	2	500	5	50	90	115	155	265	500	500		
Day Of Week	Weekend	15	92.533	52.697	13.6063	10	210	10	60	92	130	150	210	210	210		
Season	Winter	11	86.455	57.98	17.4816	2	210	2	45	80	120	140	210	210	210		
Season	Spring	12	85.583	71.678	20.6916	5	265	5	35	73.5	120	130	265	265	265		
Season	Summer	12	118.667	125.78	36.3096	5	500	5	55	101	113	137	500	500	500		
Season	Fall	5	113.8	48.422	21.655	34	155	34	115	115	150	155	155	155	155		
Asthma	No	37	95.459	83.88	13.7897	2	500	5	50	90	120	150	210	500	500		
Asthma	Yes	3	146.333	106.514	61.4962	59	265	59	59	115	265	265	265	265	265		
Angina	No	40	99.275	85.209	13.4727	2	500	5	54.5	91	120	153	238	500	500		
Bronchitis/Emphysema	No	35	92.314	84.343	14.2565	2	500	5	50	90	115	130	210	500	500		
Bronchitis/Emphysema	Yes	5	148	83.262	37.2357	30	265	30	140	150	155	265	265	265	265		

Note: A "\*" Signifies missing data. N = doer sample size. Mean = Mean 24-hour cumulative number of minutes for doers. Stdev = standard deviation. Stderr = standard error. Min = minimum number of minutes. Max = maximum number of minutes. Percentiles are the percentage of doers below or equal to a given number of minutes.

Source: Tsang and Klepeis, 1996.



Table 15-98. Statistics for 24-Hour Cumulative Number of Minutes Spent Indoors at Work (non-specific)

Category	Population Group	N	Mean	Stdev	Stderr	Min	Max	Percentiles							
								5	25	50	75	90	95	98	99
All		137	393.949	242.649	20.731	5	979	15	180	440	555	662	810	940	960
Gender	Male	96	435.271	243.979	24.901	10	979	20	245	473	598	765	840	960	979
Gender	Female	41	297.195	212.415	33.174	5	780	15	90	280	495	550	590	780	780
Age (years)	*	4	568.75	394.723	197.362	90	940	90	248	623	890	940	940	940	940
Age (years)	1-4	2	200	70.711	50	150	250	150	150	200	250	250	250	250	250
Age (years)	5-11	4	33.75	11.087	5.543	20	45	20	25	35	42.5	45	45	45	45
Age (years)	12-17	2	207.5	166.17	117.5	90	325	90	90	208	325	325	325	325	325
Age (years)	18-64	121	409.678	230.934	20.994	5	979	15	240	450	560	660	793	850	960
Age (years)	> 64	4	293.75	289.464	144.732	10	610	10	50	278	538	610	610	610	610
Race	White	113	397.903	235.199	22.126	5	979	15	210	450	555	660	780	940	960
Race	Black	13	379.231	286.501	79.461	10	850	10	85	405	510	810	850	850	850
Race	Some Others	1	405	*	*	405	405	405	405	405	405	405	405	405	405
Race	Hispanic	9	314.778	266.161	88.72	30	793	30	95	245	440	793	793	793	793
Race	Refused	1	840	*	*	840	840	840	840	840	840	840	840	840	840
Hispanic	No	121	388.702	242.092	22.008	5	979	15	180	405	550	660	795	940	960
Hispanic	Yes	12	361.083	242.06	69.877	30	793	30	138	370	510	660	793	793	793
Hispanic	DK	2	585	35.355	25	560	610	560	560	585	610	610	610	610	610
Hispanic	Refused	2	717.5	173.241	122.5	595	840	595	595	718	840	840	840	840	840
Employment	*	8	118.75	113.916	40.275	20	325	20	35	67.5	200	325	325	325	325
Employment	Full Time	97	440.732	237.56	24.121	10	979	15	300	480	585	690	815	960	979
Employment	Part Time	21	341.19	188.235	41.076	30	795	115	240	330	435	590	610	795	795
Employment	Not Employed	9	250.556	218.567	72.856	5	630	5	95	150	360	630	630	630	630
Employment	Refused	2	425	586.899	415	10	840	10	10	425	840	840	840	840	840
Education	*	11	234.091	266.306	80.294	20	840	20	40	150	325	610	840	840	840
Education	< High School	12	460.417	181.727	52.46	115	795	115	330	495	558	615	795	795	795
Education	High School Graduate	50	409.6	273.717	38.709	5	979	15	150	463	619	735	940	969.5	979
Education	< College	29	368.897	237.58	44.117	10	850	10	160	405	510	660	765	850	850
Education	College Graduate	22	405.682	184.225	39.277	90	815	150	240	375	540	595	645	815	815
Education	Post Graduate	13	443.692	218.128	60.498	10	793	10	360	500	585	630	793	793	793
Census Region	Northeast	22	405.545	193.817	41.322	15	765	90	320	398	540	660	662	765	765
Census Region	Midwest	26	418.577	250.898	49.205	10	940	13	180	473	610	690	780	940	940
Census Region	South	58	379.707	233.179	30.618	5	979	10	150	420	540	619	810	815	979
Census Region	West	31	391.71	289.538	52.003	10	960	20	90	405	630	795	850	960	960
Day Of Week	Weekday	121	401.843	242.472	22.043	5	979	15	210	450	560	660	810	940	960
Day Of Week	Weekend	16	334.25	243.28	60.82	13	795	13	97.5	340	495	690	795	795	795
Season	Winter	42	390.81	241.456	37.257	10	960	30	175	405	550	660	765	960	960
Season	Spring	34	361.324	236.996	40.644	10	840	30	150	360	525	660	815	840	840
Season	Summer	41	400.902	262.9	41.058	5	979	13	210	450	570	690	810	979	979
Season	Fall	20	441.75	219.411	49.062	10	793	12.5	285	490	620	661	727.5	793	793
Asthma	No	124	393.218	237.29	21.309	5	960	20	180	440	553	660	795	850	940
Asthma	Yes	13	400.923	300.15	83.247	10	979	10	240	320	590	793	979	979	979
Angina	No	133	397.677	243.291	21.096	5	979	15	190	440	555	662	810	940	960
Angina	Yes	3	266.667	255.799	147.686	90	560	90	90	150	560	560	560	560	560
Angina	DK	1	280	*	*	280	280	280	280	280	280	280	280	280	280
Bronchitis/Emphysema	No	131	397.13	242.048	21.148	5	979	20	180	440	555	662	810	940	960
Bronchitis/Emphysema	Yes	5	333.4	299.365	133.88	10	619	10	13	460	565	619	619	619	619
Bronchitis/Emphysema	DK	1	280	*	*	280	280	280	280	280	280	280	280	280	280

Note: A "\*" Signifies missing data. "DK" = The respondent replied "don't know". Refused = Refused data. N = doer sample size. Mean = Mean 24-hour cumulative number of minutes for doers. Stdev = standard deviation. Stderr = standard error. Min = minimum number of minutes. Max = maximum number of minutes. Percentiles are the percentage of doers below or equal to a given number of minutes.  
Source: Tsang and Klepeis, 1996.



Table 15-99. Statistics for 24-Hour Cumulative Number of Minutes Spent Indoors at the Dry Cleaners

Category	Population Group	N	Mean	Stdev	Stderr	Min	Max	Percentiles									
								5	25	50	75	90	95	98	99		
All		34	82.029	151.651	26.008	2	515	5	5	10	90	325	500	515	515		
Gender	Male	11	105.545	166.006	50.053	2	515	2	5	10	103	325	515	515	515		
Gender	Female	23	70.783	146.839	30.618	5	500	5	5	10	35	300	485	500	500		
Age (years)	*	1	485	*	*	485	485	485	485	485	485	485	485	485	485		
Age (years)	1-4	2	20	21.213	15	5	35	5	5	20	35	35	35	35	35		
Age (years)	18-64	28	61.036	120.923	22.852	2	515	5	5	10	55	300	325	515	515		
Age (years)	> 64	3	185	273.359	157.824	10	500	10	10	45	500	500	500	500	500		
Race	White	25	70.72	143.744	28.749	2	515	5	5	10	35	300	485	515	515		
Race	Black	7	131.429	198.95	75.196	5	500	5	10	20	325	500	500	500	500		
Race	Some Others	1	10	*	*	10	10	10	10	10	10	10	10	10	10		
Race	Hispanic	1	91	*	*	91	91	91	91	91	91	91	91	91	91		
Hispanic	No	31	83.806	158.483	28.464	2	515	5	5	10	45	325	500	515	515		
Hispanic	Yes	3	63.667	46.479	26.835	10	91	10	10	90	91	91	91	91	91		
Employment	*	2	20	21.213	15	5	35	5	5	20	35	35	35	35	35		
Employment	Full Time	25	83.12	151.81	30.362	2	515	5	5	10	90	325	485	515	515		
Employment	Part Time	1	500	*	*	500	500	500	500	500	500	500	500	500	500		
Employment	Not Employed	6	28.5	33.934	13.853	5	91	5	10	10	45	91	91	91	91		
Education	*	2	20	21.213	15	5	35	5	5	20	35	35	35	35	35		
Education	< High School	4	234	209.191	104.595	45	500	45	68	196	400	500	500	500	500		
Education	High School Graduate	8	84.125	165.008	58.339	5	485	5	13	17.5	62	485	485	485	485		
Education	< College	6	146.333	220.347	89.956	5	515	5	10	11.5	325	515	515	515	515		
Education	College Graduate	12	13.5	24.247	6.999	2	90	2	5	5	10	10	90	90	90		
Education	Post Graduate	2	50	63.64	45	5	95	5	5	50	95	95	95	95	95		
Census Region	Northeast	8	110	187.293	66.218	5	485	5	5	10	180	485	485	485	485		
Census Region	Midwest	10	19.1	30.101	9.519	5	103	5	5	7.5	20	61.5	103	103	103		
Census Region	South	8	197	211.975	74.945	15	515	15	30	93	400	515	515	515	515		
Census Region	West	8	17.75	29.359	10.38	2	90	2	5	10	10	90	90	90	90		
Day Of Week	Weekday	23	93.957	172.77	36.025	2	515	5	5	10	90	485	500	515	515		
Day Of Week	Weekend	11	57.091	95.985	28.941	5	325	5	5	10	95	103	325	325	325		
Season	Winter	12	74.583	158.092	45.637	5	485	5	5	10	13	325	485	485	485		
Season	Spring	4	44.5	41.685	20.843	10	103	10	15	32.5	74	103	103	103	103		
Season	Summer	8	20.25	32.012	11.318	2	95	2	5	5	23	95	95	95	95		
Season	Fall	10	155.4	205.739	65.061	5	515	5	13	55	300	507.5	515	515	515		
Asthma	No	32	86.688	155.244	27.443	2	515	5	5	11.5	91	325	500	515	515		
Asthma	Yes	2	7.5	3.536	2.5	5	10	5	5	7.5	10	10	10	10	10		
Angina	No	33	83.909	153.599	26.738	2	515	5	5	10	90	325	500	515	515		
Angina	Yes	1	20	*	*	20	20	20	20	20	20	20	20	20	20		
Bronchitis/Emphysema	No	33	84.061	153.532	26.726	2	515	5	5	10	90	325	500	515	515		
Bronchitis/Emphysema	Yes	1	15	*	*	15	15	15	15	15	15	15	15	15	15		

Note: A "\*" Signifies missing data. N = doer sample size. Mean = Mean 24-hour cumulative number of minutes for doers. Stdev = standard deviation. Stderr = standard error. Min = minimum number of minutes. Max = maximum number of minutes. Percentiles are the percentage of doers below or equal to a given number of minutes.  
Source: Tsang and Klepeis, 1996.



Table 15-100. Statistics for 24-Hour Cumulative Number of Minutes Spent Indoors at a Bar/Nightclub/Bowling Alley

Category	Population Group	N	Mean	Stdev	Stderr	Min	Max	Percentiles								
								5	25	50	75	90	95	98	99	
All		352	175.818	132.206	7.047	3	870	30	90	150	222.5	328	487	570	615	
Gender	Male	213	174.319	133.151	9.123	5	870	30	90	140	220	340	479	568	615	
Gender	Female	139	178.115	131.191	11.127	3	630	30	95	150	225	300	530	600	605	
Age (years)	*	4	158.75	98.011	49.006	75	300	75	98	130	220	300	300	300	300	
Age (years)	5-11	4	98.75	57.5	28.75	45	170	45	53	90	145	170	170	170	170	
Age (years)	12-17	8	151.25	77.678	27.463	50	270	50	80	160	205	270	270	270	270	
Age (years)	18-64	313	180.192	136.706	7.727	3	870	30	90	150	225	370	498	590	615	
Age (years)	> 64	23	141.217	85.243	17.774	5	328	30	75	135	180	240	325	328	328	
Race	White	297	173.623	132.592	7.694	3	870	30	90	140	220	328	487	590	630	
Race	Black	25	205.44	126.551	25.31	50	540	60	120	180	240	417	498	540	540	
Race	Asian	8	169.875	153.311	54.204	5	479	5	38	175	225	479	479	479	479	
Race	Some Others	7	197.286	187.607	70.909	70	615	70	110	135	185	615	615	615	615	
Race	Hispanic	10	121.3	52.326	16.547	5	198	5	105	117.5	160	179	198	198	198	
Race	Refused	5	246.6	127.153	56.864	73	410	73	180	270	300	410	410	410	410	
Hispanic	No	327	177.131	134.457	7.435	3	870	30	90	150	225	340	489	590	615	
Hispanic	Yes	20	144.9	85.08	19.024	5	440	38	110	120	160	221.5	342.5	440	440	
Hispanic	DK	2	142.5	31.82	22.5	120	165	120	120	142.5	165	165	165	165	165	
Hispanic	Refused	3	261	171.852	99.219	73	410	73	73	300	410	410	410	410	410	
Employment	*	12	133.75	73.55	21.232	45	270	45	60	135	177.5	225	270	270	270	
Employment	Full Time	223	182.439	138.308	9.262	5	870	30	90	150	228	340	525	600	630	
Employment	Part Time	43	201.233	155.454	23.706	5	615	45	90	150	270	455	520	615	615	
Employment	Not Employed	70	146.3	97.375	11.639	3	479	30	73	122.5	180	255	328	462	479	
Employment	Refused	4	176.25	115.136	57.568	45	300	45	83	180	270	300	300	300	300	
Education	*	13	146.538	84.172	23.345	45	300	45	60	150	185	270	300	300	300	
Education	< High School	28	218.036	170.225	32.17	60	870	75	120	174.5	235	420	568	870	870	
Education	High School Graduate	117	177.778	130.078	12.026	3	630	25	90	150	225	360	489	540	570	
Education	< College	95	205.274	152.829	15.68	5	650	30	105	180	240	462	590	615	650	
Education	College Graduate	55	141.764	92.766	12.509	10	417	20	75	120	205	265	340	410	417	
Education	Post Graduate	44	131.364	90.209	13.599	30	400	30	60	110	177.5	265	290	400	400	
Census Region	Northeast	83	179.337	137.039	15.042	5	650	45	89	140	240	328	489	630	650	
Census Region	Midwest	88	169.818	126.238	13.457	5	615	30	90	147.5	211.5	299	487	568	615	
Census Region	South	91	175.714	132.028	13.84	3	870	35	90	148	225	270	462	570	870	
Census Region	West	90	178.544	135.533	14.286	5	605	30	85	152.5	225	407	479	590	605	
Day Of Week	Weekday	192	167.458	133.473	9.633	5	650	30	80	120	210	340	520	590	605	
Day Of Week	Weekend	160	185.85	130.378	10.307	3	870	45	108	165	228	321.5	474.5	568	630	
Season	Winter	93	182.667	131.674	13.654	5	650	40	87	150	240	410	455	560	650	
Season	Spring	83	186.12	147.597	16.201	5	870	30	90	140	230	380	498	570	870	
Season	Summer	99	160.313	130.672	13.133	3	630	30	75	120	189	285	530	605	630	
Season	Fall	77	176.377	117.154	13.351	15	615	30	100	165	220	299	410	600	615	
Asthma	No	331	176.308	133.715	7.35	3	870	30	90	150	225	340	487	590	615	
Asthma	Yes	18	169.444	108.978	25.686	60	530	60	105	135	210	270	530	530	530	
Asthma	DK	3	160	124.9	72.111	60	300	60	60	120	300	300	300	300	300	
Angina	No	345	176.98	132.759	7.148	3	870	30	90	150	225	340	487	590	615	
Angina	Yes	5	82	47.249	21.131	5	120	5	75	90	120	120	120	120	120	
Angina	DK	2	210	127.279	90	120	300	120	120	210	300	300	300	300	300	
Bronchitis/Emphysema	No	333	177.273	133.27	7.303	3	870	30	90	150	225	340	487	590	615	
Bronchitis/Emphysema	Yes	17	148.588	108.499	26.315	50	530	50	110	120	175	210	530	530	530	
Bronchitis/Emphysema	DK	2	165	190.919	135	30	300	30	30	165	300	300	300	300	300	

Note: A "\*" Signifies missing data. "DK" = The respondent replied "don't know". Refused = Refused data. N = doer sample size. Mean = Mean 24-hour cumulative number of minutes for doers. Stdev = standard deviation. Stderr = standard error. Min = minimum number of minutes. Max = maximum number of minutes. Percentiles are the percentage of doers below or equal to a given number of minutes.  
Source: Tsang and Klepeis, 1996.



Table 15-101. Statistics for 24-Hour Cumulative Number of Minutes Spent Indoors at a Restaurant

Category	Population Group	N	Mean	Stdev	Stderr	Min	Max	Percentiles									
								5	25	50	75	90	95	98	99		
All		2059	94.539	119.93	2.643	1	925	10	30	60	95	185	351	548	660		
Gender	Male	986	87.498	114.17	3.6358	1	900	10	30	60	90	160	305	550	660		
Gender	Female	1073	101.01	124.69	3.8065	1	925	10	40	60	105	230	380	540	670		
Age (years)	*	30	126.13	138.22	25.2349	15	495	30	45	60	150	397.5	490	495	495		
Age (years)	1-4	61	62.705	47.701	6.1075	4	330	10	35	55	85	115	120	130	330		
Age (years)	5-11	84	56.69	38.144	4.1618	5	180	10	30	45	85	120	120	140	180		
Age (years)	12-17	122	69.836	78.361	7.0945	2	455	10	30	45	65	165	250	325	360		
Age (years)	18-64	1503	101.21	131.22	3.3846	1	925	10	30	60	105	211	400	570	675		
Age (years)	> 64	259	83.583	83.517	5.1895	3	750	19	45	60	90	150	215	315	520		
Race	White	1747	91.658	114.69	2.744	1	925	10	30	60	95	175	320	535	640		
Race	Black	148	102.82	141.28	11.613	3	805	5	30	60	95	295	430	555	735		
Race	Asian	37	81.297	78.948	12.979	15	480	18	30	60	90	135	200	480	480		
Race	Some Others	30	145.17	194.83	35.5705	5	765	10	45	82.5	120	432.5	750	765	765		
Race	Hispanic	78	123	156.78	17.7518	10	700	15	40	60	110	375	585	660	700		
Race	Refused	19	123.84	127.64	29.2833	20	480	20	30	70	210	330	480	480	480		
Hispanic	No	1911	92.945	117.6	2.6901	1	925	10	30	60	95	180	330	542	645		
Hispanic	Yes	129	116.7	147.95	13.0261	1	765	15	40	60	115	360	435	660	700		
Hispanic	DK	5	76	134.32	60.0708	5	315	5	10	10	40	315	315	315	315		
Hispanic	Refused	14	114.5	134.74	36.0117	30	480	30	30	60	90	330	480	480	480		
Employment	*	263	62.251	57.907	3.5707	2	455	10	30	45	80	120	140	273	330		
Employment	Full Time	1063	105.48	142.37	4.3668	1	925	10	35	60	105	235	485	630	735		
Employment	Part Time	208	122.61	144.83	10.0423	1	805	5	32.5	65	122.5	320	441	595	660		
Employment	Not Employed	515	76.33	61.418	2.7064	3	490	15	40	60	90	145	195	260	315		
Employment	Refused	10	135	133.52	42.223	30	425	30	60	82.5	135	377.5	425	425	425		
Education	*	299	72.177	79.595	4.6031	1	548	10	30	50	85	130	250	360	480		
Education	< High School	132	134.77	171.84	14.9567	5	925	10	30	60	151.5	375	535	700	750		
Education	High School Graduate	590	99.439	136.32	5.612	3	910	10	35	60	90	202.5	435	645	680		
Education	< College	431	94.935	114.88	5.5338	1	770	10	35	60	105	180	340	550	640		
Education	College Graduate	359	89.515	104.13	5.4957	1	765	10	35	60	100	165	295	490	570		
Education	Post Graduate	248	95.012	109.37	6.9452	3	765	15	40	60	115	180	260	560	675		
Census Region	Northeast	409	94.379	113.64	5.619	2	765	15	35	60	100	210	330	507	585		
Census Region	Midwest	504	96.895	120.86	5.3833	1	805	10	30	60	105	190	340	560	675		
Census Region	South	680	92.666	125.1	4.7972	2	910	10	30	60	90	194.5	365	550	650		
Census Region	West	466	94.863	116.88	5.4145	1	925	10	30	60	110	175	375	535	640		
Day Of Week	Weekday	1291	97.338	128.83	3.5855	1	925	10	30	60	93	210	377	555	700		
Day Of Week	Weekend	768	89.833	103.16	3.7224	1	770	10	36	60	105	155	280	510	620		
Season	Winter	524	97.735	125.69	5.491	3	875	15	35	60	105	178	351	595	685		
Season	Spring	559	91.642	109.7	4.6399	2	925	10	35	60	95	180	360	505	555		
Season	Summer	556	95.121	123.03	5.2177	1	910	10	30	60	94	210	360	555	675		
Season	Fall	420	93.636	121.74	5.9401	1	900	10	30	60	95	185	325	540	653		
Asthma	No	1903	94.081	117.41	2.6915	1	910	10	35	60	100	180	330	545	653		
Asthma	Yes	150	96.267	143.56	11.7219	4	925	10	30	45.5	90	237.5	485	590	670		
Asthma	DK	6	196.33	220.89	90.1782	30	480	30	30	79	480	480	480	480	480		
Angina	No	1998	94.926	120.73	2.701	1	925	10	30	60	100	190	355	550	660		
Angina	Yes	50	68.98	53.608	7.5813	3	340	15	45	60	90	105	120	286	340		
Angina	DK	11	140.27	171.27	51.6393	30	480	30	30	70	120	480	480	480	480		
Bronchitis/Emphysema	No	1945	93.746	117.67	2.668	1	910	10	30	60	97	180	335	548	653		
Bronchitis/Emphysema	Yes	104	96.077	130.13	12.7602	5	925	15	30	60	90	235	360	500	620		
Bronchitis/Emphysema	DK	10	232.8	288.24	91.1492	10	875	10	30	79	480	677.5	875	875	875		

Note: A "\*" Signifies missing data. "DK" = The respondent replied "don't know". Refused = Refused data. N = doer sample size. Mean = Mean 24-hour cumulative number of minutes for doers. Stdev = standard deviation. Stderr = standard error. Min = minimum number of minutes. Max = maximum number of minutes. Percentiles are the percentage of doers below or equal to a given number of minutes.  
Source: Tsang and Klepeis, 1996.



Table 15-102. Statistics for 24-Hour Cumulative Number of Minutes Spent Indoors at School

Category	Population Group	N	Mean	Stdev	Stderr	Min	Max	Percentiles							
								5	25	50	75	90	95	98	99
All		1224	343.35	179.099	5.119	1	995	10	210	395	454	540	585	660	723
Gender	Male	581	358.599	167.7	6.957	1	995	30	255	400	450	540	600	690	778
Gender	Female	643	329.572	187.875	7.409	1	855	5	180	390	455	540	582	640	683
Age (years)	*	18	314.056	230.927	54.43	5	713	5	165	247.5	520	625	713	713	713
Age (years)	1-4	43	288.465	217.621	33.187	5	665	10	60	269	500	580	595	665	665
Age (years)	5-11	302	396.308	109.216	6.285	5	665	170	365	403	445	535	565	625	640
Age (years)	12-17	287	402.551	125.512	7.409	15	855	120	383	420	450	500	565	710	778
Age (years)	18-64	550	295.422	207.294	8.839	1	995	5	104	300	460	552.5	612	683	785
Age (years)	> 64	24	187.708	187.012	38.174	2	585	3	45	120	327.5	480	510	585	585
Race	White	928	348.525	180.458	5.924	1	995	10	212.5	400	458	545	600	665	723
Race	Black	131	339.809	169.282	14.79	2	855	15	230	390	445	510	580	624	645
Race	Asian	39	332.385	179.918	28.81	5	840	20	190	365	450	560	580	840	840
Race	Some Others	36	363.583	155.557	25.926	10	820	105	272.5	366	457.5	502	598	820	820
Race	Hispanic	76	294.039	175.697	20.154	2	565	10	142.5	362.5	432	495	525	540	565
Race	Refused	14	279.714	221.268	59.136	5	681	5	60	260	440	625	681	681	681
Hispanic	No	1082	344.924	179.58	5.459	1	995	10	210	395	455	540	598	665	730
Hispanic	Yes	127	333.016	173.803	15.423	2	820	15	200	390	445	500	565	600	630
Hispanic	DK	5	293	244.672	109.42	3	562	3	65	415	420	562	562	562	562
Hispanic	Refused	10	329.5	180.053	56.938	5	625	5	200	350	445	537.5	625	625	625
Employment	*	616	390.294	130.206	5.246	5	855	115	365	410	450	525	570	640	665
Employment	Full Time	275	331.269	222.021	13.388	1	995	5	115	405	510	575	625	690	755
Employment	Part Time	138	280.891	174.844	14.884	1	800	10	160	285	412	480	537	660	683
Employment	Not Employed	190	258.674	199.529	14.475	1	855	5	60	262.5	410	527.5	572	778	840
Employment	Refused	5	166	179.074	80.084	5	440	5	5	180	200	440	440	440	440
Education	*	679	388.943	132.842	5.098	5	855	100	360	410	450	525	580	640	710
Education	< High School	24	233.333	179.648	36.67	1	540	2	30	297.5	373.5	460	465	540	540
Education	High School Graduate	114	186.649	193.608	18.133	1	785	4	20	107.5	295	480	580	645	690
Education	< College	173	281.41	209.872	15.956	1	995	5	120	255	425	550	640	820	855
Education	College Graduate	93	300.43	208.704	21.642	1	755	5	115	320	470	540	580	730	755
Education	Post Graduate	141	373.525	193.443	16.291	1	683	15	250	442	510	575	615	655	680
Census Region	Northeast	261	345.724	181.522	11.236	1	995	11	210	385	455	535	620	710	855
Census Region	Midwest	290	334.445	176.652	10.373	1	730	10	180	390	440	530	585	645	683
Census Region	South	427	354.037	178.547	8.641	1	855	10	235	415	462	540	575	640	755
Census Region	West	246	332.78	180.277	11.494	1	820	15	195	377.5	440	555	595	681	713
Day Of Week	Weekday	1179	346.838	177.477	5.169	1	995	10	222	395	455	540	585	655	723
Day Of Week	Weekend	45	251.978	198.543	29.597	20	820	40	105	180	360	555	632	820	820
Season	Winter	392	369.298	164.363	8.302	1	855	20	285	405	457	545	600	680	710
Season	Spring	353	355.057	165.488	8.808	1	855	12	250	400	455	535	575	636	713
Season	Summer	207	316.763	196.364	13.648	2	995	10	125	365	445	557	585	640	723
Season	Fall	272	310.996	195.332	11.844	1	855	5	120	365	445	540	595	660	778
Asthma	No	1095	342.779	179.195	5.415	1	995	10	200	390	455	540	585	660	723
Asthma	Yes	124	350.669	178.785	16.055	1	855	10	250	401.5	445	535	605	645	800
Asthma	DK	5	287	190.676	85.273	5	445	5	180	365	440	445	445	445	445
Angina	No	1209	344.629	178.874	5.144	1	995	10	210	395	455	540	595	660	723
Angina	Yes	9	205.778	169.545	56.515	15	510	15	90	180	275	510	510	510	510
Angina	DK	6	292.167	178.908	73.039	5	480	5	180	324	440	480	480	480	480
Bronchitis/Emphysema	No	1175	344.826	178.845	5.217	1	995	10	212	395	455	540	595	660	730
Bronchitis/Emphysema	Yes	42	306.714	188.249	29.047	3	632	10	120	377.5	444	465	580	632	632
Bronchitis/Emphysema	DK	7	315.429	163.691	61.869	5	440	5	180	378	440	440	440	440	440

Note: A "\*" Signifies missing data. "DK" = The respondent replied "don't know". Refused = Refused data. N = doer sample size. Mean = Mean 24-hour cumulative number of minutes for doers. Stdev = standard deviation. Stderr = standard error. Min = minimum number of minutes. Max = maximum number of minutes. Percentiles are the percentage of doers below or equal to a given number of minutes. Source: Tsang and Klepeis, 1996.





Table 15-103. Statistics for 24-Hour Cumulative Number of Minutes Spent Indoors at a Plant/Factory/Warehouse

Category	Population Group	N	Mean	Stdev	Stderr	Min	Max	Percentiles								
								5	25	50	75	90	95	98	99	
All		383	450.896	204.367	10.443	2	997	30	350	510	568	670	705	770	855	
Gender	Male	271	460.458	205.102	12.459	2	997	30	365	515	575	675	720	780	870	
Gender	Female	112	427.759	201.609	19.05	5	820	15	314.5	510	555	600	675	705	720	
Age (years)	*	6	405.667	304.05	124.13	30	780	30	120	414.5	675	780	780	780	780	
Age (years)	1-4	1	20	*	*	20	20	20	20	20	20	20	20	20	20	
Age (years)	5-11	2	107.5	123.744	87.5	20	195	20	20	107.5	195	195	195	195	195	
Age (years)	12-17	4	108	136.404	68.202	10	307	10	20	57.5	196	307	307	307	307	
Age (years)	18-64	353	463.683	196.321	10.449	5	997	30	385	520	570	670	705	770	855	
Age (years)	> 64	17	347.765	210.909	51.153	2	705	2	180	450	495	550	705	705	705	
Race	White	322	451.789	201.135	11.209	5	890	30	355	517.5	568	650	690	770	840	
Race	Black	32	466.438	172.559	30.504	2	750	30	382.5	497.5	550	675	720	750	750	
Race	Asian	3	263.333	378.462	218.51	30	700	30	30	60	700	700	700	700	700	
Race	Some Others	6	585.333	156.91	64.058	310	780	310	565	591	675	780	780	780	780	
Race	Hispanic	15	385.8	231.348	59.734	5	765	5	230	435	515	760	765	765	765	
Race	Refused	5	440.4	387.419	173.26	30	997	30	115	520	540	997	997	997	997	
Hispanic	No	350	454.137	202.78	10.839	2	997	30	365	512.5	570	666.5	700	770	855	
Hispanic	Yes	26	419.615	213.155	41.803	5	765	15	240	482.5	550	675	760	765	765	
Hispanic	DK	2	425	162.635	115	310	540	310	310	425	540	540	540	540	540	
Hispanic	Refused	5	397	314.833	140.8	30	780	30	115	520	540	780	780	780	780	
Employment	*	7	95.286	113.83	43.024	10	307	10	20	30	195	307	307	307	307	
Employment	Full Time	333	481.417	185.222	10.15	5	997	50	440	525	580	675	720	780	855	
Employment	Part Time	23	359.87	170.619	35.577	40	585	45	240	390	505	527	535	585	585	
Employment	Not Employed	19	179.316	221.341	50.779	2	705	2	25	60	295	640	705	705	705	
Employment	Refused	1	30	*	*	30	30	30	30	30	30	30	30	30	30	
Education	*	13	184	234.182	64.95	10	780	10	20	85	270	510	780	780	780	
Education	< High School	38	491.237	195.919	31.782	2	855	5	435	525	600	705	765	855	855	
Education	High School Graduate	190	465.374	188.699	13.69	5	997	30	380	520	565	667.5	705	760	890	
Education	< College	85	450.494	199.674	21.658	15	870	40	375	510	565	635	680	820	870	
Education	College Graduate	43	463.163	206.51	31.492	5	840	60	405	520	600	670	690	840	840	
Education	Post Graduate	14	357.5	255.702	68.339	10	700	10	90	355	550	675	700	700	700	
Census Region	Northeast	71	449.423	207.98	24.683	5	890	15	300	510	565	675	725	780	890	
Census Region	Midwest	113	462.035	196.506	18.486	2	997	30	405	520	570	640	700	770	820	
Census Region	South	136	465.912	199.315	17.091	5	870	20	382	522.5	570	670	720	840	855	
Census Region	West	63	400.159	221.13	27.86	10	760	30	185	490	550	675	690	710	760	
Day Of Week	Weekday	319	476.445	190.875	10.687	5	997	30	435	525	580	675	710	770	855	
Day Of Week	Weekend	64	323.547	222.63	27.829	2	820	10	107.5	357.5	507.5	560	620	780	820	
Season	Winter	89	468.157	188.472	19.978	10	997	30	360	520	565	660	690	780	997	
Season	Spring	91	445.198	212.648	22.292	10	870	30	270	505	570	675	760	840	870	
Season	Summer	127	440.646	210.285	18.66	2	890	15	370	510	560	645	700	765	855	
Season	Fall	76	454.632	204.721	23.483	5	760	30	352.5	520	591	675	690	720	760	
Asthma	No	364	452.948	203.838	10.684	2	997	30	355	512.5	570	675	705	770	855	
Asthma	Yes	17	412.353	187.025	45.36	20	580	20	340	495	540	550	580	580	580	
Asthma	DK	2	405	530.33	375	30	780	30	30	405	780	780	780	780	780	
Angina	No	375	453.928	202.31	10.447	2	997	30	360	515	570	670	705	770	855	
Angina	Yes	5	231	168.389	75.306	60	475	60	90	230	300	475	475	475	475	
Angina	DK	3	438.333	379.418	219.06	30	780	30	30	505	780	780	780	780	780	
Bronchitis/Emphysema	No	362	450.235	204.588	10.753	2	997	30	350	510	565	663	700	770	855	
Bronchitis/Emphysema	Yes	19	468.316	175.293	40.215	50	720	50	375	510	568	690	720	720	720	
Bronchitis/Emphysema	DK	2	405	530.33	375	30	780	30	30	405	780	780	780	780	780	

Note: A "\*" Signifies missing data. "DK" = The respondent replied "don't know". Refused = Refused data. N = doer sample size. Mean = Mean 24-hour cumulative number of minutes for doers. Stdev = standard deviation. Stderr = standard error. Min = minimum number of minutes. Max = maximum number of minutes. Percentiles are the percentage of doers below or equal to a given number of minutes. Source: Tsang and Klepeis, 1996.



Table 15-104. Statistics for 24-Hour Cumulative Number of Minutes Spent Outdoors on a Sidewalk, Street, or in the Neighborhood

Category	Population Group	N	Mean	Stdev	Stderr	Min	Max	Percentiles									
								5	25	50	75	90	95	98	99		
All		896	85.785	133.828	4.4709	1	1440	2	15	40	90	223	405	565	615		
Gender	Male	409	108.775	168.11	8.3125	1	1440	3	20	45	120	330	525	615	710		
Gender	Female	487	66.476	91.863	4.1627	1	580	1	15	35	75	152	255	435	465		
Age (years)	*	15	72.533	69.418	17.9236	1	290	1	40	55	90	120	290	290	290		
Age (years)	1-4	30	54.8	52.731	9.6274	1	235	2	10	42.5	78	125	158	235	235		
Age (years)	5-11	75	110.813	116.76	13.4823	1	540	5	20	65	178	240	410	465	540		
Age (years)	12-17	74	52.554	74.776	8.6925	1	435	2	15	30	60	125	200	338	435		
Age (years)	18-64	580	94.279	153.933	6.3917	1	1440	2	15	40	82.5	277.5	480	600	690		
Age (years)	> 64	122	59.418	61.519	5.5696	1	380	2	20	40	75	120	190	235	270		
Race	White	727	85.735	136.504	5.0627	1	1440	2	15	41	90	215	405	570	675		
Race	Black	87	89.184	132.669	14.2236	1	565	2	10	35	120	324	426	540	565		
Race	Asian	11	88.727	114.01	34.3752	2	405	2	30	45	120	149	405	405	405		
Race	Some Others	18	80.556	105.981	24.98	10	420	10	20	40	75	240	420	420	420		
Race	Hispanic	42	71.357	110.769	17.092	1	525	1	20	40	75	135	290	525	525		
Race	Refused	11	122.909	117.699	35.4876	2	310	2	40	60	290	300	310	310	310		
Hispanic	No	807	87.482	136.129	4.792	1	1440	2	15	45	90	225	410	565	600		
Hispanic	Yes	79	67.797	110.301	12.4098	1	615	1	15	30	62	140	300	525	615		
Hispanic	DK	1	2	*	*	2	2	2	2	2	2	2	2	2	2		
Hispanic	Refused	9	100.778	115.933	38.6443	2	310	2	40	60	90	310	310	310	310		
Employment	*	176	79.182	96.345	7.2622	1	540	2	15	45	110	200	260	435	465		
Employment	Full Time	384	102.221	169.534	8.6515	1	1440	3	15	40.5	75	330	525	600	710		
Employment	Part Time	74	74.446	113.86	13.2359	1	795	1	15	42.5	86	180	255	390	795		
Employment	Not Employed	255	69.996	94.045	5.8893	1	615	1	15	40	85	152	270	380	485		
Employment	Refused	7	45.143	36.64	13.8485	2	90	2	4	40	90	90	90	90	90		
Education	*	198	74.914	92.253	6.5561	1	540	2	15	40.5	90	185	240	435	465		
Education	< High School	56	131.232	247.289	33.0454	1	1440	1	15	40	118	465	710	735	1440		
Education	High School Graduate	223	100.233	146.92	9.8385	1	795	5	20	45	95	275	480	600	680		
Education	< College	172	77.186	128.752	9.8173	1	675	1	10	30	75	180	435	570	600		
Education	College Graduate	138	76.275	106.589	9.0734	1	600	3	20	45	70	205	310	485	565		
Education	Post Graduate	109	78.229	121.311	11.6195	1	710	5	20	45	60	200	330	560	570		
Census Region	Northeast	202	89.134	132.343	9.3116	1	735	3	15	45	90	235	410	530	570		
Census Region	Midwest	193	87.855	153.329	11.0369	1	1440	2	15	30	85	240	355	565	600		
Census Region	South	298	79.943	125.46	7.2677	1	710	2	15	35	75	185	420	532	680		
Census Region	West	203	89.059	127.909	8.9775	1	795	1	20	45	105	210	300	570	615		
Day Of Week	Weekday	642	86.684	143.938	5.6808	1	1440	2	15	40	80	223	426	585	680		
Day Of Week	Weekend	254	83.512	104.207	6.5385	1	565	2	25	45	90	220	310	440	480		
Season	Winter	210	73.548	144.308	9.9582	1	1440	1	15	33	60	160	270	560	710		
Season	Spring	242	97.913	137.243	8.8223	1	795	4	25	45	120	240	435	570	675		
Season	Summer	276	83.989	123.086	7.4089	1	690	4	15	45	90	200	420	525	580		
Season	Fall	168	86.56	131.855	10.1729	1	710	2	15	40	90	240	405	600	615		
Asthma	No	832	86.108	129.455	4.488	1	795	2	15	40	90	225	418	565	600		
Asthma	Yes	57	85.596	193.133	25.5811	1	1440	1	15	35	90	180	235	260	1440		
Asthma	DK	7	48.857	27.973	10.5727	2	90	2	30	60	60	90	90	90	90		
Angina	No	857	86.177	134.897	4.608	1	1440	2	15	40	90	223	410	565	615		
Angina	Yes	33	81.727	117.393	20.4356	1	465	1	17	45	60	250	380	465	465		
Angina	DK	6	52	29.257	11.9443	2	90	2	40	60	60	90	90	90	90		
Bronchitis/Emphysema	No	855	84.837	132.316	4.5251	1	1440	2	15	40	85	225	405	560	600		
Bronchitis/Emphysema	Yes	34	117.735	176.429	30.2574	3	735	8	30	45	120	215	690	735	735		
Bronchitis/Emphysema	DK	7	46.286	27.482	10.3871	2	90	2	32	40	60	90	90	90	90		

Note: A "\*" Signifies missing data. "DK" = The respondent replied "don't know". Refused = Refused data. N = doer sample size. Mean = Mean 24-hour cumulative number of minutes for doers. Stdev = standard deviation. Stderr = standard error. Min = minimum number of minutes. Max = maximum number of minutes. Percentiles are the percentage of doers below or equal to a given number of minutes. Source: Tsang and Klepeis, 1996.



Table 15-105. Statistics for 24-Hour Cumulative Number of Minutes Spent Outdoors in a Parking Lot

Category	Population Group	N	Mean	Stdev	Stderr	Min	Max	Percentiles							
								5	25	50	75	90	95	98	99
All		226	70.721	126.651	8.425	1	910	2	10	20	60	190	309	510	580
Gender	Male	106	100.34	167.159	16.236	1	910	5	15	30	110	315	495	580	720
Gender	Female	120	44.558	64.826	5.918	1	295	1	5	20	46.5	167.5	187.5	248	285
Age (years)	*	3	135	195	112.58	15	360	15	15	30	360	360	360	360	360
Age (years)	1-4	11	39.818	38.449	11.593	5	110	5	10	20	90	90	110	110	110
Age (years)	5-11	5	62	63.699	28.487	5	170	5	30	45	60	170	170	170	170
Age (years)	12-17	12	93.75	90.81	26.214	5	248	5	17.5	52	163	238	248	248	248
Age (years)	18-64	182	69.984	132.655	9.833	1	910	2	10	20	60	190	309	550	720
Age (years)	> 64	13	74.462	127.9	35.473	1	465	1	10	25	60	180	465	465	465
Race	White	180	72.122	128.299	9.563	1	910	2	10	20.5	64	205	302	510	720
Race	Black	18	102.444	167.776	39.545	2	580	2	6	27.5	130	495	580	580	580
Race	Asian	3	21.667	7.638	4.41	15	30	15	15	20	30	30	30	30	30
Race	Some Others	5	50	46.098	20.616	5	115	5	10	45	75	115	115	115	115
Race	Hispanic	17	25.706	39.365	9.547	1	165	1	10	10	20	60	165	165	165
Race	Refused	3	135	195	112.58	15	360	15	15	30	360	360	360	360	360
Hispanic	No	196	69.26	114.078	8.148	1	720	2	10	24	67.5	190	295	495	580
Hispanic	Yes	25	42.92	103.34	20.668	1	510	1	5	10	20	75	165	510	510
Hispanic	DK	2	465	629.325	445	20	910	20	20	465	910	910	910	910	910
Hispanic	Refused	3	135	195	112.58	15	360	15	15	30	360	360	360	360	360
Employment	*	26	55.577	59.88	11.743	5	238	5	15	30	90	145	170	238	238
Employment	Full Time	117	83.325	155.119	14.341	1	910	2	10	20	60	240	495	580	720
Employment	Part Time	37	75.378	114.734	18.862	1	465	1	5	21	90	180	450	465	465
Employment	Not Employed	43	37.093	46.8	7.137	1	210	1	10	20	60	90	134	210	210
Employment	Refused	3	135	195	112.58	15	360	15	15	30	360	360	360	360	360
Education	*	33	69.697	85.644	14.909	1	360	5	15	30	90	180	248	360	360
Education	< High School	16	73.25	176.778	44.194	2	720	2	7.5	22.5	32.5	165	720	720	720
Education	High School Graduate	83	83	124.358	13.65	1	580	5	10	25	90	215	315	495	580
Education	< College	49	75.898	162.674	23.239	1	910	2	10	20	60	210	450	910	910
Education	College Graduate	23	48.783	107.169	22.346	1	510	2	5	10	30	130	135	510	510
Education	Post Graduate	22	35.5	54.472	11.613	1	185	1	5	15	30	115	180	185	185
Census Region	Northeast	56	57.357	82.622	11.041	1	495	1	12.5	27.5	75	135	180	295	495
Census Region	Midwest	48	73.438	118.574	17.115	1	550	5	10	25	62.5	248	315	550	550
Census Region	South	75	57.92	106.421	12.288	1	720	2	7	20	50	185	238	360	720
Census Region	West	47	104.298	189.916	27.702	3	910	5	10	20	90	450	510	910	910
Day Of Week	Weekday	154	64.851	136.686	11.014	1	910	2	7	20	43	180	450	550	720
Day Of Week	Weekend	72	83.278	101.675	11.982	1	465	5	15	35	113	240	309	360	465
Season	Winter	45	50.533	64.702	9.645	2	309	5	15	30	63	130	180	309	309
Season	Spring	57	82.912	131.245	17.384	1	495	1	10	20	90	240	465	495	495
Season	Summer	75	72.027	146.21	16.883	1	910	2	10	20	60	205	315	580	910
Season	Fall	49	73.082	133.165	19.024	1	720	1	10	20	75	205	295	720	720
Asthma	No	204	62.98	109.369	7.657	1	720	2	10	20	60	180	248	495	510
Asthma	Yes	18	149.722	238.456	56.205	1	910	1	15	45	145	580	910	910	910
Asthma	DK	4	110	166.883	83.442	15	360	15	22.5	32.5	198	360	360	360	360
Angina	No	217	69.263	127.076	8.626	1	910	2	10	20	60	185	309	510	580
Angina	Yes	5	99.6	83.056	37.144	35	238	35	40	75	110	238	238	238	238
Angina	DK	4	113.75	164.792	82.396	15	360	15	22.5	40	205	360	360	360	360
Bronchitis/Emphysema	No	211	65.555	114.21	7.863	1	720	2	10	20	60	180	295	495	550
Bronchitis/Emphysema	Yes	11	142.364	265.976	80.195	1	910	1	10	40	180	240	910	910	910
Bronchitis/Emphysema	DK	4	146.25	160.799	80.399	15	360	15	22.5	105	270	360	360	360	360

Note: A "\*" Signifies missing data. "DK" = The respondent replied "don't know". Refused = Refused data. N = doer sample size. Mean = Mean 24-hour cumulative number of minutes for doers. Stdev = standard deviation. Stderr = standard error. Min = minimum number of minutes. Max = maximum number of minutes. Percentiles are the percentage of doers below or equal to a given number of minutes.

Source: Tsang and Klepeis, 1996.



Table 15-106. Statistics for 24-Hour Cumulative Number of Minutes Spent Outdoors at a Service Station or Gas Station

Category	Population Group	N	Mean	Stdev	Stderr	Min	Max	Percentiles									
								5	25	50	75	90	95	98	99		
All		191	50.597	125.489	9.0801	1	790	5	5	10	20	105	365	570	645		
Gender	Male	90	73.522	149.969	15.8082	1	645	5	5	10	30	325	495	600	645		
Gender	Female	101	30.168	94.915	9.4444	2	790	5	5	10	15	44	105	180	510		
Age (years)	*	1	86	*	*	86	86	86	86	86	86	86	86	86	86		
Age (years)	1-4	3	6.667	2.887	1.6667	5	10	5	5	5	10	10	10	10	10		
Age (years)	5-11	3	66.667	98.277	56.7401	5	180	5	5	15	180	180	180	180	180		
Age (years)	12-17	11	7.818	4.513	1.3606	1	15	1	5	5	10	15	15	15	15		
Age (years)	18-64	157	54.185	135.636	10.8249	2	790	5	5	10	15	110	390	570	645		
Age (years)	> 64	16	47.813	69.497	17.3744	5	240	5	10	18	55	180	240	240	240		
Race	White	170	50.941	124.015	9.5115	2	790	5	5	10	20	107.5	365	520	600		
Race	Black	11	80.727	191.433	57.7192	4	645	4	5	5	44	140	645	645	645		
Race	Asian	1	5	*	*	5	5	5	5	5	5	5	5	5	5		
Race	Some Others	3	16.667	20.207	11.6667	5	40	5	5	5	40	40	40	40	40		
Race	Hispanic	5	10.2	7.596	3.3971	1	20	1	5	10	15	20	20	20	20		
Race	Refused	1	10	*	*	10	10	10	10	10	10	10	10	10	10		
Hispanic	No	179	53.056	129.15	9.6531	2	790	5	5	10	20	130	380	570	645		
Hispanic	Yes	12	13.917	23.008	6.6418	1	86	1	5	7.5	10	15	86	86	86		
Employment	*	16	18.813	43.196	10.799	1	180	1	5	7.5	12.5	15	180	180	180		
Employment	Full Time	110	55.827	136.782	13.0417	2	645	5	5	10	15	99	495	570	600		
Employment	Part Time	26	34.731	71.829	14.0868	3	355	5	5	10	25	100	130	355	355		
Employment	Not Employed	38	40.237	76.973	12.4867	4	380	5	5	10	20	140	240	380	380		
Employment	Refused	1	790	*	*	790	790	790	790	790	790	790	790	790	790		
Education	*	18	17.833	40.712	9.5958	1	180	1	5	7.5	15	15	180	180	180		
Education	< High School	16	103	164.12	41.03	5	520	5	10	15	140	365	520	520	520		
Education	High School Graduate	46	85.739	162.855	24.0116	3	645	5	5	10	85	380	495	645	645		
Education	< College	58	41.759	121.08	15.8986	2	790	4	5	13	20	60	110	510	790		
Education	College Graduate	30	36.633	111.641	20.3828	2	570	4	5	6.5	15	30	270	570	570		
Education	Post Graduate	23	10	6.396	1.3337	5	30	5	5	10	10	20	20	30	30		
Census Region	Northeast	33	59.697	149.173	25.9677	2	600	3	5	10	20	105	570	600	600		
Census Region	Midwest	48	28.563	77.552	11.1936	2	510	5	5	10	15	60	110	510	510		
Census Region	South	68	49.882	133.967	16.2459	1	790	5	5	10	15	130	295	645	790		
Census Region	West	42	69.786	135.545	20.9151	4	520	5	5	13	40	270	390	520	520		
Day Of Week	Weekday	122	58.402	145.085	13.1354	2	790	5	5	10	20	130	495	600	645		
Day Of Week	Weekend	69	36.797	79.004	9.5109	1	390	4	5	10	15	88	240	380	390		
Season	Winter	56	37.536	100.602	13.4435	2	600	4	5	10	15	60	270	355	600		
Season	Spring	54	80.13	157.514	21.4349	1	645	5	5	10	60	380	510	570	645		
Season	Summer	51	46.51	137.689	19.2804	2	790	5	5	10	15	35	365	520	790		
Season	Fall	30	28.767	58.93	10.7591	3	295	5	5	8.5	15	93	130	295	295		
Asthma	No	174	53.517	130.777	9.9141	1	790	5	5	10	20	130	380	570	645		
Asthma	Yes	16	15.75	25.736	6.434	2	110	2	5	7.5	15	20	110	110	110		
Asthma	DK	1	100	*	*	100	100	100	100	100	100	100	100	100	100		
Angina	No	184	46.788	120.622	8.8923	1	790	5	5	10	15	88	295	570	645		
Angina	Yes	7	150.714	206.81	78.1667	10	510	10	15	20	380	510	510	510	510		
Bronchitis/Emphysema	No	181	47.122	123.971	9.2147	1	790	5	5	10	15	85	295	570	645		
Bronchitis/Emphysema	Yes	10	113.5	142.946	45.2036	5	380	5	10	58	140	367.5	380	380	380		

Note: A "\*" Signifies missing data. "DK" = The respondent replied "don't know". Refused = Refused data. N = doer sample size. Mean = Mean 24-hour cumulative number of minutes for doers. Stdev = standard deviation. Stderr = standard error. Min = minimum number of minutes. Max = maximum number of minutes. Percentiles are the percentage of doers below or equal to a given number of minutes. Source: Tsang and Klepeis, 1996.



Table 15-107. Statistics for 24-Hour Cumulative Number of Minutes Spent Outdoors at a Construction Site

Group Name	Group Code	N	Mean	Stdev	Stderr	Min	Max	Percentiles									
								5	25	50	75	90	95	98	99		
All		143	437.098	242.073	20.243	1	1190	10	240	510	600	675	740	930	985		
Gender	Male	130	461.531	232.511	20.393	1	1190	10	300	522.5	600	688.5	745	930	985		
Gender	Female	13	192.769	202.794	56.245	5	630	5	60	135	165	535	630	630	630		
Age (years)	*	1	510	*	*	510	510	510	510	510	510	510	510	510	510		
Age (years)	1-4	2	240	254.558	180	60	420	60	60	240	420	420	420	420	420		
Age (years)	12-17	1	10	*	*	10	10	10	10	10	10	10	10	10	10		
Age (years)	18-64	133	444.549	243.017	21.072	1	1190	10	240	520	600	687	745	930	985		
Age (years)	> 64	6	396.667	188.75	77.057	60	560	60	300	460	540	560	560	560	560		
Race	White	125	430.872	247.432	22.131	5	1190	10	240	510	600	687	740	930	985		
Race	Black	10	430.1	233.307	73.778	1	630	1	170	550	585	615	630	630	630		
Race	Some Others	2	492.5	60.104	42.5	450	535	450	450	492.5	535	535	535	535	535		
Race	Hispanic	3	501.667	170.318	98.333	305	600	305	305	600	600	600	600	600	600		
Race	Refused	3	618.333	166.458	96.105	510	810	510	510	535	810	810	810	810	810		
Hispanic	No	129	426.202	247.087	21.755	1	1190	10	180	510	600	665	735	930	985		
Hispanic	Yes	9	496.111	166.429	55.476	240	765	240	410	505	600	765	765	765	765		
Hispanic	DK	2	577.5	180.312	127.5	450	705	450	450	577.5	705	705	705	705	705		
Hispanic	Refused	3	635	156.125	90.139	510	810	510	510	585	810	810	810	810	810		
Employment	*	3	163.333	223.681	129.142	10	420	10	10	60	420	420	420	420	420		
Employment	Full Time	127	456.803	236.198	20.959	1	1190	15	285	520	605	690	745	930	985		
Employment	Part Time	6	495.833	171.389	69.969	155	600	155	510	555	600	600	600	600	600		
Employment	Not Employed	7	146.571	162.79	61.529	5	430	5	6	60	300	430	430	430	430		
Education	*	4	250	251.794	125.897	10	510	10	35	240	465	510	510	510	510		
Education	< High School	12	500.833	227.035	65.539	60	930	60	375	525	592.5	735	930	930	930		
Education	High School Graduate	68	482.162	228.976	27.767	5	1190	20	395	522.5	592.5	720	780	985	1190		
Education	< College	41	417.683	241.023	37.641	1	745	10	170	520	615	645	687	745	745		
Education	College Graduate	14	372.357	247.278	66.088	15	660	15	120	440	585	643	660	660	660		
Education	Post Graduate	4	92.5	137.265	68.632	5	295	5	7.5	35	177.5	295	295	295	295		
Census Region	Northeast	28	481.714	238.306	45.036	5	985	6	357.5	532.5	650	695	740	985	985		
Census Region	Midwest	30	343.967	231.025	42.179	5	810	10	120	342	525	637.5	660	810	810		
Census Region	South	57	474.018	248.301	32.888	1	1190	10	410	535	615	720	765	780	1190		
Census Region	West	28	417.107	226.287	42.764	15	930	60	235	500	570	630	656	930	930		
Day Of Week	Weekday	121	455.116	238.494	21.681	5	1190	15	285	525	600	687	745	930	985		
Day Of Week	Weekend	22	338	243.022	51.813	1	705	5	60	407.5	525	600	645	705	705		
Season	Winter	34	418.5	268.44	46.037	1	1190	5	155	505	570	645	695	1190	1190		
Season	Spring	33	412.242	223.533	38.912	10	810	60	230	490	570	635	740	810	810		
Season	Summer	46	477.739	221.422	32.647	10	985	60	325	515	630	705	745	985	985		
Season	Fall	30	423.2	264.183	48.233	5	930	6	135	532.5	585	700	780	930	930		
Asthma	No	137	437.161	243.531	20.806	1	1190	10	240	510	600	675	745	930	985		
Asthma	Yes	6	435.667	225.957	92.247	60	690	60	354	440	630	690	690	690	690		
Angina	No	139	439.108	242.331	20.554	1	1190	10	240	510	600	687	745	930	985		
Angina	Yes	4	367.25	256.288	128.144	10	570	10	182	444.5	552.5	570	570	570	570		
Bronchitis/Emphysema	No	140	433.257	240.003	20.284	1	1190	10	240	510	600	670	737.5	810	930		
Bronchitis/Emphysema	Yes	3	616.333	328.664	189.755	354	985	354	354	510	985	985	985	985	985		

Note: A "\*" Signifies missing data. "DK" = The respondent replied "don't know". Refused = Refused data. N = doer sample size. Mean = Mean 24-hour cumulative number of minutes for doers. Stdev = standard deviation. Stderr = standard error. Min = minimum number of minutes. Max = maximum number of minutes. Percentiles are the percentage of doers below or equal to a given number of minutes.

Source: Tsang and Klepeis, 1996.



Table 15-108. Statistics for 24-Hour Cumulative Number of Minutes Spent Outdoors on School Grounds/Playground

Category	Population Group	N	Mean	Stdev	Stderr	Min	Max	Percentiles								
								5	25	50	75	90	95	98	99	
All		259	98.386	110.056	6.839	1	690	5	30	70	120	208	300	540	570	
Gender	Male	0.136	118.007	126.395	10.84	1	690	10	35	85	148.5	255	370	555	625	
Gender	Female	123	76.691	83.861	7.562	1	570	5	20	51	120	180	225	270	440	
Age (years)	*	2	275	374.767	265	10	540	10	10	275	540	540	540	540	540	
Age (years)	1-4	9	85	61.084	20.36	10	175	10	30	65	140	175	175	175	175	
Age (years)	5-11	64	88.016	95.638	11.96	5	625	10	30	60	120	170	220	315	625	
Age (years)	12-17	76	78.658	88.179	10.12	3	570	5	25	55	105	165	225	370	570	
Age (years)	18-64	101	119.812	127.563	12.69	1	690	5	30	85	165	240	360	540	555	
Age (years)	> 64	7	65	47.258	17.86	5	150	5	30	60	95	150	150	150	150	
Race	White	208	98.212	106.512	7.385	1	690	9	30	70	125	190	281	510	555	
Race	Black	23	128.435	157.54	32.85	5	570	5	25	67	170	300	540	570	570	
Race	Asian	6	59	66.076	26.98	10	179	10	10	35	85	179	179	179	179	
Race	Some Others	7	70	59.652	22.55	10	180	10	10	60	105	180	180	180	180	
Race	Hispanic	15	83.733	102.972	26.59	1	370	1	10	30	120	228	370	370	370	
Hispanic	No	225	102.613	113.686	7.579	3	690	9	30	70	125	210	300	540	570	
Hispanic	Yes	32	71.219	79.899	14.12	1	370	1	12.5	32.5	110	150	228	370	370	
Hispanic	DK	2	57.5	31.82	22.5	35	80	35	35	57.5	80	80	80	80	80	
Employment	*	143	80.161	88.031	7.362	3	625	9	25	55	115	160	215	315	570	
Employment	Full Time	48	130.271	127.162	18.35	1	555	10	40	85	180	300	360	555	555	
Employment	Part Time	24	129.708	158.934	32.44	3	690	10	35	85	143.5	228	510	690	690	
Employment	Not Employed	42	95.429	94.776	14.62	1	440	5	30	80	120	180	235	440	440	
Employment	Refused	2	322.5	307.591	217.5	105	540	105	105	323	540	540	540	540	540	
Education	*	162	86.593	94.553	7.429	3	625	10	27	60	120	170	220	370	570	
Education	< High School	11	124.818	171.918	51.84	1	540	1	5	45	180	345	540	540	540	
Education	High School Graduate	33	113.636	110.669	19.27	3	555	5	30	90	160	240	290	555	555	
Education	< College	19	129.842	147.389	33.81	5	510	5	33	70	210	440	510	510	510	
Education	College Graduate	19	122.105	149.938	34.4	5	690	5	50	85	125	235	690	690	690	
Education	Post Graduate	15	102.933	98.093	25.33	1	360	1	30	75	125	235	360	360	360	
Census Region	Northeast	66	105.955	115.248	14.19	5	690	10	30	85	150	190	281	540	690	
Census Region	Midwest	53	86.057	109.203	15	3	540	5	20	50	115	190	290	510	540	
Census Region	South	82	85.463	92.353	10.2	1	570	5	30	60	115	180	255	360	570	
Census Region	West	58	119.31	125.638	16.5	1	625	10	30	85	160	235	440	555	625	
Day Of Week	Weekday	205	87.02	105.524	7.37	1	625	5	25	55	115	180	240	540	555	
Day Of Week	Weekend	54	141.537	117.065	15.93	10	690	25	67	113	180	290	345	440	690	
Season	Winter	53	72.189	101.951	14	1	555	3	20	35	85	130	315	440	555	
Season	Spring	88	108.614	96.502	10.29	5	540	10	45	85	147.5	215	255	510	540	
Season	Summer	65	116.446	137.897	17.1	5	690	10	30	75	135	270	360	625	690	
Season	Fall	53	85.453	96.241	13.22	5	540	5	20	55	120	180	235	345	540	
Asthma	No	237	100.941	113.236	7.355	1	690	5	30	70	120	215	315	540	570	
Asthma	Yes	22	70.864	61.977	13.21	5	179	10	15	45	145	160	165	179	179	
Angina	No	254	99.118	110.809	6.953	1	690	5	30	68.5	120	208	300	540	570	
Angina	Yes	5	61.2	53.383	23.87	1	130	1	15	70	90	130	130	130	130	
Bronchitis/Emphysema	No	248	100.565	111.621	7.088	1	690	5	30	71	125	210	300	540	570	
Bronchitis/Emphysema	Yes	10	52.7	45.363	14.35	9	160	9	22	44	60	125	160	160	160	
Bronchitis/Emphysema	DK	1	15	0	0	15	15	15	15	15	15	15	15	15	15	

Note: A "\*" Signifies missing data. "DK" = The respondent replied "don't know". Refused = Refused data. N = doer sample size. Mean = Mean 24-hour cumulative number of minutes for doers. Stdev = standard deviation. Stderr = standard error. Min = minimum number of minutes. Max = maximum number of minutes. Percentiles are the percentage of doers below or equal to a given number of minutes. Source: Tsang and Klepeis, 1996.



Table 15-109. Statistics for 24-Hour Cumulative Number of Minutes Spent Outdoors at a Park/Golf Course

Category	Population Group	N	Mean	Stdev	Stderr	Min	Max	Percentiles									
								5	25	50	75	90	95	98	99		
All		506	198.603	190.248	8.4575	1	1065	20	60	135	270	465	590	748	870		
Gender	Male	291	205.825	183.101	10.7336	1	1015	25	60	150	285	510	590	730	755		
Gender	Female	214	187.748	199.367	13.6284	5	1065	15	55	120	250	435	590	870	930		
Gender	Refused	1	420	*	*	420	420	420	420	420	420	420	420	420	420		
Age (years)	*	10	122.4	60.183	19.0317	30	225	30	60	120	160	202	225	225	225		
Age (years)	1-4	21	149.857	176.25	38.4609	21	755	25	50	85	150	360	425	755	755		
Age (years)	5-11	54	207.556	184.496	25.1068	25	665	35	70	125	275	555	635	660	665		
Age (years)	12-17	52	238.462	242.198	33.5869	15	1065	15	60	147.5	337.5	590	840	915	1065		
Age (years)	18-64	314	197.838	185.939	10.4931	1	1015	20	60	150	270	440	580	748	870		
Age (years)	> 64	55	188.964	182.919	24.6648	10	735	20	30	120	300	510	570	590	735		
Race	White	441	205.338	195.266	9.2984	1	1065	20	60	150	275	480	605	795	915		
Race	Black	19	114.474	103.667	23.7829	15	425	15	30	90	155	240	425	425	425		
Race	Asian	8	185.625	233.398	82.5186	30	665	30	32.5	47.5	315	665	665	665	665		
Race	Some Others	16	171.25	154.229	38.5572	30	560	30	58	119.5	235	405	560	560	560		
Race	Hispanic	20	169.45	135.803	30.3664	30	555	32.5	77	145	205	372.5	495	555	555		
Race	Refused	2	75	63.64	45	30	120	30	30	75	120	120	120	120	120		
Hispanic	No	469	202.706	193.555	8.9376	1	1065	20	60	135	270	480	605	755	915		
Hispanic	Yes	34	154.824	135.043	23.1596	15	555	30	60	137.5	175	310	555	555	555		
Hispanic	DK	1	10	*	*	10	10	10	10	10	10	10	10	10	10		
Hispanic	Refused	2	75	63.64	45	30	120	30	30	75	120	120	120	120	120		
Employment	*	128	208.242	209.644	18.5301	15	1065	25	60	120	275	555	645	840	915		
Employment	Full Time	201	195.831	188.984	13.3299	8	1015	25	60	135	270	450	570	748	930		
Employment	Part Time	41	213.488	215.602	33.6714	20	870	20	60	132	260	540	660	870	870		
Employment	Not Employed	132	190.932	166.019	14.4501	1	810	15	60	160	270	420	525	730	735		
Employment	Refused	4	130	106.771	53.3854	30	280	30	60	105	200	280	280	280	280		
Education	*	140	202.743	204.676	17.2983	15	1065	20.5	60	120	270	498.5	640	840	915		
Education	< High School	32	180.844	207.784	36.7315	30	995	30	30	110	245	385	570	995	995		
Education	High School Graduate	108	219.676	197.223	18.9778	10	1015	20	77.5	162.5	281	545	625	730	810		
Education	<College	93	191.57	171.177	17.7502	1	870	15	60	150	275	440	510	748	870		
Education	College Graduate	83	203.53	183.095	20.0973	5	930	23	60	145	270	450	590	795	930		
Education	Post Graduate	50	157.76	166.568	23.5562	10	735	20	45	75	255	337.5	555	703	735		
Census Region	Northeast	106	184.858	177.429	17.2334	1	1065	20	60	124	240	450	574	635	660		
Census Region	Midwest	124	194.629	188.667	16.9428	10	1015	30	60	135	255	420	590	735	995		
Census Region	South	136	218.846	211.474	18.1337	10	930	20	60	150	325	525	720	840	915		
Census Region	West	140	192.864	179.421	15.1639	5	870	17.5	58	131	272.5	430	575	755	810		
Day Of Week	Weekday	276	195.996	189.287	11.3938	5	1015	20	60	145	252.5	510	625	748	840		
Day Of Week	Weekend	230	201.73	191.76	12.6443	1	1065	20	60	130	280	454.5	580	810	915		
Season	Winter	83	209.072	195.228	21.429	15	1065	30	60	165	275	440	660	795	1065		
Season	Spring	163	168.479	159.071	12.4594	8	930	20	50	120	235	360	510	570	755		
Season	Summer	192	219.615	199.872	14.4245	5	1015	20	65	155	290	535	630	840	915		
Season	Fall	68	198.706	217.911	26.4256	1	995	20	60	117.5	280	555	735	810	995		
Asthma	No	466	192.127	178.759	8.2808	1	1015	20	60	135	270	450	580	700	755		
Asthma	Yes	38	284.526	288.727	46.8377	30	1065	35	90	170	390	870	995	1	65		
Asthma	DK	2	75	63.64	45	30	120	30	30	75	120	120	120	120	120		
Angina	No	494	197.881	189.761	8.5378	1	1065	20	60	135	270	459	590	755	915		
Angina	Yes	9	247.778	235.267	78.4224	35	730	35	60	120	330	730	730	730	730		
Angina	DK	3	170	170.587	98.4886	30	360	30	30	120	360	360	360	360	360		
Bronchitis/Emphysema	No	490	196.978	184.633	8.3409	1	1065	20	60	145	270	454.5	585	735	840		
Bronchitis/Emphysema	Yes	14	273.143	339.073	90.6211	20	995	20	75	100	280	930	995	995	995		
Bronchitis/Emphysema	DK	2	75	63.64	45	30	120	30	30	75	120	120	120	120	120		

Note: A "\*" Signifies missing data. "DK" = The respondent replied "don't know". Refused = Refused data. N = doer sample size. Mean = Mean 24-hour cumulative number of minutes for doers. Stdev = standard deviation. Stderr = standard error. Min = minimum number of minutes. Max = maximum number of minutes. Percentiles are the percentage of doers below or equal to a given number of minutes.  
Source: Tsang and Klepeis, 1996.



Table 15-110. Statistics for 24-Hour Cumulative Number of Minutes Spent Outdoors at a Pool/River/Lake

Category	Population Group	N	Mean	Stdev	Stdev	Min	Max	Percentiles								
								5	25	50	75	90	95	98	99	
All		283	209.555	185.668	11.037	5	1440	25	60	150	296	480	570	670	690	
Gender	Male	152	229.829	202.702	16.441	10	1440	30	82.5	174	305	510	600	690	900	
Gender	Female	131	186.031	161.293	14.092	5	645	20	60	135	280	440	550	630	630	
Age (years)	*	6	175	156.971	64.083	60	480	60	85	115	195	480	480	480	480	
Age (years)	1-4	14	250.571	177.508	47.441	90	630	90	130	167.5	370	560	630	630	630	
Age (years)	5-11	29	175.448	117.875	21.889	25	390	30	60	145	293	365	375	390	390	
Age (years)	12-17	22	128.318	94.389	20.124	40	420	58	60	82.5	210	225	235	420	420	
Age (years)	18-64	187	224.492	203.822	14.905	5	1440	20	60	150	320	511	615	690	900	
Age (years)	> 64	25	194.2	161.757	32.351	20	525	30	60	115	277	480	510	525	525	
Race	White	246	201.565	182.298	11.623	5	1440	25	60	145	285	440	560	670	690	
Race	Black	12	380.583	231.89	66.941	20	690	20	177.5	450	562.5	615	690	690	690	
Race	Asian	4	265	247.083	123.54	30	505	30	52.5	262.5	477.5	505	505	505	505	
Race	Some Others	5	237	129.933	58.108	70	435	70	220	225	235	435	435	435	435	
Race	Hispanic	12	161	131.699	38.018	20	390	20	52.5	112.5	265	375	390	390	390	
Race	Refused	4	243.75	208.621	104.31	90	550	90	115	167.5	372.5	550	550	550	550	
Hispanic	No	259	208.923	187.792	11.669	5	1440	25	60	150	295	480	585	670	690	
Hispanic	Yes	20	210.9	160.142	35.809	20	540	28.5	87.5	155	337.5	450.5	525.5	540	540	
Hispanic	Refused	4	243.75	208.621	104.31	90	550	90	115	167.5	372.5	550	550	550	550	
Employment	*	66	176.879	131.256	16.156	25	630	40	70	142.5	235	370	420	560	630	
Employment	Full Time	119	210.748	176.089	16.142	10	900	20	65	150	298	510	600	645	670	
Employment	Part Time	26	217.038	199.926	39.209	20	670	30	60	120	320	570	580	670	670	
Employment	Not Employed	69	238.884	236.16	28.43	5	1440	20	65	145	370	510	630	690	1440	
Employment	Refused	3	141.667	52.52	30.322	90	195	90	90	140	195	195	195	195	195	
Education	*	73	172.932	129.988	15.214	20	630	30	70	140	225	370	420	560	630	
Education	< High School	18	267.611	159.382	37.567	40	600	40	145	247.5	375	525	600	600	600	
Education	High School Graduate	69	213.217	224.126	26.982	10	1440	20	60	145	285	511	670	690	1440	
Education	< College	62	233.258	192.408	24.436	5	690	30	65	150	360	550	580	615	690	
Education	College Graduate	37	230.919	187.271	30.787	14	645	20	70	173	400	505	630	645	645	
Education	Post Graduate	24	172.708	196.977	40.208	20	900	25	45	112.5	240	370	480	900	900	
Census Region	Northeast	61	220.689	172.373	22.07	30	900	30	60	180	325	390	510	670	900	
Census Region	Midwest	41	219.22	257.201	40.168	10	1440	20	60	120	280	480	600	1440	1440	
Census Region	South	111	182.198	161.288	15.309	5	670	20	60	118	280	420	525	630	645	
Census Region	West	70	237.571	181.838	21.734	25	690	40	90	180	300	547.5	615	690	690	
Day Of Week	Weekday	165	188.77	179.894	14.005	10	1440	30	60	125	255	420	511	615	670	
Day Of Week	Weekend	118	238.619	190.432	17.531	5	900	20	75	187.5	350	555	630	690	690	
Season	Winter	30	173.167	181.68	33.17	20	630	20	40	102.5	270	492.5	585	630	630	
Season	Spring	77	206.468	163.551	18.638	15	690	30	80	180	288	480	555	670	690	
Season	Summer	151	219.709	196.809	16.016	5	1440	26	65	155	300	445	580	630	900	
Season	Fall	25	201.4	189.663	37.933	20	670	45	70	105	310	510	510	670	670	
Asthma	No	262	209.004	188.208	11.628	5	1440	25	60	150	295	480	580	670	690	
Asthma	Yes	17	238.824	161.966	39.282	15	570	15	105	225	350	525	570	570	570	
Asthma	DK	4	121.25	59.214	29.607	60	195	60	75	115	167.5	195	195	195	195	
Angina	No	272	205.897	185.199	11.229	5	1440	25	60	145	290.5	480	570	645	690	
Angina	Yes	8	359.375	178.774	63.206	60	690	60	287.5	340	435	690	690	690	690	
Angina	DK	3	141.667	52.52	30.322	90	195	90	90	140	195	195	195	195	195	
Bronchitis/Emphysema	No	266	210.974	189.082	11.593	5	1440	25	60	150	296	480	580	670	690	
Bronchitis/Emphysema	Yes	14	197.143	131.54	35.156	15	440	15	90	172.5	300	370	440	440	440	
Bronchitis/Emphysema	DK	3	141.667	52.52	30.322	90	195	90	90	140	195	195	195	195	195	

Note: A "\*" Signifies missing data. "DK" = The respondent replied "don't know". Refused = Refused data. N = doer sample size. Mean = Mean 24-hour cumulative number of minutes for doers. Stdev = standard deviation. Stdevr = standard error. Min = minimum number of minutes. Max = maximum number of minutes. Percentiles are the percentage of doers below or equal to a given number of minutes.

Source: Tsang and Klepeis, 1996.





Table 15-111. Statistics for 24-Hour Cumulative Number of Minutes Spent Outdoors at a Restaurant/Picnic

Category	Population Group	N	Mean	Stdev	Stderr	Min	Max	Percentiles							
								5	25	50	75	90	95	98	99
All		64	81.016	114.7	14.337	3	540	5	12.5	30	107.5	165	270	540	540
Gender	Male	31	111.839	148.921	26.747	5	540	5	20	60	150	270	540	540	540
Gender	Female	33	52.061	57.66	10.037	3	210	3	8	30	80	135	180	210	210
Age (years)	1-4	6	57.5	61.38	25.058	5	160	5	15	30	105	160	160	160	160
Age (years)	5-11	5	112.8	202.59	90.601	5	473	5	6	20	60	473	473	473	473
Age (years)	12-17	6	60	55.408	22.62	5	150	5	30	35	105	150	150	150	150
Age (years)	18-64	46	84.804	116.85	17.229	3	540	5	10	50	120	180	270	540	540
Age (years)	> 64	1	15	*	*	15	15	15	15	15	15	15	15	15	15
Race	White	54	76	105.032	14.293	3	540	5	15	30	105	165	270	473	540
Race	Black	4	57.75	83.108	41.554	5	180	5	5.5	23	110	180	180	180	180
Race	Asian	1	75	*	*	75	75	75	75	75	75	75	75	75	75
Race	Some Others	2	97.5	31.82	22.5	75	120	75	75	97.5	120	120	120	120	120
Race	Hispanic	2	20	14.142	10	10	30	10	10	20	30	30	30	30	30
Race	Refused	1	540	*	*	540	540	540	540	540	540	540	540	540	540
Hispanic	No	60	81.833	117.521	15.172	3	540	5	12.5	30	107.5	172.5	371.5	540	540
Hispanic	Yes	4	68.75	66.63	33.315	10	160	10	20	52.5	117.5	160	160	160	160
Employment	*	17	74.647	114.206	27.699	5	473	5	15	30	105	160	473	473	473
Employment	Full Time	37	70.838	67.86	11.156	3	270	5	15	55	120	165	210	270	270
Employment	Part Time	4	42	32.031	16.016	3	75	3	16.5	45	67.5	75	75	75	75
Employment	Not Employed	6	187.833	272.841	111.387	5	540	5	7	17.5	540	540	540	540	540
Education	*	18	70.667	112.076	26.416	3	473	3	6	30	105	160	473	473	473
Education	< High School	1	540	*	*	540	540	540	540	540	540	540	540	540	540
Education	High School Graduate	11	56.182	84.536	25.489	3	270	3	10	20	60	165	270	270	270
Education	< College	10	108.6	164.611	52.055	5	540	5	7	30	150	352.5	540	540	540
Education	College Graduate	11	68.636	59.544	17.953	10	210	10	20	55	110	120	210	210	210
Education	Post Graduate	13	70.308	53.494	14.836	6	180	6	15	75	80	140	180	180	180
Census Region	Northeast	19	88.105	116.181	26.654	3	473	3	10	60	120	270	473	473	473
Census Region	Midwest	15	102.6	140.685	36.325	3	540	3	15	45	165	210	540	540	540
Census Region	South	16	48.563	47.25	11.812	5	140	5	8.5	30	92.5	120	140	140	140
Census Region	West	14	85.357	138.737	37.079	10	540	10	15	30	75	160	540	540	540
Day Of Week	Weekday	35	51.2	52.665	8.902	3	180	3	15	30	75	150	165	180	180
Day Of Week	Weekend	29	117	154.21	28.636	5	540	5	10	60	135	473	540	540	540
Season	Winter	8	79.375	75.187	26.583	10	210	10	20	52.5	135	210	210	210	210
Season	Spring	14	138.429	172.811	46.186	5	540	5	30	65	180	473	540	540	540
Season	Summer	28	71	105.063	19.855	3	540	3	7.5	35	100	150	160	540	540
Season	Fall	14	44.571	52.2	13.951	5	165	5	10	20	60	150	165	165	165
Asthma	No	61	82.131	117.182	15.004	3	540	5	10	30	110	165	270	540	540
Asthma	Yes	3	58.333	40.723	23.511	30	105	30	30	40	105	105	105	105	105
Angina	No	63	82.222	115.211	14.515	3	540	5	15	30	110	165	270	540	540
Angina	Yes	1	5	*	*	5	5	5	5	5	5	5	5	5	5
Bronchitis/Emphysema	No	63	81.667	115.502	14.552	3	540	5	10	30	110	165	270	540	540
Bronchitis/Emphysema	Yes	1	40	*	*	40	40	40	40	40	40	40	40	40	40

Note: A "\*" Signifies missing data. Refused = Refused data. N = doer sample size. Mean = Mean 24-hour cumulative number of minutes for doers. Stdev = standard deviation. Stderr = standard error. Min = minimum number of minutes. Max = maximum number of minutes. Percentiles are the percentage of doers below or equal to a given number of minutes.  
Source: Tsang and Klepeis, 1996.



Table 15-112. Statistics for 24-Hour Cumulative Number of Minutes Spent Outdoors at a Farm

Category	Population Group	N	Mean	Stdev	Stderr	Min	Max	Percentiles									
								5	25	50	75	90	95	98	99		
All		128	252.703	232.537	20.554	5	955	20	75	176.5	427.5	600	730	855	933		
Gender	Male	86	305.186	251.432	27.113	5	955	29	90	230	500	660	780	933	955		
Gender	Female	42	145.238	137.207	21.171	5	600	20	50	105	210	265	482	600	600		
Age (years)	*	1	510	*	*	510	510	510	510	510	510	510	510	510	510		
Age (years)	1-4	3	121.667	52.52	30.322	70	175	70	70	120	175	175	175	175	175		
Age (years)	5-11	7	111.286	76.952	29.085	25	264	25	50	100	130	264	264	264	264		
Age (years)	12-17	9	157.778	85.416	28.472	29	265	29	90	175	265	265	265	256	265		
Age (years)	18-64	91	296.67	252.209	26.439	5	955	20	80	230	500	635	780	933	955		
Age (years)	> 64	17	133.824	134.182	32.544	5	495	5	50	85	160	360	495	495	495		
Race	White	120	260.217	236.226	21.564	5	955	20	75	180	472.5	607.5	745	855	933		
Race	Black	4	58.75	30.923	15.462	25	85	25	32.5	62.5	85	85	85	85	85		
Race	Some Others	2	165	21.213	15	150	180	150	150	165	180	180	180	180	180		
Race	Hispanic	2	277.5	222.739	157.5	120	435	120	120	277.5	435	435	435	435	435		
Hispanic	No	123	252.61	234.762	21.168	5	955	20	70	178	420	600	730	855	933		
Hispanic	Yes	4	297.5	189.143	94.571	120	485	120	135	292.5	460	485	485	485	485		
Hispanic	Refused	1	85	*	*	85	85	85	85	85	85	85	85	85	85		
Employment	*	19	134.947	77.658	17.816	25	265	25	86	120	180	264	265	265	265		
Employment	Full Time	73	314.781	258.07	30.205	5	955	20	85	240	525	660	780	933	955		
Employment	Part Time	11	283	183.589	55.354	45	525	45	150	230	490	495	525	525	525		
Employment	Not Employed	24	152.917	183.977	37.554	5	825	5	35	90	205	280	495	825	825		
Employment	Refused	1	20	*	*	20	20	20	20	20	20	20	20	20	20		
Education	*	20	137.2	76.255	17.051	25	265	27	88	120	180	262	264.5	265	265		
Education	< High School	12	305	211.058	60.927	30	635	30	97.5	325	492.5	510	635	635	635		
Education	High School Graduate	50	314.54	280.31	39.642	5	955	20	85	215	525	745	855	944	955		
Education	< College	25	186.6	165.994	33.199	5	555	15	60	155	255	482	525	555	555		
Education	College Graduate	12	290.417	242.903	70.12	30	615	30	67.5	202.5	530	600	615	615	615		
Education	Post Graduate	9	229.444	246.062	82.021	5	780	5	80	150	210	780	780	780	780		
Census Region	Northeast	11	238.182	299.143	90.195	5	955	5	30	100	490	520	955	955	955		
Census Region	Midwest	42	202.31	196.644	30.343	15	780	20	654	125	265	510	635	780	780		
Census Region	South	57	279.702	239.345	31.702	5	933	25	85	195	482	635	760	825	933		
Census Region	West	18	293.667	242.324	57.116	5	855	5	120	220	525	615	855	855	855		
Day Of Week	Weekday	78	276.859	243.801	27.605	5	955	15	85	180	485	615	780	933	955		
Day Of Week	Weekend	50	215.02	210.635	29.788	5	855	25	60	120	290	525	700	792.5	855		
Season	Winter	32	205.25	207.666	36.711	5	955	22	77.5	120	245	495	540	955	955		
Season	Spring	40	224.4	213.304	33.726	5	825	25	60	152.5	342.5	525	625	825	825		
Season	Summer	43	276.093	247.758	37.783	5	933	20	70	230	435	660	760	933	933		
Season	Fall	13	379.231	264.904	73.471	15	780	15	200	280	600	730	780	780	780		
Asthma	No	120	256.983	235.209	21.472	5	955	21	75	180	427.5	607.5	745	855	933		
Asthma	Yes	8	188.5	188.481	66.638	5	500	5	700	110	321.5	500	500	500	500		
Angina	No	127	253.039	233.426	20.713	5	955	20	75	175	435	600	730	855	933		
Angina	Yes	1	210	*	*	210	210	210	210	210	210	210	210	210	210		
Bronchitis/Emphysema	No	125	256.208	233.892	20.92	5	955	22	75	178	435	600	730	855	933		
Bronchitis/Emphysema	Yes	3	106.667	95.699	55.252	5	195	5	5	120	195	195	195	195	195		

Note: A "\*" Signifies missing data. Refused = Refused data. N = doer sample size. Mean = Mean 24-hour cumulative number of minutes for doers. Stdev = standard deviation. Stderr = standard error. Min = minimum number of minutes. Max = maximum number of minutes. Percentiles are the percentage of doers below or equal to a given number of minutes.  
Source: Tsang and Klepeis, 1996.



Table 15-113. Statistics for 24-Hour Cumulative Number of Minutes Spent at Home in the Kitchen

Category	Population Group	N	Mean	Stdev	Stderr	Min	Max	Percentiles							
								5	25	50	75	90	95	98	99
All		7063	92.646	94.207	1.121	1	1320	10	30	60	120	205	270	365	460
Gender	Male	2988	74.998	80.79	1.478	1	840	10	30	55	90	155	215	300	392
Gender	Female	4072	105.636	101.03	1.5832	1	1320	10	35	75	145	230	295	395	475
Gender	Refused	3	40	31.225	18.028	15	75	15	15	30	75	75	75	75	75
Age (years)	*	144	102.688	110.82	9.235	5	840	15	30	70	130	215	260	485	540
Age (years)	1-4	335	73.719	54.382	2.9712	5	392	15	30	60	100	140	180	225	240
Age (years)	5-11	477	60.468	52.988	2.4262	1	690	10	30	50	75	120	150	180	235
Age (years)	12-17	396	55.02	58.111	2.9202	1	450	5	15	36	65	125	155	240	340
Age (years)	18-64	4531	90.313	90.893	1.3503	1	1320	10	30	60	120	200	260	345	420
Age (years)	> 64	1180	131.388	119.55	3.4802	3	825	15	49	100	172	275	360	490	620
Race	White	5827	95.076	95.151	1.2465	1	840	10	30	65	120	210	273	380	465
Race	Black	641	79.376	91.989	3.6333	2	1320	10	30	60	100	175	230	275	380
Race	Asian	113	89.363	95.45	8.9792	5	690	10	30	75	115	150	220	265	650
Race	Some Others	119	69.059	60.786	5.5722	2	315	7	30	55	90	150	195	210	315
Race	Hispanic	266	84.203	77.297	4.7394	1	585	10	30	60	110	190	240	305	360
Race	Refused	97	90.33	113.55	11.53	5	880	7	30	60	90	190	275	480	880
Hispanic	No	6458	93.422	94.778	1.1794	1	1320	10	30	60	120	210	270	370	460
Hispanic	Yes	497	83.889	82.921	3.7195	1	675	10	30	60	110	180	240	315	415
Hispanic	DK	32	82.25	71.901	12.71	5	300	10	35	60	112.5	185	240	300	300
Hispanic	Refused	76	88.421	118.56	13.6	5	880	7	30	60	90	190	240	480	880
Employment	*	1200	62.348	55.431	1.6001	1	690	10	30	50	85	125	152.5	212.5	260
Employment	Full Time	2965	77.748	77.466	1.4227	1	840	10	30	60	100	165	225	300	376
Employment	Part Time	608	97.699	94.046	3.8141	1	755	10	30	70	133.5	213	270	405	445
Employment	Not Employed	2239	126.929	115.78	2.4468	1	1320	12	45	95	175	270	342	470	545
Employment	Refused	51	106.373	168.46	23.589	2	880	5	30	48	130	210	250	840	880
Education	*	1346	63.922	62.315	1.6985	1	880	10	30	50	85	130	165	235	285
Education	< High School	678	108.114	102.88	3.9511	1	775	10	34	80	150	230	295	405	545
Education	High School Graduate	2043	107.208	102.33	2.264	1	840	10	35	75	150	235	300	415	500
Education	< College	1348	94.359	101.17	2.7555	1	1320	10	30	60	120	210	280	380	450
Education	College Graduate	933	91.874	92.098	3.0152	2	840	10	30	60	120	200	261	330	410
Education	Post Graduate	715	88.227	87.661	3.2783	1	770	10	30	60	113	190	260	380	405
Census Region	Northeast	1645	99.632	99.739	2.4591	1	840	10	30	70	130	210	300	390	465
Census Region	Midwest	1601	96.066	93.567	2.3384	1	833	10	30	65	125	213	270	355	450
Census Region	South	2383	86.253	87.055	1.7833	1	880	10	30	60	115	190	245	330	420
Census Region	West	1434	91.441	99.061	2.6159	1	1320	10	30	60	119	195	255	380	480
Day Of Week	Weekday	4849	90.068	92.218	1.3243	1	1320	10	30	60	119	195	255	360	450
Day Of Week	Weekend	2214	98.294	98.207	2.0871	1	840	10	30	65.5	135	220	280	390	480
Season	Winter	1938	96.575	100.32	2.2787	1	1320	10	30	65	120	210	285	390	485
Season	Spring	1780	89.02	90.187	2.1376	1	840	10	30	60	120	195	255	350	420
Season	Summer	1890	89.316	90.984	2.0928	1	880	10	30	60	120	195	255	362	430
Season	Fall	1455	96.177	94.494	2.4773	1	770	10	30	65	125	210	275	375	470
Asthma	No	6510	92.448	93.602	1.1601	1	1320	10	30	60	120	205	270	365	450
Asthma	Yes	503	94.038	96.001	4.2805	1	785	10	30	60	120	210	270	345	450
Asthma	DK	50	104.44	143.73	20.326	7	880	10	30	60	120	195	240	712.5	880
Angina	No	6798	91.625	93.03	1.1283	1	1320	10	30	60	120	200	265	360	450
Angina	Yes	207	122.469	111.41	7.7437	4	657	10	45	100	155	255	360	415	620
Angina	DK	58	105.948	138.38	18.17	2	880	10	30	60	135	240	240	545	880
Bronchitis/Emphysema	No	6671	91.827	92.587	1.1336	1	1320	10	30	60	120	200	265	360	445
Bronchitis/Emphysema	Yes	338	104.784	113.39	6.1676	1	825	10	30	71	135	225	300	480	657
Bronchitis/Emphysema	DK	54	117.889	142.41	19.38	2	880	10	30	76	160	240	275	545	880

Note: A "\*" Signifies missing data. "DK" = The respondent replied "don't know". Refused = Refused data. N = doer sample size. Mean = Mean 24-hour cumulative number of minutes for doers. Stdev = standard deviation. Stderr = standard error. Min = minimum number of minutes. Max = maximum number of minutes. Percentiles are the percentage of doers below or equal to a given number of minutes.

Source: Tsang and Klepeis, 1996.



Table 15-114. Statistics for 24-Hour Cumulative Number of Minutes Spent in the Bathroom

Category	Population Group	N	Mean	Stdev	Stderr	Min	Max	Percentiles							
								5	25	50	75	90	95	98	99
All		6661	35.0237	48.796	0.5979	1	870	5	15	25	40	60	90	137	255
Gender	Male	3006	32.689	50.366	0.9186	1	870	5	15	20.5	35	60	75	150	300
Gender	Female	3653	36.9491	47.399	0.7842	1	665	5	15	30	45	70	90	135	240
Gender	Refused	2	27.5	3.536	2.5	25	30	25	25	27.5	30	30	30	30	30
Age (years)	*	122	43.8689	67.007	6.0665	2	530	5	15	30	45	85	120	300	360
Age (years)	1-4	328	35.939	46.499	2.5675	1	600	10	15	30	40	60	75	125	270
Age (years)	5-11	490	30.9673	38.609	1.7442	1	535	5	15	27	35	52.5	60	100	200
Age (years)	12-17	445	29.0517	32.934	1.5612	1	547	5	15	20	35	60	65	90	100
Age (years)	18-64	4486	34.4884	46.067	0.6878	1	665	5	15	25	40	60	90	135	250
Age (years)	> 64	790	42.1975	69.431	2.4703	1	870	5	15	30	45	75	120	240	360
Race	White	5338	34.3164	48.628	0.6656	1	870	5	15	25	40	60	85	135	255
Race	Black	711	36.8678	39.559	1.4836	1	460	5	15	30	45	70	98	135	186
Race	Asian	117	33.5556	41.449	3.8319	5	375	5	15	25	40	60	90	110	210
Race	Some Others	134	47.306	69.649	6.0167	1	535	5	15	30	45	95	120	315	422
Race	Hispanic	283	38.6396	61.494	3.6554	1	546	5	15	24	45	60	80	270	425
Race	Refused	78	34.6026	49.182	5.5687	3	360	5	10	20	35	60	135	165	360
Hispanic	No	6067	34.5332	45.887	0.5891	1	705	5	15	25	40	60	90	135	240
Hispanic	Yes	498	39.2309	68.582	3.0733	1	870	5	15	25	45	60	90	270	425
Hispanic	DK	33	44.4242	72.269	12.58	5	422	10	15	30	45	60	120	422	422
Hispanic	Refused	63	44.0794	95.224	11.997	3	665	5	10	20	35	60	150	360	665
Employment	*	1240	31.9645	39.652	1.1261	1	600	5	15	30	35	60	70	100	180
Employment	Full Time	3130	33.4086	44.827	0.8012	1	595	5	15	25	40	60	80	123	240
Employment	Part Time	583	35.5232	43.932	1.8195	1	430	5	15	29	45	60	90	140	270
Employment	Not Employed	1661	40.1854	61.587	1.5111	1	870	5	15	30	45	75	110	210	340
Employment	Refused	47	34.6809	54.835	7.9986	3	360	5	15	25	30	55	75	360	360
Education	*	1386	32.1717	42.788	1.1493	1	665	5	15	25	35	60	70	110	200
Education	< High School	522	40.8736	64.533	2.8245	1	870	5	15	30	45	70	100	240	350
Education	High School Graduate	1857	35.832	50.155	1.1639	1	600	5	15	25	40	63	90	135	270
Education	< College	1305	36.0797	44.121	1.2214	1	540	5	15	25	45	70	95	150	225
Education	College Graduate	913	34.9912	54.071	1.7895	1	705	5	15	20	40	60	90	150	340
Education	Post Graduate	678	32.1475	42.82	1.6445	1	460	5	15	22	40	60	75	110	300
Census Region	Northeast	1497	34.3287	51.244	1.3244	1	600	5	15	25	40	60	80	140	335
Census Region	Midwest	1465	35.7802	54.521	1.4245	1	870	5	15	25	40	60	90	145	315
Census Region	South	2340	35.0739	42.003	0.8683	1	510	5	15	30	40	60	90	135	214
Census Region	West	1359	34.8874	50.399	1.3671	1	705	5	15	25	40	60	90	140	250
Day Of Week	Weekday	4613	33.9035	46.663	0.687	1	870	5	15	25	40	60	85	135	240
Day Of Week	Weekend	2048	37.5469	53.214	1.1759	1	600	5	15	30	45	65	90	150	300
Season	Winter	1853	37.0232	50.658	1.1768	1	665	5	15	30	42	65	90	150	270
Season	Spring	1747	36.6474	50.536	1.2091	1	870	5	15	30	45	60	90	135	240
Season	Summer	1772	32.7788	44.543	1.0582	1	570	5	15	25	38	60	80	135	210
Season	Fall	1289	33.0349	49.108	1.3678	1	540	5	11	20	35	60	90	140	303
Asthma	No	6132	34.9204	48.833	0.6236	1	870	5	15	25	40	60	90	135	255
Asthma	Yes	493	35.2495	38.157	1.7185	1	410	5	15	30	45	65	90	140	220
Asthma	DK	36	49.5278	121.114	20.186	3	665	5	10	17.5	30	60	360	665	665
Angina	No	6473	34.5801	46.79	0.5816	1	870	5	15	25	40	60	90	135	240
Angina	Yes	145	51.9103	88.284	7.3316	3	600	7	20	30	45	75	185	546	570
Angina	DK	43	44.8605	111.216	16.96	3	665	5	10	15	30	50	110	665	665
Bronchitis/Emphysema	No	6327	34.8211	48.073	0.6044	1	870	5	15	25	40	60	90	135	255
Bronchitis/Emphysema	Yes	296	36.8378	47.481	2.7598	1	600	5	15	30	43.5	60	90	180	250
Bronchitis/Emphysema	DK	38	54.6316	122.723	19.908	3	665	5	10	17.5	30	110	360	665	665

Note: A "\*" Signifies missing data. "DK" = The respondent replied "don't know". Refused = Refused data. N = doer sample size. Mean = Mean 24-hour cumulative number of minutes for doers. Stdev = standard deviation. Stderr = standard error. Min = minimum number of minutes. Max = maximum number of minutes. Percentiles are the percentage of doers below or equal to a given number of minutes. Source: Tsang and Klepeis, 1996.



Table 15-115. Statistics for 24-Hour Cumulative Number of Minutes Spent at Home in the Bedroom

Category	Population Group	N	Mean	Stdev	Stderr	Min	Max	Percentiles							
								5	25	50	75	90	95	98	99
All		9151	563.12	184.644	1.9302	3	1440	300	460	540	660	780	880	1005	1141
Gender	Male	4157	549.648	182.976	2.8379	3	1440	285	450	540	640	780	860	980	1095
Gender	Female	4990	574.274	185.332	2.6236	5	1440	312	470	555	660	790	900	1030	1185
Gender	Refused	4	648.75	122.772	61.386	540	785	540	545	635	752.5	785	785	785	785
Age (years)	*	184	525.065	193.498	14.265	15	1440	195	420	513	600	720	860	950	1295
Age (years)	1-4	488	741.988	167.051	7.562	30	1440	489	635	740	840	930	990	1095	1200
Age (years)	5-11	689	669.144	162.888	6.2055	35	1440	435	600	665	740	840	915	1065	1140
Age (years)	12-17	577	636.189	210.883	8.7792	15	1375	165	542	645	750	875	970	1040	1210
Age (years)	18-64	5891	532.699	172.964	2.2535	3	1440	295	440	520	610	723	820	975	1110
Age (years)	> 64	1322	550.8	171.997	4.7305	15	1440	315	475	540	610	735	840	1000	1140
Race	White	7403	553.424	175.912	2.0445	3	1440	300	455	540	640	760	850	975	1105
Race	Black	923	612.33	219.9	7.2381	15	1440	300	480	597	725	895	990	1160	1323
Race	Asian	153	612.261	187.417	15.152	25	1285	345	510	600	705	830	950	1005	1245
Race	Some Others	174	590.713	200.214	15.178	15	1405	300	464	580	700	830	960	1050	1152
Race	Hispanic	378	602.577	214.353	11.025	25	1440	265	480	587.5	720	865	958	1095	1213
Race	Refused	120	555.842	198.564	18.126	30	1405	285	440	534	630	762.5	875	1290	1295
Hispanic	No	8326	560.878	182.574	2.0009	3	1440	300	460	540	650	780	870	1000	1140
Hispanic	Yes	684	597.402	206.333	7.8893	15	1440	300	480	585	713	840	958	1095	1200
Hispanic	DK	43	542.279	169.881	25.907	135	1002	300	420	555	660	756	830	1002	1002
Hispanic	Refused	98	523.439	180.194	18.202	30	1295	255	415	515	600	735	795	930	1295
Employment	*	1736	679.52	185.535	4.453	15	1440	390	590	675	785	892	960	1065	1170
Employment	Full Time	3992	513.454	157.599	2.4943	3	1440	283	435	510	585	680	765	890	1000
Employment	Part Time	777	551.613	169.425	6.0781	15	1335	330	455	540	630	750	835	1005	1100
Employment	Not Employed	2578	566.409	191.218	3.7661	5	1440	300	478	540	650	780	905	1095	1223
Employment	Refused	68	513.971	209.558	25.413	30	1440	210	420	497.5	585	725	795	1200	1440
Education	*	1925	668.265	188.751	4.302	15	1440	360	575	663	780	885	960	1060	1170
Education	< High School	807	554.809	180.581	6.3567	5	1440	300	450	540	630	775	860	1015	1160
Education	High School Graduate	2549	534.057	176.208	3.4901	3	1440	285	447	520	607	720	835	975	1151
Education	< College	1740	539.07	176.123	4.2222	5	1440	282	450	530	615	735	825	1005	1135
Education	College Graduate	1223	526.025	164.899	4.7152	15	1404	300	445	515	600	713	785	965	1070
Education	Post Graduate	907	525.192	160.567	5.3315	3	1355	315	445	510	600	690	780	950	1095
Census Region	Northeast	2037	561.515	185.273	4.105	5	1440	300	457	540	655	781	885	1020	1139
Census Region	Midwest	2045	552.402	179.232	3.9634	3	1440	280	450	540	643	765	860	965	1035
Census Region	South	3156	570.023	186.38	3.3177	10	1440	300	465	552	660	790	900	1055	1155
Census Region	West	1913	564.897	186.373	4.2611	5	1440	305	460	540	660	793	875	995	1152
Day Of Week	Weekday	6169	552.611	174.489	2.2216	3	1440	325	450	539	635	760	855	975	1130
Day Of Week	Weekend	2982	584.861	202.361	3.7057	3	1440	223	480	570	690	825	920	1055	1170
Season	Winter	2475	576	183.782	3.6942	5	1440	305	475	555	660	805	900	1035	1148
Season	Spring	2365	558.956	176.729	3.6341	15	1440	315	455	540	655	770	855	960	1095
Season	Summer	2461	566.114	195.229	3.9354	3	1440	285	455	545	660	810	900	1030	1190
Season	Fall	1850	547.23	179.924	4.1832	3	1440	270	450	537.5	630	750	850	960	1100
Asthma	No	8420	560.814	182.769	1.9918	3	1440	300	460	540	655	780	870	1000	1140
Asthma	Yes	671	593.846	201.517	7.7795	30	1440	300	475	580	690	835	946	1060	1327
Asthma	DK	60	543.117	218.404	28.196	30	1295	223	423	540	605	760	982.5	1275	1295
Angina	No	8836	564.211	183.935	1.9568	3	1440	300	460	540	660	785	880	1005	1140
Angina	Yes	244	535.545	203.888	13.053	20	1440	215	450	522.5	612.5	770	840	1135	1230
Angina	DK	71	522.113	193.937	23.016	30	1295	180	420	540	600	690	820	990	1295
Bronchitis/Emphysema	No	8660	563.08	184.244	1.9799	3	1440	300	460	540	660	780	880	1005	1141
Bronchitis/Emphysema	Yes	423	570.102	192.041	9.3373	15	1440	294	450	555	660	795	900	1055	1110
Bronchitis/Emphysema	DK	68	524.765	186.701	22.641	30	1295	240	420	540	600	700	820	930	1295

Note: A "\*" Signifies missing data. "DK" = The respondent replied "don't know". Refused = Refused data. N = doer sample size. Mean = Mean 24-hour cumulative number of minutes for doers. Stdev = standard deviation. Stderr = standard error. Min = minimum number of minutes. Max = maximum number of minutes. Percentiles are the percentage of doers below or equal to a given number of minutes.  
Source: Tsang and Klepeis, 1996.



Table 15-116. Statistics for 24-Hour Cumulative Number of Minutes Spent at Home in the Garage

Category	Population Group	N	Mean	Stdev	Stderr	Min	Max	Percentiles							
								5	25	50	75	90	95	98	99
All		193	117.782	144.451	10.398	1	790	5	20	60	150	296	480	665	690
Gender	Male	120	144.058	162.612	14.844	2	790	10	30	93.5	182.5	315	518	675	690
Gender	Female	73	74.589	94.322	11.04	1	530	5	15	30	120	180	240	450	530
Age (years)	*	1	20	*	*	20	20	20	20	20	20	20	20	20	20
Age (years)	1-4	4	83.5	47.459	23.729	15	120	15	52	99.5	115	120	120	120	120
Age (years)	5-11	6	63.333	63.377	25.874	10	165	10	25	30	120	165	165	165	165
Age (years)	12-17	12	80.833	78.383	22.627	10	240	10	20	50.5	147.5	185	240	240	240
Age (years)	18-64	130	134.508	165.117	14.482	1	790	5	20	67.5	180	360	526	675	690
Age (years)	> 64	40	88.55	84.108	13.299	5	300	7.5	25	60	142.5	227.5	270	300	300
Race	White	165	109.509	127.523	9.928	1	690	5	20	60	135	240	315	526	675
Race	Black	12	205	219.483	63.359	5	570	5	37.5	90	405	530	570	570	570
Race	Asian	1	5	*	*	5	5	5	5	5	5	5	5	5	5
Race	Some Others	6	186.333	308.416	125.91	10	790	10	18	30	240	790	790	790	790
Race	Hispanic	8	120	164.859	58.287	15	510	15	22.5	60	135	510	510	510	510
Race	Refused	1	120	*	*	120	120	120	120	120	120	120	120	120	120
Hispanic	No	174	116.615	138.452	10.496	1	690	5	20	60	155	296	460	570	675
Hispanic	Yes	17	128.588	207.294	50.276	5	790	5	20	60	110	510	790	790	790
Hispanic	Refused	2	127.5	10.607	7.5	120	135	120	120	127.5	135	135	135	135	135
Employment	*	21	79.714	67.545	14.74	10	240	15	25	51	120	165	185	240	240
Employment	Full Time	85	145.259	175.17	19	1	790	5	20	65	180	405	530	675	790
Employment	Part Time	17	50.118	51.967	12.604	5	194	5	15	30	60	135	194	194	194
Employment	Not Employed	70	112.271	127.392	15.226	5	690	5	30	75	135	255	450	480	690
Education	*	22	76.545	67.572	14.406	10	240	10	20	50.5	120	165	185	240	240
Education	< High School	14	188.929	195.036	52.126	5	675	5	30	120	235	510	675	675	675
Education	High School Graduate	63	127.286	159.283	20.068	2	690	5	25	60	165	300	530	665	690
Education	< College	48	121.583	147.764	21.328	5	790	10	30	60	140	296	450	790	790
Education	College Graduate	25	118.2	145.773	29.155	5	480	5	20	60	120	405	460	480	480
Education	Post Graduate	21	75.857	88.067	19.218	1	300	2	10	30	120	195	260	300	300
Census Region	Northeast	23	137.174	159.451	33.248	5	510	15	30	60	195	460	510	510	510
Census Region	Midwest	42	131.381	166.398	25.676	10	690	20	40	87.5	120	260	665	690	690
Census Region	South	60	103.683	128.598	16.602	2	570	5	12.5	52.5	127.5	283	427.5	480	570
Census Region	West	68	115.265	139.682	16.939	1	790	5	20	72.5	152.5	300	315	530	790
Day Of Week	Weekday	116	128.664	158.968	14.76	1	790	5	25	60	165	315	510	665	690
Day Of Week	Weekend	77	101.39	118.416	13.495	2	675	10	20	60	120	240	300	526	675
Season	Winter	51	115.608	161.848	22.663	2	690	5	15	50	150	240	526	665	690
Season	Spring	59	136.763	163.341	21.265	5	790	10	30	90	165	315	570	675	790
Season	Summer	51	101.078	121.329	16.989	1	530	5	20	60	120	260	450	460	530
Season	Fall	32	112.875	110.217	19.484	5	480	10	25	85	157.5	240	315	480	480
Asthma	No	184	118.598	146.349	10.789	1	790	5	25	60	150	300	480	665	690
Asthma	Yes	9	101.111	102.585	34.195	5	270	5	15	60	180	270	270	270	270
Angina	No	187	118.219	146.174	10.689	1	790	5	20	60	150	300	480	665	690
Angina	Yes	6	104.167	78.639	32.104	10	220	10	25	110	150	220	220	220	220
Bronchitis/Emphysema	No	185	114.146	142.947	10.51	1	790	5	20	60	135	260	480	665	690
Bronchitis/Emphysema	Yes	8	201.875	163.64	57.856	15	450	15	60	177.5	337.5	450	450	450	450

Note: A "\*" Signifies missing data. "DK" = The respondent replied "don't know". Refused = Refused data. N = doer sample size. Mean = Mean 24-hour cumulative number of minutes for doers. Stdev = standard deviation. Stderr = standard error. Min = minimum number of minutes. Max = maximum number of minutes. Percentiles are the percentage of doers below or equal to a given number of minutes.  
Source: Tsang and Klepeis, 1996.



Table 15-117. Statistics for 24-Hour Cumulative Number of Minutes Spent in the Basement

Category	Population Group	N	Mean	Stdev	Stderr	Min	Max	Percentiles									
								5	25	50	75	90	95	98	99		
All		274	142.15	162.882	9.84	1	931	10	30	90	180	330	535	705	765		
Gender	Male	132	160.386	180.747	15.732	1	931	10	40	90	202.5	490	565	720	765		
Gender	Female	141	125.66	143.283	12.067	2	810	10	30	75	175	265	420	705	720		
Gender	Refused	1	60	*	*	60	60	60	60	60	60	60	60	60	60		
Age (years)	*	3	171.667	122.712	70.848	30	245	30	30	240	245	245	245	245	245		
Age (years)	1-4	8	94.75	55.695	19.691	28	180	28	47.5	90	137.5	180	180	180	180		
Age (years)	5-11	25	135.4	145.945	29.189	15	705	15	60	105	140	270	420	705	705		
Age (years)	12-17	26	97.462	113.063	22.173	1	515	10	30	60	150	240	275	515	515		
Age (years)	18-64	170	151.271	172.666	13.242	1	810	5	30	90	210	410	555	720	765		
Age (years)	> 64	42	143.833	173.502	26.772	5	931	10	40	90	170	330	455	931	931		
Race	White	248	133.75	154.08	9.784	1	810	10	30	90	167.5	315	510	705	720		
Race	Black	15	183.8	165.472	42.725	12	515	12	40	150	270	450	515	515	515		
Race	Asian	2	135	106.066	75	60	210	60	60	135	210	210	210	210	210		
Race	Some Others	3	468.667	455.654	263.072	20	931	20	20	455	931	931	931	931	931		
Race	Hispanic	1	30	*	*	30	30	30	30	30	30	30	30	30	30		
Race	Refused	5	263.2	173.071	77.4	60	540	60	231	240	245	540	540	540	540		
Hispanic	No	263	139.046	161.666	9.969	1	931	10	30	90	180	330	510	705	765		
Hispanic	Yes	6	185	197.332	80.561	15	555	15	30	150	210	555	555	555	555		
Hispanic	DK	1	185	*	*	185	185	185	185	185	185	185	185	185	185		
Hispanic	Refused	4	271.25	198.762	99.381	60	540	60	150	242.5	392.5	540	540	540	540		
Employment	*	57	115.561	124.205	16.451	1	705	12	40	90	150	240	420	515	705		
Employment	Full Time	107	149.075	178.633	17.269	1	810	5	30	75	210	450	540	720	765		
Employment	Part Time	22	115	114.808	24.477	10	535	25	60	77.5	150	185	290	535	535		
Employment	Not Employed	85	157.953	176.347	19.128	5	931	10	35	120	210	330	600	720	931		
Employment	Refused	3	151.667	110.265	63.661	30	245	30	30	180	245	245	245	245	245		
Education	*	65	129.492	133.447	16.552	1	705	15	45	90	160	270	420	535	705		
Education	< High School	15	169.867	203.464	52.534	5	605	5	30	90	255	565	605	605	605		
Education	High School Graduate	78	159.385	188.681	21.364	5	810	5	40	90	195	420	720	765	810		
Education	< College	48	160.583	184.204	26.588	2	931	10	25	120	202.5	400	600	931	931		
Education	College Graduate	39	146.744	150.808	24.149	10	555	10	30	70	210	450	510	555	555		
Education	Post Graduate	29	73.138	66.272	12.306	1	245	10	30	60	100	210	210	245	245		
Census Region	Northeast	90	115.611	118.744	12.517	5	555	10	40	72.5	150	250	400	540	555		
Census Region	Midwest	123	129.024	146.939	13.249	2	765	10	30	90	180	270	510	605	630		
Census Region	South	35	187.971	205.847	34.794	10	931	28	45	110	255	450	720	931	931		
Census Region	West	26	234.423	247.688	48.576	1	810	1	30	165	325	705	720	810	810		
Day Of Week	Weekday	178	135.331	159.404	11.948	1	810	10	30	82.5	180	315	535	720	765		
Day Of Week	Weekend	96	154.792	169.263	17.275	5	931	10	50	97.5	190	450	540	600	931		
Season	Winter	80	144.475	147.022	16.438	5	630	13.5	30	90	220.5	315	480	610	630		
Season	Spring	65	174.215	196.783	24.408	1	931	5	60	105	210	490	555	810	931		
Season	Summer	79	142.367	180.698	20.33	1	765	5	30	85	150	455	605	720	765		
Season	Fall	50	96.4	83.08	11.749	5	332	10	30	60	145	240	255	301	332		
Asthma	No	253	143.126	164.183	10.322	1	931	10	35	90	180	330	540	705	765		
Asthma	Yes	20	124.65	150.961	33.756	1	510	5.5	16	72.5	177.5	382.5	510	510	510		
Asthma	DK	1	245	*	*	245	245	245	245	245	245	245	245	245	245		
Angina	No	269	141.409	163.736	9.983	1	931	10	30	90	180	330	535	705	765		
Angina	Yes	3	201.667	122.1	70.494	65	300	65	65	240	300	300	300	300	300		
Angina	DK	2	152.5	130.815	92.5	60	245	60	60	152.5	245	245	245	245	245		
Bronchitis/Emphysema	No	265	138.996	160.98	9.889	1	931	10	30	90	180	330	515	705	765		
Bronchitis/Emphysema	Yes	8	233.75	214.172	75.721	20	605	20	67.5	180	375	605	605	605	605		
Bronchitis/Emphysema	DK	1	245	*	*	245	245	245	245	245	245	245	245	245	245		

Note: A "\*" Signifies missing data. "DK" = The respondent replied "don't know". Refused = Refused data. N = doer sample size. Mean = Mean 24-hour cumulative number of minutes for doers. Stdev = standard deviation. Stderr = standard error. Min = minimum number of minutes. Max = maximum number of minutes. Percentiles are the percentage of doers below or equal to a given number of minutes.  
Source: Tsang and Klepeis, 1996.



Table 15-118. Statistics for 24-Hour Cumulative Number of Minutes Spent at Home in the Utility Room or Laundry Room

Group Name	Group Code	N	Mean	Stdev	Stderr	Min	Max	Percentiles									
								5	25	50	75	90	95	98	99		
All		458	73.218	71.872	3.358	1	510	5	25	60	100	150	200	300	360		
Gender	Male	70	78.443	95.687	11.437	1	510	5	20	60	90	167.5	345	360	510		
Gender	Female	388	72.276	66.796	3.391	2	510	5	28	60	105	150	190	240	330		
Age (years)	*	6	65.833	34.412	14.049	25	120	25	40	60	90	120	120	120	120		
Age (years)	1-4	3	75	116.94	67.515	5	210	5	5	10	210	210	210	210	210		
Age (years)	5-11	3	105.667	168.423	97.239	2	300	2	2	15	300	300	300	300	300		
Age (years)	12-17	8	55.5	77.107	27.261	1	240	1	17	33	52.5	240	240	240	240		
Age (years)	18-64	362	73.58	73.87	3.882	2	510	5	20	60	105	150	195	325	405		
Age (years)	> 64	76	72.592	58.092	6.664	2	345	10	30	60	90	150	180	245	345		
Race	White	400	69.243	65.801	3.29	2	510	5	25	60	90	150	180	258	352.5		
Race	Black	35	100.514	103.238	17.45	1	510	5	20	60	135	240	300	510	510		
Race	Asian	4	82.5	37.749	18.875	30	120	30	60	90	105	120	120	120	120		
Race	Some Others	6	86.667	27.869	11.377	60	120	60	65	78	120	120	120	120	120		
Race	Hispanic	10	95.9	78.827	24.927	4	225	4	20	105	120	217.5	225	225	225		
Race	Refused	3	170	264.15	152.507	15	475	15	15	20	475	475	475	475	475		
Hispanic	No	435	72.069	69.87	3.35	1	510	5	25	60	90	150	190	300	360		
Hispanic	Yes	20	81.7	62.982	14.083	4	225	4.5	40	60	120	182.5	218	225	225		
Hispanic	DK	1	55	*	*	55	55	55	55	55	55	55	55	55	55		
Hispanic	Refused	2	247.5	321.734	227.5	20	475	20	20	248	475	475	475	475	475		
Employment	*	12	76.75	107.831	31.128	1	300	1	4	23	135	240	300	300	300		
Employment	Full Time	206	69.184	78.438	5.465	2	510	5	20	60	90	135	203	360	405		
Employment	Part Time	51	72.216	62.506	8.753	2	225	5	15	55	120	150	180	225	225		
Employment	Not Employed	187	77.679	63.835	4.668	5	475	10	30	60	115	150	180	245	345		
Employment	Refused	2	76	104.652	74	2	150	2	2	76	150	150	150	150	150		
Education	*	17	72	90.881	22.042	1	300	1	10	35	90	240	300	300	300		
Education	< High School	51	71.765	49.445	6.924	15	245	20	30	60	90	120	180	195	245		
Education	High School Graduate	163	71.583	71.583	5.607	2	510	6	30	60	90	140	180	325	405		
Education	< College	107	77.234	71.721	6.934	2	475	5	20	60	120	155	200	225	240		
Education	College Gradutae	60	74.033	77.252	9.973	5	510	10	27	60	97.5	154	190	203	510		
Education	Post Graduate	60	71.267	79.857	10.31	5	360	5	18	60	90	155	263	360	360		
Census Region	Northeast	105	80.933	84.595	8.256	2	510	5	25	60	120	180	225	345	360		
Census Region	Midwest	116	64.948	63.307	5.878	2	475	5	15	60	90	135	155	215	240		
Census Region	South	151	72.695	69.541	5.659	1	510	10	30	60	90	150	210	245	330		
Census Region	West	86	75.872	69.9	7.537	4	405	5	30	60	115	150	180	360	405		
Day Of Week	Weekday	322	68.643	66.724	3.718	1	510	5	23	60	90	140	180	240	345		
Day Of Week	Weekend	136	84.051	82.05	7.036	5	510	10	30	60	120	180	240	360	405		
Season	Winter	145	75.248	80.989	6.726	1	510	5	17	60	90	165	215	360	475		
Season	Spring	89	81.888	83.016	8.8	5	510	10	30	60	100	180	240	405	510		
Season	Summer	132	69.25	60.815	5.293	2	360	5	25	60	120	135	155	240	325		
Season	Fall	92	67.326	58.613	6.111	3	345	10	22	60	90	125	180	245	345		
Asthma	No	432	73.764	73.182	3.521	1	510	5	25	60	105	150	200	325	360		
Asthma	Yes	26	64.154	44.791	8.784	10	200	10	25	60	90	120	130	200	200		
Angina	No	440	72.134	70.217	3.347	1	510	5	25	60	100	150	185	270	360		
Angina	Yes	16	103.125	109.877	27.469	5	360	5	30	60	138	345	360	360	360		
Angina	DK	2	72.5	17.678	12.5	60	85	60	60	73	85	85	85	85	85		
Bronchitis/emphysema	No	428	73.276	73.484	3.552	1	510	5	24	60	105	150	200	325	360		
Bronchitis/emphysema	Yes	30	72.4	43.498	7.942	10	200	15	45	60	90	125	150	200	200		

Note: A "\*" Signifies missing data. "DK" = The respondent replied "don't know". Refused = Refused data. N = doer sample size. Mean = Mean 24-hour cumulative number of minutes for doers. Stdev = standard deviation. Stderr = standard error. Min = minimum number of minutes. Max = maximum number of minutes. Percentiles are the percentage of doers below or equal to a given number of minutes.

Source: Tsang and Klepeis, 1996.





Table 15-119. Statistics for 24-Hour Cumulative Number of Minutes Spent at Home in the Outdoor Pool or Spa

Category	Population Group	N	Mean	Stdev	Stderr	Min	Max	Percentiles							
								5	25	50	75	90	95	98	99
All		85	115.318	103.713	11.249	1	450	15	34	90	150	255	360	450	450
Gender	Male	34	113.676	106.758	18.309	5	450	10	45	75	150	258	360	450	450
Gender	Female	51	116.412	102.691	14.38	1	450	15	30	90	178	240	360	390	450
Age (years)	*	2	60	63.64	45	15	105	15	15	60	105	105	105	105	105
Age (years)	1-4	9	85.556	86.329	28.776	15	255	15	30	60	75	255	255	255	255
Age (years)	5-11	15	164.2	103.969	26.845	25	450	25	105	140	185	300	450	450	450
Age (years)	12-17	5	97	53.805	24.062	40	180	40	60	100	105	180	180	180	180
Age (years)	18-64	44	117.614	112.718	16.993	4	450	15	32	82.5	155	297	360	450	450
Age (years)	> 64	10	78.9	85.318	26.98	1	258	1	20	52.5	90	226.5	258	258	258
Race	White	75	120.893	107.723	12.439	1	450	15	34	90	180	258	360	450	450
Race	Black	5	66	59.729	26.711	10	150	10	20	45	105	150	150	150	150
Race	Some Others	1	105	*	*	105	105	105	105	105	105	105	105	105	105
Race	Hispanic	2	112.5	53.033	37.5	75	150	75	75	112.5	150	150	150	150	150
Race	Refused	2	37.5	31.82	22.5	15	60	15	15	37.5	60	60	60	60	60
Hispanic	No	78	116.821	104.631	11.847	1	450	10	34	90	160	255	360	450	450
Hispanic	Yes	5	123	108.374	48.466	30	300	30	60	75	150	300	300	300	300
Hispanic	Refused	2	37.5	31.82	22.5	15	60	15	15	37.5	60	60	60	60	60
Employment	*	29	128.207	96.956	18.004	15	450	20	60	105	178	255	300	450	450
Employment	Full Time	27	111.889	102.499	19.726	4	390	10	30	90	150	297	360	390	390
Employment	Part Time	2	237.5	300.52	212.5	25	450	25	25	237.5	450	450	450	450	450
Employment	Not Employed	26	98.962	94.835	18.599	1	360	5	30	67.5	130	240	258	360	360
Employment	Refused	1	15	*	*	15	15	15	15	15	15	15	15	15	15
Education	*	30	124.433	97.486	17.798	15	450	15	60	105	178	250	300	450	450
Education	< High School	8	109.375	155.367	54.93	5	450	5	15	37.5	157.5	450	450	450	450
Education	High School Graduate	15	150	130.516	33.699	1	390	1	45	105	240	360	390	390	390
Education	< College	17	80.529	66.66	16.167	4	240	4	30	75	90	225	240	240	240
Education	College Graduate	9	120.556	107.308	35.769	15	297	15	30	85	180	297	297	297	297
Education	Post Graduate	6	81.667	42.032	17.159	30	135	30	60	67.5	130	135	135	135	135
Census Region	Northeast	23	135.348	113.518	23.67	1	450	10	40	100	225	245	297	450	450
Census Region	Midwest	16	64.625	63.636	15.909	4	255	4	25	52.5	82.5	135	255	255	255
Census Region	South	23	114.696	78.499	16.368	15	390	20	60	105	150	185	210	390	390
Census Region	West	23	131.174	129.262	26.953	15	450	25	30	75	195	360	360	450	450
Day Of Week	Weekday	56	114.464	106.726	14.262	1	450	5	30	90	155	255	390	450	450
Day Of Week	Weekend	29	116.966	99.452	18.468	10	360	20	45	85	150	297	360	360	360
Season	Winter	10	118.9	159.415	50.412	4	450	4	20	30	135	405	450	450	450
Season	Spring	24	97.417	74.622	15.232	10	360	30	52.5	80	120	180	195	360	360
Season	Summer	47	124.511	104.25	15.206	1	450	15	40	90	185	255	300	450	450
Season	Fall	4	105.75	107.481	53.741	30	258	30	30	67.5	181.5	258	258	258	258
Asthma	No	73	109.89	105.481	12.346	1	450	10	30	75	140	255	360	450	450
Asthma	Yes	11	160.455	82.355	24.831	85	360	85	90	150	225	225	360	360	360
Asthma	DK	1	15	*	*	15	15	15	15	15	15	15	15	15	15
Angina	No	84	116.512	103.746	11.32	1	450	15	37	90	155	255	360	450	450
Angina	DK	1	15	*	*	15	15	15	15	15	15	15	15	15	15
Bronchitis/Emphysema	No	78	115.731	101.786	11.525	1	450	10	40	90	150	255	360	450	450
Bronchitis/Emphysema	Yes	6	126.667	137.792	56.253	15	360	15	25	67.5	225	360	360	360	360
Bronchitis/Emphysema	DK	1	15	*	*	15	15	15	15	15	15	15	15	15	15

Note: A "\*" Signifies missing data. "DK" = The respondent replied "don't know". Refused = Refused data. N = doer sample size. Mean = Mean 24-hour cumulative number of minutes for doers. Stdev = standard deviation. Stderr = standard error. Min = minimum number of minutes. Max = maximum number of minutes. Percentiles are the percentage of doers below or equal to a given number of minutes.  
Source: Tsang and Klepeis, 1996.



Table 15-120. Statistics for 24-Hour Cumulative Number of Minutes Spent at Home in the Yard or Other Areas Outside the House

Category	Population Group	N	Mean	Stdev	Stderr	Min	Max	Percentiles									
								5	25	50	75	90	95	98	99		
All		2308	137.587	144.112	2.9997	1	1290	10	40	90	180	320	420	570	660		
Gender	Male	1198	158.448	160.016	4.6231	1	1290	10	60	120	198	360	500	627	730		
Gender	Female	1107	114.887	120.869	3.6328	1	1065	5	30	75	150	285	360	450	560		
Gender	Refused	3	183.333	60.277	34.801	120	240	120	120	190	240	240	240	240	240		
Age (years)	*	27	167.37	164.484	31.6549	2	600	5	60	120	230	395	600	600	600		
Age (years)	1-4	151	135.311	111.483	9.0723	5	630	25	60	90	180	305	345	450	480		
Age (years)	5-11	271	150.594	135.111	8.2074	2	1250	20	60	120	190	310	405	553	570		
Age (years)	12-17	157	113.153	117.746	9.3972	2	660	5	30	80	150	240	405	462	610		
Age (years)	18-64	1301	136.382	147.923	4.1011	1	1080	5	30	90	180	330	435	570	715		
Age (years)	> 64	401	141.125	155.213	7.751	1	1290	10	45	90	180	302	465	598	660		
Race	White	1966	139.037	145.534	3.2823	1	1290	10	40	90	180	330	435	570	670		
Race	Black	173	128.416	144.607	10.9943	1	1250	5	30	95	180	270	390	462	745		
Race	Asian	21	101.19	88.485	19.3091	12	360	15	35	90	125	210	240	360	360		
Race	Some Others	37	183.541	161.858	26.6094	2	750	3	84	120	270	380	553	750	750		
Race	Hispanic	83	106.108	96.781	10.6231	2	610	5	35	75	145	240	270	330	610		
Race	Refused	28	152.321	151.049	28.5455	5	600	5	60	97.5	210	360	510	600	600		
Hispanic	No	2122	137.711	144.33	3.1332	1	1290	10	40	90	180	320	420	570	670		
Hispanic	Yes	153	125	134.265	10.8547	1	750	5	30	85	150	270	435	575	630		
Hispanic	DK	10	213.8	192.232	60.7892	3	585	3	60	145	380	503	585	585	585		
Hispanic	Refused	23	176.739	156.551	32.6431	5	600	5	60	160	240	360	510	600	600		
Employment	*	581	137.501	125.562	5.2092	2	1250	15	60	110	180	300	370	480	570		
Employment	Full Time	807	131.087	150.703	5.305	1	1080	5	30	80	175	307	450	600	745		
Employment	Part Time	166	126.145	134.084	10.407	1	1080	10	30	77.5	180	300	360	450	485		
Employment	Not Employed	739	146.097	149.672	5.5058	1	1290	10	45	100	185	360	465	585	655		
Employment	Refused	15	198	239.029	61.7171	5	660	5	30	120	465	600	660	660	660		
Education	*	615	136.348	125.656	5.0669	2	1250	15	60	105	180	300	370	480	570		
Education	< High School	236	161.017	186.469	12.1381	2	1290	10	45	105	195	390	510	765	915		
Education	High School Graduate	618	144.706	144.929	5.8299	1	840	5	40	100	195	360	479	555	660		
Education	< College	381	128.843	141.194	7.2336	1	1080	5	35	85	175	300	400	585	720		
Education	College Graduate	251	122.968	135.802	8.5717	1	750	10	30	75	160	300	390	575	690		
Education	Post Graduate	207	127.126	149.975	10.424	1	1065	5	30	78	150	320	435	570	630		
Census Region	Northeast	473	137.67	132.769	6.1047	1	750	10	45	90	185	317	420	532	600		
Census Region	Midwest	456	138.853	155.656	7.2893	2	1290	10	45	90	180	300	440	575	690		
Census Region	South	832	136.472	146.655	5.0843	1	1080	10	35	90	180	310	420	570	730		
Census Region	West	547	138.155	139.946	5.9837	1	750	5	36	90	180	330	460	570	630		
Day Of Week	Weekday	1453	126.919	131.579	3.4519	1	1250	5	35	90	165	300	395	553	610		
Day Of Week	Weekend	855	155.716	161.693	5.5298	1	1290	10	45	110	210	360	475	630	745		
Season	Winter	399	112.19	135.967	6.8068	1	1080	5	30	60	140	300	380	540	690		
Season	Spring	787	149.738	139.245	4.9635	1	915	10	60	120	195	338	430	555	660		
Season	Summer	796	143.681	155.886	5.5252	1	1290	10	45	99	180	330	450	610	715		
Season	Fall	326	124.457	130.523	7.229	1	720	10	35	87.5	160	300	380	510	655		
Asthma	No	2129	137.746	144.41	3.1297	1	1290	10	40	90	180	315	420	570	690		
Asthma	Yes	166	131.566	136.006	10.5561	1	670	10	30	90	165	345	450	553	610		
Asthma	DK	13	188.462	192.141	53.2904	5	600	5	60	90	300	480	600	600	600		
Angina	No	2228	136.521	141.088	2.989	1	1290	10	41	90	180	315	420	570	660		
Angina	Yes	63	158.683	216.341	27.2564	2	1080	5	30	75	180	420	485	1065	1080		
Angina	DK	17	199.118	191.305	46.3983	5	600	5	35	120	325	480	600	600	600		
Bronchitis/Emphysema	No	2191	138.793	144.994	3.0976	1	1290	10	45	90	180	320	430	570	690		
Bronchitis/Emphysema	Yes	105	104.438	111.282	10.86	1	553	5	30	60	145	270	360	415	475		
Bronchitis/Emphysema	DK	12	207.5	192.23	55.4919	5	600	5	60	140	330	480	600	600	600		

Note: A "\*" Signifies missing data. "DK" = The respondent replied "don't know". Refused = Refused data. N = doer sample size. Mean = Mean 24-hour cumulative number of minutes for doers. Stdev = standard deviation. Stderr = standard error. Min = minimum number of minutes. Max = maximum number of minutes. Percentiles are the percentage of doers below or equal to a given number of minutes.  
Source: Tsang and Klepeis, 1996.



Chapter 15 - Activity Factors

Table 15-121. Statistics for 24-Hour Cumulative Number of Minutes Spent Traveling in a Car

Category	Population Group	N	Mean	Stdev	Stderr	Min	Max	Percentiles									
								5	25	50	75	90	95	98	99		
All		6560	87.4261	88.186	1.0888	1	1280	10	34	63	110	175	240	345	450		
Gender	Male	2852	90.7398	97.337	1.8227	1	1280	10	30	63	115	185	254	360	526		
Gender	Female	3706	84.9069	80.374	1.3203	1	878	10	35	63.5	110	165	220	335	420		
Gender	Refused	2	30	14.142	10	20	40	20	20	30	40	40	40	40	40		
Age (years)	*	120	94.025	90.218	8.2358	7	593	10	37.5	71.5	120	180	222.5	435	450		
Age (years)	1-4	297	63.0101	56.758	3.2934	2	390	10	25	45	80	135	180	235	270		
Age (years)	5-11	449	64.6325	81.08	3.8264	1	900	5	20	40	85	145	175	310	345		
Age (years)	12-17	393	64.8346	70.974	3.5802	1	630	9	20	41	80	136	185	300	380		
Age (years)	18-64	4489	93.8278	92.302	1.3776	1	1280	13	40	70	120	184	250	360	495		
Age (years)	> 64	812	83.5283	79.436	2.7877	4	780	10	30	60	110	165	225	315	405		
Race	White	5337	87.6283	89.72	1.2281	1	1280	10	31	64	110	175	240	360	460		
Race	Black	640	86.8063	74.343	2.9387	1	690	10	35	65	115	180	240	305	330		
Race	Asian	117	78.7607	66.315	6.1309	5	360	20	35	60	95	135	225	320	330		
Race	Some Others	121	87.6942	84.48	7.68	3	540	10	30	60	120	180	250	330	345		
Race	Hispanic	265	90.0717	101.474	6.2335	2	825	15	35	65	100	165	235	465	620		
Race	Refused	80	82.4	73.314	8.1967	5	420	12	30	60	120	167.5	229.5	315	420		
Hispanic	No	5987	87.4657	87.603	1.1322	1	1280	10	35	65	110	175	240	345	440		
Hispanic	Yes	477	88.543	97.206	4.4507	2	825	10	30	60	103	180	240	388	595		
Hispanic	DK	29	63.8966	73.131	13.5801	5	325	6	20	40	60	187	200	325	325		
Hispanic	Refused	67	86.1194	78.361	9.5733	5	420	14	30	60	120	180	239	315	420		
Employment	*	1124	64.2482	72.331	2.1575	1	900	5	20	45	81	136	180	270	345		
Employment	Full Time	3134	93.5568	92.167	1.6464	2	1280	15	40	70	120	180	242	360	490		
Employment	Part Time	632	90.0506	81.969	3.2605	2	878	10	40	70	116.5	175	230	330	384		
Employment	Not Employed	1629	90.3603	90.224	2.2354	1	780	10	35	60	115	195	250	365	465		
Employment	Refused	41	97.1707	83.994	13.1176	10	330	15	30	75	120	220	290	330	330		
Education	*	1260	66.531	72.305	2.0369	1	900	6	21	45	85	145	186.5	270	350		
Education	< High School	434	86.0115	82.143	3.943	5	620	10	35	60	115	165	210	360	455		
Education	High School Graduate	1805	91.8476	91.088	2.144	1	870	10	38	65	115	190	255	385	465		
Education	< College	1335	93.2427	94.302	2.581	2	1280	10	36	70	120	180	250	380	460		
Education	College Graduate	992	95.6683	95.468	3.0311	4	840	14	40	73	120	185	250	370	580		
Education	Post Graduate	734	91.5395	82.009	3.027	4	905	20	40	75	115	175	235	330	380		
Census Region	Northeast	1412	85.8343	83.847	2.2314	1	780	10	33	60	110	170	240	330	410		
Census Region	Midwest	1492	89.0992	86.623	2.2426	4	825	10	35	65	112.5	180	250	360	465		
Census Region	South	2251	88.2625	89.347	1.8832	1	900	10	34	65	115	175	235	338	490		
Census Region	West	1405	85.9089	92.167	2.4589	2	1280	10	30	60	110	175	235	345	435		
Day Of Week	Weekday	4427	83.9248	85.023	1.2779	1	905	10	30	60	105	165	225	330	440		
Day Of Week	Weekend	2133	94.6929	94.018	2.0357	1	1280	10	35	70	120	190	265	360	455		
Season	Winter	1703	83.4692	82.128	1.9902	1	870	10	30	60	105	165	230	350	425		
Season	Spring	1735	88.589	91.537	2.1976	1	905	10	30	60	110	180	250	380	480		
Season	Summer	1767	88.0266	86.471	2.0571	1	900	10	35	65	115	170	235	330	450		
Season	Fall	1355	90.1269	93.173	2.5312	1	1280	10	35	70	115	170	240	335	545		
Asthma	No	6063	87.4143	88.032	1.1306	1	1280	10	34	63	110	175	240	350	450		
Asthma	Yes	463	88.2419	92.088	4.2797	4	870	15	34	64	110	165	245	345	505		
Asthma	DK	34	78.4118	57.362	9.8376	10	239	10	30	71	100	160	220	239	239		
Angina	No	6368	87.54	88.695	1.1115	1	1280	10	34	63.5	110	175	240	350	450		
Angina	Yes	154	82.1753	68.568	5.5254	8	365	10	30	60	115	162	214	285	320		
Angina	DK	38	89.6053	72.877	11.8221	10	360	10	35	73.5	120	180	239	360	360		
Bronchitis/Emphysema	No	6224	87.5517	88.855	1.1263	1	1280	10	34	62	110	175	240	350	450		
Bronchitis/Emphysema	Yes	300	85.5833	76.155	4.3968	1	505	10	35	68.5	109	185	237.5	305	435		
Bronchitis/Emphysema	DK	36	81.0556	63.142	10.5237	5	239	10	30	71	120	175	220	239	239		

Note: A "\*" Signifies missing data. "DK" = The respondent replied "don't know". Refused = Refused data. N = doer sample size. Mean = Mean 24-hour cumulative number of minutes for doers. Stdev = standard deviation. Stderr = standard error. Min = minimum number of minutes. Max = maximum number of minutes. Percentiles are the percentage of doers below or equal to a given number of minutes.

Source: Tsang and Klepeis, 1996.



Table 15-122. Statistics for 24-Hour Cumulative Number of Minutes Spent Traveling in a Truck (Pick-up/Van)

Group Name	Group Code	N	Mean	Stdev	Stderr	Min	Max	Percentiles								
								5	25	50	75	90	95	98	99	
All		1172	85.3	95.867	2.8003	1	955	10	30	60	110	180	240	395	478	
Gender	Male	760	91.097	105.368	3.8221	1	955	10	30	60	115	190	265	450	620	
Gender	Female	412	74.607	74.197	3.6554	1	510	10	25	55	95	165	220	300	355	
Age (years)	*	13	110.769	129.178	35.8274	10	450	10	35	60	90	300	450	450	450	
Age (years)	1-4	41	80.829	154.295	24.0969	1	955	10	15	35	70	206	210	955	955	
Age (years)	5-11	89	47.607	44.208	4.6861	1	240	7	15	30	65	110	130	180	240	
Age (years)	12-17	80	66.763	71.084	7.9475	5	352	5.5	15	37	93.5	180	222.5	265	352	
Age (years)	18-64	859	91.42	97.968	3.3426	2	750	10	30	60	115	189	260	440	555	
Age (years)	> 64	90	79	82.42	8.6878	10	453	12	30	48.5	105	185	265	390	453	
Race	White	1022	84.717	96.222	3.0099	1	955	10	30	60	110	180	235	390	510	
Race	Black	68	91.294	98.465	11.9406	6	453	14	27.5	62.5	105.5	220	295	450	453	
Race	Asian	3	138.333	63.311	36.5529	90	210	90	90	115	210	210	210	210	210	
Race	Some Others	20	67.2	48.46	10.836	5	165	7.5	25	62.5	102.5	137	154.5	165	165	
Race	Hispanic	48	92.792	99.31	14.3341	5	440	10	27.5	60	120	224	330	440	440	
Race	Refused	11	88.182	110.754	33.3935	10	390	10	30	60	65	190	390	390	390	
Hispanic	No	1069	85.112	95.567	2.9229	1	955	10	30	60	110	180	240	390	478	
Hispanic	Yes	87	89.103	100.75	10.8015	5	630	5	29	60	115	210	230	440	630	
Hispanic	DK	5	58	36.187	16.1833	20	97	20	20	68	85	97	97	97	97	
Hispanic	Refused	11	85.909	111.643	33.6615	10	390	10	30	35	65	190	390	390	390	
Employment	*	205	60.176	86.416	6.0355	1	955	7	15	30	75	146	185	240	265	
Employment	Full Time	642	93.288	101.354	4.0001	4	750	10	30	60	120	192	270	450	555	
Employment	Part Time	97	89.351	88.958	9.0323	2	460	6	30	60	120	190	270	450	460	
Employment	Not Employed	217	83.032	85.775	5.8228	5	655	10	30	60	110	180	235	300	355	
Employment	Refused	11	96.364	114.26	34.4508	10	390	10	30	35	170	190	390	390	390	
Education	*	230	64.043	86.936	5.7324	1	955	7	15	35	85	160	206	245	352	
Education	< High School	119	90.471	81.711	7.4904	5	453	14	35	60	120	195	280	295	450	
Education	High School Graduate	392	87.594	94.724	4.7843	2	675	10	30	60	115	185	255	450	510	
Education	< College	238	91.992	111.776	7.2454	4	750	10	30	60	110	190	290	555	655	
Education	College Graduate	127	85.228	74.586	6.6184	5	370	15	30	60	110	180	230	345	355	
Education	Post Graduate	66	112.439	117.975	14.5217	10	650	10	35	80	135	220	412	445	650	
Census Region	Northeast	170	85.365	104.161	7.9888	2	695	10	20	50	110	186	260	445	630	
Census Region	Midwest	268	91.209	94.43	5.7682	1	750	10	30	60	118.5	205	245	390	460	
Census Region	South	491	87.279	100.099	4.5174	4	955	10	30	60	111	180	235	445	595	
Census Region	West	243	74.741	81.299	5.2153	5	478	10	23	52	90	160	235	395	440	
Day Of Week	Weekday	796	80.083	90.569	3.2101	1	750	10	30	55	101	170	230	375	510	
Day Of Week	Weekend	376	96.346	105.493	5.4404	2	955	12	30	60.5	120	192	280	430	460	
Season	Winter	322	78.543	91.604	5.1049	1	955	10	29	51	95	170	220	355	445	
Season	Spring	300	92.477	100.164	5.783	1	695	10	30	60	120	208	267.5	442.5	549	
Season	Summer	323	86.133	99.255	5.5227	2	750	10	30	60	110	180	233	430	595	
Season	Fall	227	84.216	90.861	6.0306	5	675	10	30	60	105	165	265	395	465	
Asthma	No	1092	85.288	93.452	2.828	1	750	10	30	60	110	184	240	412	478	
Asthma	Yes	72	83.639	125.252	14.7611	5	955	10	20	46	115	170	235	395	955	
Asthma	DK	8	101.875	129.668	45.8446	10	390	10	20	60	127.5	390	390	390	390	
Angina	No	1142	84.868	95.219	2.8177	1	955	10	30	60	110	180	235	395	475	
Angina	Yes	20	93.4	116.003	25.939	5	555	7.5	37.5	70	103	140.5	350.5	555	555	
Angina	DK	10	118.5	128.583	40.6615	10	390	10	30	60	190	340	390	390	390	
Bronchitis/Emphysema	No	1128	85.469	96.579	2.8756	1	955	10	30	60	110	180	240	412	478	
Bronchitis/Emphysema	Yes	35	77.8	60.527	10.2308	5	240	5	30	60	120	165	220	240	240	
Bronchitis/Emphysema	DK	9	93.333	123.92	41.3068	10	390	10	20	60	65	390	390	390	390	

Note: A "\*" Signifies missing data. "DK" = The respondent replied "don't know". Refused = Refused data. N = doer sample size. Mean = Mean 24-hour cumulative number of minutes for doers. Stdev = standard deviation. Stderr = standard error. Min = minimum number of minutes. Max = maximum number of minutes. Percentiles are the percentage of doers below or equal to a given number of minutes.

Source: Tsang and Klepeis, 1996.



Table 15-123. Statistics for 24-Hour Cumulative Number of Minutes Spent Traveling on a Motorcycle, Moped, or Scooter

Category	Population Group	N	Mean	Stdev	Stderr	Min	Max	Percentiles							
								5	25	50	75	90	95	98	99
All		32	100.125	152.222	26.909	1	535	5	25	31	98	375	510	535	535
Gender	Male	29	104.276	158.322	29.4	1	535	5	25	32	80	485	510	535	535
Gender	Female	3	60	74.666	43.108	5	145	5	5	30	145	145	145	145	145
Age (years)	5-11	2	42.5	53.033	37.5	5	80	5	5	42.5	80	80	80	80	80
Age (years)	12-17	1	180	*	*	180	180	180	180	180	180	180	180	180	180
Age (years)	18-64	28	103.893	160.69	30.367	1	535	5	25	31	90.5	485	510	535	535
Age (years)	> 64	1	30	*	*	30	30	30	30	30	30	30	30	30	30
Race	White	31	101.516	154.532	27.755	1	535	5	25	30	116	375	510	535	535
Race	Black	1	57	*	*	57	57	57	57	57	57	57	57	57	57
Hispanic	No	31	102.387	154.191	27.693	1	535	5	25	32	116	375	510	535	535
Hispanic	Yes	1	30	*	*	30	30	30	30	30	30	30	30	30	30
Employment	*	3	88.333	87.797	50.69	5	180	5	5	80	180	180	180	180	180
Employment	Full Time	23	62.783	100.105	20.873	1	485	5	25	30	57	142	145	485	485
Employment	Not Employed	6	249.167	251.663	102.741	10	535	10	30	205	510	535	535	535	535
Education	*	3	88.333	87.797	50.69	5	180	5	5	80	180	180	180	180	180
Education	< High School	3	305	247.538	142.916	30	510	30	30	375	510	510	510	510	510
Education	High School Graduate	15	95.667	170.645	44.06	1	535	1	25	30	57	485	535	535	535
Education	< College	6	45.833	49.54	20.224	10	145	10	20	32.5	35	145	145	145	145
Education	College Graduate	4	70.5	51.423	25.712	20	142	20	37.5	60	103.5	142	142	142	142
Education	Post Graduate	1	32	*	*	32	32	32	32	32	32	32	32	32	32
Census Region	Northeast	6	24.167	8.01	3.27	10	30	10	20	27.5	30	30	30	30	30
Census Region	Midwest	12	191.583	216.501	62.499	1	535	1	28	68.5	430	510	535	535	535
Census Region	South	6	67.167	66.764	27.256	5	180	5	32	35	116	180	180	180	180
Census Region	West	8	44.625	44.654	15.788	5	142	5	15	30	60	142	142	142	142
Day Of Week	Weekday	21	71.333	110.425	24.097	5	510	5	25	32	65	145	180	510	510
Day Of Week	Weekend	11	155.091	205.865	62.071	1	535	1	20	30	375	485	535	535	535
Season	Winter	5	124	230.011	102.864	5	535	5	20	25	35	535	535	535	535
Season	Spring	12	121.833	153.631	44.349	1	485	1	28	43.5	143.5	375	485	485	485
Season	Summer	8	55.875	52.267	18.479	20	180	20	30	33.5	60	180	180	180	180
Season	Fall	7	96.429	184.249	69.639	5	510	5	5	30	80	510	510	510	510
Asthma	No	30	85.1	134.187	24.499	1	510	5	25	30	65	277.5	485	510	510
Asthma	Yes	2	325.5	296.278	209.5	116	535	116	116	325.5	535	535	535	535	535
Angina	No	31	102.387	154.191	27.693	1	535	5	25	32	116	375	510	535	535
Angina	Yes	1	30	*	*	30	30	30	30	30	30	30	30	30	30
Bronchitis/Emphysema	No	31	101.516	154.532	27.755	1	535	5	25	30	116	375	510	535	535
Bronchitis/Emphysema	Yes	1	57	*	*	57	57	57	57	57	57	57	57	57	57

Note: A "\*" Signifies missing data. N = doer sample size. Mean = Mean 24-hour cumulative number of minutes for doers. Stdev = standard deviation. Stderr = standard error. Min = minimum number of minutes. Max = maximum number of minutes. Percentiles are the percentage of doers below or equal to a given number of minutes. Source: Tsang and Klepeis, 1996.



Table 15-124. Statistics for 24-Hour Cumulative Number of Minutes Spent Traveling in Other Trucks

Category	Population Group	N	Mean	Stdev	Stderr	Min	Max	Percentiles							
								5	25	50	75	90	95	98	99
All		124	135.121	235.635	21.16	1	1440	5	25	48	107.5	270	690	960	1080
Gender	Male	80	174.888	283.085	31.65	1	1440	5	27	60	139	640	772.5	1080	1440
Gender	Female	44	62.818	57.438	8.659	1	270	5	20	45	90	145	180	270	270
Age (years)	*	1	35	*	*	35	35	35	35	35	35	35	35	35	35
Age (years)	1-4	4	79	26.47	13.235	46	105	46	58	82.5	100	105	105	105	105
Age (years)	5-11	9	37.875	28.002	9.9	10	95	10	18.5	30	50.5	95	95	95	95
Age (years)	12-17	7	116.857	83.071	31.398	10	250	10	60	90	195	250	250	250	250
Age (years)	18-64	96	153.24	263.424	26.886	1	1440	5	22.5	45	117	600	750	1080	1440
Age (years)	> 64	9	71.5	57.887	20.466	18	186	18	25	60	99	186	186	186	186
Race	White	110	1440	242.807	23.151	1	1440	5	25	60	120	412.5	735	960	1080
Race	Black	8	46.125	36.314	12.839	10	100	10	15	32.5	82	100	100	100	100
Race	Asian	1	40	*	*	40	40	40	40	40	40	40	40	40	40
Race	Some Others	1	95	*	*	95	95	95	95	95	95	95	95	95	95
Race	Hispanic	3	246.333	366.947	211.86	29	670	29	29	40	670	670	670	670	670
Race	Refused	1	35	*	*	35	35	35	35	35	35	35	35	35	35
Hispanic	No	113	133.673	240.595	22.633	1	1440	5	20	45	100	270	735	960	1080
Hispanic	Yes	9	170	200.709	66.903	29	670	29	41	105	180	670	670	670	670
Hispanic	DK	1	85	*	*	85	85	85	85	85	85	85	85	85	85
Hispanic	Refused	1	35	*	*	35	35	35	35	35	35	35	35	35	35
Employment	*	18	79.278	63.15	14.885	10	250	10	35	65	95	195	250	250	250
Employment	Full Time	79	168.468	286.399	32.222	1	1440	5	20	45	114	670	795	1080	1440
Employment	Part Time	6	96	103.894	42.415	2	255	2	5	55	180	255	255	255	255
Employment	Not Employed	19	75.105	57.278	13.14	10	186	10	25	75	120	180	186	186	186
Employment	Refused	2	20	21.213	15	5	35	5	5	20	35	35	35	35	35
Education	*	21	70.333	62.607	13.662	5	250	10	25	60	95	138	195	250	250
Education	< High School	10	389	505.656	159.9	5	1440	5	25	45	750	1117.5	1440	1440	1440
Education	High School Graduate	48	156.958	257.81	37.212	1	1080	5	19	52.5	130	610	690	1080	1080
Education	< College	24	116.25	124.385	25.39	29	600	32	42.5	77.5	120	255	270	600	600
Education	College Graduate	10	53	53.24	16.836	10	180	10	15	30	90	135	180	180	180
Education	Post Graduate	11	48.545	55.111	16.617	1	186	1	15	30	78	103	186	186	186
Census Region	Northeast	28	119.179	237.794	44.939	2	1080	5	27.5	45.5	90	180	795	1080	1080
Census Region	Midwest	36	189.194	318.577	53.096	1	1440	5	17	45	197.5	600	960	1440	1440
Census Region	South	42	100.595	151.868	23.434	1	750	5	22	55	114	186	205	750	750
Census Region	West	18	132.333	194.344	45.807	10	670	10	35	67.5	105	610	670	670	670
Day Of Week	Weekday	82	134.793	197.96	21.861	1	795	5	25	60	120	555	670	750	795
Day Of Week	Weekend	42	135.762	298.573	46.071	1	1440	5	18	45	75	250	960	1440	1440
Season	Winter	36	126.444	219.584	36.597	5	1080	10	26	53	92.5	270	670	1080	1080
Season	Spring	29	199.793	350.125	65.017	1	1440	5	15	35	180	795	960	1440	1440
Season	Summer	38	87.447	125.316	20.329	2	750	5	32	60	95	195	255	750	750
Season	Fall	21	146.952	213.871	46.67	1	735	15	30	74	120	600	600	735	735
Asthma	No	116	133.69	238.543	22.148	1	1440	5	21	48	104	270	735	960	1080
Asthma	Yes	7	173.143	210.169	79.436	32	610	32	35	60	250	610	610	610	610
Asthma	DK	1	35	*	*	35	35	35	35	35	35	35	35	35	35
Angina	No	120	138.725	238.702	21.79	1	1440	5	25	60	112	412.5	712.5	960	1080
Angina	Yes	3	24.333	13.65	7.881	15	40	15	15	18	40	40	40	40	40
Angina	DK	1	35	*	*	35	35	35	35	35	35	35	35	35	35
Bronchitis/Emphysema	No	116	135.612	242.76	22.54	1	1440	5	23.5	45	101.5	555	735	960	1080
Bronchitis/Emphysema	Yes	7	141.286	83.38	31.515	18	250	18	60	180	195	250	250	250	250
Bronchitis/Emphysema	DK	1	35	*	*	35	35	35	35	35	35	35	35	35	35

Note: A "\*" Signifies missing data. "DK" = The respondent replied "don't know". Refused = Refused data. N = doer sample size. Mean = Mean 24-hour cumulative number of minutes for doers. Stdev = standard deviation. Stderr = standard error. Min = minimum number of minutes. Max = maximum number of minutes. Percentiles are the percentage of doers below or equal to a given number of minutes.

Source: Tsang and Klepeis, 1996.



Table 15-125. Statistics for 24-Hour Cumulative Number of Minutes Spent Traveling on a Bus

Category	Population Group	N	Mean	Stdev	Stderr	Min	Max	Percentiles								
								5	25	50	75	90	95	98	99	
All		469	74.648	93.532	4.3189	2	945	10	30	55	90	125	180	435	570	
Gender	Male	219	77.251	104.119	7.0357	5	945	10	30	55	90	135	180	460	570	
Gender	Female	250	72.368	83.306	5.2688	2	640	15	30	55	90	120	175	420	501	
Age (years)	*	14	145	167.177	44.68	10	605	10	60	100	140	435	605	605	605	
Age (years)	1-4	5	56	40.218	17.986	15	120	15	30	55	60	120	120	120	120	
Age (years)	5-11	133	48.383	29.431	2.552	5	140	10	25	43	67	90	110	120	122	
Age (years)	12-17	143	59.413	46.343	3.8754	7	370	10	30	54	75	110	135	179	225	
Age (years)	18-64	147	96.639	128.354	10.587	2	945	10	30	60	110	180	405	640	690	
Age (years)	> 64	27	131.963	144.641	27.836	10	570	20	45	73	130	435	460	570	570	
Race	White	311	70.071	89.462	5.0729	2	945	10	30	54	80	120	147	405	501	
Race	Black	101	85.178	92.396	9.1937	5	570	15	35	60	110	140	185	460	468	
Race	Asian	15	58	58.487	15.101	5	175	5	20	20	120	155	175	175	175	
Race	Some Others	14	107.143	176.48	47.166	20	690	20	30	42.5	100	225	690	690	690	
Race	Hispanic	24	65.542	71.515	14.598	15	370	20	30	42.5	87	90	120	370	370	
Race	Refused	4	168	196.195	98.098	10	435	10	21	113.5	315	435	435	435	435	
Hispanic	No	415	72.839	86.077	4.2253	2	945	10	30	55	90	125	165	420	468	
Hispanic	Yes	46	83.913	138.922	20.483	7	690	15	30	37.5	85	145	370	690	690	
Hispanic	DK	2	47.5	10.607	7.5	40	55	40	40	47.5	55	55	55	55	55	
Hispanic	Refused	6	137.833	159.631	65.169	10	435	10	32	77.5	195	435	435	435	435	
Employment	*	274	54.018	39.364	2.3781	5	370	10	29	49.5	70	100	120	150	179	
Employment	Full Time	95	122.579	168.8	17.319	5	945	10	30	60	120	405	570	690	945	
Employment	Part Time	34	83.265	79.298	13.6	2	468	10	40	60	100	135	185	468	468	
Employment	Not Employed	61	80.262	69.212	8.8617	5	460	10	30	65	120	135	165	205	460	
Employment	Refused	5	167.4	169.916	75.989	10	435	10	32	165	195	435	435	435	435	
Education	*	295	55.302	44.964	2.6179	5	435	10	29	49	70	100	120	155	225	
Education	< High School	25	120.4	124.272	24.854	10	570	30	45	90	135	195	405	570	570	
Education	High School Graduate	57	111.579	116.718	15.46	10	501	20	45	73	120	225	435	468	501	
Education	< College	38	108.842	133.431	21.645	10	640	20	40	75	120	195	605	640	640	
Education	College Graduate	30	84.633	128.087	23.385	2	690	5	30	60	90	130	300	690	690	
Education	Post Graduate	24	110.458	199.236	40.669	5	945	10	29	60	101.5	125	460	945	945	
Census Region	Northeast	145	77.062	75.41	6.2624	7	435	15	30	60	95	135	180	435	435	
Census Region	Midwest	102	69.676	103.283	10.227	2	945	10	30	55	85	120	125	175	468	
Census Region	South	142	71.718	82.846	6.9523	5	570	10	30	50	80	135	180	460	501	
Census Region	West	80	81.813	124.342	13.902	5	690	12.5	30	41.5	90	127.5	297.5	640	690	
Day Of Week	Weekday	426	70.61	84.646	4.1011	2	690	10	30	50	85	120	165	435	501	
Day Of Week	Weekend	43	114.651	152.229	23.215	10	945	20	45	90	120	180	300	945	945	
Season	Winter	158	78.285	98.116	7.8057	5	690	10	30	58	90	125	180	435	605	
Season	Spring	140	61.636	53.541	4.525	2	460	10	30	50	75	120	137.5	205	225	
Season	Summer	94	86.617	116.695	12.036	5	945	10	30	60	95	155	225	435	945	
Season	Fall	77	76.234	107.505	12.251	5	640	10	30	50	80	125	175	570	640	
Asthma	No	413	76.448	96.792	4.7628	2	945	10	30	55	90	125	180	435	570	
Asthma	Yes	50	55.36	39.329	5.562	5	195	10	30	47.5	71	115	135	165	195	
Asthma	DK	6	111.5	161.48	65.924	10	435	10	32	46	100	435	435	435	435	
Angina	No	459	73.373	91.312	4.2621	2	945	10	30	55	90	125	179	420	570	
Angina	Yes	4	168.75	182.683	91.341	20	435	20	60	110	277.5	435	435	435	435	
Angina	DK	6	109.5	162.362	66.284	10	435	10	30	41	100	435	435	435	435	
Bronchitis/Emphysema	No	442	74.814	94.281	4.4845	2	945	10	30	55	90	125	180	435	570	
Bronchitis/Emphysema	Yes	19	58.158	39.881	9.1493	10	155	10	30	55	65	125	155	155	155	
Bronchitis/Emphysema	DK	8	104.625	137.907	48.757	10	435	10	28.5	67.5	100	435	435	435	435	

Note: A "\*" Signifies missing data. "DK" = The respondent replied "don't know". Refused = Refused data. N = doer sample size. Mean = Mean 24-hour cumulative number of minutes for doers. Stdev = standard deviation. Stderr = standard error. Min = minimum number of minutes. Max = maximum number of minutes. Percentiles are the percentage of doers below or equal to a given number of minutes.  
Source: Tsang and Klepeis, 1996.



Table 15-126. Statistics for 24-Hour Cumulative Number of Minutes Spent Walking

Category	Population Group	N	Mean	Stdev	Stderr	Min	Max	Percentiles									
								5	25	50	75	90	95	98	99		
All		1639	29.6718	41.617	1.028	1	540	2	6	16	39	65	95	151	190		
Gender	Male	755	32.4781	48.2611	1.7564	1	540	2	7	20	40	70	100	170	270		
Gender	Female	883	27.2831	34.8259	1.172	1	360	2	6	15	35	60	94	140	171		
Gender	Refused	1	20	*	*	20	20	20	20	20	20	20	20	20	20		
Age (years)	*	38	29.5263	23.7416	3.8514	1	100	2	10	25	40	60	80	100	100		
Age (years)	1-4	58	24.3276	26.3268	3.4569	1	160	2	10	15	35	60	60	70	160		
Age (years)	5-11	155	18.2129	21.0263	1.6889	1	170	1	5	10	25	40	60	65	100		
Age (years)	12-17	223	25.8341	32.3753	2.168	1	190	2	6	15	30	60	100	135	151		
Age (years)	18-64	944	31.8252	44.9705	1.4637	1	410	2	6	18.5	40	70	110	171	250		
Age (years)	> 64	221	33.81	49.3278	3.3181	1	540	2	10	20	45	73	95	155	180		
Race	White	1289	29.5912	43.6801	1.2166	1	540	2	6	15	35	65	100	160	225		
Race	Black	175	34.8114	39.7274	3.0031	1	250	2	10	20	50	75	125	160	194		
Race	Asian	36	26.5556	24.6535	4.1089	1	100	1	10	20	30	60	78	100	100		
Race	Some Others	30	23.7667	21.2192	3.8741	1	60	1	6	17	43	60	60	60	60		
Race	Hispanic	88	23.0795	21.1058	2.2499	1	100	2	5.5	15	37	50	60	92	100		
Race	Refused	21	33.1905	32.9555	7.1915	4	150	8	15	20	40	65	65	150	150		
Hispanic	No	1467	29.8718	41.0288	1.0712	1	410	2	6	16	40	65	100	155	194		
Hispanic	Yes	144	26.8403	48.7064	4.0589	1	540	2	5.5	15	35	60	70	100	135		
Hispanic	DK	10	30.2	28.8359	9.1187	2	80	2	10	17.5	55	77.5	80	80	80		
Hispanic	Refused	18	35.7222	34.7847	8.1988	8	150	8	15	25	55	65	150	150	150		
Employment	*	431	22.768	28.0141	1.3494	1	190	2	5	13	30	55	65	131	151		
Employment	Full Time	561	30.9519	43.7734	1.8481	1	365	2	7	16	40	70	100	180	250		
Employment	Part Time	153	26.8693	37.1231	3.0012	1	295	2	5	15	35	60	92	135	165		
Employment	Not Employed	482	35.5249	49.4109	2.2506	1	540	2	10	20	50	75	120	150	250		
Employment	Refused	12	18.4167	13.4601	3.8856	5	55	5	10	16.5	20	30	55	55	55		
Education	*	472	22.6737	27.6375	1.2721	1	190	2	5	13	30	55	65	130	151		
Education	< High School	138	42.7174	71.9429	6.1242	1	540	3	7	20	50	115	145	360	365		
Education	High School Graduate	366	29.2596	41.5618	2.1725	1	410	2	5	18	35	65	100	150	240		
Education	< College	288	32.5313	39.3063	2.3161	1	295	2	9.5	20	45	75	100	160	180		
Education	College Graduate	210	29.7667	38.813	2.6784	1	300	2	8	18.5	40	60	90	140	225		
Education	Post Graduate	165	34.5818	44.6107	3.4729	1	360	2	10	20	45	80	95	180	200		
Census Region	Northeast	507	34.9172	45.2549	2.0098	1	365	2	10	20	45	75	107	170	250		
Census Region	Midwest	321	29.271	46.8743	2.6163	1	540	2	6	15	31	60	105	160	180		
Census Region	South	423	24.9976	37.6654	1.8314	1	410	2	5	10	30	60	80	135	171		
Census Region	West	388	28.2448	35.029	1.7783	1	285	2	8	15	40	60	90	140	180		
Day Of Week	Weekday	1182	29.2902	39.1911	1.1399	1	540	2	7	18	40	65	92	145	180		
Day Of Week	Weekend	457	30.6586	47.3511	2.215	1	410	2	5	15	35	60	120	171	200		
Season	Winter	412	32.3034	47.7062	2.3503	1	365	2	6	20	38.5	75	120	180	250		
Season	Spring	459	28.854	41.54	1.9389	1	540	2	6	16	35	60	90	146	180		
Season	Summer	475	26.6084	31.325	1.4373	1	270	2	6	15	35	60	85	123	160		
Season	Fall	293	32.2184	46.6936	2.7279	1	410	2	8	20	45	61	105	155	295		
Asthma	No	1504	29.6011	41.9939	1.0828	1	540	2	6	16	35.5	65	95	152	190		
Asthma	Yes	120	29.7417	38.3451	3.5004	1	250	2	5	15	40	70	117.5	135	150		
Asthma	DK	15	36.2	27.8162	7.1821	5	90	5	10	30	60	75	90	90	90		
Angina	No	1578	29.5076	41.4718	1.044	1	540	2	6	16	38	65	95	151	190		
Angina	Yes	44	29	36.0633	5.4367	2	150	4	6	14.5	36	60	115	150	150		
Angina	DK	17	46.6471	63.1456	15.3151	5	270	5	10	30	60	90	270	270	270		
Bronchitis/Emphysema	No	1553	29.7173	42.1023	1.0684	1	540	2	6	16	38	65	95	151	194		
Bronchitis/Emphysema	Yes	67	26.9851	31.8774	3.8944	1	165	2	5	16	40	60	90	130	165		
Bronchitis/Emphysema	DK	19	35.4211	31.3658	7.1958	3	110	3	10	30	60	90	110	110	110		

Note: A "\*" Signifies missing data. "DK" = The respondent replied "don't know". Refused = Refused data. N = doer sample size. Mean = Mean 24-hour cumulative number of minutes for doers. Stdev = standard deviation. Stderr = standard error. Min = minimum number of minutes. Max = maximum number of minutes. Percentiles are the percentage of doers below or equal to a given number of minutes.

Source: Tsang and Klepeis, 1996.





Table 15-127. Statistics for 24-Hour Cumulative Number of Minutes Spent Traveling on a Bicycle/Skateboard/Rollerskate

Group Name	Group Code	N	Mean	Stdev	Stderr	Min	Max	Percentiles									
								5	25	50	75	90	95	98	99		
All		115	45.1217	53.35	4.9749	1	400	5	11	30	60	102	151	195	205		
Gender	Male	82	43.2073	56.113	6.1966	1	400	5	10	27.5	50	90	120	195	400		
Gender	Female	33	49.8788	46.228	8.0472	5	205	5	15	45	60	105	165	205	205		
Age (years)	*	2	15	7.071	5	10	20	10	10	15	20	20	20	20	20		
Age (years)	1-4	2	20	14.142	10	10	30	10	10	20	30	30	30	30	30		
Age (years)	5-11	18	40.2778	52.985	12.4886	1	195	1	10	15	55	151	195	195	195		
Age (years)	12-17	33	31.9697	27.929	4.8618	2	115	5	10	25	45	65	102	115	115		
Age (years)	18-64	53	53.2264	62.916	8.6422	5	400	5	20	30	65	105	165	180	400		
Age (years)	> 64	7	74	67.295	25.4353	23	205	23	25	35	110	205	205	205	205		
Race	White	98	46.7245	56.914	5.7492	1	400	5	11	30	60	110	165	205	400		
Race	Black	7	41.1429	21.737	8.2156	5	65	5	25	50	60	65	65	65	65		
Race	Asian	2	6	1.414	1	5	7	5	5	6	7	7	7	7	7		
Race	Some Others	4	47.5	23.629	11.8145	30	80	30	30	40	65	80	80	80	80		
Race	Hispanic	3	33.3333	25.166	14.5297	10	60	10	10	30	60	60	60	60	60		
Race	Refused	1	20	*	*	20	20	20	20	20	20	20	20	20	20		
Hispanic	No	106	45.8679	55.172	5.3587	1	400	5	10	30	60	105	151	195	205		
Hispanic	Yes	8	38.375	23.323	8.2461	10	80	10	23.5	30	55	80	80	80	80		
Hispanic	Refused	1	20	*	*	20	20	20	20	20	20	20	20	20	20		
Employment	*	52	33.8462	38.258	5.3054	1	195	2	10	20	47.5	65	115	151	195		
Employment	Full Time	27	56.8519	76.863	14.7923	5	400	5	15	30	60	115	120	400	400		
Employment	Part Time	7	40.8571	24.768	9.3616	10	90	10	30	35	46	90	90	90	90		
Employment	Not Employed	27	55.4815	54.258	10.442	5	205	5	20	30	90	165	180	205	205		
Employment	Refused	2	55	49.497	35	20	90	20	20	55	90	90	90	90	90		
Education	*	56	33.3929	36.945	4.937	1	195	2	10	20	45	65	115	151	195		
Education	< High School	3	98.3333	77.835	44.9382	25	180	25	25	90	180	180	180	180	180		
Education	High School Graduate	18	41.5556	49.048	11.5606	5	205	5	15	30	46	100	205	205	205		
Education	< College	18	42.9444	35.049	8.261	5	120	5	20	30	60	115	120	120	120		
Education	College Graduate	11	89.8182	111.308	33.5605	15	400	15	25	53	90	165	400	400	400		
Education	Post Graduate	9	57.2222	38.415	12.8049	5	110	5	20	60	90	110	110	110	110		
Census Region	Northeast	20	42.05	35.057	7.839	5	102	5	10	32.5	77.5	95	101	102	102		
Census Region	Midwest	24	39.125	47.505	9.6969	2	180	5	10	18.5	57.5	90	165	180	180		
Census Region	South	26	64.6923	87.03	17.0681	1	400	2	15	32.5	75	195	205	400	400		
Census Region	West	45	38.3778	32.614	4.8619	5	151	5	18	30	50	80	115	151	151		
Day Of Week	Weekday	83	44.5783	56.02	6.149	5	400	5	15	30	60	90	151	205	400		
Day Of Week	Weekend	32	46.5313	46.508	8.2215	1	195	2	10	32.5	75	110	120	195	195		
Season	Winter	20	38.6	44.951	10.0513	1	205	3.5	12.5	27.5	47.5	75	147.5	205	205		
Season	Spring	46	34.7826	35.036	5.1657	5	195	5	10	22.5	46	80	90	195	195		
Season	Summer	34	61.7059	72.243	12.3896	2	400	5	20	42.5	90	115	165	400	400		
Season	Fall	15	47.9333	55.663	14.3721	2	180	2	10	20	75	151	180	180	180		
Asthma	No	95	48.5368	57.246	5.8733	1	400	5	15	30	60	110	165	205	400		
Asthma	Yes	18	29.3333	24.22	5.7086	5	90	5	7	32.5	40	60	90	90	90		
Asthma	DK	2	25	7.071	5	20	30	20	20	25	30	30	30	30	30		
Angina	No	114	45.3421	53.533	5.0138	1	400	5	11	30	60	102	151	195	205		
Angina	DK	1	20	*	*	20	20	20	20	20	20	20	20	20	20		
Bronchitis/Emphysema	No	109	45.1284	53.909	5.1636	1	400	5	15	30	60	102	151	195	205		
Bronchitis/Emphysema	Yes	5	50	49.624	22.1923	5	115	5	10	30	90	115	115	115	115		
Bronchitis/Emphysema	DK	1	20	*	*	20	20	20	20	20	20	20	20	20	20		

Note: A "\*" Signifies missing data. "DK" = The respondent replied "don't know". Refused = Refused data. N = doer sample size. Mean = Mean 24-hour cumulative number of minutes for doers. Stdev = standard deviation. Stderr = standard error. Min = minimum number of minutes. Max = maximum number of minutes.

Percentiles are the percentage of doers below or equal to a given number of minutes.

Source: Tsang and Klepeis, 1996.



Table 15-128. Statistics for 24-Hour Cumulative Number of Minutes Spent Waiting on a Bus, Train, etc. Stop

Category	Population Group	N	Mean	Stdev	Stderr	Min	Max	Percentiles							
								5	25	50	75	90	95	98	99
All		151	18.702	18.7513	1.526	1	128	4	7	15	20	40	45	67	120
Gender	Male	61	16.3443	17.9934	2.3038	1	120	4	5	11	20	30	45	65	120
Gender	Female	90	20.3	19.1818	2.02319	1	128	4	10	15	30	42.5	60	75	128
Age (years)	*	2	21	5.6569	4	17	25	17	17	21	25	25	25	25	25
Age (years)	1-4	2	8	9.8995	7	1	15	1	1	8	15	15	15	15	15
Age (years)	5-11	32	12.5	10.7283	1.8965	2	45	2	5	10	15	20	43	45	45
Age (years)	12-17	50	13.78	11.4843	1.6241	1	74	3	5	10	20	23	30	52.5	75
Age (years)	18-64	54	25.5	25.616	3.4859	1	128	5	10	15	30	60	67	120	128
Age (years)	> 64	11	27.2727	13.484	4.0656	5	45	5	20	30	40	45	45	45	45
Race	White	115	18.2522	17.9501	1.6739	1	128	4	5	15	22	40	45	67	75
Race	Black	21	17.4762	11.9901	2.6164	1	45	3	10	15	23	35	40	45	45
Race	Asian	3	10	5	2.8868	5	15	5	5	10	15	15	15	15	15
Race	Some Others	1	15	*	*	15	15	15	15	15	15	15	15	15	15
Race	Hispanic	10	29.8	35.8137	11.3253	5	120	5	10	16.5	20	92.5	120	120	120
Race	Refused	1	15	*	*	15	15	15	15	15	15	15	15	15	15
Hispanic	No	136	18.0956	17.1036	1.4666	1	128	4	6	15	22.5	40	45	67	75
Hispanic	Yes	13	25.2308	32.4427	8.998	1	120	1	10	15	20	65	120	120	120
Hispanic	DK	1	20	*	*	20	20	20	20	20	20	20	20	20	20
Hispanic	Refused	1	15	*	*	15	15	15	15	15	15	15	15	15	15
Employment	*	79	13.1646	11.3707	1.2793	1	75	2	5	10	15	23	35	45	75
Employment	Full Time	31	24.9355	24.8125	4.4565	1	128	5	10	15	30	45	65	128	128
Employment	Part Time	15	31.6667	31.5179	8.1379	5	120	5	10	17	45	67	120	120	120
Employment	Not Employed	26	20.6154	12.7061	2.4919	5	45	5	10	20	30	40	45	45	45
Education	*	87	12.931	10.9723	1.1763	1	75	3	5	10	15	23	30	45	75
Education	< High School	6	32.5	11.726	4.7871	15	45	15	25	32.5	45	45	45	45	45
Education	High School Graduate	25	23.56	24.5749	4.915	5	120	5	10	15	30	45	67	120	120
Education	< College	9	28.333	19.2029	6.401	10	60	10	10	20	45	60	60	60	60
Education	College Graduate	16	33.8125	31.1239	7.781	5	128	5	10	30	37.5	65	128	128	128
Education	Post Graduate	8	14.875	8.3741	2.9607	1	30	1	40.5	15	18.5	30	30	30	30
Census Region	Northeast	63	20.4921	23.43	2.9519	1	128	3	6	15	22	40	65	120	128
Census Region	Midwest	27	17.4074	13.1244	2.5258	3	60	4	5	15	20	35	35	60	60
Census Region	South	39	19.8205	16.6684	2.6691	4	75	5	10	15	28	45	65	75	75
Census Region	West	22	13.1818	11.3458	2.4189	1	45	1	5	10	15	30	30	45	45
Day Of Week	Weekday	128	17.7891	18.9656	1.6763	1	128	3	5.5	15	20	35	45	75	120
Day Of Week	Weekend	23	23.7826	17.0026	3.5453	5	65	5	10	20	35	45	60	65	65
Season	Winter	55	19.9273	15.5693	2.0994	1	75	2	10	15	25	43	60	65	75
Season	Spring	43	17.186	20.6574	3.1502	1	120	4	5	10	20	33	45	120	120
Season	Summer	28	24	25.4675	4.8129	5	128	5	10	15	32.5	45	67	128	128
Season	Fall	25	12.68	9.8815	1.9763	1	45	4	5	10	15	20	35	45	45
Asthma	No	139	18.7698	18.7788	1.5928	1	128	3	10	15	20	40	45	75	120
Asthma	Yes	10	20	20.5372	6.4944	4	65	4	5	12	30	55	65	65	65
Asthma	DK	2	7.5	3.5355	2.5	5	10	5	5	7.5	10	10	10	10	10
Angina	No	151	18.702	18.7513	1.526	1	128	4	7	15	20	40	45	67	120
Bronchitis/Emphysema	No	145	18.6552	18.969	1.5753	1	128	4	6	15	20	40	45	75	120
Bronchitis/Emphysema	Yes	6	19.8333	13.5561	5.5342	9	45	9	10	16	23	45	45	45	45

Note: A "\*" Signifies missing data. "DK" = The respondent replied "don't know". Refused = Refused data. N = doer sample size. Mean = Mean 24-hour cumulative number of minutes for doers. Stdev = standard deviation. Stderr = standard error. Min = minimum number of minutes. Max = maximum number of minutes. Percentiles are the percentage of doers below or equal to a given number of minutes.  
Source: Tsang and Klepeis, 1996.



Table 15-129. Statistics for 24-Hour Cumulative Number of Minutes Spent Traveling on a Train/Subway/Rapid Transit

Group Name	Group Code	N	Mean	Stdev	Stderr	Min	Max	Percentiles							
								5	25	50	75	90	95	98	99
All		116	97.767	136.346	12.659	1	810	5	27.5	60	120	189	415	690	720
Gender	Male	62	91.613	119.437	15.168	5	720	10	24	60	120	180	240	480	720
Gender	Female	54	104.833	154.349	21.004	1	810	2	30	60	120	195	480	690	810
Age (years)	*	8	191.875	256.82	90.8	20	810	20	55	117.5	180	810	810	810	810
Age (years)	1-4	2	92.5	38.891	27.5	65	120	65	65	92.5	120	120	120	120	120
Age (years)	5-11	3	166.667	271.401	156.693	5	480	5	5	15	480	480	480	480	480
Age (years)	12-17	2	100	56.569	40	60	140	60	60	100	140	140	140	140	140
Age (years)	18-64	92	84.967	106.533	11.107	1	720	5	30	60	104.5	175	240	480	720
Age (years)	> 64	9	122.667	219.531	73.177	10	690	10	10	24	120	690	690	690	690
Race	White	64	89.5	139.691	17.461	1	720	5	22	55	74	195	380	690	720
Race	Black	26	131.385	168.356	33.017	5	810	10	35	117.5	135	195	480	810	810
Race	Asian	3	79.667	17.039	9.838	60	90	60	60	89	90	90	90	90	90
Race	Some Others	4	71.25	47.675	23.838	30	140	30	42.5	57.5	100	140	140	140	140
Race	Hispanic	16	88.625	98.922	24.731	5	415	5	20	70	112.5	165	415	415	415
Race	Refused	3	85	56.347	32.532	20	120	20	20	115	120	120	120	120	120
Hispanic	No	89	101.281	149.687	15.867	1	810	5	25	60	120	195	480	720	810
Hispanic	Yes	22	86.955	85.561	18.242	5	415	10	40	70	120	130	165	415	415
Hispanic	DK	2	79.5	34.648	24.5	55	104	55	55	79.5	104	104	104	104	104
Hispanic	Refused	3	85	56.347	32.532	20	120	20	20	115	120	120	120	120	120
Employment	*	7	126.429	163.598	61.834	5	480	5	15	65	140	480	480	480	480
Employment	Full Time	76	98.526	128.056	14.689	1	720	5	30	60	120	189	380	690	720
Employment	Part Time	10	61.7	46.375	14.665	5	160	5	15	57.5	89	125	160	160	160
Employment	Not Employed	21	101.714	186.201	40.632	1	810	10	10	55	90	165	415	810	810
Employment	Refused	2	107.5	123.744	87.5	20	195	20	20	107.5	195	195	195	195	195
Education	*	10	122	140.024	44.279	5	480	5	20	92.5	140	337.5	480	480	480
Education	< High School	6	181.833	311.76	127.275	1	810	1	5	70	135	810	810	810	810
Education	High School Graduate	30	89.433	109.191	19.935	1	480	2	30	60	120	177.5	415	480	480
Education	< College	26	125.692	189.64	37.192	10	720	10	20	60	120	380	690	720	720
Education	College Graduate	24	66.5	50.332	10.274	5	180	10	24.5	55	102.5	125	175	180	180
Education	Post Graduate	20	74.15	59.415	13.286	10	240	12.5	30	60	97	164.5	214.5	240	240
Census Region	Northeast	72	111.847	134.554	15.857	10	810	20	49	62.5	122.5	189	415	690	810
Census Region	Midwest	14	64.214	109.483	29.261	2	380	2	10	22.5	50	240	380	380	380
Census Region	South	15	75.733	121.139	31.278	1	480	1	10	30	90	160	480	480	480
Census Region	West	15	83.533	179.444	46.332	5	720	5	10	30	75	120	720	720	720
Day Of Week	Weekday	96	101.604	127.189	12.981	1	720	10	30	60	120	195	415	690	720
Day Of Week	Weekend	20	79.35	176.643	39.499	2	810	3.5	7.5	32.5	60	120	465	810	810
Season	Winter	26	138.192	196.327	38.503	5	810	10	30	79.5	130	240	720	810	810
Season	Spring	29	77.276	89.479	16.616	2	480	5	25	60	105	135	175	480	480
Season	Summer	37	106.081	140.735	23.137	5	690	10	30	60	120	195	480	690	690
Season	Fall	24	65.917	82.217	16.782	1	380	1	15	42.5	82.5	160	180	380	380
Asthma	No	106	94.151	122.865	11.934	1	720	5	30	60	120	180	380	480	690
Asthma	Yes	7	146.571	294.036	111.135	1	810	1	10	30	90	810	810	810	810
Asthma	DK	3	111.667	87.797	50.69	20	195	20	20	120	195	195	195	195	195
Angina	No	112	96.527	137.946	13.035	1	810	5	27.5	60	117.5	175	415	690	720
Angina	DK	4	132.5	82.916	41.458	20	195	20	70	157.5	195	195	195	195	195
Bronchitis/Emphysema	No	112	98.179	138.009	13.041	1	810	5	30	60	120	180	415	690	720
Bronchitis/Emphysema	Yes	1	10	*	*	10	10	10	10	10	10	10	10	10	10
Bronchitis/Emphysema	DK	3	111.667	87.797	50.69	20	195	20	20	120	195	195	195	195	195

Note: A "\*" Signifies missing data. "DK" = The respondent replied "don't know". Refused = Refused data. N = doer sample size. Mean = Mean 24-hour cumulative number of minutes for doers. Stdev = standard deviation. Stderr = standard error. Min = minimum number of minutes. Max = maximum number of minutes. Percentiles are the percentage of doers below or equal to a given number of minutes.  
Source: Tsang and Klepeis, 1996.



Table 15-130. Statistics for 24-Hour Cumulative Number of Minutes Spent Traveling on an Airplane

Group Name	Group Code	N	Mean	Stdev	Stderr	Min	Max	Percentiles									
								5	25	50	75	90	95	98	99		
All		53	234	203.736	27.985	10	900	15	70	210	300	480	660	900	900		
Gender	Male	28	241.25	230.979	43.651	15	900	20	65	210	292.5	555	900	900	900		
Gender	Female	25	225.88	172.581	34.516	10	660	15	110	210	300	480	510	660	660		
Age (years)	*	3	175	145.688	84.113	15	300	15	15	210	300	300	300	300	300		
Age (years)	12-17	3	113.333	118.568	68.455	15	245	15	15	80	245	245	245	245	245		
Age (years)	18-64	42	226.429	193.962	29.929	10	900	20	60	202.5	300	480	555	900	900		
Age (years)	> 64	5	405.4	292.392	130.762	195	900	195	210	287	435	900	900	900	900		
Race	White	44	241.068	215.555	32.496	10	900	15	65	210	300	510	660	900	900		
Race	Black	7	199.286	134.364	50.785	15	435	15	110	210	255	435	435	435	435		
Race	Asian	1	60	*	*	60	60	60	60	60	60	60	60	60	60		
Race	Hispanic	1	340	*	*	340	340	340	340	340	340	340	340	340	340		
Hispanic	No	51	234.745	206.224	28.877	10	900	15	60	210	300	480	660	900	900		
Hispanic	Yes	2	215	176.777	125	90	340	90	90	215	340	340	340	340	340		
Employment	*	3	113.333	118.568	68.455	15	245	15	15	80	245	245	245	245	245		
Employment	Full Time	33	212.424	194.008	33.773	15	900	20	60	180	285	480	555	900	900		
Employment	Part Time	3	510	375.899	217.025	150	900	150	150	480	900	900	900	900	900		
Employment	Not Employed	13	259.385	168.387	46.702	10	660	10	195	225	300	435	660	660	660		
Employment	Refused	1	150	*	*	150	150	150	150	150	150	150	150	150	150		
Education	*	4	122.5	98.531	49.265	15	245	15	47.5	115	197.5	245	245	245	245		
Education	< High School	4	111.25	179.647	89.823	10	380	10	12.5	27.5	210	380	380	380	380		
Education	High School Graduate	9	253.889	191.046	63.682	15	660	15	195	270	285	660	660	660	660		
Education	< College	13	293.846	170.784	47.367	20	555	20	180	300	435	510	555	555	555		
Education	College Graduate	15	194.8	113.998	29.434	45	480	45	90	210	255	287	480	480	480		
Education	Post Graduate	8	305	375.129	132.628	20	900	20	45	137.5	577.5	900	900	900	900		
Census Region	Northeast	17	254.706	234.81	56.95	15	900	15	70	245	380	510	900	900	900		
Census Region	Midwest	17	235.118	234.348	56.838	15	900	15	60	195	287	660	900	900	900		
Census Region	South	9	212.778	103.565	34.522	15	340	15	150	255	270	340	340	340	340		
Census Region	West	10	216	181.702	57.459	10	555	10	45	202.5	240	517.5	555	555	555		
Day Of Week	Weekday	37	258.919	192.755	31.689	15	900	15	150	230	305	510	660	900	900		
Day Of Week	Weekend	16	176.375	222.825	55.706	10	900	10	37.5	95	262.5	360	900	900	900		
Season	Winter	17	216.294	172.818	41.914	20	660	20	60	210	275	480	660	660	660		
Season	Spring	14	191.786	160.547	42.908	15	555	15	90	150	230	435	555	555	555		
Season	Summer	17	230.882	222.171	53.884	10	900	10	60	245	300	480	900	900	900		
Season	Fall	5	423	294.398	131.659	180	900	180	240	285	510	900	900	900	900		
Asthma	No	51	224.843	201.484	28.213	10	900	15	60	210	287	480	660	900	900		
Asthma	Yes	2	467.5	123.744	87.5	380	555	380	380	467.5	555	555	555	555	555		
Angina	No	51	233.725	207.562	29.064	10	900	15	60	210	300	480	660	900	900		
Angina	Yes	2	241	65.054	46	195	287	195	195	241	287	287	287	287	287		
Bronchitis/Emphysema	No	51	231.608	206.7	28.944	10	900	15	60	210	300	480	660	900	900		
Bronchitis/Emphysema	Yes	2	295	120.208	85	210	380	210	210	295	380	380	380	380	380		

Note: A "\*" Signifies missing data. Refused = Refused data. N = doer sample size. Mean = Mean 24-hour cumulative number of minutes for doers. Stdev = standard deviation. Stderr = standard error. Min = minimum number of minutes. Max = maximum number of minutes. Percentiles are the percentage of doers below or equal to a given number of minutes.  
Source: Tsang and Klepeis, 1996.



Table 15-131. Statistics for 24-Hour Cumulative Number of Minutes Spent Indoors in a Residence (all rooms)

Category	Population Group	N	Mean	Stdev	Stderr	Min	Max	Percentiles							
								5	25	50	75	90	95	98	99
All		9343	1001.39	275.143	2.8465	8	1440	575	795	985	1235	1395	1440	1440	1440
Gender	Male	4269	945.9	273.498	4.1859	8	1440	540	750	900	1160	1350	1430	1440	1440
Gender	Female	5070	1048.07	267.864	3.7619	30	1440	620	840	1050	1280	1420	1440	1440	1440
Gender	Refused	4	1060	135.647	67.8233	900	1200	900	950	1070	1170	1200	1200	1200	1200
Age (years)	*	187	1001.07	279.866	20.4658	265	1440	565	799	955	1230	1440	1440	1440	1440
Age (years)	1-4	498	1211.64	218.745	9.8022	270	1440	795	1065	1260	1410	1440	1440	1440	1440
Age (years)	5-11	700	1005.13	222.335	8.4035	190	1440	686	845	975	1165	1334	1412.5	1440	1440
Age (years)	12-17	588	969.5	241.776	9.9707	95	1440	585	811.5	950	1155	1310	1405	1440	1440
Age (years)	18-64	6022	947.91	273.033	3.5184	8	1440	540	750	900	1165	1350	1428	1440	1440
Age (years)	> 64	1348	1174.64	229.344	6.2466	60	1440	760	1030	1210	1375	1440	1440	1440	1440
Race	White	7556	999.36	275.678	3.1714	8	1440	570	795	980	1235	1395	1440	1440	1440
Race	Black	941	1015.95	272.54	8.8845	190	1440	600	815	1000	1245	1410	1440	1440	1440
Race	Asian	157	983.52	254.689	20.3264	30	1440	600	810	930	1180	1355	1420	1440	1440
Race	Some Others	181	996.09	268.283	19.9413	10	1440	604	805	975	1198	1380	1440	1440	1440
Race	Hispanic	382	1009.4	281.75	14.4156	55	1440	555	810	1004.5	1250	1410	1440	1440	1440
Race	Refused	126	1019.69	276.578	24.6396	270	1440	575	840	975	1255	1440	1440	1440	1440
Hispanic	No	8498	1000.38	275.436	2.9879	8	1440	575	795	980	1235	1395	1440	1440	1440
Hispanic	Yes	696	1009.84	270.816	10.2653	55	1440	585	810	1000	1230	1405	1440	1440	1440
Hispanic	DK	46	1097.87	286.655	42.265	401	1440	645	835	1172.5	1355	1440	1440	1440	1440
Hispanic	Refused	103	984.08	269.485	26.5531	270	1440	565	810	950	1200	1375	1440	1440	1440
Employment	*	1768	1053.3	248.46	5.909	95	1440	675	870	1030	1255	1413	1440	1440	1440
Employment	Full Time	4068	881.03	259.166	4.0634	8	1440	515	715	835	1045.5	1290	1385	1440	1440
Employment	Part Time	797	982.44	243.085	8.6105	255	1440	600	820	970	1170	1320	1380	1440	1440
Employment	Not Employed	2639	1158.03	233.775	4.5507	60	1440	735	1015	1190	1350	1440	1440	1440	1440
Employment	Refused	71	995.08	268.059	31.8128	445	1440	575	810	940	1255	1440	1440	1440	1440
Education	*	1963	1044.47	251.888	5.6852	95	1440	660	855	1020	1254	1410	1440	1440	1440
Education	< High School	829	1093.37	278.592	9.6759	150	1440	630	870	1130	1345	1440	1440	1440	1440
Education	High School Graduate	2602	1008.1	279.281	5.4751	30	1440	565	803	995	1245	1400	1440	1440	1440
Education	< College	1788	974.34	272.599	6.4468	10	1440	570	775	930	1205	1371	1436	1440	1440
Education	College Graduate	1240	939.49	275.004	7.8096	30	1440	528	745	885	1165	1335	1427.5	1440	1440
Education	Post Graduate	921	943.67	274.27	9.0375	8	1440	540	750	900	1155	1350	1410	1440	1440
Census Region	Northeast	2068	1003.4	278.441	6.1229	30	1440	570	795	980	1245	1405	1440	1440	1440
Census Region	Midwest	2087	1001.73	280.646	6.1432	8	1440	565	790	989	1250	1390	1440	1440	1440
Census Region	South	3230	999	270.19	4.7541	10	1440	585	800	970	1228	1400	1440	1440	1440
Census Region	West	1958	1002.84	273.992	6.192	30	1440	575	800	1000	1230	1390	1440	1440	1440
Day Of Week	Weekday	6286	965.69	272.596	3.4382	30	1440	567	770	911	1190	1380	1440	1440	1440
Day Of Week	Weekend	3057	1074.81	265.676	4.8051	8	1440	615	895	1105	1290	1420	1440	1440	1440
Season	Winter	2513	1034.92	278.237	5.5503	30	1440	590	825	1015	1285	1432	1440	1440	1440
Season	Spring	2424	977.88	267.177	5.4267	10	1440	580	780	955	1185	1370	1435	1440	1440
Season	Summer	2522	980.52	273.962	5.4553	8	1440	555	785	960	1201	1365	1440	1440	1440
Season	Fall	1884	1014.84	277.47	6.3926	30	1440	589	805	997	1260	1405	1440	1440	1440
Asthma	No	8591	999.12	274.377	2.9602	8	1440	576	795	980	1230	1393	1440	1440	1440
Asthma	Yes	689	1027.42	284.437	10.8362	190	1440	555	825	1025	1260	1430	1440	1440	1440
Asthma	DK	63	1025.68	264.342	33.3039	445	1440	630	840	960	1315	1410	1440	1440	1440
Angina	No	9019	997.77	274.112	2.8863	8	1440	575	795	975	1230	1391	1440	1440	1440
Angina	Yes	249	1125.47	281.353	17.83	180	1440	660	925	1185	1380	1440	1440	1440	1440
Angina	DK	75	1024.08	285.059	32.9158	150	1440	560	840	975	1305	1425	1440	1440	1440
Bronchitis/Emphysema	No	8840	997.66	274.78	2.9225	8	1440	575	795	975	1230	1395	1440	1440	1440
Bronchitis/Emphysema	Yes	432	1070.48	273.759	13.1712	205	1440	585	867.5	1110	1292.5	1440	1440	1440	1440
Bronchitis/Emphysema	DK	71	1045.48	273.047	32.4047	445	1440	565	845	975	1320	1440	1440	1440	1440

Note: A "\*" Signifies missing data. "DK" = The respondent replied "don't know". Refused = Refused data. N = doer sample size. Mean = Mean 24-hour cumulative number of minutes for doers. Stdev = standard deviation. Stderr = standard error. Min = minimum number of minutes. Max = maximum number of minutes. Percentiles are the percentage of doers below or equal to a given number of minutes.  
Source: Tsang and Klepeis, 1996.



Table 15-132. Statistics for 24-Hour Cumulative Number of Minutes Spent Outdoors (outside the residence)

Group Name	Group Code	N	Mean	Stdev	Stderr	Min	Max	Percentiles							
								5	25	50	75	90	95	98	99
All		3124	154.03	158.302	2.8322	1	1290	5	40	105	210	362	480	610	715
Gender	Male	1533	174.908	173.671	4.4356	1	1290	10	60	120	240	420	540	680	745
Gender	Female	1588	133.524	138.801	3.4831	1	1065	5	30	90	190	325	415	525	610
Gender	Refused	3	340	140	80.829	240	500	240	240	280	500	500	500	500	500
Age (years)	*	40	163.95	179.615	28.3996	2	720	3.5	40	107.5	212.5	430	600	720	720
Age (years)	1-4	201	195.652	163.732	11.5488	3	715	30	75	135	270	430	535	625	699
Age (years)	5-11	353	187.564	158.575	8.4401	4	1250	20	80	150	265	365	479	600	720
Age (years)	12-17	219	135.26	137.031	9.2597	1	720	5	35	100	190	300	452	545	610
Age (years)	18-64	1809	144.244	155.13	3.6473	1	1080	5	30	90	199	360	470	600	715
Age (years)	> 64	502	156.448	168.259	7.5098	1	1290	5	36	110	210	375	485	645	735
Race	White	2622	156.787	160.173	3.1281	1	1290	5	45	105	215	375	485	625	720
Race	Black	255	141.557	153.169	9.5918	1	1250	5	30	95	195	330	420	535	645
Race	Asian	34	115.765	135.554	23.2474	1	480	5	20	60	150	360	450	480	480
Race	Some Others	53	167	149.049	20.4735	3	750	5	60	130	238	320	475	553	750
Race	Hispanic	125	117.28	128.886	11.5279	1	720	5	30	70	150	270	355	590	610
Race	Refused	35	187.143	163.771	27.6824	5	600	5	60	170	240	450	510	600	600
Hispanic	No	2857	153.812	158.38	2.9631	1	1290	5	40	105	210	362	480	610	720
Hispanic	Yes	222	146.405	156.069	10.3405	1	750	5	30	112.5	200	345	480	640	690
Hispanic	DK	15	191.533	178.278	46.0312	15	585	15	40	140	380	420	585	585	585
Hispanic	Refused	30	212.5	165.335	30.186	5	600	5	60	180	345	457.5	510	600	600
Employment	*	774	175.762	156.127	5.6119	1	1250	15	60	125	245	380	480	610	705
Employment	Full Time	1110	141.308	159.947	4.8008	1	1080	5	30	85	195	358.5	490	660	745
Employment	Part Time	240	134.663	140.78	9.0873	1	1080	5	30	90	182.5	332.5	422.5	485	525
Employment	Not Employed	978	156.052	159.151	5.0891	1	1290	5	40	115	220	375	480	610	701
Employment	Refused	22	152.727	209.828	44.7355	5	660	5	15	60	125	555	600	660	660
Education	*	825	174.105	156.184	5.4376	1	1250	15	60	125	240	380	480	610	699
Education	< High School	306	171.941	188.396	10.7699	1	1290	7	45	120	240	405	510	765	855
Education	High School Graduate	837	153.633	154.781	5.35	1	840	5	35	105	215	380	480	598	701
Education	< College	527	143.362	157.106	6.8436	1	1080	5	30	90	195	360	465	615	720
Education	College Graduate	355	126.868	142.575	7.5671	1	750	5	30	80	170	300	415	615	690
Education	Post Graduate	274	130.504	150.996	9.122	1	1065	5	30	75	180	325	465	570	660
Census Region	Northeast	635	147.967	143.678	5.7017	1	750	5	35	105	215	345	450	575	610
Census Region	Midwest	639	156.028	169.151	6.6915	1	1290	5	45	102	210	360	500	655	750
Census Region	South	1120	158.577	165.201	4.9363	1	1080	5	40	110	210	390	495	640	745
Census Region	West	730	150.579	149.63	5.5381	1	855	5	36	105	213	360	465	575	660
Day Of Week	Weekday	1933	141.157	148.958	3.388	1	1250	5	31	90	190	345	452	598	698
Day Of Week	Weekend	1191	174.924	170.399	4.9375	1	1290	10	50	120	260	400	500	660	745
Season	Winter	548	113.96	138.121	5.9002	1	1080	5	25	60	150	280	380	540	690
Season	Spring	1034	171.915	159.391	4.9568	1	990	10	60	120	240	390	495	645	730
Season	Summer	1098	168.309	168.2	5.076	1	1290	5	50	120	235	400	510	630	715
Season	Fall	444	126.525	140.747	6.6796	1	960	5	30	75	162.5	313	420	575	655
Asthma	No	2869	154.516	159.172	2.9717	1	1290	5	40	105	210	365	480	615	720
Asthma	Yes	236	145.835	145.523	9.4727	1	885	5	45	105	190	360	450	575	610
Asthma	DK	19	182.421	181.024	41.5298	1	600	1	60	120	300	480	600	600	600
Angina	No	3023	153.218	156.257	2.842	1	1290	5	40	105	210	360	479	610	707
Angina	Yes	76	172.855	222.319	25.5017	2	1080	5	30	68.5	252.5	465	660	1065	1080
Angina	DK	25	195	170.434	34.0869	5	600	5	60	150	300	465	480	600	600
Bronchitis/Emphysema	No	2968	154.884	158.787	2.9146	1	1290	5	40	105	210	367	480	615	715
Bronchitis/Emphysema	Yes	139	129.353	142.494	12.0862	1	855	5	30	75	175	327	415	553	735
Bronchitis/Emphysema	DK	17	206.765	179.765	43.5994	5	600	5	60	170	300	480	600	600	600

Note: A "\*" Signifies missing data. "DK" = The respondent replied "don't know". Refused = Refused data. N = doer sample size. Mean = Mean 24-hour cumulative number of minutes for doers. Stdev = standard deviation. Stderr = standard error. Min = minimum number of minutes. Max = maximum number of minutes. Percentiles are the percentage of doers below or equal to a given number of minutes.  
Source: Tsang and Klepeis, 1996.



Table 15-133. Statistics for 24-Hour Cumulative Number of Minutes Spent Traveling Inside a Vehicle

Category	Population Group	N	Mean	Stdev	Stderr	Min	Max	Percentiles								
								5	25	50	75	90	95	98	99	
All		7743	97.278	104.938	1.1926	1	1440	12	40	70	120	190	270	425	570	
Gender	Male	3603	103.696	119.736	1.9948	1	1440	10	40	70	120	205	295	478	655	
Gender	Female	4138	91.721	89.756	1.3953	1	995	12	40	70	115	180	240	385	465	
Gender	Refused	2	30	14.142	10	20	40	20	20	30	40	40	40	40	40	
Age (years)	*	144	117.035	129.103	10.7586	5	810	20	40	80	142.5	210	435	593	660	
Age (years)	1-4	335	68.116	75.531	4.1267	1	955	10	30	47	85	150	200	245	270	
Age (years)	5-11	571	71.033	77.62	3.2483	1	900	10	25	51	90	140	171	275	360	
Age (years)	12-17	500	81.53	79.8	3.5687	1	790	10	30	60	100	165.5	232.5	345	405	
Age (years)	18-64	5286	104.011	111.1	1.5281	1	1440	15	43	75	120	200	285	450	620	
Age (years)	> 64	907	90.87	93.881	3.1173	4	900	10	35	60	120	190	258	400	460	
Race	White	6288	97.248	107.173	1.3515	1	1440	10	40	70	120	190	270	425	595	
Race	Black	766	98.723	91.337	3.3001	2	810	15	45	75	120	195	265	390	485	
Race	Asian	133	83.414	74.929	6.4972	5	540	20	35	70	105	150	210	330	360	
Race	Some Others	144	96.181	93.965	7.8304	3	690	10	40	69.5	127.5	180	250	345	540	
Race	Hispanic	319	101.734	110.376	6.1799	2	825	20	41	70	120	190	335	465	620	
Race	Refused	93	93.591	90.073	9.3401	10	480	15	30	65	120	205	255	420	480	
Hispanic	No	7050	97.149	104.847	1.2487	1	1440	10	40	70	120	190	270	420	566	
Hispanic	Yes	578	100.043	109.048	4.5358	2	825	15	40	70	120	190	285	480	630	
Hispanic	DK	34	73	68.279	11.7098	5	325	6	25	60	97	175	200	325	325	
Hispanic	Refused	81	98.914	95.273	10.5859	10	480	15	30	65	130	220	255	420	480	
Employment	*	1388	73.609	77.782	2.0878	1	955	10	30	55	90	150	195	275	382	
Employment	Full Time	3732	105.816	116.18	1.9018	4	1440	16	45	75	124	198	290	475	660	
Employment	Part Time	720	98.763	94.999	3.5404	2	960	10	45	75	120	195	260	380	470	
Employment	Not Employed	1849	96.561	99.534	2.3147	1	995	10	37	65	120	200	275	420	526	
Employment	Refused	54	120.296	108.615	14.7807	10	480	20	35	88	190	290	330	390	480	
Education	*	1550	76.39	78.923	2.0047	1	955	10	30	60	95	155	201	302.5	385	
Education	< High School	561	100.822	120.246	5.0768	5	1440	15	40	70	120	180	265	460	620	
Education	High School Graduate	2166	101.605	107.594	2.3118	1	1210	12	40	70	120	210	286	445	570	
Education	< College	1556	103.215	110.128	2.7919	2	1280	15	40	75	120	195	285	460	630	
Education	College Graduate	1108	104.532	109.485	3.2891	4	1215	15	45	75	125	200	280	450	675	
Education	Post Graduate	802	101.938	108.688	3.8379	4	1357	20	45	75.5	120	195	270	365	480	
Census Region	Northeast	1662	98.585	106.64	2.6158	1	1215	15	40	70	120	190	275	425	570	
Census Region	Midwest	1759	101.229	114.641	2.7334	1	1440	10	40	70	120	205	290	435	595	
Census Region	South	2704	96.051	97.72	1.8792	1	955	13	40	70	120	190	250	420	558	
Census Region	West	1618	93.689	103.717	2.5785	2	1280	10	35	65	115	180	260	420	540	
Day Of Week	Weekday	5289	94.437	101.435	1.3948	1	1215	10	40	66	115	180	260	435	575	
Day Of Week	Weekend	2454	103.399	111.892	2.2587	1	1440	13	40	75	125	205	280	420	540	
Season	Winter	2037	94.31	101.375	2.2461	1	1080	10	35	65	116	190	270	425	544	
Season	Spring	2032	99.612	110.464	2.4505	1	1440	12	40	70	120	200	275	440	546	
Season	Summer	2090	97.792	103.76	2.2696	1	1357	10	40	70	120	190	260	415	558	
Season	Fall	1584	97.419	103.714	2.6059	1	1280	14	40	70	120	180	265	420	620	
Asthma	No	7152	97.262	104.554	1.2363	1	1440	10	40	70	120	190	270	425	570	
Asthma	Yes	544	97.241	110.792	4.7502	4	955	17	40	65	116.5	180	255	460	705	
Asthma	DK	47	100	95.192	13.8852	10	480	10	30	75	120	220	239	480	480	
Angina	No	7516	97.288	105.235	1.2139	1	1440	11	40	70	120	190	270	425	570	
Angina	Yes	172	93.07	93.142	7.102	8	615	15	30	65	120	185	280	420	540	
Angina	DK	55	108.945	99.695	13.4429	10	480	20	35	75	150	235	360	390	480	
Bronchitis/Emphysema	No	7349	97.559	106.055	1.2371	1	1440	10	40	70	120	190	270	425	580	
Bronchitis/Emphysema	Yes	342	90.971	79.287	4.2873	2	505	15	40	70	115	195	240	325	460	
Bronchitis/Emphysema	DK	52	98.942	93.767	13.0031	5	480	10	30	73.5	145	195	239	390	480	

Note: A "\*" Signifies missing data. "DK" = The respondent replied "don't know". Refused = Refused data. N = doer sample size. Mean = Mean 24-hour cumulative number of minutes for doers. Stdev = standard deviation. Stderr = standard error. Min = minimum number of minutes. Max = maximum number of minutes. Percentiles are the percentage of doers below or equal to a given number of minutes.  
Source: Tsang and Klepeis, 1996.



Table 15-134. Statistics for 24-Hour Cumulative Number of Minutes Spent Outdoors Near a Vehicle

Category	Population Group	N	Mean	Stdev	Stderr	Min	Max	Percentiles								
								5	25	50	75	90	95	98	99	
All		2825	79.828	143.82	2.7059	1	1440	2	10	30	65	200	465	600	675	
Gender	Male	1388	111.21	184.96	4.9645	1	1440	3	11	30.5	90	430	570	675	735	
Gender	Female	1436	49.541	75.947	2.0042	1	790	2	10	25	60	120	180	290	420	
Gender	Refused	1	20	*	*	20	20	20	20	20	20	20	20	20	20	
Age (years)	*	51	64.373	90.949	12.7354	1	510	4	20	40	65	125	290	360	510	
Age (years)	1-4	102	45.99	59.489	5.8903	1	420	2	10	30	60	105	160	192	245	
Age (years)	5-11	230	55.909	86.475	5.702	1	540	2	10	20	60	170	215	360	465	
Age (years)	12-17	313	40.879	55.718	3.1494	1	435	3	10	21	45	100	160	220	260	
Age (years)	18-64	1787	96.365	169.13	4.0009	1	1440	2	10	30	75	325	539	645	720	
Age (years)	> 64	342	57.55	85.255	4.61	1	560	4	10	30	60	120	205	450	510	
Race	White	2275	81.787	148.41	3.1116	1	1440	2	10	30	68	210	480	600	695	
Race	Black	278	78.374	130.69	7.838	1	645	2	10	30	70	190	435	580	600	
Race	Asian	51	42.431	61.693	8.6387	1	405	2	10	28	60	85	120	150	405	
Race	Some Others	50	73.06	113.02	15.9836	1	535	2	15	40	60	167.5	420	492.5	535	
Race	Hispanic	136	55.066	100.19	8.591	1	600	2	10	25	54.5	110	170	525	600	
Race	Refused	35	124.4	186.88	31.5887	4	810	10	20	40	120	360	565	810	810	
Hispanic	No	2552	79.761	142.98	2.8303	1	1440	2	10	30	65	200	457	600	665	
Hispanic	Yes	230	68.091	125.96	8.3058	1	765	2	10	30	60	147.5	410	565	615	
Hispanic	DK	13	185.31	321.29	89.1098	2	985	2	10	25	100	705	985	985	985	
Hispanic	Refused	30	129.83	198.28	36.2	10	810	10	20	40	98	435	585	810	810	
Employment	*	632	46.989	68.827	2.7378	1	540	2	10	23	55	120	180	265	360	
Employment	Full Time	1169	114.86	193.04	5.646	1	1440	2	10	30	90	485	570	690	740	
Employment	Part Time	254	67.118	114.34	7.174	1	795	2	10	30	63	165	280	510	600	
Employment	Not Employed	751	56.792	84.927	3.099	1	690	2	10	30	60	130	210	360	465	
Employment	Refused	19	96.947	185.76	42.616	5	790	5	20	30	90	360	790	790	790	
Education	*	702	47.098	70.151	2.6477	1	540	2	10	24	55	120	180	265	360	
Education	< High School	222	105.76	193.65	12.9967	1	1440	4	10	30	90	365	540	720	735	
Education	High School Graduate	702	113.18	185.75	7.0107	1	1410	2	10	35	90	455	555	665	740	
Education	< College	537	87.927	157.3	6.7878	1	985	2	10	30	70	240	540	635	705	
Education	College Graduate	367	70.905	117.85	6.1515	1	660	2	10	30	68	170	325	565	600	
Education	Post Graduate	295	55.186	86.872	5.0579	1	710	3	10	30	60	120	200	362	560	
Census Region	Northeast	749	75.734	130.56	4.7705	1	985	3	10	30	70	179	375	570	665	
Census Region	Midwest	586	77.445	141.21	5.8332	1	1440	2	10	30	60	210	390	560	645	
Census Region	South	836	86.447	160.31	5.5443	1	1410	2	10	30	61.5	240	525	643	710	
Census Region	West	654	78.19	138.28	5.4072	1	985	2	10	30	65	180	435	570	615	
Day Of Week	Weekday	2018	84.241	155.61	3.4639	1	1440	2	10	30	65	215	515	625	705	
Day Of Week	Weekend	807	68.793	108.2	3.8088	1	705	2	10	30	65	180	310	465	540	
Season	Winter	703	70.91	141.83	5.3492	1	1440	2	10	26	60	160	365	570	643	
Season	Spring	791	80.542	135.48	4.817	1	810	2	10	30	74	215	435	570	645	
Season	Summer	819	84.178	150.3	5.2519	1	985	2	10	30	70	210	510	615	705	
Season	Fall	512	84.01	148.27	6.5525	1	930	2	10	30	70	225	510	600	690	
Asthma	No	2596	80.366	143.21	2.8107	1	1410	2	10	30	65	205	475	600	675	
Asthma	Yes	205	75.088	157.15	10.9756	1	1440	2	10	30	65	160	309	580	690	
Asthma	DK	24	62.083	78.548	16.0335	5	360	5	17.5	35	67.5	98	225	360	360	
Angina	No	2726	79.57	144.32	2.7642	1	1440	2	10	30	65	196	465	600	687	
Angina	Yes	76	92.434	139.38	15.9879	1	570	3	10	35	91	354	465	535	570	
Angina	DK	23	68.696	91.209	19.0183	5	360	10	20	40	75	98	330	360	360	
Bronchitis/Emphysema	No	2684	79.404	142.84	2.7572	1	1440	2	10	30	65	197	465	600	665	
Bronchitis/Emphysema	Yes	115	93.843	175.36	16.3523	1	985	2	10	30	90	225	465	735	985	
Bronchitis/Emphysema	DK	26	61.615	72.201	14.1598	5	360	7	27	40	75	110	180	360	360	

Note: A "\*" Signifies missing data. "DK" = The respondent replied "don't know". Refused = Refused data. N = doer sample size. Mean = Mean 24-hour cumulative number of minutes for doers. Stdev = standard deviation. Stderr = standard error. Min = minimum number of minutes. Max = maximum number of minutes. Percentiles are the percentage of doers below or equal to a given number of minutes.

Source: Tsang and Klepeis, 1996.





Chapter 15 - Activity Factors

Table 15-135. Statistics for 24-Hour Cumulative Number of Minutes Spent Outdoors Other Than Near a Residence or Vehicle Such as Parks, Golf Courses, or Farms

Group Name	Group Code	N	Mean	Stdev	Stderr	Min	Max	Percentiles								
								5	25	50	75	90	95	98	99	
All		1383	200.153	202.665	5.45	1	1440	10	60	130	276	510	600	748	915	
Gender	Male	789	223.482	208.727	7.431	1	1440	20	60	150	315	540	635	765	900	
Gender	Female	593	168.742	189.993	7.802	1	1440	10	40	105	238	420	540	700	930	
Gender	Refused	1	420	*	*	420	420	420	420	420	420	420	420	420	420	
Age (years)	*	19	183.368	160.349	36.787	10	540	10	60	140	220	510	540	540	540	
Age (years)	1-4	54	164.648	177.34	24.133	1	980	10	60	120	175	370	560	630	980	
Age (years)	5-11	159	171.34	177.947	14.112	5	1210	15	55	115	221	405	574	660	725	
Age (years)	12-17	175	156.903	174.411	13.184	5	1065	10	45	100	210	385	570	735	915	
Age (years)	18-64	858	219.425	215.094	7.343	1	1440	10	60	150	310	540	635	780	933	
Age (years)	> 64	118	181.932	180.158	16.585	5	900	20	55	112.5	280	480	570	600	735	
Race	White	1186	202.615	203.396	5.906	1	1440	14	60	134.5	280	510	615	750	930	
Race	Black	81	185.84	195.119	21.68	1	765	5	40	108	240	540	585	690	765	
Race	Asian	20	169.45	189.122	42.289	10	665	10	32.5	95	230	477.5	585	665	665	
Race	Some Others	30	187.5	161.849	29.549	10	560	10	60	120	270	437.5	535	560	560	
Race	Hispanic	57	158.298	203.27	26.924	1	1305	5	30	110	228	370	435	555	1305	
Race	Refused	9	380	250.637	83.546	30	810	30	195	435	540	810	810	810	810	
Hispanic	No	1267	202.593	203.353	5.713	1	1440	10	60	130	280	510	615	748	915	
Hispanic	Yes	103	163.942	185.155	18.244	1	1305	10	30	115	228	400	511	555	555	
Hispanic	DK	4	67.5	59.231	29.616	10	145	10	22.5	57.5	112.5	145	145	145	145	
Hispanic	Refused	9	330	259.459	86.486	30	810	30	140	210	510	810	810	810	810	
Employment	*	383	163.846	176.805	9.034	1	1210	10	51	110	215	385	560	665	915	
Employment	Full Time	555	228.526	219.372	9.312	1	1305	14	60	150	335	545	645	825	955	
Employment	Part Time	126	202.556	211.673	18.857	3	1440	10	60	125	280	510	580	690	700	
Employment	Not Employed	309	191.469	189.268	10.767	1	1440	10	50	125	275	480	565	690	735	
Employment	Refused	10	254	240.899	76.179	30	810	30	105	167.5	280	675	810	810	810	
Education	*	429	163.949	175.476	8.472	1	1210	10	55	115	210	385	560	665	840	
Education	< High School	83	264.482	255.463	28.041	1	1305	30	60	180	480	555	600	1100	1305	
Education	High School Graduate	313	228.613	228.235	12.901	3	1440	10	60	160	310	570	690	855	990	
Education	< College	250	217.984	202.991	12.838	1	1440	10	60	152.5	330	510	555	715	765	
Education	College Graduate	185	207.27	190.178	13.982	1	930	20	60	128	285	505	600	690	795	
Education	Post Graduate	123	163.642	173.04	15.603	1	900	10	45	90	240	385	480	735	780	
Census Region	Northeast	279	196.824	208.372	12.475	1	1305	10	60	130	265	480	590	900	1130	
Census Region	Midwest	309	196.702	211.59	12.037	1	1440	10	50	120	270	510	635	740	900	
Census Region	South	468	198.432	195.071	9.017	1	933	15	60	120	285	510	600	748	825	
Census Region	West	327	208.716	200.465	11.086	1	1440	15	60	150	285	525	580	725	855	
Day Of Week	Weekday	851	183.982	197.931	6.785	1	1440	10	45	119	240	490	585	735	900	
Day Of Week	Weekend	532	226.019	207.598	9	1	1440	20	68.5	155	320	525	630	810	915	
Season	Winter	241	175.676	192.682	12.412	1	1065	10	35	93	253	450	585	750	810	
Season	Spring	412	185.806	174.522	8.598	5	980	15	60	130	240	473	555	665	740	
Season	Summer	508	224.996	220.748	9.794	1	1440	15	60	150	305	540	630	840	990	
Season	Fall	222	196.5	213.598	14.336	1	1130	10	35	120	280	540	600	780	900	
Asthma	No	1283	196.564	196.894	5.497	1	1440	10	60	125	270	495	600	730	855	
Asthma	Yes	93	244.344	263.314	27.304	5	1440	15	60	150	350	530	810	1100	1440	
Asthma	DK	7	270.714	274.415	103.719	30	810	30	60	195	450	810	810	810	810	
Angina	No	1352	199.038	202.274	5.501	1	1440	10	60	130	270	510	600	740	915	
Angina	Yes	25	238.64	205.994	41.199	1	730	5	60	210	340	465	690	730	730	
Angina	DK	6	290.833	275.979	112.668	30	810	30	140	202.5	360	810	810	810	810	
Bronchitis/Emphysema	No	1326	199.761	200.843	5.516	1	1440	10	60	130	275	500	600	735	900	
Bronchitis/Emphysema	Yes	51	206.431	239.756	33.573	5	1100	10	50	110	305	540	700	930	1100	
Bronchitis/Emphysema	DK	6	233.333	294.035	120.039	15	810	15	30	167.5	210	810	810	810	810	

Note: A "\*" Signifies missing data. "DK" = The respondent replied "don't know". Refused = Refused data. N = doer sample size. Mean = Mean 24-hour cumulative number of minutes for doers. Stdev = standard deviation. Stderr = standard error. Min = minimum number of minutes. Max = maximum number of minutes. Percentiles are the percentage of doers below or equal to a given number of minutes.  
Source: Tsang and Klepeis, 1996.



Table 15-136. Statistics for 24-Hour Cumulative Number of Minutes Spent in an Office or Factory

Category	Population Group	N	Mean	Stdev	Stderr	Min	Max	Percentiles									
								5	25	50	75	90	95	98	99		
All		1975	393.972	230.763	5.1926	1	1440	9	180	485	550	630	675	765	818		
Gender	Male	1012	410.816	233.454	7.3386	1	1440	10	225	495	565	645	710	780	855		
Gender	Female	963	376.271	226.676	7.3045	1	855	5	120	480	540	600	645	710	750		
Age (years)	*	49	438.918	232.58	33.2257	10	900	20	299	500	555	675	780	900	900		
Age (years)	1-4	12	31.583	25.639	7.4013	5	90	5	12.5	25	44.5	60	90	90	90		
Age (years)	5-11	14	100.929	155.126	41.4593	2	580	2	10	32.5	178	195	580	580	580		
Age (years)	12-17	19	145.421	181.118	41.5512	1	625	1	10	50	240	510	625	625	625		
Age (years)	18-64	1749	418.971	218.445	5.2233	1	1440	10	273	500	555	630	680	765	818		
Age (years)	> 64	132	145.848	193.973	16.8832	1	705	3	10	40	205	495	540	640	675		
Race	White	1612	387.646	231.968	5.7776	1	1440	6	150	480	550	628	675	750	800		
Race	Black	191	413.911	218	15.7739	1	1037	10	268	485	540	635	720	803	900		
Race	Asian	42	428.024	216.759	33.4466	10	780	30	285	491.5	553	660	745	780	780		
Race	Some Others	28	480.893	200.859	37.9588	40	795	75	347.5	540	582.5	715	780	795	795		
Race	Hispanic	74	394.459	237.847	27.6492	1	840	5	230	492.5	560	645	720	765	840		
Race	Refused	28	482.893	246.079	46.5046	30	997	30	373	532.5	607.5	818	860	997	997		
Hispanic	No	1805	393.453	229.593	5.404	1	1440	10	180	483	550	630	675	755	810		
Hispanic	Yes	138	393.645	238.608	20.3116	1	840	5	180	497.5	560	644	675	765	795		
Hispanic	DK	7	262.571	242.131	91.5168	1	610	1	12	245	540	610	610	610	610		
Hispanic	Refused	25	470.04	258.753	51.7505	17	860	30	311	525	615	810	818	860	860		
Employment	*	43	121.279	177.984	27.1423	1	685	2	10	40	178	307	580	685	685		
Employment	Full Time	1535	455.571	200.299	5.1124	1	1440	15	400	510	570	644	700	775	837		
Employment	Part Time	164	293.03	196.95	15.3792	1	750	10	95	342.5	480	525	555	585	615		
Employment	Not Employed	213	77.643	122.957	8.4249	1	705	3	10	30	90	215	305	570	640		
Employment	Refused	20	449.15	184.813	41.3256	30	675	60	334	522.5	550	645	675	675	675		
Education	*	80	225.1	248.547	27.7884	1	860	3	15	105	470	607.5	675	780	860		
Education	< High School	104	329.548	264.402	25.9267	2	930	5	50.5	388.5	552.5	640	705	765	855		
Education	High School Graduate	631	396.876	228.074	9.0795	1	997	10	210	492	550	615	675	760	800		
Education	< College	462	393.108	228.826	10.6459	1	1440	5	210	480	540	615	660	770	820		
Education	College Graduate	415	437.231	205.198	10.0728	1	900	10	325	510	570	640	690	750	800		
Education	Post Graduate	283	396.883	232.151	13.7999	2	860	5	175	480	565	640	675	780	818		
Census Region	Northeast	465	399.075	226.243	10.4918	1	930	10	215	485	550	625	675	765	840		
Census Region	Midwest	439	389.31	229.075	10.9331	1	997	8	180	480	550	630	670	750	800		
Census Region	South	666	408.637	228.181	8.8418	1	1440	10	225	497.5	555	630	675	760	840		
Census Region	West	405	369.052	240.375	11.9443	1	900	5	95	470	550	630	675	760	800		
Day Of Week	Weekday	1759	406.795	225.173	5.3689	1	997	10	237	495	555	630	675	755	810		
Day Of Week	Weekend	216	289.551	249.076	16.9475	1	1440	3	30	282.5	495	600	670	800	900		
Season	Winter	531	390.716	231.677	10.0539	1	997	10	180	480	550	625	675	755	835		
Season	Spring	470	385.198	240.678	11.1016	1	1440	5	120	480	553	630	695	775	837		
Season	Summer	550	393.524	224.454	9.5708	1	1037	9	200	482.5	540	613.5	675	753	810		
Season	Fall	424	408.358	226.578	11.0036	1	840	10	238.5	500	566.5	640	675	750	770		
Asthma	No	1845	394.976	230.383	5.3635	1	1440	8	185	490	550	630	675	760	810		
Asthma	Yes	114	371.693	231.336	21.6666	3	840	10	120	462.5	540	630	675	800	837		
Asthma	DK	16	437	272.067	68.0168	5	860	5	232.5	520	587.5	780	860	860	860		
Angina	No	1931	395.718	229.668	5.2265	1	1440	10	195	490	550	630	675	760	811		
Angina	Yes	26	265.462	246.766	48.3947	5	650	9	15	175	490	630	645	650	650		
Angina	DK	18	392.333	282.64	66.619	5	860	5	30	490	550	780	860	860	860		
Bronchitis/Emphysema	No	1873	395.611	229.961	5.3135	1	1440	8	195	490	550	630	675	760	818		
Bronchitis/Emphysema	Yes	86	356.43	236.119	25.4614	5	800	10	75	427.5	540	620	660	720	800		
Bronchitis/Emphysema	DK	16	403.875	289.456	72.3641	5	860	5	30	490	582.5	780	860	860	860		

Note: A "\*" Signifies missing data. "DK" = The respondent replied "don't know". Refused = Refused data. N = doer sample size. Mean = Mean 24-hour cumulative number of minutes for doers. Stdev = standard deviation. Stderr = standard error. Min = minimum number of minutes. Max = maximum number of minutes. Percentiles are the percentage of doers below or equal to a given number of minutes. Source: Tsang and Klepeis, 1996.



Table 15-137. Statistics for 24-Hour Cumulative Number of Minutes Spent in Malls, Grocery Stores, or Other Stores

Group Name	Group Code	N	Mean	Stdev	Stderr	Min	Max	Percentiles							
								5	25	50	75	90	95	98	99
All		2697	114.975	140.961	2.7143	1	1080	10	30	60	135	285	482	570	640
Gender	Male	1020	120.159	157.143	4.9203	1	840	5	30	60	130	375	530	609	658
Gender	Female	1677	111.822	130.088	3.1766	1	1080	10	30	60	135	255	400	550	600
Age (years)	*	50	139.44	137.586	19.4576	15	660	20	45	92.5	180	338.5	420	565	660
Age (years)	1-4	110	90.036	77.887	7.4263	5	420	10	40	65	105	210	250	359	360
Age (years)	5-11	129	77.674	68.035	5.9901	3	320	5	30	60	110	180	225	255	280
Age (years)	12-17	140	88.714	101.361	8.5666	1	530	5	20	45	123.5	222.5	317.5	384	413
Age (years)	18-64	1871	125.927	156.815	3.6253	1	1080	10	30	60	150	360	525	600	658
Age (years)	> 64	397	88.572	88.477	4.4405	1	655	10	30	60	120	180	255	400	470
Race	White	2234	111.563	139.443	2.9502	1	1080	10	30	60	130	265	495	570	640
Race	Black	237	123	152.318	9.8941	2	800	10	25	60	135	370	480	600	613
Race	Asian	37	158.892	151.725	24.9434	2	600	14	50	105	220	410	480	600	600
Race	Some Others	52	150.231	146.737	20.3488	5	660	14	65	102.5	180	280	588	600	660
Race	Hispanic	110	133.145	138.309	13.1872	1	720	10	35	90	195	310	450	535	540
Race	Refused	27	124.741	131.136	25.2372	10	515	10	30	60	207	300	380	515	515
Hispanic	No	2476	114.387	141.819	2.8501	1	1080	10	30	60	131.5	285	495	570	640
Hispanic	Yes	188	126.074	133.15	9.711	1	720	10	30	90	172.5	270	450	540	610
Hispanic	DK	12	49.417	37.689	10.8798	2	122	2	17.5	47.5	69.5	105	122	122	122
Hispanic	Refused	21	122.429	138.488	30.2206	10	515	20	33	60	180	290	380	515	515
Employment	*	372	86.946	86.322	4.4756	1	660	5	30	60	120	206	255	360	384
Employment	Full Time	1170	136.797	176.691	5.1656	1	1080	10	30	60	150	480	562	640	690
Employment	Part Time	285	134.123	147.732	8.7509	2	540	6	30	65	186	400	480	520	540
Employment	Not Employed	854	91.198	87.218	2.9846	1	585	10	30	60	120	195	255	360	420
Employment	Refused	16	98.938	110.033	27.5083	10	357	10	31.5	52.5	115	290	357	357	357
Education	*	420	88.262	91.922	4.4853	1	660	5	29	60	120	210	262.5	384	420
Education	< High School	206	128.937	155.722	10.8497	2	1080	10	30	75	150	330	500	570	605
Education	High School Graduate	792	126.295	158.884	5.6457	1	960	5	30	60	150	365	524	600	660
Education	< College	583	129.849	149.53	6.1929	1	800	10	30	70	165	345	510	563	651
Education	College Graduate	411	117.876	144.142	7.11	1	720	10	30	60	135	290	515	600	640
Education	Post Graduate	285	78.182	95.665	5.6667	1	630	10	25	50	90	160	250	450	555
Census Region	Northeast	622	110.201	134.942	5.4107	1	755	5	30	60	130	280	465	563	600
Census Region	Midwest	601	108.243	133.098	5.4292	2	840	10	30	60	130	250	440	560	645
Census Region	South	871	127.922	155.825	5.2799	1	1080	10	30	60	155	320	520	600	660
Census Region	West	603	107.909	130.742	5.3242	1	840	10	30	60	120	255	430	550	600
Day Of Week	Weekday	1721	117.451	148.879	3.5887	1	1080	10	30	60	135	320	510	586	650
Day Of Week	Weekend	976	110.61	125.747	4.0251	1	840	5	30	65	135	255	380	560	608
Season	Winter	683	111.71	134	5.1274	2	840	10	30	60	135	255	420	568	660
Season	Spring	679	115.844	142.21	5.4575	1	720	10	30	60	130	300	500	588	645
Season	Summer	759	113.138	147.47	5.3528	1	1080	5	30	60	125	300	510	570	610
Season	Fall	576	120.243	138.948	5.7895	1	840	10	30	60	160	295	480	550	640
Asthma	No	2480	116.246	142.351	2.8585	1	1080	10	30	60	135	287.5	495	575	640
Asthma	Yes	208	101.111	124.977	8.6656	1	600	5	30	60	120	245	420	545	550
Asthma	DK	9	85.111	79.634	26.5447	33	290	33	55	58	60	290	290	290	290
Angina	No	2607	115.981	142.101	2.7831	1	1080	10	30	60	135	290	495	570	640
Angina	Yes	74	90.838	103.912	12.0795	2	630	15	37	64	105	150	190	510	630
Angina	DK	16	62.688	68.084	17.021	2	290	2	30	55	60	110	290	290	290
Bronchitis/Emphysema	No	2553	115.736	141.704	2.8045	1	1080	10	30	60	135	285	481	570	640
Bronchitis/Emphysema	Yes	130	104.754	131.336	11.5189	5	613	10	25	60	135	192.5	505	575	609
Bronchitis/Emphysema	DK	14	71.143	66.864	17.8701	20	290	20	35	56.5	70	110	290	290	290

Note: A "\*" Signifies missing data. "DK" = The respondent replied "don't know". Refused = Refused data. N = doer sample size. Mean = Mean 24-hour cumulative number of minutes for doers. Stdev = standard deviation. Stderr = standard error. Min = minimum number of minutes. Max = maximum number of minutes. Percentiles are the percentage of doers below or equal to a given number of minutes.

Source: Tsang and Klepeis, 1996.



Table 15-138. Statistics for 24-Hour Cumulative Number of Minutes Spent in Schools, Churches, Hospitals, and Public Buildings

Category	Population Group	N	Mean	Stdev	Stderr	Min	Max	Percentile								
								5	25	50	75	90	95	98	99	
All		2932	274.332	205.942	3.8033	1	1440	20	95	221	430	540	615	725	805	
Gender	Male	1234	285.147	206.713	5.8845	1	1440	30	110	255	425	540	620	745	840	
Gender	Female	1698	266.472	205.082	4.9769	1	1440	20	90	200	430	540	610	713	800	
Age (years)	*	50	268.96	221.042	31.2601	5	1030	30	100	192.5	400	590	625	871.5	1030	
Age (years)	1-4	98	233	235.787	23.8181	1	1440	5	60	150	390	545	595	900	1440	
Age (years)	5-11	391	351.202	149.578	7.5645	5	665	70	245	389	440	535	562	625	645	
Age (years)	12-17	355	366.338	161.247	8.5581	1	935	60	260	415	446	502	605	710	805	
Age (years)	18-64	1653	267.707	221.203	5.4407	1	1440	15	87	190	450	570	655	760	855	
Age (years)	> 64	385	151.091	128.639	6.556	5	710	21	60	115	195	340	435	525	615	
Race	White	2310	268.239	204.323	4.2512	1	1440	20	90	210	429	540	612	705	765	
Race	Black	332	303.473	207.071	11.3645	1	1440	35	135	285	440	540	630	775	1000	
Race	Asian	61	295	199.398	25.5302	5	900	30	135	240	425	535	565	840	900	
Race	Some Others	57	314.684	203.549	26.9607	10	967	30	135	360	455	525	598	820	967	
Race	Hispanic	141	283.936	229.828	19.355	2	1440	11	100	237	430	525	630	840	940	
Race	Refused	31	257.774	192.517	34.5771	5	681	5	120	240	430	495	625	681	681	
Hispanic	No	2654	271.293	203.551	3.9511	1	1440	20	94	215	425	540	612	712	800	
Hispanic	Yes	240	306.388	230.835	14.9003	1	1440	20	110	287.5	444.5	567.5	695	840	940	
Hispanic	DK	13	279.385	230.736	63.9946	35	760	35	65	235	420	562	760	760	760	
Hispanic	Refused	25	286.6	175.367	35.0734	5	625	55	145	255	440	495	565	625	625	
Employment	*	821	343.484	171.113	5.9719	1	1440	55	190	393	441	520	570	645	713	
Employment	Full Time	1029	300.3	239.785	7.4751	1	1440	15	90	215	510	610	685	775	900	
Employment	Part Time	293	251.324	199.326	11.6447	1	1030	20	85	200	387	525	610	800	880	
Employment	Not Employed	775	176.406	148.414	5.3312	1	855	15	60	121	250	400	475	570	641	
Employment	Refused	14	212.857	147.736	39.484	5	440	5	120	190	305	430	440	440	440	
Education	*	917	340.328	172.613	5.7002	1	1440	45	190	390	440	525	580	645	713	
Education	< High School	166	172.602	138.026	10.7129	1	735	27	70	123.5	235	375	465	525	640	
Education	High School Graduate	617	207.29	199.027	8.0125	1	1440	15	60	135	295	510	585	690	785	
Education	< College	520	247.492	213.609	9.3674	1	1000	15	85	165	420	552.5	640	760	855	
Education	College Graduate	351	261.581	214.287	11.4378	1	1005	15	85	180	450	560	625	750	800	
Education	Post Graduate	361	319.114	236.166	12.4298	1	1440	30	110	290	510	615	683	765	900	
Census Region	Northeast	645	272.747	211.594	8.3315	1	1440	25	90	215	420	545	630	735	855	
Census Region	Midwest	686	275.394	207.157	7.9093	1	1440	30	88	239	425	540	615	745	850	
Census Region	South	1036	278.387	201.004	6.2449	1	1440	20	110	230	440	535	600	690	778	
Census Region	West	565	267.418	207.214	8.7176	1	1440	15	100	200	420	555	620	712	820	
Day Of Week	Weekday	2091	309.844	212.577	4.6488	1	1440	15	115	340	460	565	632	750	855	
Day Of Week	Weekend	841	186.039	156.873	5.4094	1	1440	40	85	140	230	385	525	640	735	
Season	Winter	847	296.587	201.244	6.9148	1	1440	30	120	285	444	545	615	710	770	
Season	Spring	805	276.761	204.618	7.2118	1	1440	30	110	220	420	535	600	725	840	
Season	Summer	667	254.115	209.724	8.1205	1	1015	20	80	180	420	550	630	738	890	
Season	Fall	613	262.39	207.33	8.374	1	1005	14	75	210	425	540	615	712	778	
Asthma	No	2689	273.193	207.301	3.9977	1	1440	20	94	217	430	540	615	725	820	
Asthma	Yes	229	287.974	191.578	12.6598	1	855	25	120	275	435	533	605	645	800	
Asthma	DK	14	270	171.24	45.7658	5	565	5	145	280	430	445	565	565	565	
Angina	No	2836	277.127	206.396	3.8757	1	1440	20	100	230	430	540	615	725	805	
Angina	Yes	78	176.423	172.803	19.5661	5	890	28	60	120	195	480	575	625	890	
Angina	DK	18	258.278	165.599	39.0321	3	565	3	145	270	378	480	565	565	565	
Bronchitis/Emphysema	No	2794	276.999	207.348	3.9227	1	1440	20	95	228	430	540	615	726	840	
Bronchitis/Emphysema	Yes	121	212.562	166.349	15.1226	10	662	30	90	145	375	445	490	605	630	
Bronchitis/Emphysema	DK	17	275.765	163.401	39.6306	5	565	5	145	305	415	440	565	565	565	

Note: A "\*" Signifies missing data. "DK" = The respondent replied "don't know". Refused = Refused data. N = doer sample size. Mean = Mean 24-hour cumulative number of minutes for doers. Stdev = standard deviation. Stderr = standard error. Min = minimum number of minutes. Max = maximum number of minutes. Percentiles are the percentage of doers below or equal to a given number of minutes.  
Source: Tsang and Klepeis, 1996.



Table 15-139. Statistics for 24-Hour Cumulative Number of Minutes Spent in Bars/Nightclubs, Bowling Alleys, and Restaurants

Category	Population Group	N	Mean	Stdev	Stderr	Min	Max	Percentiles							
								5	25	50	75	90	95	98	99
All		2296	111.735	131.368	2.7416	1	925	10	40	60	120	255	405	568	660
Gender	Male	1127	109.497	129.654	3.8621	1	900	10	35	60	120	240	377	560	660
Gender	Female	1169	113.892	133.019	3.8905	2	925	10	45	60	120	270	424	570	645
Age (years)	*	32	138.094	151.816	26.8376	15	610	30	47.5	65	150	315	495	610	610
Age (years)	1-4	61	62.705	47.701	6.1075	4	330	10	35	55	85	115	120	130	330
Age (years)	5-11	88	58.602	39.746	4.2369	5	180	10	30	45	85	120	137	170	180
Age (years)	12-17	127	76.614	82.038	7.2797	2	455	10	30	50	90	220	270	325	360
Age (years)	18-64	1718	121.371	142.223	3.4313	1	925	10	40	65	135	285	462	600	680
Age (years)	> 64	270	92.207	90.483	5.5066	3	750	20	45	62.5	100	177.5	255	358	520
Race	White	1945	108.84	127.174	2.8836	1	925	10	40	60	120	240	388	560	645
Race	Black	167	121.88	147.847	11.4408	5	805	10	30	60	153	300	490	555	735
Race	Asian	42	103.976	104.151	16.0709	5	497	30	40	62.5	120	200	240	497	497
Race	Some Others	36	159.333	196.721	32.7868	5	765	10	52.5	90	137.5	495	750	765	765
Race	Hispanic	83	130.205	161.594	17.7373	5	813	15	40	65	143	360	485	700	813
Race	Refused	23	155.913	135.696	28.2945	20	480	30	60	88	270	330	410	480	480
Hispanic	No	2131	110.53	129.679	2.8092	1	925	10	40	60	120	245	395	560	650
Hispanic	Yes	141	127.319	153.659	12.9404	1	813	15	40	70	120	360	440	700	765
Hispanic	DK	7	95	115.109	43.507	5	315	5	10	40	165	315	315	315	315
Hispanic	Refused	17	140.353	147.503	35.7748	30	480	30	40	70	210	410	480	480	480
Employment	*	273	65.85	61.078	3.6966	2	455	10	30	50	85	120	182	273	330
Employment	Full Time	1215	125.765	151.364	4.3424	1	925	10	40	63	135	300	500	640	735
Employment	Part Time	236	144.729	157.886	10.2775	1	813	10	47.5	80	180	385	520	615	745
Employment	Not Employed	559	88.642	77.231	3.2665	3	610	15	45	60	115	180	240	315	388
Employment	Refused	13	158.077	127.157	35.267	30	425	30	70	105	240	330	425	425	425
Education	*	309	76.006	81.68	4.6466	1	548	10	30	55	90	165	255	330	455
Education	< High School	155	154.155	175.537	14.0995	5	925	15	40	90	209	388	545	700	870
Education	High School Graduate	665	119.502	145.414	5.6389	3	910	10	45	60	120	290	485	630	680
Education	< College	498	121.321	137.839	6.1767	2	775	10	40	75	135	270	440	610	675
Education	College Graduate	395	101.096	109.709	5.5201	1	765	15	40	60	120	225	330	507	570
Education	Post Graduate	274	107.091	117.52	7.0997	3	765	15	40	65	120	220	330	560	675
Census Region	Northeast	462	115.771	127.168	5.9164	2	765	15	45	70	120	270	380	560	650
Census Region	Midwest	561	113.688	132.476	5.5932	1	813	10	40	65	120	250	410	570	675
Census Region	South	748	105.619	133.036	4.8643	2	910	13	35	60	110	240	390	555	650
Census Region	West	525	114.81	131.486	5.7385	1	925	10	37	70	130	245	417	590	640
Day Of Week	Weekday	1407	112.164	138.508	3.6926	1	925	10	35	60	120	270	430	595	675
Day Of Week	Weekend	889	111.055	119.269	4.0001	2	870	10	45	70	120	235	351	535	630
Season	Winter	584	116.783	135.982	5.627	3	875	15	40	68.5	120	265	440	595	735
Season	Spring	615	108.416	124.727	5.0295	2	925	15	41	65	120	240	395	542	585
Season	Summer	622	110.543	132.965	5.3314	1	910	10	35	60	120	260	390	605	660
Season	Fall	475	111.385	132.104	6.0614	1	900	10	35	60	125	265	355	550	770
Asthma	No	2124	111.768	129.918	2.819	1	910	10	40	60	120	255	390	568	660
Asthma	Yes	163	107.301	145.813	11.4209	4	925	10	30	57	118	265	485	560	670
Asthma	DK	9	184.222	186.348	62.1159	30	480	30	60	88	300	480	480	480	480
Angina	No	2229	112.481	132.361	2.8035	1	925	10	40	60	120	260	410	570	660
Angina	Yes	54	71.463	52.513	7.1461	3	340	15	45	60	90	120	120	232	340
Angina	DK	13	151	162.726	45.132	30	480	30	35	88	120	480	480	480	480
Bronchitis/Emphysema	No	2171	111.178	129.886	2.7876	1	910	10	40	60	120	255	400	560	660
Bronchitis/Emphysema	Yes	114	109.807	134.998	12.6437	5	925	15	43	65	120	235	375	530	620
Bronchitis/Emphysema	DK	11	241.636	274.085	82.6397	10	875	10	30	88	480	480	875	875	875

Note: A "\*" Signifies missing data. "DK" = The respondent replied "don't know". Refused = Refused data. N = doer sample size. Mean = Mean 24-hour cumulative number of minutes for doers. Stdev = standard deviation. Stderr = standard error. Min = minimum number of minutes. Max = maximum number of minutes. Percentiles are the percentage of doers below or equal to a given number of minutes. Source: Tsang and Klepeis, 1996.



Table 15-140. Statistics for 24-Hour Cumulative Number of Minutes Spent in Other Outdoors  
Such as Auto Repair Shops, Laundromats, Gyms, and at Work (non-specific)

Group Name	Group Code	N	Mean	Stdev	Stdev	Min	Max	Percentiles							
								5	25	50	75	90	95	98	99
All		1214	225.747	231.111	6.633	1	1440	10	56	120	370	568	670	800	910
Gender	Male	612	260.322	239.586	9.685	1	1040	10	60	160	460	605	695	815	930
Gender	Female	602	190.598	216.774	8.835	1	1440	10	45	105	260	535	600	720	855
Age (years)	*	21	264.524	273.733	59.733	15	940	30	75	100	420	560	840	940	940
Age (years)	1-4	27	92.296	74.852	14.405	10	270	15	25	65	160	180	250	270	270
Age (years)	5-11	59	134.678	186.691	24.305	5	910	5	30	80	145	325	720	855	910
Age (years)	12-17	76	164.368	159.542	18.301	1	660	5	45	130	208	450	550	600	660
Age (years)	18-64	903	250.29	243.45	8.101	1	1440	10	60	135	450	600	690	815	945
Age (years)	> 64	128	152.813	159.777	14.122	2	770	12	45	95	202.5	420	510	600	610
Race	White	996	226.348	228.881	7.252	1	1440	10	58.5	120	370	580	665	780	910
Race	Black	118	228.102	256.391	23.603	2	1430	5	45	120	358	525	720	990	1150
Race	Asian	25	194.68	196.484	39.297	5	600	25	58	90	300	525	530	600	600
Race	Some Others	23	211.217	236.332	49.279	5	800	10	25	115	405	515	680	800	800
Race	Hispanic	42	250.19	229.16	35.36	5	793	15	60	165	420	600	675	793	793
Race	Refused	10	146.5	246.555	77.967	15	840	15	55	67.5	105	495	840	840	840
Hispanic	No	1133	224.325	231.063	6.865	1	1440	10	55	120	360	565	670	810	930
Hispanic	Yes	68	230.088	215.421	26.124	5	793	15	61.5	127.5	398	545	660	790	793
Hispanic	DK	5	483.2	240.867	107.719	55	623	55	560	568	610	623	623	623	623
Hispanic	Refused	8	229.375	310.592	109.811	30	840	30	42.5	67.5	372.5	840	840	840	840
Employment	*	162	140.031	158.915	12.486	1	910	10	30	103.5	170	325	505	660	855
Employment	Full Time	652	276.345	250.945	9.828	2	1430	10	60	162.5	508	619	700	815	945
Employment	Part Time	132	240.909	227.902	19.836	5	1440	15	67.5	170	360	510	620	815	1005
Employment	Not Employed	259	145.347	173.086	10.755	1	1150	5	40	90	160	432	540	704	770
Employment	Refused	9	194.444	278.752	92.917	15	840	15	40	75	150	840	840	840	840
Education	*	186	148.097	168.067	12.323	1	910	5	30	109.5	177	330	520	720	855
Education	< High School	88	301.966	251.244	26.783	5	930	15	60	265	487.5	670	780	815	930
Education	High School Graduate	324	249.086	243.136	13.508	2	1150	10	53.5	126	435	595	690	815	979
Education	< College	251	266.996	256.435	16.186	2	1440	10	60	155	480	600	710	800	990
Education	College Graduate	217	202.014	217.284	14.75	1	1005	5	55	110	295	570	645	760	855
Education	Post Graduate	148	191.764	198.819	16.343	2	870	10	60	105	262.5	535	590	700	793
Census Region	Northeast	275	218.171	216.166	13.035	2	990	10	60	120	360	544	660	765	855
Census Region	Midwest	254	250.689	241.492	15.153	1	1005	10	55	150	460	600	695	815	940
Census Region	South	401	223.691	239.929	11.981	1	1440	10	47	120	360	560	635	815	979
Census Region	West	284	213.68	222.324	13.193	2	960	10	60	120	305	585	675	793	850
Day Of Week	Weekday	900	224.954	232.145	7.738	1	1430	10	58.5	120	367.5	565	672.5	815	942.5
Day Of Week	Weekend	314	228.019	228.476	12.894	2	1440	8	52	120	376	580	665	720	815
Season	Winter	347	241.715	239.749	12.87	2	1440	10	60	155	390	585	660	897	960
Season	Spring	321	220.343	220.658	12.316	1	1005	10	54	115	390	550	630	730	815
Season	Summer	294	224.418	244.957	14.286	1	1040	5	45	115	360	595	760	855	979
Season	Fall	252	212.194	214.928	13.539	1	990	15	55.5	120	327.5	540	660	710	793
Asthma	No	1123	225.742	229.228	6.84	1	1440	10	55	125	370	565	660	780	897
Asthma	Yes	84	228.5	259.329	28.295	1	979	10	59.5	100	351	660	793	910	979
Asthma	DK	7	193.571	201.406	76.124	15	510	15	60	80	450	510	510	510	510
Angina	No	1178	225.259	231.28	6.739	1	1440	10	55	120	360	570	670	810	930
Angina	Yes	28	227.75	218.573	41.306	5	770	12	62.5	135	425	560	600	770	770
Angina	DK	8	290.625	269.171	95.166	15	780	15	67.5	217.5	480	780	780	780	780
Bronchitis/Emphysema	No	1166	226.724	232.003	6.794	1	1440	10	58	120	370	570	670	810	930
Bronchitis/Emphysema	Yes	41	198.829	213.198	33.296	5	780	10	45	95	330	550	565	780	780
Bronchitis/Emphysema	DK	7	220.714	197.261	74.558	15	510	15	60	155	450	510	510	510	510

Note: A "\*" Signifies missing data. "DK" = The respondent replied "don't know". Refused = Refused data. N = doer sample size. Mean = Mean 24-hour cumulative number of minutes for doers. Stdev = standard deviation. Stdev = standard error. Min = minimum number of minutes. Max = maximum number of minutes. Percentiles are the percentage of doers below or equal to a given number of minutes.  
Source: Tsang and Klepeis, 1996.



Table 15-141. Statistics for 24-Hour Cumulative Number of Minutes Spent with Smokers Present

Category	Population Group	N	Mean	Stdev	Stdevr	Min	Max	Percentiles							
								5	25	50	75	90	95	98	99
All		4005	381.494	300.479	4.748	1	1440	30	120	319	595	815	925	1060	1170
Gender	Male	1967	411.359	313	7.057	1	1440	30	135	355	638	855	965	1105	1217
Gender	Female	2035	352.771	285.139	6.321	1	1440	29	105	285	545	780	870	995	1110
Gender	Refused	3	283.333	188.171	108.641	105	480	105	105	265	480	480	480	480	480
Age (years)	*	54	386.259	305.371	41.556	5	1440	25	105	370	555	780	995	995	1440
Age (years)	1-4	155	366.561	324.464	26.062	5	1440	30	90	273	570	825	1010	1140	1305
Age (years)	5-11	224	318.071	314.016	20.981	1	1440	25	105	190	475	775	1050	1210	1250
Age (years)	12-17	256	245.77	243.61	15.226	1	1260	10	60	165	360	595	774	864	1020
Age (years)	18-64	2976	403.067	299.434	5.489	2	1440	30	134.5	355	625	830	930	1047	1150
Age (years)	> 64	340	342.694	292.209	15.847	5	1440	30	100	240	540	797.5	880	1015	1205
Race	White	3279	389.219	303.032	5.292	1	1440	30	120	330	610	825	930	1060	1190
Race	Black	395	359.977	287.96	14.489	2	1440	22	118	300	538	775	905	1080	1160
Race	Asian	48	262.063	209.928	30.3	5	800	10	64	212.5	412.5	560	630	800	800
Race	Some Others	79	420.671	339.247	38.168	10	1328	30	135	310	655	885	1140	1305	1328
Race	Hispanic	165	292.624	250.208	19.479	5	1095	15	75	220	475	660	800	845	945
Race	Refused	39	393.538	325.254	52.082	25	1110	30	115	290	655	865	1040	1110	1110
Hispanic	No	3666	384.913	301.22	4.975	1	1440	30	120	324	600	822	930	1060	1170
Hispanic	Yes	288	336.191	280.874	16.551	1	1440	20	115	252	512	760	850	1010	1260
Hispanic	DK	18	369.833	371.484	87.56	15	1440	15	90	220	600	760	1440	1440	1440
Hispanic	Refused	33	403.364	322.819	56.195	25	1110	30	120	325	655	840	1040	1110	1110
Employment	*	624	301.723	295.529	11.831	1	1440	15	75	190	450	735	900	1140	1230
Employment	Full Time	2042	405.894	296.349	6.558	2	1440	30	135	364.5	625	835	925	1005	1110
Employment	Part Time	381	378.013	291.098	14.913	5	1440	30	135	325	585	805	915	1080	1245
Employment	Not Employed	935	383.833	308.691	10.095	3	1440	30	120	310	600	825	930	1110	1290
Employment	Refused	23	341.957	254.245	53.014	25	925	30	120	325	450	715	885	925	925
Education	*	704	308.635	292.801	11.035	1	1440	15	87.5	205	465	741	900	1095	1217
Education	< High School	377	497.719	317.756	16.365	2	1440	40	225	465	775	905	990	1120	1369
Education	High School Graduate	1315	425.682	301.711	8.32	3	1440	30	155	390	650	840	928	1060	1202
Education	< College	829	388.807	295.753	10.272	5	1435	30	135	330	600	810	930	1050	1155
Education	College Graduate	473	325.871	272.694	12.538	2	1140	30	90	240	499	735	860	990	1035
Education	Post Graduate	307	282.518	257.117	14.674	3	1205	20	60	200	430	665	810	900	983
Census Region	Northeast	932	369.46	287.677	9.423	2	1440	30	120	314	565	800	892	990	1095
Census Region	Midwest	938	384.067	304.829	9.953	2	1440	29	120	319.5	600	825	930	1080	1140
Census Region	South	1409	404.028	308.501	8.219	1	1440	30	130	345	630	840	943	1090	1205
Census Region	West	726	349.883	291.992	10.837	1	1440	30	110	274	541	800	900	1045	1180
Day Of Week	Weekday	2661	374.746	296.185	5.742	1	1440	30	120	315	578	810	915	1045	1150
Day Of Week	Weekend	1344	394.854	308.482	8.415	1	1440	30	120	321.5	625	833	940	1110	1260
Season	Winter	1046	374.159	304.183	9.405	1	1440	25	115	295	590	815	925	1080	1170
Season	Spring	1034	384.762	301.561	9.378	2	1440	30	120	320	610	810	900	1105	1215
Season	Summer	1059	385.134	300.394	9.231	2	1440	30	120	330	591	840	940	1040	1130
Season	Fall	866	381.999	295.104	10.028	2	1440	30	120	324	590	810	915	1030	1150
Asthma	No	3687	378.806	298.378	4.914	1	1440	30	120	315	591	810	915	1050	1170
Asthma	Yes	298	416.862	323.967	18.767	5	1440	20	135	342.5	652	870	1015	1202	1335
Asthma	DK	20	350	304.324	68.049	25	995	27.5	60	290	540	795	902.5	995	995
Angina	No	3892	380.923	299.475	4.8	1	1440	30	120	320	595	815	920	1060	1170
Angina	Yes	87	404.31	345.105	36.999	2	1380	30	120	270	703	910	1015	1320	1380
Angina	DK	26	390.577	300.394	58.912	25	995	30	115	342.5	670	780	790	995	995
Bronchitis/Emphysema	No	3749	378.662	298.576	4.876	1	1440	30	120	315	590	810	915	1060	1170
Bronchitis/Emphysema	Yes	236	431.157	326.848	21.276	5	1380	30	150	362.5	680	892	980	1205	1260
Bronchitis/Emphysema	DK	20	326.25	291.068	65.085	10	995	17.5	85	222.5	540	755	887.5	995	995

Note: A "\*" signifies missing data. "DK" = The respondent replied "don't know". Refused = Refused data. N = doer sample size. Mean = Mean 24-hour cumulative number of minutes for doers. Stdev = standard deviation. Stdevr = standard error. Min = minimum number of minutes. Max = maximum number of minutes. Percentiles are the percentage of doers below or equal to a given number of minutes. Source: Tsang and Klepeis, 1996.



Table 15-142 Range of Time (minutes) Spent Smoking Based on the Number of Respondents

	Total N	Number of Minutes											
		*_*	0-60	60-120	120-180	180-240	240-300	300-360	360-420	420-480	480-540	540-600	600-660
<b>Overall</b>	9386	5381	628	444	338	285	258	242	236	192	228	186	185
<b>Gender</b>													
Male	4294	2327	280	184	167	141	119	114	128	92	101	92	89
Female	5088	3053	348	259	171	144	138	128	108	99	127	94	96
Refused	4	1	*	1	*	*	1	*	*	1	*	*	*
<b>Age (years)</b>													
*	187	133	10	6	2	3	2	4	3	6	4	3	3
1-4	499	344	29	23	14	8	10	7	8	7	8	7	5
5-11	703	479	40	38	32	23	10	9	6	12	6	11	6
12-17	589	333	75	31	30	20	22	15	13	7	13	5	3
18-64	6059	3083	412	305	225	196	195	187	192	143	184	148	154
> 64	1349	1009	62	41	35	35	19	20	14	17	13	12	14
<b>Race</b>													
White	7591	4312	496	368	261	233	208	208	186	154	173	160	149
Black	945	550	66	41	37	26	29	18	31	23	33	15	22
Asian	157	109	12	3	7	5	3	2	5	3	3	2	1
Some Others	182	103	10	8	9	5	7	3	2	3	5	4	4
Hispanic	385	220	39	17	21	13	9	9	10	8	12	5	6
Refused	126	87	5	7	3	3	2	2	2	1	2	*	3
<b>Hispanic</b>													
No	8534	4868	573	396	295	267	238	226	213	181	202	173	168
Yes	702	414	48	38	38	16	18	14	21	10	23	11	13
DK	47	29	3	4	2	*	1	*	1	*	1	2	1
Refused	103	70	4	6	3	2	1	2	1	1	2	*	3
<b>Employment</b>													
*	1773	1149	143	91	74	50	39	29	26	28	27	22	14
Full Time	4096	2054	286	203	140	141	124	126	134	96	134	109	110
Part Time	802	421	51	42	36	25	32	27	17	23	28	12	16
Not Employed	2644	1709	145	105	87	67	61	56	58	43	38	43	44
Refused	71	48	3	3	1	2	2	4	1	2	1	*	1
<b>Education</b>													
*	1968	1264	153	98	81	56	49	38	30	31	30	27	18
< High School	834	457	34	28	23	16	15	23	38	15	20	26	12
High School Graduate	2612	1297	160	115	94	86	92	84	69	71	93	64	76
< College	1801	972	114	87	76	62	50	56	49	44	52	35	44
College Graduate	1247	774	88	70	42	38	32	24	32	23	20	22	21
Post Graduate	924	617	79	46	22	27	20	17	18	8	13	12	14
<b>Census Region</b>													
Northeast	2075	1143	150	108	66	73	61	63	54	52	56	40	38
Midwest	2102	1164	145	110	75	65	69	37	63	42	55	51	41
South	3243	1834	206	137	116	106	76	92	85	58	87	60	76
West	1966	1240	127	89	81	41	52	50	34	40	30	35	30
<b>Day of Week</b>													
Weekday	6316	3655	430	301	227	188	164	146	171	127	169	128	116
Weekend	3070	1726	198	143	111	97	94	96	65	65	59	58	69
<b>Season</b>													
Winter	2524	1478	180	113	91	81	65	68	53	39	60	48	41
Spring	2438	1404	154	120	82	73	73	61	61	50	58	40	61
Summer	2536	1477	165	116	88	71	64	64	68	61	52	57	45
Fall	1888	1022	129	95	77	60	56	49	54	42	58	41	38
<b>Asthma</b>													
No	8629	4942	580	419	308	264	237	223	216	175	213	172	173
Yes	694	396	42	24	29	20	20	17	20	16	13	13	12
DK	63	43	6	1	1	1	1	2	*	1	2	1	*
<b>Angina</b>													
No	9061	5169	610	430	331	273	252	235	233	187	223	184	181
Yes	250	63	13	11	5	11	5	5	2	5	4	*	4
DK	75	49	5	3	2	1	1	2	1	*	1	2	*
<b>Bronchitis/emphysema</b>													
No	8882	5133	593	423	311	267	246	224	219	182	215	177	174
Yes	433	197	30	20	24	17	11	16	17	10	11	7	11
DK	71	51	5	1	3	1	1	2	*	*	2	2	*





Table 15-142 Range of Time (minutes) Spent Smoking Based on the Number of Respondents (continued)													
	Number of Minutes												
	660-720	720-780	780-840	840-900	900-960	960-1020	1020-1080	1080-1140	1140-1200	1200-1260	1260-1320	1320-1380	1380-1440
<b>Overall</b>	149	135	162	105	83	53	27	21	12	12	3	6	15
<b>Gender</b>													
Male	84	76	87	66	48	37	18	14	9	6	3	3	10
Female	65	59	75	39	35	17	9	7	3	6	*	3	5
Refused	*	*	*	*	*	*	*	*	*	*	*	*	*
<b>Age (years)</b>													
*	2	1	1	1	*	2	*	*	*	*	*	*	1
1-4	3	5	6	3	2	3	2	2	1	*	1	*	1
5-11	7	2	5	2	*	1	5	2	2	3	*	*	2
12-17	7	3	5	3	1	1	*	*	2	2	*	*	*
18-64	119	114	129	91	72	44	18	17	9	5	2	5	10
> 64	11	10	16	5	8	2	2	*	*	2	*	1	1
<b>Race</b>													
White	135	118	139	90	74	49	21	16	11	11	2	3	14
Black	7	10	8	9	6	3	5	2	1	*	*	2	1
Asian	*	*	2	*	*	*	*	*	*	*	*	*	*
Some Others	3	2	6	2	2	*	*	1	*	1	1	1	*
Hispanic	3	3	6	2	1	*	*	1	*	*	*	*	*
Refused	1	2	1	2	*	1	1	1	*	*	*	*	*
<b>Hispanic</b>													
No	141	127	149	96	81	52	25	19	12	11	2	6	13
Yes	5	6	11	8	2	1	1	1	*	1	1	*	1
DK	1	1	*	*	*	*	*	*	*	*	*	*	1
Refused	2	1	2	1	*	*	1	1	*	*	*	*	*
<b>Employment</b>													
*	16	10	16	8	3	5	7	4	3	5	1	*	3
Full Time	83	82	82	72	50	34	10	11	5	2	*	2	6
Part Time	18	11	16	6	10	2	2	3	*	2	*	1	1
Not Employed	31	32	48	18	19	12	8	3	4	3	2	3	5
Refused	1	*	*	1	1	*	*	*	*	*	*	*	*
<b>Education</b>													
*	19	12	18	10	3	7	8	4	3	5	1	*	3
< High School	15	24	34	16	16	7	6	2	1	1	*	2	3
High School Graduate	60	64	62	45	33	17	6	5	5	3	1	2	8
< College	36	22	29	18	23	12	5	6	3	2	1	2	1
College Graduate	11	9	12	10	6	8	1	4	*	*	*	*	*
Post Graduate	8	4	7	6	2	2	1	*	*	1	*	*	*
<b>Census Region</b>													
Northeast	37	34	34	23	20	10	2	4	2	2	*	1	2
Midwest	36	28	36	29	15	13	11	8	1	2	1	1	4
South	52	63	60	37	37	21	11	6	7	5	*	4	7
West	24	10	32	16	11	9	3	3	2	3	2	*	2
<b>Day of Week</b>													
Weekday	95	84	103	63	55	38	17	12	8	8	2	1	8
Weekend	54	51	59	42	28	15	10	9	4	4	1	5	7
<b>Season</b>													
Winter	30	47	46	26	21	11	7	6	4	1	2	1	5
Spring	41	36	44	29	10	14	5	5	4	5	1	2	5
Summer	38	23	45	31	33	13	11	5	2	3	*	2	2
Fall	40	29	27	19	19	15	4	5	2	3	*	1	3
<b>Asthma</b>													
No	134	124	150	92	77	47	24	20	9	9	3	5	13
Yes	15	9	11	13	6	5	3	1	3	3	*	1	2
DK	*	2	1	*	*	1	*	*	*	*	*	*	*
<b>Angina</b>													
No	141	130	157	103	82	48	26	20	12	12	2	5	15
Yes	4	3	4	2	1	4	1	1	*	*	1	1	*
DK	4	2	1	*	*	1	*	*	*	*	*	*	*
<b>Bronchitis/emphysema</b>													
No	139	128	150	91	75	48	25	20	11	9	3	4	15
Yes	10	5	12	14	8	4	2	1	1	3	*	2	*
DK	*	2	*	*	*	1	*	*	*	*	*	*	*

Note: \* = Missing Data; DK = Don't know; N = Number of Respondents; Refused = Respondent Refused to Answer.  
Source: Tsang And Klepeis, 1996.



Table 15-143 Number of Minutes Spent Smoking (minutes/day)

Category	Population Group	N	Percentiles											
			1	2	5	10	25	50	75	90	95	98	99	100
Overall		9386	0	0	0	0	0	0	240	615	795	930	1035	1440
Gender	Male	4294	0	0	0	0	0	0	310	685	840	983	1095	1440
Gender	Female	5088	0	0	0	0	0	0	180	545	725	870	960	1440
Age (years)	1-4	499	0	0	0	0	0	0	75	455	735	975	1095	1440
Age (years)	5-11	703	0	0	0	0	0	0	82	370	625	975	1140	1440
Age (years)	12-17	589	0	0	0	0	0	0	130	377	542	810	864	1260
Age (years)	18-64	6059	0	0	0	0	0	0	345	675	830	950	1045	1440
Age (years)	> 64	1349	0	0	0	0	0	0	10	340	622	825	910	1440
Race	White	7591	0	0	0	0	0	0	250	630	805	940	1035	1440
Race	Black	945	0	0	0	0	0	0	225	540	715	910	1071	1440
Race	Asian	157	0	0	0	0	0	0	60	375	494	565	790	800
Race	Some Others	182	0	0	0	0	0	0	255	680	815	1140	1305	1328
Race	Hispanic	385	0	0	0	0	0	0	175	481	652	813	845	1095
Hispanic	No	8534	0	0	0	0	0	0	243	625	800	940	1035	1440
Hispanic	Yes	702	0	0	0	0	0	0	175	518	680	850	920	1440
Employment	Full Time	4096	0	0	0	0	0	0	360	687	835	945	1005	1440
Employment	Part Time	802	0	0	0	0	0	0	295	630	793	930	1054	1440
Employment	Not Employed	2644	0	0	0	0	0	0	144.5	555	768	915	1045	1440
Education	< High School	834	0	0	0	0	0	0	420	790	880	1004	1105	1440
Education	High School Graduate	2612	0	0	0	0	0	5	390	710	840	956	1060	1440
Education	< College	1801	0	0	0	0	0	0	288	630	805	945	1045	1435
Education	College Graduate	1247	0	0	0	0	0	0	135	480	660	860	970	1140
Education	Post Graduate	924	0	0	0	0	0	0	60	380	595	795	860	1205
Census Region	Northeast	2075	0	0	0	0	0	0	259	610	775	915	990	1440
Census Region	Midwest	2102	0	0	0	0	0	0	255	630	810	945	1054	1440
Census Region	South	3243	0	0	0	0	0	0	275	655	810	950	1060	1440
Census Region	West	1966	0	0	0	0	0	0	140	510	710	885	990	1440
Day of Week	Weekday	6316	0	0	0	0	0	0	225	595	780	925	1015	1440
Day of Week	Weekend	3070	0	0	0	0	0	0	260	651	810	950	1080	1440
Season	Winter	2524	0	0	0	0	0	0	210	600	790	930	1034	1440
Season	Spring	2438	0	0	0	0	0	0	240	626	785	920	1060	1440
Season	Summer	2536	0	0	0	0	0	0	235	600	810	940	1020	1440
Season	Fall	1888	0	0	0	0	0	0	285	630	791	945	1020	1440
Asthma	No	8629	0	0	0	0	0	0	240	610	790	928	1020	1440
Asthma	Yes	694	0	0	0	0	0	0	270	668	855	1020	1170	1440
Angina	No	9061	0	0	0	0	0	0	240	615	795	930	1034	1440
Angina	Yes	250	0	0	0	0	0	0	125	615	835	1007.5	1125	1380
Bronchitis/emphysema	No	8882	0	0	0	0	0	0	235	605	785	928	1020	1440
Bronchitis/emphysema	Yes	433	0	0	0	0	0	50	405	810	900	1040	1205	1380

Note: N = Doer Sample Size; Percentiles are the Percentage of Doers below or Equal to a Given Number of Minutes.  
Source: Tsang and Klepeis, 1996.



Table 15-144 Range of Time Spent Smoking Cigars or Pipe Tobacco by the Number of Respondents

	Total N	Number of Minutes per Day							
		*-*	0-3	3-6	6-9	9-12	12-15	15-18	18-61
<b>Overall</b>	62	5	10	8	6	1	2	9	21
<b>Gender</b>									
Male	58	5	8	7	6	1	2	9	20
Female	4	*	2	1	*	*	*	*	1
<b>Age (years)</b>									
5-11	1	*	*	1	*	*	*	*	*
12-17	1	1	*	*	*	*	*	*	*
18-64	46	3	10	4	6	1	1	5	16
> 64	14	1	*	3	*	*	1	4	5
<b>Race</b>									
White	53	3	8	7	4	1	1	9	20
Black	5	1	2	1	1	*	*	*	*
Some Others	1	1	*	*	*	*	*	*	*
Hispanic	3	*	*	*	1	*	1	*	1
<b>Hispanic</b>									
No	57	5	9	8	5	*	1	9	20
Yes	5	*	1	*	1	1	1	*	1
<b>Employment</b>									
*	2	1	*	1	*	*	*	*	*
Full Time	39	2	7	4	5	1	1	4	15
Part Time	3	*	3	*	*	*	*	*	*
Not Employed	17	1	*	3	1	*	1	5	6
Refused	1	1	*	*	*	*	*	*	*
<b>Education</b>									
*	2	1	*	1	*	*	*	*	*
< High School	2	*	*	*	*	*	1	*	1
High School Graduate	24	2	4	4	3	*	*	3	8
< College	18	2	4	*	*	1	*	4	7
College Graduate	10	*	2	2	2	*	*	1	3
Post Graduate	6	*	*	1	1	*	1	1	2
<b>Census Region</b>									
Northeast	20	3	1	4	*	1	*	1	10
Midwest	19	*	4	4	2	*	1	4	4
South	12	1	3	*	2	*	1	1	4
West	11	1	2	*	2	*	*	3	3
<b>Day of Week</b>									
Weekday	40	3	7	5	2	1	*	7	15
Weekend	22	2	3	3	4	*	2	2	6
<b>Season</b>									
Winter	16	*	3	5	1	*	1	3	3
Spring	19	3	4	1	1	*	*	2	8
Summer	19	1	1	1	4	1	1	2	8
Fall	8	1	2	1	*	*	*	2	2
<b>Asthma</b>									
No	59	5	8	8	6	1	2	8	21
Yes	3	*	2	*	*	*	*	1	*
<b>Angina</b>									
No	60	5	10	8	6	1	2	8	20
Yes	2	*	*	*	*	*	*	1	1
<b>Bronchitis/emphysema</b>									
No	60	4	10	8	6	1	2	8	21
Yes	2	1	*	*	*	*	*	1	*

Note: \* Signifies missing data; Refused = respondents refused to answer; N = doer sample size in specified range of number of minutes spent. A value of "61" for number of minutes signifies that more than 60 minutes were spent.  
Source: Tsang and Klepeis, 1996.



Table 15-145 Number of Minutes Spent Smoking Cigars or Pipe Tobacco (minutes/day)

Category	Population Group	N	Percentiles											
			1	2	5	10	25	50	75	90	95	98	99	100
Overall		57	2	3	3	10	20	60	61	61	61	61	61	61
Gender	Male	53	3	5	10	10	20	60	61	61	61	61	61	61
Gender	Female	4	2	2	2	2	2.5	9	38	61	61	61	61	61
Age (years)	5-11	1	15	15	15	15	15	15	15	15	15	15	15	15
Age (years)	12-17	0	0	0	0	0	0	0	0	0	0	0	0	0
Age (years)	18-64	43	2	2	3	10	15	45	61	61	61	61	61	61
Age (years)	> 64	13	15	15	15	20	45	60	61	61	61	61	61	61
Race	White	50	2	2.5	3	10	20	60	61	61	61	61	61	61
Race	Black	4	10	10	10	10	10	15	25	30	30	30	30	30
Race	Some Others	0	0	0	0	0	0	0	0	0	0	0	0	0
Race	Hispanic	3	30	30	30	30	30	45	61	61	61	61	61	61
Hispanic	No	52	2	3	3	10	20	60	61	61	61	61	61	61
Hispanic	Yes	5	10	10	10	10	30	40	45	61	61	61	61	61
Employment	Full Time	37	2	2	3	10	20	60	61	61	61	61	61	61
Employment	Part Time	3	3	3	3	3	3	10	10	10	10	10	10	10
Employment	Not Employed	16	15	15	15	20	37.5	60	61	61	61	61	61	61
Education	< High School	2	45	45	45	45	45	53	61	61	61	61	61	61
Education	High School Graduate	22	2	2	10	10	15	45	61	61	61	61	61	61
Education	< College	16	3	3	3	3	25	60	61	61	61	61	61	61
Education	College Graduate	10	5	5	5	7.5	20	30	61	61	61	61	61	61
Education	Post Graduate	6	20	20	20	20	30	52.5	61	61	61	61	61	61
Census Region	Northeast	17	10	10	10	20	20	61	61	61	61	61	61	61
Census Region	Midwest	19	2	2	2	3	15	30	60	61	61	61	61	61
Census Region	South	11	10	10	10	10	10	45	61	61	61	61	61	61
Census Region	West	10	10	10	10	10	30	60	61	61	61	61	61	61
Day of Week	Weekday	37	2	2	3	10	20	60	61	61	61	61	61	61
Day of Week	Weekend	20	3	3	6.5	10	20	37.5	61	61	61	61	61	61
Season	Winter	16	3	3	3	10	15	25	60	61	61	61	61	61
Season	Spring	16	2	2	2	5	15	60.5	61	61	61	61	61	61
Season	Summer	18	10	10	10	20	30	60	61	61	61	61	61	61
Season	Fall	7	3	3	3	3	10	60	61	61	61	61	61	61
Asthma	No	54	2	3	10	10	20	60	61	61	61	61	61	61
Asthma	Yes	3	3	3	3	3	3	5	60	60	60	60	60	60
Angina	No	55	2	3	3	10	20	60	61	61	61	61	61	61
Angina	Yes	2	60	60	60	60	60	60.5	61	61	61	61	61	61
Bronchitis/emphysema	No	56	2	3	3	10	20	60	61	61	61	61	61	61
Bronchitis/emphysema	Yes	1	60	60	60	60	60	60	60	60	60	60	60	60

Note: A value of "61" for number of minutes signifies that more than 60 minutes were spent; N = doer sample size. Percentiles are the percentage of doers below or equal to a given number of minutes.

Source: Tsang and Klepeis, 1996.



	Total N	Number of Cigarettes Smoked by Respondent on the Day Before the Survey									
		*	None	1-2	3-5	6-9	10-14	15-24	25-35	36+	DK
<b>Overall</b>	4663	530	3288	45	92	88	182	315	56	57	10
<b>Gender</b>											
Male	2163	278	1467	24	38	32	81	167	30	43	3
Female	2498	251	1820	21	54	56	101	148	26	14	7
Refused	2	1	1	*	*	*	*	*	*	*	*
<b>Age (years)</b>											
*	84	2	72	1	1	*	2	3	1	1	1
1-4	263	263	*	*	*	*	*	*	*	*	*
5-11	348	258	88	*	1	*	*	1	*	*	*
12-17	326	1	315	*	1	3	2	3	*	*	1
18-64	2972	5	2232	42	76	75	156	276	54	51	5
> 64	670	1	581	2	13	10	22	32	1	5	3
<b>Race</b>											
White	3774	413	2664	30	63	63	156	272	54	52	7
Black	463	53	319	7	18	22	17	22	1	1	3
Asian	77	5	71	*	*	*	*	1	*	*	*
Some Others	96	22	55	1	4	1	5	6	1	1	*
Hispanic	193	37	133	7	5	2	2	7	*	*	*
Refused	60	*	46	*	2	*	2	7	*	3	*
<b>Hispanic</b>											
No	4244	452	3010	33	79	79	173	297	56	55	10
Yes	347	75	225	11	10	7	7	12	*	*	*
DK	26	2	18	*	2	2	1	1	*	*	*
Refused	46	1	35	1	1	*	1	5	*	2	*
<b>Employment</b>											
*	926	526	388	*	2	3	2	3	*	*	2
Full Time	2017	1	1510	34	55	51	100	193	37	34	2
Part Time	379	*	307	5	7	6	23	22	4	3	2
Not Employed	1309	3	1058	6	28	28	57	92	14	20	3
Refused	32	*	25	*	*	*	*	5	1	*	1
<b>Education</b>											
*	1021	526	473	*	4	3	4	8	*	1	2
< High School	399	3	279	1	9	12	27	42	8	16	2
High School Graduate	1253	1	899	16	44	35	73	138	23	23	1
< College	895	*	696	11	19	20	44	75	18	9	3
College Graduate	650	*	547	11	10	13	26	32	5	5	1
Post Graduate	445	*	394	6	6	5	8	20	2	3	1
<b>Census Region</b>											
Northeast	1048	112	747	4	12	19	49	78	10	16	1
Midwest	1036	110	746	11	25	19	29	73	13	8	2
South	1601	193	1079	17	37	34	76	108	29	24	4
West	978	115	716	13	18	16	28	56	4	9	3
<b>Day of Week</b>											
Weekday	3156	341	2239	28	66	61	116	217	38	43	7
Weekend	1507	189	1049	17	26	27	66	98	18	14	3
<b>Season</b>											
Winter	1264	163	883	16	23	21	50	71	18	14	5
Spring	1181	148	819	13	22	14	45	94	14	10	2
Summer	1275	142	906	7	20	32	47	89	12	17	3
Fall	943	77	680	9	27	21	40	61	12	16	*
<b>Asthma</b>											
No	4287	480	3023	40	85	80	171	292	51	56	9
Yes	341	48	239	5	6	8	10	18	5	1	1
DK	35	2	26	*	1	*	1	5	*	*	*
<b>Angina</b>											
No	4500	526	3161	45	88	85	175	304	52	54	10
Yes	125	2	99	*	3	3	5	8	3	2	*
DK	38	2	28	*	1	*	2	3	1	1	*
<b>Bronchitis/emphysema</b>											
No	4424	519	3138	43	80	81	170	284	48	52	9
Yes	203	11	120	2	11	6	11	28	8	5	1
DK	36	*	30	*	1	1	1	3	*	*	*

Note: \* = Missing Data; DK = Don't Know; N= Number of Respondents; Refused = Respondent Refused to Answer  
Source: Tsang and Klepeis, 1996.



Table 15-147 Range of Number of Cigarettes Smoked by Other People Based on Number of Respondents

	Total N	Number of Cigarettes Smoked By Others									
		*	None	1-2	3-5	6-9	10-14	15-24	25-35	36+	DK
<b>Overall</b>	4723	898	3209	55	108	78	122	121	19	28	85
<b>Gender</b>											
Male	2131	468	1403	21	35	39	61	46	11	12	35
Female	2590	428	1806	34	73	39	61	75	8	16	50
Refused	2	2	*	*	*	*	*	*	*	*	*
<b>Age (years)</b>											
*	103	11	82	*	2	*	*	3	*	1	4
1-4	236	236	*	*	*	*	*	*	*	*	*
5-11	355	355	*	*	*	*	*	*	*	*	*
12-17	263	263	*	*	*	*	*	*	*	*	*
18-64	3087	32	2506	46	97	74	116	109	16	24	67
> 64	679	1	621	9	9	4	6	9	3	3	14
<b>Race</b>											
White	3817	675	2616	42	89	70	106	107	18	24	70
Black	482	119	309	7	8	6	9	9	1	2	12
Asian	80	21	57	1	*	*	1	*	*	*	*
Some Others	86	29	51	*	*	1	3	1	*	1	*
Hispanic	192	50	120	5	9	1	3	1	*	1	2
Refused	66	4	56	*	2	*	*	3	*	*	1
<b>Hispanic</b>											
No	4290	796	2928	49	91	73	114	118	19	25	77
Yes	355	95	223	5	15	3	7	1	*	1	5
DK	21	4	11	1	*	1	1	*	*	2	1
Refused	57	3	47	*	2	1	*	2	*	*	2
<b>Employment</b>											
*	847	845	2	*	*	*	*	*	*	*	*
Full Time	2079	*	1740	28	64	50	73	59	9	10	46
Part Time	423	21	336	6	15	4	14	11	1	3	12
Not Employed	1335	30	1098	21	28	24	35	48	9	15	27
Refused	39	2	33	*	1	*	*	3	*	*	*
<b>Education</b>											
*	947	897	44	*	1	*	*	4	*	*	1
< High School	435	*	336	6	18	9	17	16	4	10	19
High School Graduate	1359	*	1097	25	38	40	47	62	9	9	32
< College	906	1	748	10	29	22	36	22	5	9	24
College Graduate	597	*	536	9	15	5	17	11	*	*	4
Post Graduate	479	*	448	5	7	2	5	6	1	*	5
<b>Census Region</b>											
Northeast	1027	201	690	14	29	18	14	32	3	4	22
Midwest	1066	196	726	15	28	13	27	25	4	7	25
South	1642	320	1090	17	36	33	58	44	7	15	22
West	988	181	703	9	15	14	23	20	5	2	16
<b>Day of Week</b>											
Weekday	3160	596	2178	33	76	54	77	69	12	14	51
Weekend	1563	302	1031	22	32	24	45	52	7	14	34
<b>Season</b>											
Winter	1260	266	841	17	23	19	29	34	7	6	18
Spring	1257	270	821	14	35	22	27	32	4	10	22
Summer	1261	240	863	13	25	18	35	30	3	6	28
Fall	945	122	684	11	25	19	31	25	5	6	17
<b>Asthma</b>											
No	4342	802	2989	52	97	69	117	104	15	22	75
Yes	353	95	196	3	10	9	5	16	4	6	9
DK	28	1	24	*	1	*	*	1	*	*	1
<b>Angina</b>											
No	4561	894	3068	53	104	78	121	116	19	26	82
Yes	125	1	110	2	3	*	1	4	*	2	2
DK	37	3	31	*	1	*	*	1	*	*	1
<b>Bronchitis/emphysema</b>											
No	4458	875	3016	53	99	75	115	108	17	23	77
Yes	230	21	163	2	8	3	7	12	2	5	7
DK	35	2	30	*	1	*	*	1	*	*	1

Note: \* = Missing Data; DK = Don't know; N = Number of Respondents; Refused = Respondent Refused to Answer.  
 Source: Tsang And Klepeis, 1996.



Table 15-148 Range of the Number of Cigarettes Smoked While at Home Based on the Number of Respondents

	Total N	Number of Cigarettes Smoked by Respondent at Home									
		*	None	1-2	3-5	6-9	10-14	15-24	25-35	36+	DK
<b>Overall</b>	4723	516	3358	51	193	126	224	180	23	29	23
<b>Gender</b>											
Male	2131	277	1463	24	86	53	91	98	11	17	11
Female	2590	237	1895	27	107	73	133	82	12	12	12
Refused	2	2	*	*	*	*	*	*	*	*	*
<b>Age (years)</b>											
*	103	8	83	*	2	4	1	2	1	*	2
1-4	236	236	*	*	*	*	*	*	*	*	*
5-11	355	268	86	*	*	*	1	*	*	*	*
12-17	263	2	248	*	6	2	3	1	1	*	*
18-64	3087	1	2352	47	170	110	193	150	21	26	17
> 64	679	1	589	4	15	10	26	27	0	3	4
<b>Race</b>											
White	3817	391	2700	30	152	103	208	164	22	28	19
Black	482	61	345	10	27	20	9	6	1	*	3
Asian	80	13	65	*	2	*	*	*	*	*	*
Some Others	86	17	58	1	3	1	2	3	*	1	*
Hispanic	192	32	140	8	3	2	3	4	*	*	*
Refused	66	2	50	2	6	*	2	3	*	*	1
<b>Hispanic</b>											
No	4290	451	3045	41	182	121	210	167	23	29	21
Yes	355	64	252	8	4	5	10	11	*	*	1
DK	21	*	18	*	1	*	2	*	*	*	*
Refused	57	1	43	2	6	*	2	2	*	*	1
<b>Employment</b>											
*	847	514	322	*	5	1	3	1	1	*	*
Full Time	2079	1	1598	33	122	88	117	87	11	10	12
Part Time	423	*	346	4	17	10	27	12	3	3	1
Not Employed	1335	1	1060	14	47	27	76	78	7	16	9
Refused	39	*	32	*	2	*	1	2	1	*	1
<b>Education</b>											
*	947	514	406	1	9	3	6	4	2	*	2
< High School	435	*	309	5	20	17	32	26	7	12	7
High School Graduate	1359	*	989	21	78	64	98	84	7	11	7
< College	906	2	701	17	51	25	56	39	4	5	6
College Graduate	597	*	524	6	20	11	19	13	2	1	1
Post Graduate	479	*	429	1	15	6	13	14	1	*	*
<b>Census Region</b>											
Northeast	1027	121	721	11	39	22	50	46	8	5	4
Midwest	1066	102	764	12	52	32	53	33	5	7	6
South	1642	177	1159	16	62	51	81	63	8	14	11
West	988	116	714	12	40	21	40	38	2	3	2
<b>Day of Week</b>											
Weekday	3160	336	2277	32	129	87	134	118	14	18	15
Weekend	1563	180	1081	19	64	39	90	62	9	11	8
<b>Season</b>											
Winter	1260	153	873	18	53	39	59	42	10	6	7
Spring	1257	152	901	7	51	22	55	54	1	6	8
Summer	1261	139	896	10	44	33	64	53	7	10	5
Fall	945	72	688	16	45	32	46	31	5	7	3
<b>Asthma</b>											
No	4342	470	3100	45	176	112	208	165	20	25	21
Yes	353	46	234	5	15	14	16	15	3	4	1
DK	28	*	24	1	2	*	*	*	*	*	1
<b>Angina</b>											
No	4561	515	3225	49	188	123	217	173	23	26	22
Yes	125	*	104	1	2	3	5	7	*	3	*
DK	37	1	29	1	3	*	2	*	*	*	1
<b>Bronchitis/emphysema</b>											
No	4458	501	3179	46	179	121	210	159	21	20	22
Yes	230	15	149	4	12	5	14	20	2	9	*
DK	35	*	30	1	2	*	*	1	*	*	1

Note: \* = Missing Data; DK = Don't Know; N= Number of Respondents; Refused = Respondent Refused to Answer  
Source: Tsang and Klepeis, 1996.



Table 15-149. Differences in Time Use (hours/week) Grouped by Sex, Employment Status, and Marital Status for the Surveys Conducted in 1965 and 1975							
	Employed Men		Employed Women		Housewives		Total
<b>Urban Data</b>	Married	Single	Married	Single	Married	Single	
<b>1965</b>	(N=448)	(N=73)	(N=190)	(N=152)	(N=341)	(N=14)	(N=1218)
Sleep	53.1	50.6	53.8	52.6	53.9	58.8	53.3
Work for Pay	51.3	51.4	38.4	39.8	0.5	1.6	33.0
Family Care	9.0	7.7	28.8	20.6	50.0	45.7	25.4
Personal Care	20.9	22.2	20.3	21.7	22.6	23.0	21.5
Free Time	33.7	36.1	26.7	33.3	41.0	38.9	34.8
Organizations	2.6	3.6	1.4	3.7	3.4	3.4	2.8
Media	17.1	13.9	10.7	11.1	15.3	19.1	14.7
Social Life	7.2	10.4	7.9	9.6	12.6	10.2	9.4
Recreation	1.4	1.3	0.6	0.5	0.6	1.1	0.9
Other Leisure	5.4	6.9	6.1	8.4	9.1	5.1	7.0
Total Time	168.0	168.0	168.0	168.0	168.0	168.0	168.0
(Free)	(33.7)	(36.1)	(26.7)	(33.3)	(41.0)	(38.9)	(34.8)
<b>1975</b>	(N=245)	(N=87)	(N=117)	(N=108)	(N=141)	(N=28)	(N=726)
Sleep	53.4	54.1	55.1	54.3	56.8	58.6	54.7
Work for Pay	47.4	40.0	30.1	38.8	1.1	0.0	32.5
Family Care	9.7	9.0	24.9	16.6	44.3	42.8	20.5
Personal Care	21.4	20.0	26.2	21.9	21.4	19.2	21.8
Free Time	36.1	44.9	31.7	36.4	44.4	47.4	38.5
Organizations	3.7	4.8	1.1	4.4	4.8	3.0	3.8
Media	18.9	18.5	15.6	14.5	20.4	27.2	18.2
Social Life	6.4	8.9	6.6	8.9	10.1	9.1	7.8
Recreation	1.3	4.1	0.8	0.5	0.7	0.4	1.3
Other Leisure	5.8	8.6	6.5	8.1	8.4	7.7	7.4
Total Time	168.0	168.0	168.0	168.0	168.0	168.0	168.0
(Free)	(36.1)	(44.9)	(31.7)	(36.4)	(44.4)	(47.4)	(38.5)

<sup>a</sup> Data weighted to ensure equal days of the week.

Source: Robinson, 1977.





Table 15-150. Time Use (hours/week)<sup>a</sup> Differences by Age for the Surveys Conducted in 1965 and 1975

Activity	Mean Duration (hrs/wk)									
	Age Group (years)									
	18-25		25-35		36-45		46-55		56-65	
	1965 (N=200)	1975 (N=149)	1965 (N=321)	1975 (N=234)	1965 (N=306)	1975 (N=150)	1965 (N=252)	1975 (N=141)	1965 (N=156)	1975 (N=111)
Sleep	54.2	55.4	52.5	53.9	53.1	54.7	53.9	55.4	53.6	56.0
Work for Pay	32.6	27.0	29.2	33.4	33.1	34.4	33.4	31.0	35.9	20.4
Family Care	21.2	15.3	30.4	21.6	25.4	20.4	24.9	23.2	20.4	23.2
Personal Care	20.9	20.3	20.3	20.8	22.5	21.1	22.4	23.1	20.9	26.6
Free Time	39.1	50.0	35.6	38.4	33.8	37.3	33.4	35.2	37.1	41.8
Organizations	4.8	8.4	3.0	4.2	3.0	3.3	2.0	3.1	2.9	3.2
Media	13.8	18.5	14.6	17.2	14.5	18.3	15.3	18.8	17.4	22.6
Social Life	11.3	10.7	10.3	8.7	8.4	7.8	8.6	5.4	8.1	6.2
Recreation	0.9	2.6	1.2	1.3	0.8	1.0	0.6	1.3	1.1	1.3
Other Leisure	8.3	9.8	6.5	7.0	7.1	6.9	6.9	6.6	7.6	8.5
Total Time	168.0	168.0	168.0	168.0	168.0	168.0	168.0	168.0	168.0	168.0
Free Time	(39.1)	(50.0)	(35.6)	(38.4)	(33.8)	(37.3)	(33.4)	(35.2)	(37.1)	(41.8)

<sup>a</sup> Data weighted to ensure equal days of the week.

Source: Robinson, 1977.



Table 15-151. Time Use (hours/week)<sup>a</sup> Differences by Education for the Surveys Conducted in 1965 and 1975

Activity	Mean duration (hours/week)									
	Age Group (in years)									
	0-8		9-11		12		13-15		16+	
	1965 (N=171)	1975 (N=75)	1965 (N=220)	1975 (N=114)	1965 (N=452)	1975 (N=319)	1965 (N=195)	1975 (N=137)	1965 (N=191)	1975 (N=144)
Sleep	54.9	57.0	52.3	53.7	53.0	55.5	53.6	53.6	53.6	54.8
Work for Pay	31.6	30.0	33.1	32.0	30.9	26.9	34.4	27.5	34.5	38.0
Family Care	24.7	18.7	25.4	21.7	28.9	23.5	21.7	18.9	21.2	16.8
Personal Care	20.8	22.9	20.9	22.0	21.1	22.1	21.7	10.5	22.7	22.3
Free Time	35.9	39.4	36.1	38.6	34.1	40.0	36.5	47.5	35.9	36.1
Organizations	1.8	3.0	1.5	2.2	2.5	3.7	5.8	9.1	4.7	4.1
Media	19.3	18.0	16.5	20.7	14.2	19.0	13.3	19.7	12.5	16.2
Social Life	7.7	8.4	9.8	7.9	9.5	8.5	9.0	7.7	10.2	8.1
Recreation	0.9	1.3	1.4	0.7	0.7	1.3	1.1	2.0	0.9	1.3
Other Leisure	6.3	8.7	7.0	7.1	7.2	7.5	7.4	9.0	7.7	6.4
Total Time	168.0	168.0	168.0	168.0	168.0	168.0	168.0	168.0	168.0	168.0
Free Time	(36.0)	(39.4)	(36.2)	(38.6)	(34.1)	(40.0)	(36.6)	(47.5)	(36.0)	(36.1)

a Data weighted to ensure equal days of the week.  
Source: Robinson, 1977.



Table 15-152. Time Use (hours/week) <sup>a</sup> Differences by Race for the Surveys Conducted in 1965 and 1975				
Activity Category	Mean duration (hours/week)			
	White		Black	
	1965 (N = 1030)	1975 (N = 680)	1965 (N = 103)	1975 (N = 77)
Sleep	53.4	54.5	50.9	54.8
Work for Pay	31.9	30.0	36.6	30.0
Family Care	26.0	21.1	23.6	17.6
Personal Care	21.8	22.1	20.0	21.0
Free Time	34.9	40.3	36.9	44.6
Organizations	2.8	4.4	3.0	4.9
Media	14.8	18.7	15.7	19.6
Social Life	9.3	8.2	9.1	9.8
Recreation	1.1	1.5	0.6	0.4
Other Leisure	6.9	7.5	8.4	9.9
Total Time	168.0	168.0	168.0	168.0
Free Time	(34.9)	(40.3)	(36.8)	(44.6)

<sup>a</sup> Data weighted to ensure equal days of the week.

Source: Robinson, 1977.

Table 15-153. Mean Time Spent (hours/week) <sup>a</sup> in Ten Major Activity Categories Grouped by Regions						
Activity	West N=200	North Central N=304	Northeast N=185	South N=286	Total <sup>b</sup> N=975	
					Mean	S.D. <sup>c</sup>
<b>Activity Actegory</b>						
Market Work	23.44	29.02	27.34	24.21	26.15	23.83
House/yard work	14.64	14.17	14.29	15.44	14.66	12.09
Child care	2.50	2.82	2.32	2.66	2.62	5.14
Services/shop	5.22	5.64	4.92	4.72	5.15	5.40
Personal care	79.23	76.62	78.11	79.38	78.24	12.70
Education	2.94	1.43	0.95	1.45	1.65	6.34
Organizations	3.42	2.97	2.45	2.68	2.88	5.40
Social entertainment	8.26	8.42	8.98	8.22	8.43	8.17
Active leisure	5.94	5.28	4.77	5.86	5.49	7.81
Passive leisure	22.47	21.71	23.94	23.47	22.80	13.35
Total Time	168.00	168.00	168.00	168.00	168.00	0.09

<sup>a</sup> Weighted for day of week, panel loss (not defined in report), and correspondence to Census. Data may not add to totals shown due to rounding.

<sup>b</sup> N = surveyed population.

<sup>c</sup> S.D. = standard deviation.

Source: Hill, 1985.



Table 15-154. Total Mean Time Spent (minutes/day) in Ten Major Activity Categories Grouped by Type of Day

Activity Category	Time Duration (mins/day)		
	Weekday [N <sup>a</sup> = 831]	Saturday [N = 831]	Sunday [N = 831]
Market Work	288.0 (257.7) <sup>b</sup>	97.9 (211.9)	58.0 (164.8)
House/Yardwork	126.3 (119.3)	160.5 (157.2)	124.5 (133.3)
Child Care	26.6 (50.9)	19.4 (51.5)	24.8 (61.9)
Services/Shopping	48.7 (58.7)	64.4 (92.5)	21.6 (49.9)
Personal Care	639.2 (114.8)	706.8 (169.8)	734.3 (156.5)
Education	16.4 (64.4)	5.4 (38.1)	7.3 (48.0)
Organizations	21.1 (49.7)	18.4 (75.2)	58.5 (104.5)
Social Entertainment	54.9 (69.2)	1,114.1 (156.0)	110.0 (151.2)
Active Leisure	37.9 (71.11)	61.4 (126.5)	64.5 (120.6)
Passive Leisure	181.1 (121.9)	191.8 (161.6)	236.5 (167.1)
Total Time	1,440	1,440	1,440

a N = Number of respondents.  
b ( ) = Numbers in parentheses are standard deviations.  
Source: Hill, 1985.

Table 15-155. Mean Time Spent (minutes/day) in Ten Major Activity Categories During Four Waves of Interviews<sup>a</sup>

Activity Category	Fall (Nov. 1, 1975) <sup>b</sup> N=861	Winter (Feb. 28, 1976) <sup>b</sup>	Spring (June 1, 1976) <sup>b</sup> N=861	Summer (Sept. 21, 1976) <sup>b</sup> N=861	Range of Standard Deviations
	Wave 1	Wave 2	Wave 3	Wave 4	
Market work	222.94	226.53	210.44	230.92	272-287
House/yard work	133.16	135.58	143.10	119.95	129-156
Child care	25.50	22.44	25.51	21.07	49-58
Services/shop	48.98	44.09	44.61	47.75	76-79
Personal care	652.95	678.14	688.27	674.85	143-181
Education	22.79	12.57	2.87	10.76	32-93
Organizations	25.30	22.55	23.21	29.91	68-87
Social entertainment	63.87	67.11	83.90	72.24	102-127
Active leisure	42.71	47.46	46.19	42.30	96-105
Passive leisure	210.75	183.48	171.85	190.19	144-162
Total Time	1440.00	1440.00	1440.00	1440.00	--

<sup>a</sup> Weighted for day of week, panel loss (not defined in report), and correspondence to Census.  
<sup>b</sup> Dates by which 50% of the interviews for each wave were taken.  
Source: Hill, 1985.



Table 15-156. Mean Time Spent (hours/week) in Ten Major Activity Categories Grouped by Gender<sup>a</sup>

Activity Category	Time duration (hours/week)					
	Men n = 140		Women n = 561		Men and Women n = 971	
	Mean	SD	Mean	SD	Mean	SD
Market work	35.8	(23.6) <sup>b</sup>	17.9	(20.7)	26.2	(23.8)
House/yard	8.5	(9.0)	20.0	(11.9)	14.7	(12.1)
Child care	1.2	(2.5)	3.9	(6.4)	2.6	(5.2)
Services/shop	3.9	(4.5)	6.3	(5.9)	5.2	(5.4)
Personal care	77.3	(13.0)	79.0	(12.4)	78.2	(12.7)
Education	2.3	(7.7)	1.1	(4.8)	1.7	(6.4)
Organizations	2.5	(5.5)	3.2	(5.3)	2.9	(5.4)
Social entertainment	7.9	(8.3)	8.9	(8.0)	8.4	(8.2)
Active leisure	5.9	(8.2)	5.2	(7.4)	5.5	(7.8)
Passive leisure	22.8	(14.1)	22.7	(12.7)	22.8	(13.3)
Total time	168.1		168.1		168.1	

<sup>a</sup> Detailed components of activities (87) are presented in Table 1A-4.  
<sup>b</sup> ( ) = Numbers in parentheses are standard deviations.  
 Source: Hill, 1985.

Table 15-157. Percent Responses of Children's "Play" (activities) Locations in Maryvale, Arizona<sup>a</sup>

Location	Percent Responses			Ranking of Children's "Play" Locations <sup>c</sup>
	Preschool n = 211	Primary Grades (K-3) n = 45	Intermediate Grades (4-6) n = 66	
Residential Yards	143 <sup>b</sup>	124 <sup>b</sup>	132 <sup>b</sup>	Residential (Own and Others)
School Playgrounds	0	53	52	Parks and Recreation Areas
Parks and Recreation Areas	42	53	33	Street/Path/Alley
Commercial	2	24	27	Natural/Vacant Areas
Industrial	0	0	2	School
Institutional	1	2	0	Institutional
Streets	3	24	41	Commercial
Alleys	1	2	9	Parking Lots
Parking Lots	0	9	9	Child Built Places
Vacant Lots/Canals/Fields	1	7	8	Water
				Industrial

<sup>a</sup> Survey was conducted in Maryvale (West Central Phoenix), Arizona.  
<sup>b</sup> Percentages greater than 100, because many children played in more than one location.  
<sup>c</sup> Ranking of children's activity locations were obtained from other literature sources.  
 Source: Sell, 1989.



Table 15-158. Occupational Tenure of Employed Individuals <sup>a</sup> by Age and Sex			
Age Group (years)	Median Tenure (years)		
	All Workers	Men	Women
16-24	1.9	2.0	1.9
25-29	4.4	4.6	4.1
30-34	6.9	7.6	6.0
35-39	9.0	10.4	7.0
40-44	10.7	13.8	8.0
45-49	13.3	17.5	10.0
50-54	15.2	20.0	10.8
55-59	17.7	21.9	12.4
60-64	19.4	23.9	14.5
65-69	20.1	26.9	15.6
70 and older	21.9	30.5	18.8
Total	6.6	7.9	5.4

a Working population = 109.1 million persons  
Source: Carey, 1988.

Table 15-159. Occupational Tenure for Employed Individuals <sup>a</sup> Grouped by Sex and Race			
Race	Median Tenure (Years)		
	All Individuals	Men	Women
White	6.7	8.3	5.4
Black	5.8	5.8	5.8
Hispanic	4.5	5.1	3.7

a Working population = 109.1 million persons.  
Source: Carey, 1988.

Table 15-160. Occupational Tenure for Employed Individuals <sup>a</sup> Grouped by Sex and Employment Status			
Employment Status	Median Tenure (Years)		
	All Individuals	Men	Women
Full-Time	7.2	8.4	5.9
Part-Time	3.1	2.4	3.6

a Working population = 109.9 million persons.  
Source: Carey, 1988.



Table 15-161. Occupational Tenure of Employed Individuals <sup>a</sup> Grouped by Major Occupational Groups and Age							
Occupational Group	Median Tenure (years)						
	Age Group						
	Total <sup>b</sup>	16-24	25-34	35-44	45-54	55-64	65+
Executive, Administrative, and Managerial	8.4	2.4	5.6	10.1	15.1	17.9	26.3
Professional Specialty	9.6	2.0	5.7	12.0	18.2	25.6	36.2
Technicians and Related Support	6.9	2.2	5.7	10.9	17.7	20.8	22.2
Sales Occupations	5.1	1.7	4.7	7.7	10.5	15.5	21.6
Administrative Support, including Clerical	5.4	2.1	5.0	7.6	10.9	14.6	15.4
Service Occupations	4.1	1.7	4.4	6.9	9.0	10.6	10.4
Precision Production, Craft, and Repair	9.3	2.6	7.1	13.5	19.9	25.7	30.1
Operators, Fabricators, and Laborers	5.5	1.7	4.6	9.1	13.7	18.1	14.7
Farming, Forestry, and Fishing	10.4	2.9	7.9	13.5	20.7	30.5	39.8

a Working population = 109.1 million persons.  
 b Includes all workers 16 years and older  
 Source: Carey, 1988.

Table 15-162. Voluntary Occupational Mobility Rates for Workers <sup>a</sup> Age 16 Years and Older	
Age Group (years)	Occupational Mobility Rate <sup>b</sup> (Percent)
16-24	12.7
25-34	6.6
35-44	4.0
45-54	1.9
55-64	1.0
64 and older	0.3
Total, age 16 and older	5.3

a Working population = 109.1 million persons.  
 b Occupational mobility rate = percentage of persons employed in an occupation who had voluntarily entered it from another occupation.  
 Source: Carey, 1990.



Table 15-163. Values and Their Standard Errors for Average Total Residence Time, T, for Each Group in Survey<sup>a</sup>

Households	Average total residence time T (years)	S.D. S <sub>T</sub>	Average current residence T <sub>CR</sub> (years)	Households (percent)	
				1985	1987
All households	4.55 ± 0.60	8.68	10.56±0.10	100.0	100.0
Renters	2.35±0.14	4.02	4.62±0.08	36.5	36.0
Owners	11.36±3.87	13.72	13.96±0.12	63.5	64.0
Farms	17.31±13.81	18.69	18.75±0.38	2.1	1.9
Urban	4.19±0.53	8.17	10.07±0.10	74.9	74.5
Rural	7.80±1.17	11.28	12.06±0.23	25.1	25.5
Northeast region	7.37±0.88	11.48	12.64±0.12	21.2	20.9
Midwest region	5.11±0.68	9.37	11.15±0.10	25.0	24.5
South region	3.96±0.47	8.03	10.12±0.08	34.0	34.4
West region	3.49±0.57	6.84	8.44±0.11	19.8	20.2

<sup>a</sup>Values of the average current residence time, T<sub>CR</sub>, are given for comparison.  
Source: Israeli and Nelson, 1992.

Table 15-164. Total Residence Time, t (years), Corresponding to Selected Values of R(t)<sup>a</sup> by Housing Category

R(t) =	0.05	0.1	0.25	0.5	0.75
All households	23.1	12.9	3.7	1.4	0.5
Renters	8.0	5.2	2.6	1.2	0.5
Owners	41.4	32.0	17.1	5.2	1.4
Farms	58.4	48.3	26.7	10.0	2.4
Urban	21.7	10.9	3.4	1.4	0.5
Rural	32.3	21.7	9.1	3.3	1.2
Northeast region	34.4	22.3	7.5	2.8	1.0
Midwest region	25.7	15.0	4.3	1.6	0.6
South region	20.7	10.8	3.0	1.2	0.4
West region	17.1	8.9	2.9	1.2	0.4

<sup>a</sup> R(t) = fraction of households living in the same residence for t years or more.  
Source: Israeli and Nelson, 1992.





Table 15-165. Residence Time of Owner/Renter Occupied Units	
Year household moved into unit	Total occupied units (numbers in thousands)
1990-1994	24,534
1985-1989	27,054
1980-1984	10,613
1975-1979	9,369
1970-1974	6,233
1960-1969	7,933
1950-1959	4,754
1940-1949	1,772
1939 or earlier	<u>885</u>
	Total 93,147

Source: U.S. Bureau of the Census, 1993.

Table 15-166. Percent of Householders Living in Houses for Specified Ranges of Time	
Years lived in current home	Percent of total households
0-4	26.34
5-9	29.04
10-14	11.39
15-19	10.06
20-24	6.69
25-34	8.52
35-44	5.1
45-54	1.9
> 55	<u>0.95</u>
	Total <sup>a</sup> 99.99

a Total does not equal 100 due to rounding errors.  
Source: Adapted from U.S. Bureau of the Census, 1993.



Table 15-167. Descriptive Statistics for Residential Occupancy Period			
	Residential occupancy period (years)		
	Both genders	Males only	Females only
	N <sup>a</sup> = 500,000	N = 244,274	N = 255,726
<b>Statistic</b>	11.7	11.1	12.3
Mean	2	2	2
5th percentile	2	2	2
10th percentile	3	4	5
25th percentile	9	8	9
50th percentile	16	15	17
75th percentile	26	24	28
90th percentile	33	31	35
95th percentile	41	39	43
98th percentile	47	44	49
99th percentile	51	48	53
99.5th percentile	55	53	58
99.8th percentile	59	56	61
99.9th percentile	75	73	75
Second largest value	87	73	87
Largest value			

a = Number of simulated persons  
Source: Johnson and Capel, 1992.

Table 15-168. Descriptive Statistics for Both Genders by Current Age							
Current age, years	Residential occupancy period (years)						
	Mean	Percentile					
		25	50	75	90	95	99
3	6.5	3	5	8	13	17	22
6	8.0	4	7	10	15	18	22
9	8.9	5	8	12	16	18	22
12	9.3	5	9	13	16	18	23
15	9.1	5	8	12	16	18	23
18	8.2	4	7	11	16	19	23
21	6.0	2	4	8	13	17	23
24	5.2	2	4	6	11	15	25
27	6.0	3	5	8	12	16	27
30	7.3	3	6	9	14	19	32
33	8.7	4	7	11	17	23	39
36	10.4	5	8	13	21	28	47
39	12.0	5	9	15	24	31	48
42	13.5	6	11	18	27	35	49
45	15.3	7	13	20	31	38	52
48	16.6	8	14	22	32	39	52
51	17.4	9	15	24	33	39	50
54	18.3	9	16	25	34	40	50
57	19.1	10	17	26	35	41	51
60	19.7	11	18	27	35	40	51
63	20.2	11	19	27	36	41	51
66	20.7	12	20	28	36	41	50
69	21.2	12	20	29	37	42	50
72	21.6	13	20	29	37	43	53
75	21.5	13	20	29	38	43	53
78	21.4	12	19	29	38	44	53
81	21.2	11	20	29	39	45	55
84	20.3	11	19	28	37	44	56
87	20.6	10	18	29	39	46	57
90	18.9	8	15	27	40	47	56
All ages	11.7	4	9	16	26	33	47

Source: Johnson and Capel, 1992.



Table 15-169. Summary of Residence Time of Recent Home Buyers (1993)	
Number of years lived in previous house	Percent of Respondents
1 year or less	2
2-3	16
4-7	40
8-9	10
10 years or more	32

Source: NAR, 1993

Table 15-170. Tenure in Previous Home (Percentage Distribution)				
	Percent			
	1987	1989	1991	1993
One year or less	5	8	4	2
2-3 Years	25	15	21	16
4-7 Years	36	22	37	40
8-9 Years	10	11	9	10
10 or More Years	24	34	29	32
Total	100	100	100	100
Median	6	6	6	6

Source: NAR, 1993

Table 15-171. Number of Miles Moved (Percentage Distribution)					
	All Buyers	First-Time Buyer	Repeat Buyer	New Home Buyer	Existing Home Buyer
Miles	Percent				
Less than 5 miles	29	33	27	23	31
5 to 9 miles	20	25	16	18	20
10 to 19 miles	18	20	17	20	17
20 to 34 miles	9	11	8	12	9
35 to 50 miles	2	2	2	2	3
51 to 100 miles	5	2	6	6	4
Over 100 miles	17	6	24	19	16
Total	100	100	100	100	100
Median	9	8	11	11	8
Mean	200	110	270	230	190

Source: NAR, 1993



Table 15-172. Confidence in Activity Patterns Recommendations

Considerations	Rationale	Rating
<b>TIME SPENT INDOORS VS. OUTDOORS</b>		
<b>Study Elements</b>		
• Level of peer review	The studies received high level of peer review.	High
• Accessibility	The studies are widely available to the public.	High
• Reproducibility	The reproducibility of these studies is left to question. Evidence has shown that activities have tended to shift over the past decade since the studies were published, due to economic conditions and technological developments, etc. Thus, it is assumed there would be differences in reproducing these results. However, if data were reanalyzed in the same manner the results are expected to be the same.	Medium
• Focus on factor of interest	The study focused on general activity patterns. One study delineated between indoor and outdoor use of time but in many cases the locations were specified. Thus, any assumptions were made about the indoor or outdoor location where event took place.	High
• Data pertinent to US	The studies focused on the U.S. population and California.	High
• Primary data	One study analyzed data from a two primary studies. Data from the remaining study was collected to via questionnaires and interviews.	High
• Currency	The studies were published in 1985 (data was collected 1981-1982), 1987, 1991 (data was collected 1987-1990) and 1992.	Medium
• Adequacy of data collection period	In one study, households were sampled 4 times during 3 month intervals from February to December, 1981. Robinson's data was based on 1) the CARB Study where data was collected October 1987 to August 1988; and 2) the National Study where data was collected January through December 1985.	High
• Validity of approach	The approach used to collect data was direct and included questionnaires or interviews. Responses were based on diaries and 'mailback' surveys based on what the person planned to do the following day (the "tomorrow approach"). A 24 hour diary was used in another study.	High
• Study size	The study sizes ranged from 922 to 5,000 depending on the sub-group considered.	High
• Representativeness of the population	Timmer focused on activities of children. Robinson studies activities of both children and adults. The studies are representative of the US population and California State.	High
• Characterization of variability	Variability was characterized by age, gender, and day of the week; location of activities and various age categories for children. There was no mention of race and no socio-economic characterizations made.	Medium
• Lack of bias in study design (high rating is desirable)	Biases noted were sampled during time when children were in school (activities during vacation time are not represented); activities in the 1980's may differ than they are now;	Medium
• Measurement error	Measurement or recording error may occur since the diaries were based on recall (in most cases a 24 hour recall).	Medium
<b>Other Elements</b>		
• Number of studies	Two	High
• Agreement between researchers	Difficult to compare due to varying categories of activities and the unique age distributions found within each study.	Not Ranked
<b>Overall Rating</b>		<b>Medium</b>



Table 15-172. Confidence in Activity Patterns Recommendations (continued)		
Considerations	Rationale	Rating
<b>TIME SPENT IN A VEHICLE</b>		
<b>Study Elements</b>		
• Level of peer review	The study received high level of peer review.	High
• Accessibility	The study is widely available to the public.	High
• Reproducibility	The reproducibility of these studies is left to question. Evidence has shown that activities have tended to shift over the past decade since the studies were published, due to economic conditions, technological developments, etc. Thus, it is assumed there would be differences in reproducing these results.	Medium
• Focus on factor of interest	The study focused specifically focused on time spent in vehicle.	High
• Data pertinent to US	The studies focused on the U.S. population and California.	High
• Primary data	Robinson's study analyzed data from two primary studies, thus it secondary data.	High
• Currency	The studies were published in 1985 (data was collected 1981-1982), 1987, 1991 (data was collected 1987-1990) and 1992.	Medium
• Adequacy of data collection period	In one study, households were sampled 4 times during 3 month intervals from February to December, 1981. Robinson's data was based on 1) the Wiley et al. (1991) Study where data was collected October 1987 to August 1988; and 2) the National Study where data was collected January through December 1985.	High
• Validity of approach	The approach used to collect primary data was based on diary entries recorded the previous day with follow-up telephone interviews. Another study collected time diary data via mailback of questionnaires, telephone interviews. 'Mailback' surveys were based on the "tomorrow approach" where person knew they were to record in diaries in advance.	High
• Study size	The study sizes ranged from 922 to 5,000 depending on the sub-group considered.	High
• Representativeness of the population	The studies are representative of the US population and California State.	High
• Characterization of variability	Variability was characterized by age, gender, and day of the week. There was no mention of race and no socio-economic characterizations made.	Medium
• Lack of bias in study design (high rating is desirable)	Both studies lacked time distributions and were based on short-term data. Wiley et al. (1991) data was based recall, is limited to California's population, and only considered English speaking households.	Medium
• Measurement error	Measurement or recording error may occur when diaries were based on 24 hr recall.	Medium
<b>Other Elements</b>		
• Number of studies	One secondary study analyzing two primary studies	Medium
• Agreement between researchers	Similar activity patterns were found in both studies.	High
<b>Overall Rating</b>		<b>Medium</b>



Table 15-172. Confidence in Activity Patterns Recommendations (continued)

Considerations	Rationale	Rating
<b>TIME SPENT SHOWERING</b>		
<b><u>Study Elements</u></b>		
• Level of peer review	The study received high level of peer review.	High
• Accessibility	Currently, raw data are available to only EPA. It is not known when data will be publicly available.	Low
• Reproducibility	Results are reproducible.	High
• Focus on factor of interest	The study focused specifically focused on time spent showering.	High
• Data pertinent to US	The study focused on the U.S. general population.	High
• Primary data	The study was based on primary data.	High
• Currency	The study was published in 1996.	High
• Adequacy of data collection period	The data were collected between October 1992 and September 1994.	High
• Validity of approach	The study used a valid methodology and approach which, in addition to 24-hour diaries, collected information on temporal conditions and demographic data such as geographic location and socioeconomic status for various U.S. subgroups.	High
• Study size	Study consisted of 9,386 total participants..	High
• Representativeness of the population	The data were representative of the U.S. population.	High
• Characterization of variability	The study provides a distribution on showering duration.	High
• Lack of bias in study design (high rating is desirable)	The study includes distributions for showering duration. Study is based on short-term data.	High
• Measurement error	Measurement or recording error may occur because diaries are based on 24-hour recall.	Medium
<b><u>Other Elements</u></b>		
• Number of studies	One; the study was a national study.	Low
• Agreement between researchers	Recommendation is based on only one study but it is a widely accepted study and average value is comparable to a second key study.	High
<b>Overall Rating</b>		<b>High</b>



Table 15-172. Confidence in Activity Patterns Recommendations (continued)

Considerations	Rationale	Rating
<b>TIME SPENT BATHING</b>		
<b>Study Elements</b>		
• Level of peer review	The study received high level of peer review.	High
• Accessibility	Currently, raw data are available to only EPA. It is not known when data will be publicly available.	Low
• Reproducibility	Results can be reproduced or methodology can be followed and evaluated provided comparable economic and social conditions exists.	High
• Focus on factor of interest	The survey collected information on duration and frequency of selected activities and time spent in selected micro-environments.	High
• Data pertinent to US	The data represents the U.S. population.	High
• Primary data	The study was based on primary data.	High
• Currency	The study was published in 1996.	High
• Adequacy of data collection period	The data were collected between October 1992 and September 1994.	High
• Validity of approach	The study used a valid methodology and approach which, in addition to 24-hour diaries, collected information on temporal conditions and demographic data such as geographic location and socioeconomic status for various U.S. subgroups. Responses were weighted according to this demographic data.	High
• Study size	The study consisted of 9,386 total participants.	High
• Representativeness of the population	The studies were based on the U.S. population.	High
• Characterization of variability	The study provided data that varied across geographic region, race, gender, employment status, educational level, day of the week, seasonal conditions, and medical conditions of respondent..	High
• Lack of bias in study design (high rating is desirable)	The study includes distributions for bathing duration. Study is based on short-term data.	Medium
• Measurement error	Measurement or recording error may occur because diaries were based on 24-hour recall.	Medium
<b>Other Elements</b>		
• Number of studies	One; the study was based on one, primary, national study.	Low
• Agreement between researchers	Recommendation was based on only one study.	Not Ranked
<b>Overall Rating</b>		<b>High</b>



Table 15-172. Confidence in Activity Patterns Recommendations (continued)

Considerations	Rationale	Rating
<b>SHOWER AND BATHING FREQUENCY</b>		
<b><u>Study Elements</u></b>		
• Level of peer review	The study received high level of peer review.	High
• Accessibility	Currently, raw data is available to only EPA. It is not known when data will be publicly available.	Low
• Reproducibility	Results can be reproduced or methodology can be followed and evaluated provided comparable economic and social conditions exists.	High
• Focus on factor of interest	The survey collected information on duration and frequency of selected activities and time spent in selected micro-environments.	High
• Data pertinent to US	The data represents the U.S. population	High
• Primary data	The study was based on primary data.	High
• Currency	The study was published in 1996.	High
• Adequacy of data collection period	The data were collected between October 1992 and September 1994.	High
• Validity of approach	The study used a valid methodology and approach which, in addition to 24-hour diaries, collected information on temporal conditions and demographic data such as geographic location and socioeconomic status for various U.S. subgroups. Responses were weighted according to this demographic data.	High
• Study size	The study consisted of 9,386 total participants	High
• Representativeness of the population	Studies were based on the U.S. population.	High
• Characterization of variability	The study provided data that varied across geographic region, race, gender, employment status, educational level, day of the week, seasonal conditions, and medical conditions of respondent..	High
• Lack of bias in study design (high rating is desirable)	Study is based on short term data..	Medium
• Measurement error	Measurement or recording error may occur because diaries were based on 24-hour recall.	Medium
<b><u>Other Elements</u></b>		
• Number of studies	One; the study was based on one, primary, national study.	Low
• Agreement between researchers	Recommendation was based on only one study.	Not Ranked
<b>Overall Rating</b>		<b>High</b>





Table 15-172. Confidence in Activity Patterns Recommendations (continued)

Considerations	Rationale	Rating
<b>TIME SPENT SWIMMING</b>		
<b>Study Elements</b>		
• Level of peer review	Study received high level of peer review.	High
• Accessibility	Currently, raw data is available to only EPA. It is not known when data will be publicly available.	Low
• Reproducibility	Results can be reproduced or methodology can be followed and evaluated provided comparable economic and social conditions exists.	High
• Focus on factor of interest	The survey collected information on duration and frequency of selected activities and time spent in selected micro-environments.	High
• Data pertinent to US	The data represents the U.S. population	High
• Primary data	The study was based on primary data.	High
• Currency	The study was published in 1996.	High
• Adequacy of data collection period	The data were collected between October 1992 and September 1994.	High
• Validity of approach	The study used a valid methodology and approach which, in addition to 24-hour diaries, collected information on temporal conditions and demographic data such as geographic location and socioeconomic status for various U.S. subgroups. Responses were weighted according to this demographic data.	High
• Study size	The study consisted of 9,386 total participants	High
• Representativeness of the population	Studies were based on the U.S. population.	High
• Characterization of variability	The study provided data that varied across geographic region, race, gender, employment status, educational level, day of the week, seasonal conditions, and medical conditions of respondent..	High
• Lack of bias in study design (high rating is desirable)	The study includes distributions for swimming duration. Study is based on short term data.	Medium
• Measurement error	Measurement or recording error may occur because diaries were based on 24-hour recall.	Medium
<b>Other Elements</b>		
• Number of studies	One; the study was based on one, primary, national study.	Low
• Agreement between researchers	Recommendation was based on only one study.	Not Ranked
<b>Overall Rating</b>		<b>High</b>



Table 15-172. Confidence in Activity Patterns Recommendations (continued)

Considerations	Rationale	Rating
<b>RESIDENTIAL TIME SPENT INDOORS AND OUTDOORS</b>		
<b><u>Study Elements</u></b>		
• Level of peer review	The study received high level of peer review.	High
• Accessibility	Currently, raw data is available to only EPA. It is not known when data will be publicly available.	Low
• Reproducibility	Results can be reproduced or methodology can be followed and evaluated provided comparable economic and social conditions exists.	High
• Focus on factor of interest	The survey collected information on duration and frequency of selected activities and time spent in selected micro-environments.	High
• Data pertinent to US	The data represents the U.S. population	High
• Primary data	The study was based on primary data.	High
• Currency	The study was published in 1996.	High
• Adequacy of data collection period	Data were collected between October 1992 and September 1994.	High
• Validity of approach	The study used a valid methodology and approach which, in addition to 24-hour diaries, collected information on temporal conditions and demographic data such as geographic location and socioeconomic status for various U.S. subgroups. Responses were weighted according to this demographic data.	High
• Study size	The study consisted of 9,386 total participants	High
• Representativeness of the population	The studies were based on the U.S. population.	High
• Characterization of variability	The study provided data that varied across geographic region, race, gender, employment status, educational level, day of the week, seasonal conditions, and medical conditions of respondent..	High
• Lack of bias in study design (high rating is desirable)	The study includes distributions for time spent indoors and outdoors at ones residence. Study is based on short term data.	Medium
• Measurement error	Measurement or recording error may occur because diaries were based on 24-hour recall.	Medium
<b><u>Other Elements</u></b>		
• Number of studies	One; the study was based on one, primary, national study.	Low
• Agreement between researchers	Recommendation was based on only one study.	Not Ranked
<b>Overall Rating</b>		<b>High</b>



Table 15-173. Confidence in Occupational Mobility Recommendations

Considerations	Rationale	Rating
<b>Study Elements</b>		
• Level of peer review	The studies received high level of peer review	High
• Accessibility	The studies are widely available to the public.	High
• Reproducibility	If the data were re-collected in the same fashion, it is questionable whether the results would be the same based on changes in the economy that have occurred since study was conducted (more than 10 years ago). If the same data were analyzed according to the design of the study then it is expected the results would be the same.	Medium
• Focus on factor of interest	Occupational tenure was the focus of both key studies.	High
• Data pertinent to US	The data represents the U.S. population.	High
• Primary data	The two studies are secondary data sources since they are based on supplemental data to the January 1987 Current Population Study (a U.S. Census publication).	Medium
• Currency	The studies were published in 1988 (data was collection in 1987) and 1990 (data collected from 1986-1987).	Medium
• Adequacy of data collection period	The studies are based on census data, which is collected over a period of years. One study analyzed data for January 1987. The remaining study based data between a January 1986 and January 1987 time frame.	High
• Validity of approach	The studies used a valid methodologies and approaches.	High
• Study size	The study size for one is 109 Million; the remaining study's sample size was 100.1 Million.	High
• Representativeness of the population	The data are representative of the U.S. population.	High
• Characterization of variability	The studies provided averaged data according to gender, race, and education; age averages and percentiles were provided.	High
• Lack of bias in study design (high rating is desirable)	Much of the original study data is not available. Only median values are reported.	Medium
• Measurement error	There is no apparent error in measurement	High
<b>Other Elements</b>		
• Number of studies	Two	Medium
• Agreement between researchers	Difficult to compare between the number of years worked on a job and entry verses exit rate of various occupations. One set of data was recorded in number of years. The other set of data was recorded as a percent motility rate and grouped by age.	Not Ranked
<b>Overall Rating</b>		<b>High</b>



Study	Value	Method
Israeli and Nelson, 1992	4.6 yr (average) 1/6 a person's lifetime (70 yr) = 11.7 (modeled)	Average of current and total residence times
US Bureau of the Census, 1993	9 yr (50th percentile) 33 yr (90th percentile)	Current residence time
Johnson and Capel, 1992	26 yr (90th percentile) 33 yr (95th percentile) 47 yr (99th percentile) 12 yr (mean)	Residential occupancy period

Considerations	Rationale	Rating
<b>Study Elements</b>		
• Level of peer review	The studies received high levels of peer review and appear in publications.	High
• Accessibility	The studies are widely available to the public.	High
• Reproducibility	Results can be reproduced or methodology can be followed and evaluated.	High
• Focus on factor of interest	The Census data provided length of time at current. Two of the studies used modeling to estimate total time.	Medium
• Data pertinent to US	The data is based on the U.S. population	High
• Primary data	Two studies based results on modeled data and one based results on interviews.	Medium
• Currency	The reports were published in 1992 (based on data collected in 1985-1987) and 1993 (based on data collected from 1939 and 1994 (projected) .	Medium
• Adequacy of data collection period	The collection period was based on data collected over several years.	High
• Validity of approach	There are some concerns regarding the validity of approach. Data does not account for each member of the household, values are more realistic estimates for the individual's total residence time, than the average time a household has been living at its current residence. The moving process was modeled. In another study data was assumed to have an even distribution within the different ranges which may bias the 50th and 90th percentiles.	Medium
• Study size	The study size ranged from 15,000 to 500, 000.	High
• Representativeness of the population	Studies were based on the U.S. population.	High
• Characterization of variability	Variability across several geographic regions was noted. Type of ownership was also addressed. One study provided data grouped by race.	Medium
• Lack of bias in study design (high rating is desirable)	Mentioned above in validity of approach section.	Not Ranked
• Measurement error	There is no apparent error in measurement.	High
<b>Other Elements</b>		
• Number of studies	Three	High
• Agreement between researchers	The studies produced very similar results.	High
<b>Overall Rating</b>		<b>Medium</b>



Table 15-176. Summary of Recommended Values for Activity Factors

Type	Value	Study	
Indoor Activities	<u>Children</u> (ages 3-11)		
	19 hr/day (weekdays)	Timmer et al., 1985 -Key study	
	17 hr/day (weekends)	Timmer et al., 1985 -Key study	
	<u>Adults</u> (ages 12 and older)		
	21 hr/day	Robinson and Thomas, 1991 - Key study	
Outdoor Activities	<u>Children</u>		
	5 hr/day (weekdays)	Timmer et al., 1985 -Key study	
	7 hr/day (weekends)	Timmer et al., 1985 -Key study	
	<u>Adults</u>		
	1.5 hr/day	Robinson and Thomas, 1991 - Key study	
Time Spent Inside Vehicle	<u>Adults</u>	Robinson and Thomas, 1991 - Key study	
	1.3 hr/day	Tsang and Klepeis, 1996 - Key study	
Taking Baths	20 minutes/event	Tsang and Klepeis, 1996 - Key study	
Taking Showers	10 min/day shower duration	Tsang and Klepeis, 1996 - Key study	
	1 shower event/day	Tsang and Klepeis, 1996 - Key study	
Occupational Tenure	6.6 yrs (16 years and older)	Carey, 1988 - Relevant study	
Population Mobility	Average: 9 yr	US Bureau of the Census, 1993 - Key study	
	95th percentile: 30 yr		
Swimming	1 event/month	Tsang and Klepeis, 1996 - Key study	
	60 minutes/event		
Residential		Tsang and Klepeis, 1996 - Key study	
	Indoors		16.4 hr/day
	Outdoors		2 hr/day



**APPENDIX 15A**

**ACTIVITY PATTERNS CODES AND OCCUPATIONAL TENURE DATA**



Table 15A-1. Activity Codes and Descriptors Used for Adult Time Diaries

WORK AND OTHER INCOME-PRODUCING ACTIVITIES

Paid Work

- 01 - Normal work: activities at the main job including work brought home, travel that is part of the job, and overtime; "working," "at work"
  - Work at home; work activities for pay done in the home when home is the main workplace (include travel as above)
- 02 - Job search; looking for work, including visits to employment agencies, phone calls to prospective employers, answering want ads
  - Unemployment benefits; applying for or collecting unemployment compensation
  - Welfare, food stamps; applying for or collecting welfare, food stamps
- 05 - Second job; paid work activities that are not part of the main job (use this code only when R\* clearly indicates a second job or "other" job); paid work for those not having main job; garage sales, rental property
- 06 - Lunch at the workplace; lunch eaten at work, cafeteria, lunchroom when "where" = work (lunch at a restaurant, code 44; lunch at home, code 43)
  - Eating, smoking, drinking coffee as a secondary activity while working (at workplace)
- 07 - Before and/or after work at the workplace; activities at the workplace before starting or after stopping work; include "conversations," other work. Do not code secondary activities with this primary activity
  - Other work-related
- 08 - Coffee breaks and other breaks at the workplace; unscheduled breaks and other nonwork during work hours at the workplace; "took a break"; "had coffee" (as a primary activity). Do not code secondary activities with this primary activity
- 09 - Travel; to and from the workplace when R's travel to and from work were both interrupted by stops; waiting for related travel
  - Travel to and from the workplace, including time spent awaiting transportation

HOUSEHOLD ACTIVITIES

Indoor

- 10 - Meal preparation: cooking, fixing lunches
  - Serving food, setting table, putting groceries away. unloading car after grocery shopping
- 11 - Doing dishes, rinsing dishes, loading dishwasher
  - Meal cleanup, clearing table, unloading dishwasher

(continued on the following page)



Table 15A-1. Activity Codes and Descriptors Used for Adult Time Diaries (continued)

HOUSEHOLD ACTIVITIES (continued)

Indoor (continued)

- 12 - Miscellaneous, "worked around house." NA if indoor or outdoor - Routine indoor cleaning and chores, picking up, dusting, making beds, washing windows, vacuuming, "cleaning," "fall/spring cleaning," "housework"
- 14 - Laundry and clothes care - wash
  - Laundry and clothes care - iron, fold, mending, putting away clothes ("Sewing" code 84)
- 16 - Repairs indoors; fixing, repairing appliances
  - Repairs indoors; fixing, repairing furniture
  - Repairs indoors; fixing, repairing furnace, plumbing, painting a room
- 17 - Care of houseplants
- 19 - Other indoor, NA whether cleaning or repair; "did things in house"

Outdoor

- 13 - Routine outdoor cleaning and chores; yard work, raking leaves, mowing grass, garbage removal, snow shoveling, putting on storm windows, cleaning garage, cutting wood
- 16 - Repair, maintenance, exterior; fixing repairs outdoors, painting the house, fixing the roof, repairing the driveway (patching)
  - Home improvements: additions to and remodeling done to the house, garage; new roof
  - Improvement to grounds around house; repaved driveway
- 17 - Gardening; flower or vegetable gardening; spading, weeding, composting, picking, worked in garden"
- 19 - Other outdoor; "worked outside," "puttering in garage"

MISCELLANEOUS HOUSEHOLD CHORES

- 16 - Car care; necessary repairs and routine care to cars; tune up
  - Car maintenance; changed oil, changed tires, washed cars; "worked on car" except when clearly as a hobby - (code 83)
- 17 - Pet care; care of household pets including activities with pets; playing with the dog; walking the dog; (caring for pets of relatives, friends, code 42)

(continued on the following page)





Table 15A-1. Activity Codes and Descriptors Used for Adult Time Diaries (continued)

MISCELLANEOUS HOUSEHOLD CHORES (continued)

- 19 - Household paperwork; paying bills, balancing the checkbook, making lists, getting the mail, working on the budget
- Other household chores; (no travel), picking up things at home, e.g., "picked up deposit slips" (relate travel to purpose)

CHILD CARE

Child Care for Children of Household

- 20 - Baby care; care to children aged 4 and under
- 21 - Child care; care to children aged 5\*-17
- Child care; mixed ages or NA ages of children
- 22 - Helping/teaching children learn, fix, make things; helping son bake cookies; helping daughter fix bike
- Help with homework or supervising homework
- 23 - Giving children orders or instructions; asking them to help; telling the\*i\*n to behave
- Disciplining child; yelling at kids, spanking children; correcting children's behavior
- Reading to child
- Conversations with household children only; listening to children
- 24 - Indoor playing; other indoor activities with children (including games ("playing") unless obviously outdoor games)
- 25 - Outdoor playing; outdoor activities with children including sports, walks, biking with, other outdoor games
- Coaching/leading outdoor, nonorganizational activities
- 26 - Medical care at home or outside home; activities associated with children's health; "took son to doctor," "gave daughter medicine"

Other Child Care

- 27 - Babysitting (unpaid) or child care outside R's home or for children not residing in HH
- Coordinating or facilitating child's social or instructional nonschool activities; (travel related, code 29)
- Other child care, including phone conversations relating to child care other than medical
- 29 - Travel related to child's social and instructional nonschool activities
- Other travel related to child care activities; waiting for related travel

(continued on the following page)



Table 15A-1. Activity Codes and Descriptors Used for Adult Time Diaries (continued)

OBTAINING GOODS AND SERVICES

Goods (include phone calls to obtain goods)

- 30 - Groceries; supermarket, shopping for food
- All other shopping for goods; including for clothing, small appliances; at drugstores, hardware stores, department stores, "downtown" or "uptown," "shopping," "shopping center," buying gas, "window shopping"
- 31 - Durable household goods; shopping for large appliances, cars, furniture
- House, apartment: activities connected to buying, selling, renting, looking for house, apartment, including phone calls; showing house, including traveling around looking at real estate property (for own use)

Services (include phone conversations to obtain services)

- 32 - Personal care; beauty, barber shop; hairdressers
- 33 - Medical care for self; visits to doctor, dentist, optometrist, including making appointments
- 34 - Financial services; activities related to taking care of financial business; going to the bank, paying utility bills (not by mail), going to accountant, tax office, loan agency, insurance office
- Other government services: post office, driver's license, sporting licenses, marriage licenses, police station
- 35 - Auto services; repair and other auto services including waiting for such services
- Clothes repair and cleaning; cleaners, laundromat, tailor
- Appliance repair: including furnace, water heater, electric or battery operated appliances; including watching repair person
- Household repair services: including furniture; other repair services NA type; including watching repair person
- 37 - Other professional services; lawyer, counseling (therapy)
- Picking up food at a takeout place - no travel
- Other services, "going to the dump"
- 38 - Errands; "running errands," NA whether for goods or services; borrowing goods
- 39 - Related travel; travel related to obtaining goods and services and/or household activities except 31; waiting for related travel

(continued on the following page)



Table 15A-1. Activity Codes and Descriptors Used for Adult Time Diaries (continued)

PERSONAL NEEDS AND CARE

Care to Self

- 40 - Washing, showering, bathing
- Dressing; getting ready, packing and unpacking clothes, personal hygiene, going to the bathroom
  
- 41 - Medical care at home to self
  
- 43 - Meals at home; including coffee, drinking, smoking, food from a restaurant eaten at home, "breakfast," "lunch"
  
- 44 - Meals away from home; eaten at a friend's home (including coffee, drinking, smoking)
- Meals away from home, except at workplace (06) or at friend's home (44); eating at restaurants, out for coffee
  
- 45 - Night sleep; longest sleep for day; (may occur during day for night shift workers) including "in bed," but not asleep
  
- 46 - Naps and resting; rest periods, "dozing," "laying down" (relaxing code 98)
  
- 48 - Sex, making out
- Personal, private; "none of your business"
- Affection between household members; giving and getting hugs, kisses, sitting on laps

Help and Care to Others

- 41 - Medical care to adults in household (HH)
  
- 42 - Nonmedical care to adults in HH; routine nonmedical care to adults in household; "got my wife up," "ran a bath for my husband"
- Help and care to relatives not living in HH; helping care for, providing for needs of relatives; (except travel) helping move, bringing food, assisting in emergencies, doing housework for relatives; visiting when sick
- Help and care to neighbors, friends
- Help and care to others, NA relationship to respondent

Other Personal and Helping

- 48 - Other personal; watching personal care activities
  
- 49 - Travel (helping); travel related to code 42, including travel that is the helping activity; waiting for related travel
- Other personal travel; travel related to other personal care activities; waiting for related travel; travel, NA purpose of trip - e.g., "went to Memphis" (no further explanation given)

(continued on the following page)



Table 15A-1. Activity Codes and Descriptors Used for Adult Time Diaries (continued)

EDUCATION AND PROFESSIONAL TRAINING

- 50 - Student (full-time); attending classes, school if full-time student; includes daycare, nursery school for children not in school
- 51 - Other classes, courses, lectures, academic or professional; R not a full-time student or NA whether a student; being tutored
- 54 - Homework, studying, research, reading, related to classes or profession, except for current job (code 07); "went to the library"
- 56 - Other education
- 59 - Other school-related travel; travel related to education coded above; waiting for related travel; travel to school not originating from home

ORGANIZATIONAL ACTIVITIES

Volunteer, Helping Organizations: hospital volunteer group, United Fund, Red Cross, Big Brother/Sister

- 63 - Attending meetings of volunteer, helping organizations
- Officer work; work as an officer of volunteer, helping organizations; R must indicate he/she is an officer to be coded here
- Fund raising activities as a member of volunteer helping organization, collecting money, planning a collection drive
- Direct help to individuals or groups as a member of volunteer helping organizations; visiting, bringing food, driving
- Other activities as a member of volunteer helping organizations, including social events and meals

Religious Practice

- 65 - Attending services of a church or synagogue, including participating in the service; ushering, singing in choir, leading youth group, going to church, funerals
- Individual practice; religious practice carried out as an individual or in a small group; praying, meditating, Bible study group (not a church), visiting graves

Religious Groups

- 64 - Meetings: religious helping groups; attending meetings of helping - oriented church groups -ladies aid circle, missionary society, Knights of Columbus
- Other activities; religious helping groups; other activities as a member of groups listed above, including social activities and meals

(continued on the following page)



Table 15A-1. Activity Codes and Descriptors Used for Adult Time Diaries (continued)

ORGANIZATIONAL ACTIVITIES (continued)

Religious Groups (continued)

- Meetings: other church groups; attending meetings of church group, not primarily helping-oriented, or NA if helping-oriented
- Other activities, other church groups; other activities as a member of church groups that are not helping-oriented or NA if helping, including social activities and meals; choir practice; Bible class

Professional/Union Organizations: State Education Association; AFL-CIO; Teamsters

- 60
- Meetings; professional/union; attending meetings of professional or union groups
  - Other activities, professional/union; other activities as a member of professional or union group including social activities and meals

Child/Youth/Family Organizations: PTA, PTO; Boy/Girl Scouts; Little Leagues; YMCA/YWCA; school volunteer

- 67
- Meetings, family organizations; attending meetings of child/youth/family\*-oriented organizations
  - Other activities, family organizations; other activities as a member of child/youth/family-oriented organizations including social activities and meals

Fraternal Organizations: Moose, VFW, Kiwanis, Lions, Civitan, Chamber of Commerce, Shriners, American Legion

- 66
- Meetings, fraternal organizations; attending meetings of fraternal organizations
  - Other activities, fraternal organizations; other activities as a member of fraternal organizations including social activities and helping activities and meals

Political Party and Civic Participation: Citizens' groups, Young Democrats, Young Republicans, radical political groups, civic duties

- 62
- Meetings, political/citizen organizations; attending meetings of a political party or citizen group, including city council
  - Other activities, political/citizen organizations; other participation in political party and citizens' groups, including social activities, voting, jury duty, helping with elections, and meals

Special Interest/Identity Organizations (including groups based on sex, race, national origin); NOW; NAACP; Polish-American Society; neighborhood, block organizations; CR groups; senior citizens; Weight Watchers

- 61
- Meetings; identify organizations; attending meetings of special interest, identity organizations
  - Other activities, identity organizations; other activities as a member of a special interest, identity organization, including social activities and meals

(continued on the following page)



Table 15A-1. Activity Codes and Descriptors Used for Adult Time Diaries (continued)

ORGANIZATIONAL ACTIVITIES (continued)

Other Miscellaneous Organizations, do not fit above

- 68 - Other organizations; any activities as a member of an organization not fitting into above categories; (meetings and other activities included here)

Travel Related to Organizational Activities

- 69 - Travel related to organizational activities as a member of a volunteer (helping) organization (code 63); including travel that is the helping activity, waiting for related travel
- Travel (other organization-related); travel related to all other organization activities; waiting for related travel

ENTERTAINMENT/SOCIAL ACTIVITIES

Attending Spectacles, Events

- 70 - Sports; attending sports events - football, basketball, hockey, etc.
- 71 - Miscellaneous spectacles, events: circus, fairs, rock concerts, accidents
- 72 - Movies; "went to the show"
- 73 - Theater, opera, concert, ballet
- 74 - Museums, art galleries, exhibitions, zoos

Socializing

- 75 - Visiting with others; socializing with people other than R's own HH members either at R's home or another home (visiting on the phone, code 96); talking/chatting in the context of receiving a visit or paying a visit
- 76 - Party; reception, weddings
- 77 - At bar; cocktail lounge, nightclub; socializing or hoping to socialize at bar, lounge
- Dancing
- 78 - Other events; other events or socializing, do not fit above
- 79 - Related travel; waiting for related travel

(continued on the following page)



Table 15A-1. Activity Codes and Descriptors Used for Adult Time Diaries (continued)

SPORTS AND ACTIVE LEISURE

Active Sports

- 80 - Football, basketball, baseball, volleyball, hockey, soccer, field hockey
- Tennis, squash, racquetball, paddleball
- Golf, miniature golf
- Swimming, waterskiing
- Skiing, ice skating, sledding, roller skating
- Bowling; pool, ping-pong, pinball
- Frisbee, catch
- Exercises, yoga (gymnastics - code 86)
- Judo, boxing, wrestling

Out of Doors

- 81 - Hunting
- Fishing
- Boating, sailing, canoeing
- Camping, at the beach
- Snowmobiling, dune-buggies
- Gliding, ballooning, flying
- Excursions, pleasure drives (no destination), rides with the family
- Picnicking

Walking, Biking

- 82 - Walking for pleasure
- Hiking
- Jogging, running
- Bicycling
- Motorcycling
- Horseback riding

Hobbies

- 83 - Photography
- Working on cars - not necessarily related to their running; customizing, painting
- Working on or repairing leisure time equipment (repairing the boat, "sorting out fishing tackle")
- Collections, scrapbooks
- Carpentry and woodworking (as a hobby)

(continued on the following page)



Table 15A-1. Activity Codes and Descriptors Used for Adult Time Diaries (continued)

SPORTS AND ACTIVE LEISURE (continued)

Domestic Crafts

- 84 - Preserving foodstuffs (canning, pickling)
- Knitting, needlework, weaving, crocheting (including classes), crewel, embroidery, quilting, quilling, macrame
- Sewing
- Care of animals/livestock when R is not a farmer (pets, code 17; "farmer", code 01, work)

Art and Literature

- 85 - Sculpture, painting, potting, drawing
- Literature, poetry, writing (not letters), writing a diary

Music/Theater/Dance

- 86 - Playing a musical instrument (include practicing), whistling
- Singing
- Acting (rehearsal for play)
- Nonsocial dancing (ballet, modern dance, body movement)
- Gymnastics (lessons - code 88)

Games

- 87 - Playing card games (bridge, poker)
- Playing board games (Monopoly, Yahtzee, etc.), bingo, dominoes
- Playing social games (scavenger hunts), "played games" - NA kind
- Puzzles

Classes/Lessons for Active Leisure Activity

- 88 - Lessons in sports activities: swimming, golf, tennis, skating, roller skating
- Lessons in gymnastics, dance, judo, body movement
- Lessons in music, singing, instruments
- Other lessons, not listed above

Travel

- 89 - Related travel; travel related to sports and active leisure; waiting for related travel: vacation travel

(continued on the following page)





---

*Appendix 15A*

---

Table 15A-1. Activity Codes and Descriptors Used for Adult Time Diaries (continued)

PASSIVE LEISURE

- 90 - Radio
- 91 - TV
- 92 - Records, tapes, "listening to music," listening to others playing a musical instrument
- 93 - Reading books (current job related, code 07; professionally or class related, code 54)
- 94 - Reading magazines, reviews, pamphlets
  - Reading NA what; or other
- 95 - Reading newspapers
- 96 - Phone conversations - not coded elsewhere, including all visiting by phone
  - Other talking/conversations; face-to-face conversations, not coded elsewhere (if children in HH only, code 23); visiting other than 75
  - Conversations with HH members only - adults only or children and adults
  - Arguing or fighting with people other than HH members only, household and nonhousehold members, or NA
  - Arguing or fighting with HH members only
- 97 - Letters (reading or writing); reading mail
- 98 - Relaxing
  - Thinking, planning; reflecting
  - "doing nothing," "sat"; just sat;
  - Other passive leisure, smoking dope, pestering, teasing, joking around, messing around; laughing
- 99 - Related travel: waiting for related travel

MISSING DATA CODES

- Activities of others reported - R's activity not specified
- NA activities; a time gap of greater than 10 minutes.

EXAMPLES OF ACTIVITIES IN "OTHER" CATEGORIES

Other Work Related

- 07 - Foster parent activities

(continued on the following page)



Table 15A-1. Activity Codes and Descriptors Used for Adult Time Diaries (continued)

EXAMPLES OF ACTIVITIES IN "OTHER" CATEGORIES (continued)

Other Household

- 19 - Typing
- Wrapping presents
- Checked refrigerator for shopping list
- Unpacked gifts from shower
- Packing/unpacking car
- "Settled in" after trip
- Hooked up boat to car
- Showed wife car (R was fixing)
- Packing to move
- Moved boxes
- Looking/searching for things at home (inside or out)

Other Child Care

- 27 - Waited for son to get hair cut
- Picked up nephew at sister's house
- "Played with kids" (R's children from previous marriage not living with R)
- Called babysitter

Other Services

- 37 - Left clothing at Goodwill
- Unloaded furniture (just purchased)
- Returned books (at library)
- Brought clothes in from car (after laundromat)
- Delivered some stuff to a friend
- Waited for father to pick up meat
- Waited for stores to open
- Put away things from swap meet
- Sat in car waiting for rain to stop before shopping
- Waiting for others while they are shopping
- Showing mom what I bought

Other Personal

- 48 - Waiting to hear from daughter
- Stopped at home, NA what for
- Getting hysterical
- Breaking up a fight (not child care related)
- Waited for wife to get up

(continued on the following page)



Table 15A-1. Activity Codes and Descriptors Used for Adult Time Diaries (continued)

EXAMPLES OF ACTIVITIES IN "OTHER" CATEGORIES (continued)

Other Personal (continued)

- Waiting for dinner at brother's house
- Waiting for plane (meeting someone at airport)
- Laughing
- Crying
- Moaning - head hurt
- Watching personal care activities ("watched dad shave")

Other Education

- 56 - Watched a film  
- In discussion group

Other Organization

- 68 - Attending "Club House coffee klatch"  
- Waited for church activities to begin  
- "Meeting" NA kind  
- Cleanup after banquet  
- Checked into swap meet - selling and looking

Other Social, Entertainment

- 78 - Waiting for movies, other events  
- Opening presents (at a party)  
- Looking at gifts  
- Decorating for party  
- Tour of a home (friends or otherwise)  
- Waiting for date  
- Preparing for a shower (baby shower)  
- Unloaded uniforms (for parade)

Other Active Leisure

- 88 - Fed birds, bird watching  
- Astrology  
- Swinging  
- At park  
- Showing slides  
- Showing sketches

(continued on the following page)



Table 15A-1. Activity Codes and Descriptors Used for Adult Time Diaries (continued)

EXAMPLES OF ACTIVITIES IN "OTHER" CATEGORIES (continued)

Other Active Leisure (continued)

- Recording music
- Hung around airport (NA reason)
- Picked up fishing gear
- Inspecting motorcycle
- Arranging flowers
- Work on model airplane
- Picked asparagus
- Picked up softball equipment
- Registered to play golf
- Toured a village or lodge (coded 81)

Other Passive Leisure

- 98
- Lying in sun
  - Listening to birds
  - Looking at slides
  - Stopped at excavating place
  - Looking at pictures
  - Walked around outside
  - Waiting for a call
  - Watched plane leave
  - Girl watching/boy watching
  - Watching boats
  - Wasted time
  - In and out of house
  - Home movies

\* R = Respondent

HH = Household.

Source: Juster et al., 1983.



Appendix 15A

Table 15A-2. Differences in Average Time Spent in Different Activities Between California and National Studies (minutes per day for age 18-64 years)							
00-49	NON-FREE TIME	California 1987-88 (1359)	National 1985 (1980)	50-59	Free Time	California 1987-88 (1359)	National 1985 (1980)
00-09	PAID WORK			50-99	EDUCATION AND TRAINING		
00	(not used)			50	Students' Classes	9	5
01	Main Job	224	211	51	Other Classes	1	3
02	Unemployment	1	1	52	(not used)	-	-
03	Travel during work	8	NR	53	(not used)	-	-
04	(not used)	-	-	54	Homework	8	7
05	Second job	3	3	55	Library	*	1
06	Eating	6	8	56	Other Education	1	1
07	Before/after work	1	2	57	(not used)	-	-
08	Breaks	2	2	58	(not used)	-	-
09	Travel to/from work	28	25	59	Travel, Education	3	2
10-19	HOUSEHOLD WORK			60-69	ORGANIZATIONAL ACTIVITIES		
10	Food Preparation	29	36	60	Professional/Union	0	1
11	Meal Cleanup	10	11	61	Special Interest	*	1
12	Cleaning House	21	24	62	Political/Civic	0	*
13	Outdoor Cleaning	9	7	63	Volunteer/Helping	1	1
14	Clothes Care	7	11	64	Religious Groups	1	2
15	Car Repair/Maintenance (by R)	5	5	65	Religious Practice	5	7
16	Other Repairs (by R)	8	6	66	Fraternal	0	*
17	Plant Care	3	5	67	Child/Youth/Family	1	*
18	Animal Care	3	5	68	Other Organizations	2	1
19	Other Household	7	8	69	Travel Organizations	2	4
20-29	CHILD CARE			70-79	ENTERTAINMENT/ SOCIAL ACTIVITIES		
20	Baby Care	3	8	70	Sports Events	2	2
21	Child Care	7	5	71	Entertainment Events	5	1
22	Helping/Teaching	2	1	72	Movies	2	3
23	Talking/Reading	1	1	73	Theatre	1	1
24	Indoor Playing	2	3	74	Museums	1	*
25	Outdoor Playing	2	1	75	Visiting	26	25
26	Medical care - Care	*	1	76	Parties	6	7
27	Other Child Care	2	1	77	Bars/Lounges	4	6
28	(At Dry Cleaners)	*	NR	78	Other Social	*	1
29	Travel, Child care	4	4	79	Travel, Events/Social	13	16



Table 15A-2. Differences in Average Time Spent in Different Activities Between California and National Studies (minutes per day for age 18-64 years) (continued)							
00-49	NON-FREE TIME	California 1987-88 (1359)	National 1985 (1980)	50-59	Free Time	California 1987-88 (1359)	National 1985 (1980)
30-39	<b>OBTAINING GOODS AND SERVICES</b>			80-89	<b>RECREATION</b>		
30	Everyday Shopping	8	5	80	Active Sports	15	13
31	Durable/House Shop	19	20	81	Outdoor	3	7
32	Personal Services	1	1	82	Walking/Hiking	5	4
33	Medical Appointments	2	2	83	Hobbies	1	1
34	Gov't/Financial Service	3	2	84	Domestic Crafts	3	6
35	Car Repair services	2	1	85	Art	*	1
36	Other Repair services	*	1	86	Music/Drama/Dance	3	2
37	Other Services	2	2	87	Games	5	7
38	Errands	*	1	88	Computer Use/Other	3	3
39	Travel, Goods and Services	24	20	89	Travel, Recreation	5	6
40-49	<b>PERSONAL NEEDS AND CARE</b>			90-99	<b>COMMUNICATION</b>		
40	Washing, Etc.	21	25	90	Radio	1	3
41	Medical Care	3	1	91	TV	130	126
42	Help and Care	3	4	92	Records/Tapes	3	1
43	Meals At Home	44	50	93	Read Books	4	7
44	Meals Out	27	20	94	Reading Magazines/Other	16	10
45	Night Sleep	480	469	95	Reading Newspaper	11	9
46	Naps/Day Sleep	16	16	96	Conversations	15	25
47	Dressing, Etc.	24	32	97	Writing	8	9
48	NA Activity	2	12	98	Think, Relax	9	6
49	Travel, Personal Care/NA	22	13	99	Travel, Communication	5	*
NR =	Not Recorded in National Survey				Total Travel	108	90
* =	Less than 0.5 Min. per day				(Codes 09, 29, 39, 49, 59, 69, 79, 89, 99)		

Source: Robinson and Thomas, 1991.



Appendix 15A

Table 15A-3. Time Spent in Various Microenvironments

Code Description	N = 639 California	Mean duration				Total <sup>a</sup> N = 1359 National
		Men N = 914 National	N = 720 California	Women N = 1059 National	N = 1980 California	
<b>AT HOME</b>						
Kitchen	46	56	98	135	72	104
Living Room	181	136	98	180	189	158
Dining Room	18	10	22	18	19	15
Bathroom	27	27	38	43	33	38
Bedroom	481	478	534	531	508	521
Study	8	10	6	7	7	8
Garage	14	5	6	1	19	2
Basement	<0.5	4	<0.5	6	<0.5	5
Utility Room	1	0	3	5	2	4
Pool, Spa	1	NR	1	NR <sup>b</sup>	1	NR <sup>b</sup>
Yard	33		21		27	37
Room to Room	9	160 <sup>c</sup>	34	116	21	40
Other NR Room	3		4		3	22
<u>Total at home</u>	822	888	963	1022	892	954
<b>AWAY FROM HOME</b>						
Office	78	261	94	155	86	193
Plant	73	--	12	--	42	--
Grocery Store	12	18	14	33	13	30
Shopping Mall	30	--	40	--	35	--
School	25	13	29	11	27	15
Other Public Places	18	--	10	--	14	12
Hospital	9	NR	24	NR	17	3
Restaurant	35	22	25	18	30	23
Bar-Night Club	15	--	5	--	10	--
Church	7	8	5	11	6	10
Indoor Gym	4	NR	4	NR	4	NR
Other's Home	60	42	61	45	61	43
Auto Repair	18	NR	4	NR	11	NR
Playground	16	27	8	16	12	NR
Hotel-Motel	7	NR	8	NR	8	NR
Dry Cleaners	<0.5	NR	1	NR	1	NR
Beauty Parlor	<0.5	NR	4	NR	2	NR
Other Locations	3	NR	1	NR	2	NR
Other Indoor	17	41	7	24	12	24
Other Outdoor	60	NR	13	NR	37	6
<u>Total away from home</u>	487	445	371	324	430	383



Table 15A-3. Time Spent in Various Microenvironments (continued)

Code Description	N = 639 California	Men		Mean duration Women		Total <sup>a</sup>
		N = 914 National	N = 720 California	N = 1059 National	N = 1980 California	
<b>TRAVEL</b>						
Car	76	--	77	--	76	--
Van/Truck	30	86	11	77	20	88
Walking	10	--	8	--	9	2
Bus Stop	<0.5	--	1	--	1	--
Bus	6	--	2	--	4	3
Rapid Train	1	--	--	--	1	1
Other Travel	2	--	1	--	1	<0.5
Airplane	1	15	<0.5	10	1	1
Bicycle	1	--	<0.5	--	1	NR
Motorcycle	2	--	<0.5	--	1	NR
Other or Missing	1	--	<0.5	--	1	NR
			a			
<u>Total travel</u>	130	101	102	87	116	94
Not ascertained	1	8	4	7	2	9
Total Time Outdoors	--	--	--	--	88	70

<sup>a</sup> Totals do not necessarily reflect exact averages presented for each gender. Totals were revised, but revisions for each gender were not provided.

<sup>b</sup> NR = Not Reported

<sup>c</sup> Is total mean duration for those categories; breakdowns per category were not reported.

Source: Robinson and Thomas, 1991.

Note: Percent at home	<u>National</u>		<u>California</u>	
	men	= 62	men	= 57
	women	= 71	women	= 67
	total	= 67	total	= 62
Percent away from home	<u>National</u>		<u>California</u>	
	men	= 31	men	= 34
	women	= 23	women	= 26
	total	= 27	total	= 30
Percent in travel	<u>National</u>		<u>California</u>	
	men	= 7	men	= 9
	women	= 6	women	= 7
	total	= 7	total	= 8





Appendix 15A

Table 15A-4. Major Time Use Activity Categories<sup>a</sup>

Activity code	Activity
01-09	Market work
10-19	House/yard work
20-29	Child care
30-39	Services/shopping
40-49	Personal care
50-59	Education
60-69	Organizations
70-79	Social entertainment
80-89	Active leisure
90-99	Passive leisure

<sup>a</sup> Appendix Table 14A-3 presents a detailed explanation of the coding and activities.  
Source: Hill, 1985.



Table 15A-5. Mean Time Spent (minutes/day) for 87 Activities Grouped by Day of the Week

Activity	Weekday N=831		Saturday N=831		Sunday N=831	
	Mean	Std. Dev.	Mean	Std. Dev.	Mean	Std. Dev.
01-Normal Work	240.54	219.10	82.43	184.41	46.74	139.71
02-Unemployment Acts	0.98	9.43	0.00	0.00	0.00	0.00
05-Second Job	3.76	25.04	2.84	32.64	2.65	27.30
06-Lunch At Work	10.00	15.81	1.82	7.88	1.43	8.29
07-Before/After Work	3.51	10.05	1.45	9.79	1.66	13.76
08-Coffee Breaks	5.05	11.53	1.59	7.32	0.93	8.52
09-Travel: To/From Work	24.03	30.37	7.74	22.00	4.60	17.55
10-Meal Preparation	42.18	46.59	40.37	59.82	42.38	57.42
11-Meal Cleanup	12.48	19.25	12.07	22.96	13.97	25.85
12-Indoor Cleaning	26.37	43.84	38.88	80.39	21.73	48.70
13-Outdoor Cleaning	7.48	25.45	15.71	58.00	9.01	39.39
14-Laundry	13.35	30.39	11.48	31.04	7.79	25.43
16-Repairs/Maintenance	9.61	35.43	17.36	72.50	13.56	62.12
17-Garden/Pet Care	8.52	25.15	14.75	49.17	8.47	37.54
19-Other Household	6.26	20.62	9.82	37.58	7.60	32.17
20-Baby Care	6.29	22.91	5.89	30.72	6.26	33.78
21-Child Care	6.26	16.34	5.38	21.58	7.09	23.15
22-Helping/Teaching	1.36	8.28	0.23	3.64	0.76	6.52
23-Reading/Talking	2.47	8.65	1.71	10.84	1.53	9.97
24-Indoor Playing	1.75	8.72	0.90	7.82	2.45	15.11
25-Outdoor Playing	0.73	6.33	1.23	13.03	0.91	10.30
26-Medical Care-Child	0.64	7.42	0.16	2.79	0.44	7.20
27-Babysitting/Other	2.93	14.56	2.16	19.11	3.28	24.89
29-Travel: Child Care	4.18	10.97	1.71	8.72	2.08	10.56
30-Everyday Shopping	19.73	30.28	33.52	61.38	10.13	30.18
31-Durable/House Shop	0.58	4.83	1.46	14.04	1.65	17.92
32-Personal Care Services	1.93	10.04	3.42	18.94	0.02	0.69
33-Medical Appointments	3.43	14.49	0.60	6.63	0.00	0.00
34-Gov't/Financial Services	1.90	6.07	0.66	4.34	0.03	0.43
35-Repair Services	1.33	7.14	1.25	10.24	0.52	5.61
37-Other Services	1.13	7.17	1.55	9.57	0.72	4.34
38-Errands	0.74	8.03	0.35	5.27	0.04	1.04
39-Travel: Goods/Services	17.93	23.58	21.61	36.35	8.45	21.64
40-Washing/Dressing	44.03	29.82	44.25	41.20	47.54	40.15
41-Medical Care R/HH Adults	0.77	6.19	1.29	15.90	1.45	29.18
42-Help & Care	8.43	28.17	12.19	52.58	14.32	55.13
43-Meals At Home	53.45	35.57	57.86	49.25	61.84	49.27
44-Meals Out	19.55	31.20	31.13	56.03	25.95	47.60
45-Night Sleep	468.49	79.42	498.40	115.55	528.86	115.84
46-Naps/Resting	22.07	43.92	30.67	74.98	27.56	66.01
48-N.A. Activities	7.52	22.32	11.72	41.61	8.18	35.79
49-Travel: Personal	14.87	27.76	19.33	50.42	18.58	46.36
50-Students' Classes	6.33	33.79	0.96	18.17	0.96	20.07
51-Other Classes	2.65	17.92	0.40	11.52	0.27	5.63



Appendix 15A

Table 15A-5. Mean Time Spent (minutes/day) for 87 Activities Grouped by Day of the Week (continued)

Activity	Weekday N=831		Saturday N=831		Sunday N=831	
	Mean	Std. Dev.	Mean	Std. Dev.	Mean	Std. Dev.
54-Homework	4.56	24.35	3.48	27.98	5.40	38.68
56-Other Education	0.53	5.91	0.15	2.75	0.45	9.85
59-Travel: Education	2.29	10.36	0.35	4.26	0.21	3.14
60-Professional/Union Orgs.	0.51	7.27	0.13	3.64	0.44	8.34
61-Identity Organizations	1.53	11.19	1.24	35.63	0.48	7.58
62-Political/Citizen Orgs	0.14	1.25	0.07	1.91	0.19	5.55
63-Volunteer/Helping Orgs	1.08	10.08	0.02	0.45	0.41	7.09
64-Religious Groups	2.96	17.33	3.05	27.73	8.59	33.31
65-Religious Practice	4.98	19.92	7.13	30.12	34.05	62.06
66-Fraternal Organizations	0.85	9.28	1.73	27.71	0.31	6.67
67-Child/Family Organizations	1.70	11.69	1.04	17.83	0.26	7.63
68-Other Organizations	3.91	22.85	1.31	20.28	1.71	17.52
69-Traves: Organizations	3.41	9.83	2.66	12.22	12.07	37.64
70-Sport Events	2.22	13.45	6.29	42.05	3.44	27.78
71-Miscellaneous Events	0.32	4.89	1.94	19.90	1.96	19.75
72-Movies	1.65	11.03	4.74	27.04	3.35	22.65
73-Theater	0.69	7.13	2.66	27.79	0.77	10.37
74-Museums	0.19	3.32	0.90	13.62	0.72	11.17
75-Visiting w/Others	33.14	51.69	56.78	95.61	69.65	114.58
76-Parties	2.81	16.49	12.63	56.11	7.16	39.02
77-Bars/Lounges	3.62	18.07	7.23	35.09	3.91	26.95
78-Other Events	1.39	11.55	1.33	15.52	1.00	10.80
79-Travel: Events/Social	8.90	16.19	19.55	43.38	18.02	34.45
80-Active Sports	5.30	19.60	9.23	43.69	11.39	48.66
81-Outdoors	5.11	33.00	11.58	55.07	15.52	62.68
82-Walking/Biking	2.08	9.70	5.87	36.38	5.92	32.28
83-Hobbies	1.78	11.73	3.20	32.43	4.10	31.55
84-Domestic Crafts	11.18	37.03	8.67	40.49	6.41	34.82
85-Art/Literature	0.99	10.84	0.86	13.59	1.13	15.07
86-Music/Drama/Dance	0.45	4.91	0.83	8.83	0.63	8.32
87-Games	5.06	22.91	10.14	45.11	7.89	40.45
88-Classes/Other	2.65	15.83	2.56	29.92	3.37	23.60
89-Travel: Active Leisure	3.31	14.77	8.50	48.72	8.19	38.11
90-Radio	2.89	12.19	3.53	23.42	2.88	18.50
91-TV	113.01	103.89	118.99	131.24	149.67	141.43
92-Records/Tapes	2.58	20.26	2.40	16.09	2.03	16.08
93-Reading Books	4.41	18.09	2.76	17.85	5.23	30.13
94-Reading Magazines/N.A.	13.72	31.73	16.33	46.24	17.18	51.01
95-Reading Newspapers	12.03	22.65	12.19	34.96	26.01	44.47
96-Conversations	18.68	28.59	15.45	35.27	14.57	34.60
97-Letters	2.83	12.23	1.61	10.80	1.96	12.59
98-Other Passive Leisure	9.72	25.02	17.24	57.21	15.28	47.86
99-Travel: Passive Leisure	1.26	5.44	1.32	6.80	1.72	9.87

Source: Hill, 1985.



Table 15A-6. Weighted Mean Hours Per Week by Gender: 87 Activities and 10 Subtotals

Activity	Men N=410		Women N=561		Men and women N=971	
	Mean	Std. dev.	Mean	Std. dev.	Mean	Std. dev.
01 - Normal work	29.78	20.41	14.99	17.62	21.82	20.33
02 - Unemployment acts	0.14	1.06	0.08	0.75	0.11	0.90
05 - Second job	0.73	3.20	0.17	1.62	0.43	2.49
06 - Lunch at work 1.08	1.43	0.65	1.21	0.85	1.33	
07 - Before/after work	0.51	1.27	0.23	0.69	0.36	1.01
08 - Coffee breaks 0.57	1.05	0.36	1.03	0.46	1.04	
09 - Travel: to/from work	2.98	2.87	1.45	2.17	2.16	2.63
10 - Meal preparation	1.57	2.61	7.25	5.04	4.63	4.98
11 - Meal cleanup	0.33	0.83	2.30	2.19	1.39	1.97
12 - Indoor cleaning	0.85	2.01	5.03	5.05	3.10	4.46
13 - Outdoor cleaning	1.59	3.59	0.56	1.59	1.03	2.75
14 - Laundry	0.13	0.72	2.44	3.34	1.38	2.75
16 - Repairs/maintenance	2.14	4.29	0.68	3.43	1.35	3.92
17 - Gardening/pet care	0.94	2.78	1.00	2.19	0.97	2.48
19 - Other household	0.92	2.42	0.72	1.84	0.81	2.13
20 - Baby care	0.24	1.20	0.90	3.04	0.60	2.40
21 - Child care	0.24	0.78	0.99	2.11	0.64	1.68
22 - Helping/teaching	0.07	0.61	0.15	0.76	0.11	0.70
23 - Reading/talking	0.07	0.35	0.30	0.86	0.19	0.68
24 - Indoor playing 0.13	0.69	0.18	0.82	0.16	0.76	
25 - Outdoor playing	0.06	0.37	0.12	0.72	0.09	0.58
26 - Medical care - child	0.01	0.09	0.09	0.67	0.05	0.50
27 - Babysitting/other	0.14	0.78	0.64	2.58	0.41	1.98
29 - Travel: child care	0.23	0.67	0.50	1.21	0.38	1.00
30 - Everyday shopping	1.45	2.18	2.78	3.25	2.17	2.89
31 - Durables/house shopping	0.19	1.39	0.08	0.51	0.13	1.01
32 - Personal care services	0.06	0.42	0.35	1.14	0.22	0.90
33 - Medical appointments	0.15	0.75	0.37	1.63	0.27	1.31
34 - Govt/financial services	0.15	0.44	0.19	0.61	0.17	0.54
35 - Repair services 0.11	0.45	0.17	0.78	0.14	0.65	
37 - Other services 0.11	0.61	0.13	0.61	0.12	0.61	
38 - Errands	0.04	0.41	0.06	0.68	0.05	0.57
39 - Travel: goods/services	1.60	2.02	2.14	2.17	1.89	2.12

(Continued on the following page)



Appendix 15A

Table 15A-6. Weighted Mean Hours Per Week by Gender: 87 Activities and 10 Subtotals (continued)

Activity	Men N=410		Women N=561		Men and women N=971	
	Mean	Std. dev.	Mean	Std. dev.	Mean	Std. dev.
40 - Washing/dressing	4.33	2.39	5.43	3.24	4.92	2.93
41 - Medical care - adults	0.09	0.67	0.18	1.00	0.14	0.86
42 - Help and care	1.02	2.84	1.30	3.04	1.17	2.95
43 - Meals at home	6.59	3.87	6.32	3.53	6.44	3.69
44 - Meals out	2.72	3.48	2.24	2.73	2.46	3.10
45 - Night sleep	55.76	8.43	56.74	8.49	56.29	8.47
46 - Naps/resting 2.94	5.18	3.19	4.70	3.08	4.93	
48 - N.A. activities	1.77	6.12	1.99	5.70	1.89	5.89
49 - Travel: personal	2.06	2.59	1.61	2.51	1.82	2.56
50 - Students' classes	0.92	4.00	0.38	2.51	0.63	3.29
51 - Other classes	0.23	1.68	0.15	1.05	0.18	1.38
54 - Homework	0.76	3.48	0.38	1.87	0.56	2.74
56 - Other education	0.11	0.86	0.02	0.22	0.06	0.61
59 - Travel: education	0.29	1.07	0.16	1.06	0.22	1.07
60 - Professional/union organizations	0.04	0.46	0.04	0.62	0.04	0.55
61 - Identity organizations	0.14	0.97	0.18	1.55	0.16	1.31
62 - Political/citizen organizations	0.01	0.08	0.02	0.15	0.01	0.12
63 - Volunteer/helping organizations	0.02	0.32	0.14	1.05	0.09	0.80
64 - Religious groups	0.38	1.82	0.41	1.61	0.40	1.71
65 - Religious practice	0.89	2.05	1.31	2.97	1.12	1.60
66 - Fraternal organizations	0.16	1.17	0.05	0.66	0.10	0.93
67 - Child/family organizations	0.10	0.88	0.21	1.33	0.16	1.15
68 - Other organizations	0.34	2.40	0.32	1.53	0.32	1.98
69 - Travel: organizations	0.43	1.04	0.52	1.02	0.48	1.03
70 - Sports events	0.30	1.31	0.26	1.28	0.28	1.29
71 - Miscellaneous events	0.07	0.52	0.08	0.59	0.07	0.56
72 - Movies	0.31	1.25	0.26	1.13	0.28	1.19
73 - Theatre	0.13	0.93	0.06	0.48	0.09	0.72
74 - Museums	0.04	0.37	0.03	0.35	0.03	0.36
75 - Visiting with others	4.24	5.72	5.84	6.42	5.10	6.16
76 - Parties	0.64	2.05	0.44	1.65	0.53	1.84
77 - Bars/lounges 0.71	2.21	0.46	2.09	0.57	2.15	
78 - Other events 0.12	0.72	0.18	1.18	0.15	0.99	
79 - Travel: events/social	1.40	1.82	1.26	1.67	1.32	1.74

(Continued on the following page)



Table 15A-6. Weighted Mean Hours Per Week by Gender: 87 Activities and 10 Subtotals (continued)

Activity	Men N=410		Women N=561		Men and women N=971	
	Mean	Std. dev.	Mean	Std. dev.	Mean	Std. dev.
80 - Active sports	1.05	2.62	0.50	1.68	0.76	2.18
81 - Outdoors	1.49	4.59	0.48	1.67	0.94	3.39
82 - Walking/biking	0.52	1.31	0.23	0.98	0.36	1.16
83 - Hobbies	0.69	3.88	0.06	0.43	0.35	2.67
84 - Domestic crafts	0.30	1.59	2.00	4.72	1.21	3.93
85 - Art/literature 0.05	0.45	0.13	1.03	0.09	0.81	
86 - Music/drama/dance	0.06	0.49	0.07	0.47	0.07	0.48
87 - Games	0.60	2.00	0.99	3.16	0.81	2.69
88 - Classes/other	0.41	1.75	0.28	1.50	0.34	1.62
89 - Travel: active leisure	0.76	1.91	0.43	1.43	0.58	1.68
90 - Radio	0.39	1.40	0.39	1.55	0.39	1.49
91 - TV	14.75	12.14	13.95	10.67	14.32	11.38
92 - Records/tapes	0.46	2.35	0.33	2.13	0.39	2.23
93 - Reading books	0.37	1.52	0.56	1.83	0.47	1.70
94 - Reading magazines/N.A.	1.32	2.81	1.97	3.67	1.67	3.32
95 - Reading newspapers	1.86	2.72	1.47	2.27	1.65	2.49
96 - Conversations	1.61	2.19	2.18	2.74	1.91	2.52
97 - Letters	0.20	1.06	0.31	1.12	0.26	1.10
98 - Other passive leisure	1.68	3.53	1.41	3.32	1.53	3.42
99 - Travel: passive leisure	0.18	0.49	0.13	0.49	0.15	0.49

Source: Hill, 1985.



**Appendix 15A**

Table 15A-7. Ranking of Occupations by Median Years of Occupational Tenure

Occupation	Median years of occupational tenure
Barbers	24.8
Farmers, except horticultural	21.1
Railroad conductors and yardmasters	18.4
Clergy	15.8
Dentists	15.7
Telephone line installers and repairers	15.0
Millwrights	14.8
Locomotive operating occupations	14.8
Managers; farmers, except horticultural	14.4
Telephone installers and repairers	14.3
Airplane pilots and navigators	14.0
Supervisors: police and detectives	13.8
Grader, dozer, and scraper operators	13.3
Tailors	13.3
Civil engineers	13.0
Crane and tower operators	12.9
Supervisors, n.e.c.	12.9
Teachers, secondary school	12.5
Teachers, elementary school	12.4
Dental laboratory and medical appliance technicians	12.3
Separating, filtering, and clarifying machine operators	12.1
Tool and die makers	12.0
Lathe and turning machine operators	11.9
Machinists	11.9
Pharmacists	11.8
Stationary engineers	11.7
Mechanical engineers	11.4
Chemists, except biochemists	11.1
Inspectors, testers, and graders	11.0
Electricians	11.0
Operating engineers	11.0
Radiologic technicians	10.9
Electrical power installers and repairers	10.8
Supervisors; mechanics and repairers	10.7
Heavy equipment mechanics	10.7
Bus, truck, and stationary engine mechanics	10.7
Physicians	10.7
Construction inspectors	10.7
Cabinet makers and bench carpenters	10.6
Industrial machinery repairers	10.6
Automobile body and related repairers	10.4

(Continued on the following page)



Table 15A-7. Ranking of Occupations by Median Years of Occupational Tenure (continued)

---

Occupation	Median years of occupational tenure
Electrical and electronic engineers	10.4
Plumbers, pipefitters, and steamfitters	10.4
Licensed practical nurses	10.3
Brickmasons and stonemasons	10.2
Truck drivers, heavy	10.1
Tile setters, hard and soft	10.1
Lawyers	10.1
Supervisors: production occupations	10.1
Administrators, education and related fields	10.1
Engineers, n.e.c.	10.0
Excavating and loading machine operators	10.0
Firefighting occupations	10.0
Aircraft engine mechanics	10.0
Police and detectives, public service	9.7
Counselors, educational and vocational	9.7
Architects	9.6
Structural metal workers	9.6
Aerospace engineers	9.6
Miscellaneous material moving equipment operators	9.4
Dental hygienists	9.4
Automobile mechanics	9.3
Registered nurses	9.3
Speech therapists	9.3
Binding and twisting machine operators	9.3
Managers and administrators, n.e.c.	9.1
Personnel and labor relations managers	9.0
Office machine repairer	9.0
Electronic repairers, commercial and industrial equipment	9.0
Welders and cutters	9.0
Punching and stamping press machine operators	9.0
Sheet metal workers	8.9
Administrators and officials, public administration	8.9
Hairdressers and cosmetologists	8.9
Industrial engineers	8.9
Librarians	8.8
Inspectors and compliance officers, except construction	8.8
Upholsterers	8.6
Payroll and timekeeping clerks	8.6
Furnace, kiln, and oven operators, except food	8.6
Surveying and mapping technicians	8.6
Chemical engineers	8.6

---

(continued on the following page)





***Appendix 15A***

Table 15A-7. Ranking of Occupations by Median Years of Occupational Tenure (continued)

Occupation	Median years of occupational tenure
Sheriffs, bailiffs, and other law enforcement officers	8.6
Concrete and terrazzo finishers	8.6
Sales representatives, mining, manufacturing, and wholesale	8.6
Supervisors: general office	8.6
Specified mechanics and repairers, n.e.c.	8.5
Stenographers	8.5
Typesetters and compositors	8.5
Financial managers	8.4
Psychologists	8.4
Teachers: special education	8.4
Statistical clerks	8.3
Designers	8.3
Water and Sewage Treatment plant operators	8.3
Printing machine operators	8.2
Heating, air conditioning, and refrigeration mechanics	8.1
Supervisors; distribution, scheduling, and adjusting clerks	8.1
Insurance sales occupations	8.1
Carpenters	8.0
Public transportation attendants	8.0
Drafting occupations	8.0
Butchers and meatcutters	8.0
Miscellaneous electrical and electronic equipment repairers	7.9
Dressmakers	7.9
Musicians and composers	7.9
Supervisors and proprietors; sales occupations	7.9
Painters, Sculptors, craft-artists, and artist printmakers	7.9
Mechanics and repairers, not specified	7.7
Engineering technicians, n.e.c.	7.7
Clinical laboratory technologists and technicians	7.7
Purchasing managers	7.7
Purchasing agents and buyers, n.e.c.	7.7
Photographers	7.6
Chemical technicians	7.6
Managers; properties and real estate	7.6
Accountants and auditors	7.6
Religious workers, n.e.c.	7.6
Secretaries	7.5
Social workers	7.5
Operations and systems researchers and analysts	7.4
Postal clerks, except mail carriers	7.4
Managers; marketing, advertising, and public relations	7.3

(continued on the following page)



Table 15A-7. Ranking of Occupations by Median Years of Occupational Tenure (continued)

Occupation	Median years of occupational tenure
Farm workers	7.3
Managers; medicine and health	7.2
Data processing equipment repairers	7.2
Bookkeepers, accounting and auditing clerks	7.1
Grinding, abrading, buffing, and polishing machine operators	7.0
Management related occupations, n.e.c.	7.0
Supervisors; cleaning and building service workers	7.0
Management analysts	7.0
Science technicians, n.e.c.	7.0
Mail carriers, postal service	7.0
Knitting, looping, taping, and weaving machine operators	6.9
Electrical and electronic technicians	6.9
Painting and paint spraying machine operators	6.9
Postsecondary teachers, subject not specified	6.8
Crossing guards	6.8
Inhalation therapists	6.7
Carpet installers	6.7
Computer systems analysts and scientists	6.6
Other financial officers	6.6
Industrial truck and tractor equipment operators	6.6
Textile sewing machine operators	6.6
Correctional institution officers	6.5
Teachers, prekindergarten and kindergarten	6.4
Supervisors; financial records processing	6.4
Miscellaneous Textile machine operators	6.4
Production inspectors, checkers, and examiners	6.3
Actors and directors	6.3
Health technologists and technicians, n.e.c.	6.3
Miscellaneous machine operators, n.e.c.	6.2
Private household cleaners, and servants	6.2
Buyers, wholesale and retail trade, excluding farm products	6.0
Real estate sales occupations	6.0
Electrical and electronic equipment assemblers	6.0
Bus drivers	6.0
Editors and reporters	6.0
Laundering and dry cleaning machine operators	6.0
Meter readers	5.9
Painters, construction and maintenance	5.9
Driver-sales workers	5.9
Teachers, n.e.c.	5.9
Order clerks	5.8
Physicians' assistants	5.8

(continued on the following page)



*Appendix 15A*

Table 15A-7. Ranking of Occupations by Median Years of Occupational Tenure (continued)

Occupation	Median years of occupational tenure
Billing clerks	5.8
Drywall installers	5.7
Construction trades, n.e.c.	5.7
Telephone operators	5.7
Authors	5.6
Nursing aides, orderlies, and attendants	5.6
Dental assistants	5.6
Timber cutting and logging occupations	5.5
Molding and casting machine operators	5.5
Miscellaneous hand-working occupations	5.5
Production coordinators	5.5
Public relations specialists	5.5
Personnel clerks, except payroll and bookkeeping	5.4
Assemblers	5.4
Securities and financial services sales occupations	5.4
Salesworkers, furniture and home furnishings	5.4
Insurance adjusters, examiners, and investigators	5.3
Pressing machine operators	5.3
Roofers	5.3
Graders and sorters, except agricultural	5.3
Supervisors; related agricultural occupations	5.2
Typists	5.2
Supervisors; motor vehicle operators	5.2
Personnel, training, and labor relations specialists	5.2
Legal assistants	5.2
Physical therapists	5.2
Advertising and related sales occupations	5.1
Records clerks	5.1
Economists	5.1
Technicians, n.e.c.	5.0
Expeditors	5.0
Sales occupations, other business services	4.9
Computer operators	4.8
Computer programmers	4.8
Investigators and adjusters, except insurance	4.8
Underwriters	4.8
Salesworkers, parts	4.8
Artists, performers, and related workers, n.e.c.	4.8
Teachers' aides	4.6
Maids and housemen	4.6
Sawing machine operators	4.6
Machine operators, not specified	4.5
Weighers, measurers, and checkers	4.5

(continued on the following page)



Table 15A-7. Ranking of Occupations by Median Years of Occupational Tenure (continued)

Occupation	Median years of occupational tenure
Traffic, shipping, and receiving clerks	4.5
Salesworkers, hardware and building supplies	4.5
Biological technicians	4.4
Athletes	4.4
Bill and account collectors	4.4
Taxicab drivers and chauffeurs	4.4
Slicing and cutting machine operators	4.3
Administrative support occupations, n.e.c.	4.3
Mixing and blending machine operators	4.3
Waiters and waitresses	4.2
Janitors and cleaners	4.2
Production helpers	4.1
General office clerks	4.0
Machine feeders and offbearers	3.9
Interviewers	3.9
Bartenders	3.9
Eligibility clerks, social welfare	3.9
Bank tellers	3.8
Cooks, except short-order	3.8
Health aides, except nursing	3.7
Laborers, except construction	3.7
Welfare service aides	3.7
Salesworkers, motor vehicles and boats	3.7
Cost and rate clerks	3.6
Construction laborers	3.6
Hand packers and packagers	3.5
Transportation ticket and reservation agents	3.5
Animal caretakers, except farm	3.5
Photographic process machine operators	3.5
Freight, stock, and material movers, hand, n.e.c.	3.4
Data-entry keyers	3.4
Bakers	3.4
Dispatchers	3.3
Guards and police, except public service	3.3
Packaging and filling machine operators	3.3
Receptionists	3.3
Library clerks	3.3
Truckdrivers, light	3.2
Salesworkers, radio, television, hi-fi, and appliances	3.2
Salesworkers, apparel	3.1
Sales counter clerks	3.1
Salesworkers, other commodities	3.1

(continued on the following page)



Appendix 15A

Table 15A-7. Ranking of Occupations by Median Years of Occupational Tenure (continued)

Occupation	Median years of occupational tenure
Small engine repairers	3.1
Supervisors, food preparation and service occupations	3.0
Health record technologists and technicians	2.9
Helpers, construction trades	2.9
Attendants, amusement and recreation facilities	2.8
Street and door-to-door salesworkers	2.7
Child-care workers, private household	2.7
Child-care workers, except private household	2.7
Information clerks, n.e.c.	2.7
Hotel clerks	2.7
Personal service occupations, n.e.c.	2.7
Salesworkers, shoes	2.6
Garage and service station related occupations	2.6
Short-order cooks	2.5
File clerks	2.5
Cashiers	2.4
Mail clerks, except postal service	2.3
Miscellaneous food preparation occupations	2.3
News vendors	2.3
Vehicle washers and equipment cleaners	2.3
Messengers	2.3
Kitchen workers, food preparation	2.1
Stock handlers and baggers	1.9
Waiters and waitresses assistants	1.7
Food counter, fountain, and related occupations	1.5

<sup>a</sup> n.e.c. - not elsewhere classified

Source: Carey, 1988.



**APPENDIX 15B**

**ACTIVITY PATTERNS CODES AND OCCUPATIONAL TENURE DATA**



Table 15B-1. Annual Geographical Mobility Rates, by Type of Movement for Selected 1-Year Periods: 1960-1992 (numbers in thousands)

Mobility period	Total movers	Residing in the United States at beginning of period						Residing outside the United States at the beginning of period
		Total	Different house, same county	Different County				
				Total	Same State	Different State	Different Region	
<b>NUMBER</b>								
1991-92	42,800	41,545	26,587	14,957	7,853	7,105	3,285	1,255
1990-91	41,539	40,154	25,151	15,003	7,881	7,122	3,384	1,385
1989-90	43,381	41,821	25,726	16,094	8,061	8,033	3,761	1,560
1988-89	42,620	41,153	26,123	15,030	7,949	7,081	3,258	1,467
1987-88	42,174	40,974	26,201	14,772	7,727	7,046	3,098	1,200
1986-87	43,693	42,551	27,196	15,355	8,762	6,593	3,546	1,142
1985-86	43,237	42,037	26,401	15,636	8,665	6,791	3,778	1,200
1984-85	46,470	45,043	30,126	14,917	7,995	6,921	3,647	1,427
1983-84	39,379	38,300	23,659	14,641	8,198	6,444	3,540	1,079
1982-83	37,408	36,430	22,858	13,572	7,403	6,169	3,192	978
1981-82	38,127	37,039	23,081	13,959	7,330	6,628	3,679	1,088
1980-81	38,200	36,887	23,097	13,789	7,614	6,175	3,363	1,313
1970-71	37,705	36,161	23,018	13,143	6,197	6,946	3,936	1,544
1960-61	36,533	35,535	24,289	11,246	5,493	5,753	3,097	988
<b>PERCENT</b>								
1991-92	17.3	16.8	10.7	6.0	3.2	2.9	1.3	0.5
1990-91	17.0	16.4	10.3	6.1	3.2	2.9	1.4	0.6
1989-90	17.9	17.3	10.6	6.6	3.3	3.3	1.6	0.6
1988-89	17.8	17.2	10.9	6.3	3.3	3.0	1.4	0.6
1987-88	17.8	17.3	11.0	6.2	3.3	3.0	1.3	0.5
1986-87	18.6	18.1	11.6	6.5	3.7	2.8	1.5	0.5
1985-86	18.6	18.0	11.3	6.7	3.7	3.0	1.6	0.5
1984-85	20.2	19.6	13.1	6.5	3.5	3.0	1.6	0.6
1983-84	17.3	16.8	10.4	6.4	3.6	2.8	1.6	0.5
1982-83	16.6	16.1	10.1	6.0	3.3	2.7	1.4	0.4
1981-82	17.0	16.6	10.3	6.2	3.3	3.0	1.6	0.5
1980-81	17.2	16.6	10.4	6.2	3.4	2.8	1.5	0.6
1970-71	18.7	17.9	11.4	6.5	3.1	3.4	2.0	0.8
1960-61	20.6	20.0	13.7	6.3	3.1	3.2	1.7	0.6

Source: U.S. Bureau of Census, 1993.



Table 15B-2. Mobility of the Resident Population by State: 1980

Region, division, and state	Persons 5 years old, and over <sup>b</sup> 1980 (1,000)	Same house in 1980 as 1975	Percent distribution - residence in 1975 <sup>a</sup>		
			Different house, same county	Different county, same state	Different county, different state
United States	210,323	53.6	25.1	9.8	9.7
Northeast	46,052	61.7	22.3	8.0	6.1
New England	11,594	59.1	23.4	6.7	9.2
Maine	1,047	56.9	24.0	7.5	10.8
New Hampshire	857	51.6	22.8	6.2	18.5
Vermont	476	54.4	23.9	6.5	14.3
Massachusetts	5,398	61.0	22.7	7.6	7.0
Rhode Island	891	60.5	23.9	5.0	8.7
Connecticut	2,925	59.0	24.4	5.5	9.3
Middle Atlantic	34,458	62.6	21.9	8.4	5.0
New York	16,432	61.5	22.6	9.3	3.8
New Jersey	6,904	61.5	20.0	8.6	7.8
Pennsylvania	11,122	65.0	22.0	7.1	5.2
Midwest	54,513	55.4	26.4	10.2	7.0
East North Central	38,623	56.0	27.4	9.6	6.0
Ohio	10,015	56.7	27.9	9.0	5.7
Indiana	5,074	54.8	27.5	9.6	7.6
Illinois	10,593	55.5	28.5	8.1	6.1
Michigan	8,582	56.4	26.2	11.3	5.1
Wisconsin	4,360	56.2	25.5	11.0	6.7
West North Central	15,890	53.9	24.0	11.8	9.4
Minnesota	3,770	55.6	22.8	13.3	7.3
Iowa	2,693	55.6	25.0	10.9	7.9
Missouri	4,564	54.0	24.1	11.8	9.4
North Dakota	598	51.7	23.1	11.4	12.7
South Dakota	633	52.9	23.2	12.1	11.1
Nebraska	1,448	53.1	24.4	11.0	10.5
Kansas	2,184	50.2	25.1	10.7	12.6

(Continued on the following page)





## Appendix 15B

Table 15B-2. Mobility of the Resident Population by State: 1980 (continued)

Region, division, and state	Persons 5 years old, and over <sup>b</sup> 1980 (1,000)	Same house in 1980 as 1975	Percent distribution - residence in 1975 <sup>a</sup>		
			Different house, same county	Different county, same state	Different county, different state
<u>South</u>	69,880	52.4	24.1	10.0	12.0
South Atlantic	34,498	52.7	22.4	9.7	13.6
Delaware	555	57.0	26.3	2.0	13.3
Maryland	3,947	55.5	21.9	10.3	10.4
District of Columbia	603	58.2	22.7	NA	16.3
Virginia	4,991	51.0	17.9	15.0	13.9
West Virginia	1,806	60.9	23.4	6.6	8.6
North Carolina	5,476	56.9	23.5	8.9	9.8
South Carolina	2,884	57.5	22.3	7.7	11.5
Georgia	5,052	52.5	22.8	12.2	11.5
Florida	9,183	46.2	23.7	7.8	19.6
East South Central	13,556	56.0	25.9	7.9	9.5
Kentucky	3,379	54.4	27.2	8.6	9.0
Tennessee	4,269	54.2	27.2	7.4	10.6
Alabama	3,601	57.6	25.3	7.4	8.9
Mississippi	2,307	59.0	22.5	8.6	9.2
West South Central	21,826	49.6	25.6	11.8	11.0
Arkansas	2,113	53.1	24.8	9.1	12.4
Louisiana	3,847	57.0	24.3	9.2	8.4
Oklahoma	2,793	47.6	24.9	12.3	13.7
Texas	13,074	47.3	26.2	12.9	11.0
<u>West</u>	39,879	43.8	28.3	11.0	13.4
Mountain	10,386	42.7	25.1	9.1	21.1
Montana	722	47.3	24.5	12.3	15.0
Idaho	852	44.4	24.7	9.5	20.0
Wyoming	425	38.4	23.6	8.6	28.3
Colorado	2,676	39.8	22.7	14.8	20.6
New Mexico	1,188	50.3	23.2	7.2	17.4
Arizona	2,506	41.9	27.1	5.0	23.9
Utah	1,272	45.8	27.8	8.4	16.0
Nevada	745	34.8	27.4	3.6	31.5

(continued on the following page)



Table 15B-2. Mobility of the Resident Population by State: 1980 (continued)

Region, division, and state	Persons 5 years old, and over <sup>b</sup> 1980 (1,000)	Same house in 1980 as 1975	Percent distribution - residence in 1975 <sup>a</sup>		
			Different house, same county	Different county, same state	Different county, different state
Pacific	29,493	44.2	29.4	11.6	10.7
Washington	3,825	43.7	27.7	10.1	16.2
Oregon	2,437	41.4	26.6	13.4	16.9
California	21,980	44.6	30.2	12.1	8.5
Alaska	363	32.2	27.6	8.7	29.1
Hawaii	888	49.3	25.2	2.8	16.9

<sup>a</sup> Survey assessed changes in residence between 1975 and 1980.

<sup>b</sup> Includes persons residing abroad in 1975.

NA = not applicable.

Source: U.S. Bureau of the Census, Statistical Abstract, 1984.

## TABLE OF CONTENTS

	<u>Page No.</u>
16. CONSUMER PRODUCTS .....	1
16.1. BACKGROUND .....	1
16.2. KEY CONSUMER PRODUCTS USE STUDIES .....	1
16.3. RELEVANT CONSUMER PRODUCTS USE STUDY .....	4
<b>16.4. RECOMMENDATIONS</b> .....	<b>5</b>
16.5. REFERENCES FOR CHAPTER 16 .....	5

**16. CONSUMER PRODUCTS****16.1. BACKGROUND**

Consumer products may contain toxic or potentially toxic chemical constituents to which humans may be exposed as a result of their use. For example, methylene chloride and other solvents and carriers are common in consumer products and may have human health concerns. Potential pathways of exposure to consumer products or chemicals released from consumer products during use occur via ingestion, inhalation, and dermal contact. Exposure assessments that address consumer products involve characterization of these potential exposure pathways and calculating exposure or dose (based on exposure pathway) of chemical substances released during use of consumer products. In order to estimate specific-pathway exposure for consumer products or their components, the following information is needed: amount of product used; concentration of product in each type of activity; percent weight of chemical present in product; duration and frequency of use or activity; and for dermal exposure, the amount of solution on skin after exposure (Hakkinen et al., 1991; U.S. EPA, 1987).

This chapter presents information on the amount of product used, frequency of use, and duration of use for various consumer products typically found in consumer households. All tables that present information for these consumer products are located at the end of this chapter. U.S. EPA (1987) has compiled a comprehensive list of consumer products found in typical American households. This list of consumer products is presented in Table 16-1. It should be noted that this chapter does not provide an exhaustive treatment of all consumer products, but rather provides some background and data that can be utilized in an exposure assessment. Also, the data presented may not capture information needed to assess the highly exposed population (e.g., consumers who use commercial/ industrial strength products at home). The studies presented in the following sections represent readily available surveys for which data were collected on the frequency and duration of use and amount of use of cleaning products, painting products, household solvent products, cosmetic and other personal care products, household equipment, pesticides, and tobacco. The studies have been classified as either key or relevant based on their applicability to exposure assessment needs.

The reader is also referred to a document developed by the U.S. EPA, Office of Toxic Substances: *Standard Scenarios for Estimating Exposure to Chemical Substances During Use of Consumer Products - Volumes*

*I and II* (U.S. EPA, 1986). This document presents data and supporting information required to assess consumer exposure to constituents in household cleaners and components of adhesives. Information presented includes a description of standard scenarios selected to represent upper bound exposures for each product. Values are also presented for parameters that are needed to estimate exposure for defined exposure routes and pathways assumed for each scenario.

An additional reference is the Simmons Market Research Bureau (SMRB), "Simmons Study of Media and Markets." This document provides an example of marketing data that are available that may be useful in assessing exposure to selected products. The reports are published annually. Data are collected on the buying habits of the U.S. populations over the past 12 months. This information is collected for over 1,000 consumer products. Data are presented on frequency of use, total number of buyers in each use category, and selected demographics. The consumer product data are presented according to the "buyer" and not necessarily according to the "user" (actively exposed person). It may be necessary to adjust the data to reflect potential uses in a household. The reports are available for purchase from the Simmons Market Research Bureau, (212) 916-8970. Appendix Table 16A-1 presents a list of product categories in SMRB for which information is available.

**16.2. KEY CONSUMER PRODUCTS USE STUDIES**

*Westat (1987a) - Household Solvent Products: A National Usage Survey* - Westat (1987a) conducted a nationwide survey to determine consumer exposure to common household products believed to contain methylene chloride or its substitutes (trichloroethane, trichloroethylene, carbon tetrachloride, perchloroethylene, and 1,1,1,2,2,2- trichlorotrifluoroethane). The survey methodology was comprised of three phases. In the first phase, the sample population was generated by using a random digit dialing (RDD) procedure. Using this procedure, telephone numbers of households were randomly selected by utilizing an unbiased, equal probability of selection method, known as the "Waksberg Method" (Westat, 1987a). After the respondents in the selected households (18 years and older) agreed to participate in the survey, the second phase was initiated. It involved a mailout of questionnaires and product pictures to each respondent. In the third phase, a telephone follow-up call was made to those respondents who did not respond to the mailed questionnaire within a 4-week period. The same



questionnaire was administered over the telephone to participants who did not respond to the mailed questionnaire. Of the 6,700 individuals contacted for the survey, 4,920 individuals either responded to the mailed questionnaire or to a telephone interview (a response rate of 73 percent). Survey questions included how often the products were used in the last 12 months; when they were last used; how much time was spent using a product (per occasion or year), and the time the respondent remained in the room after use; how much of a product was used per occasion or year; and what protective measures were used (Westat, 1987a).

Thirty-two categories of common household products were included in the survey and are presented in Table 16-2. Tables 16-2, 16-3, 16-4, and 16-5 provide means, medians, and percentile rankings for the following variables: frequency of use, exposure time, amount of use, and time exposed after use.

An advantage of this study is that the random digit dialing procedure (Waksberg Method) used in identifying participants for this survey enabled a diverse selection of a representative, unbiased, sample of the U.S. population (Westat 1987a). Also, empirical data generated from this study will provide more accurate calculations of human exposure to consumer household products than estimates previously used. However, a limitation associated with this study is that the data generated were based on recall behavior. Another limitation is that extrapolation of these data to long-term use patterns may be difficult.

*Abt (1992) - Methylene Chloride Consumer Use Study Survey Findings* - As part of a plan to assess the effectiveness of labeling of consumer products containing methylene chloride, Abt conducted a telephone survey of nearly five thousand households (Abt, 1992). The survey was conducted in April and May of 1991. Three classes of products were of concern: paint strippers, non-automotive spray paint, and adhesive removers. The survey paralleled a 1986 consumer use survey sponsored jointly by Abt and the U.S. EPA. Results of the survey were the following (Abt, 1992):

- Compared to the 1986 findings, a significantly smaller proportion of current survey respondents used a paint stripper, spray paint, or adhesive remover.
- The proportion of the population who used the three products recently (within the past year) decreased substantially.

- Those who used the products reported a significantly longer time since their last use.
- For all three products, the reported amount used per year was significantly higher in the current survey.

The survey was conducted to estimate the percent of the U.S. adult population using paint remover, adhesive remover, and non-automotive spray paint. In addition, an estimate of the population using these products containing methylene chloride was determined. A survey questionnaire was developed to collect product usage data and demographic data. The survey sample was generated using a RDD technique.

A total of 4,997 product screener interviews were conducted for the product interview sections; the number of respondents were: 381 for paint strippers, 58 for adhesive removers, and 791 for non-automotive spray paint. Survey responses were weighted to allow estimation at the level of the total U.S. population (Abt, 1992). A follow-up mail survey was also conducted using a short questionnaire. Respondents who had used the product in the past year or had purchased the product in the past 2 years and still had the container were asked to respond to the questionnaire (Abt, 1992). Of the mail questionnaires (527) sent out, 259 were returned. The questionnaire responses included 67 on paint strippers, 6 on adhesive removers, and 186 on non-automotive spray paint. Results of the survey are presented in Tables 16-6 through 16-11 (N's are unweighted). Data are presented for recent users. Recent users were defined as persons who have used the product within the last year of the survey or who have purchased the product in the past 2 years.

An advantage of this survey is that the survey population was large and the survey responses were weighted to represent the U.S. population. In addition, the survey was designed to collect data for frequency of product use and amount of product used by gender. A limitation of the survey is that the data were generated based on recall behavior. Extrapolation of these data to accurately reflect long-term use patterns may be difficult.

*Westat (1987b) - National Usage Survey of Household Cleaning Products* - Westat (1987b) collected usage data from a nationwide survey to assess the magnitude of exposure of consumers to various products used when performing certain household cleaning tasks. The survey was conducted between the middle of November, 1985 to the middle of January, 1986.



Telephone interviews were conducted with 193 households. According to Westat (1987b), the resulting response rate for this survey was 78 percent. The Waksberg method discussed previously in the Westat (1987a) study was also used in randomly selecting telephone numbers employed in the Westat (1987b) survey. The survey was designed to obtain information on cleaning activities performed in the interior of the home during the previous year. The person who did the majority of the cleaning in the kitchen and bathroom areas of each household was interviewed. Of those respondents, the primary cleaner was female in 160 households (83 percent) and male in 30 households (16 percent); the sex of the respondents in three remaining households was not ascertained (Westat, 1987b). Data obtained from the survey included the frequency of performing 14 different cleaning tasks; the amount of time (duration) spent at each task; the cleaning product most frequently used; the type of product (liquid, powder, aerosol or spray pump) used; and the protective measures taken during cleaning such as wearing rubber gloves or having a window open or an exhaust fan on (Westat, 1987b).

The survey data are presented in Tables 16-12 through 16-16. Table 16-12 presents the mean and median total exposure time of use for each cleaning task and the product type preferred for each task. The percentile rankings for the total time exposed to the products used for 14 cleaning tasks are presented in Table 16-13. The mean and percentile rankings of the frequency in performing each task are presented in Table 16-14. Table 16-15 shows the mean and percentile rankings for exposure time per event of performing household tasks. The mean and percentile rankings for total number of hours spent per year using the top 10 product groups are presented in Table 16-16.

Westat (1987b) randomly selected a subset of 30 respondents from the original survey and reinterviewed them during the first two weeks of March, 1986 as a reliability check on the recall data obtained from the original phone survey. Frequency and duration data for 3 of the original 14 cleaning tasks were obtained from the reinterviews. In a second effort to validate the phone survey, 50 respondents of the original phone survey participated in a four-week diary study (between February and March, 1986) of 8 of the 14 cleaning tasks originally studied. The diary approach assessed the validity of using a one-time telephone survey to determine usual cleaning behavior (Westat, 1987b). The data (i.e., frequency and duration) obtained from the reinterviews and the diary approach were lower than the data from the original telephone survey. The data from the reinterviews and the

diary approach were more consistent with each other. Westat (1987b) attributed the significant differences in the data obtained from these surveys to seasonal changes rather than methodological problems.

A limitation of this survey is evident from the reliability and validity check of the data conducted by Westat (1987b). The data obtained from the telephone survey may reflect heavier seasonal cleaning because the survey was conducted during the holidays (November through January). Therefore, usage data obtained in this study may be biased and may represent upper bound estimates. Another limitation of this study is the small size of the sample population. An advantage of this survey is that the RDD procedure (Waksberg Method) used provides unbiased results of sample selection and reduces the number of unproductive calls. Another advantage of this study is that it provides empirical data on frequency and duration of consumer use, thereby eliminating best judgment or guesswork.

*Westat (1987c) - National Household Survey of Interior Painters* - Westat (1987c) conducted a study between November, 1985 and January, 1986 to obtain usage information to estimate the magnitude of exposure of consumers to different types of painting and painting related products used while painting the interior of the home. Seven-hundred and seventy-seven households were sampled to determine whether any household member had painted the interior of the home during the last 12 months prior to the survey date. Of the sampled households, 208 households (27 percent) had a household member who had painted during the last 12 months. Based on the households with primary painters, the response rate was 90 percent (Westat, 1987c). The person in each household who did most of the interior painting during the last 12 months was interviewed over the telephone. The RDD procedure (Waksberg Method) previously described in Westat (1987a) was used to generate sample blocks of telephone numbers in this survey. Questions were asked on frequency and time spent for interior painting activities; the amount of paint used; and protective measures used (i.e., wearing gloves, hats, and masks or keeping a window open) (Westat, 1987c). Fifty-three percent of the primary painters in the households interviewed were male, 46 percent were female, and the sex of the remaining 1 percent was not ascertained. Three types of painting products were used in this study; latex paint, oil-based paint, and wood stains and varnishes. Of the respondents, 94.7 percent used latex paint, 16.8 percent used oil-based paint, and 20.2 percent used wood stains and varnishes.



Data generated from this survey are summarized in Tables 16-17, 16-18, and 16-19. Table 16-17 presents the mean, standard duration, and percentile rankings for the total exposure time for painting activity by paint type. Table 16-18 presents the mean and standard exposure time for the painting activity per occasion for each paint type. A "painting occasion" is defined as a time period from start to cleanup (Westat 1987c). Table 16-18 also presents the frequency and percentile rankings of painting occasions per year. Table 16-19 presents the total amount of paint used by interior painters.

In addition, 30 respondents from the original survey were reinterviewed in April 1986, as a reliability check on the recall data obtained from the original painting survey. There were no significant differences between the data obtained from the reinterviews and the original painting survey (Westat, 1987c).

An advantage of this survey, based on the reliability check conducted by Westat (1987c), is the stability in the painting data obtained. Another advantage of this survey is that the response rate was high (90 percent), therefore, minimizing non-response bias. Also, the Waksberg Method employed provides an unbiased equal probability method of RDD. A limitation of the survey is the data are based on 12-month recall and may not accurately reflect long-term use patterns.

*Tsang and Klepeis (1996) - National Human Activity Pattern Survey (NHAPS)* - The U.S. EPA collected information for the general population on the duration and frequency of selected activities and the time spent in selected microenvironments via 24-hour diaries. Over 9000 individuals from 48 contiguous states participated in NHAPS. The survey was conducted between October 1992 and September 1994. Individuals were interviewed to categorize their 24-hour routines (diaries) and/or answer follow-up exposure questions that were related to exposure events. Data were collected based on selected socioeconomic (gender, age, race, education, etc.) and geographic (census region, state, etc.) factors and time/season (day of week, month) (Tsang and Klepeis, 1996).

Data were collected for a maximum of 82 possible microenvironments and 91 different activities (Tsang and Klepeis, 1996). Respondents were also asked exposure-related follow up questions, mostly on air and water exposure pathways, on specific pollutant sources (paint, glue, etc.), or prolonged background activities (tobacco smoke, gas heaters, etc.) (Tsang and Klepeis, 1996).

As part of the survey, data were also collected on duration and frequency of use of selected consumer products. These data are presented in Tables 16-20 through 16-34. Distribution data are presented for selected percentiles (where possible). Other data are presented in ranges of time spent in an activity (e.g., working with or near a product being used) or ranges for the number of times an activity involving a consumer product was performed. Tables 16-20 through 16-34 provide duration and/or frequency data for the following categories: selected cosmetics and personal care items; household cleaners and other household products; household equipment; pesticides; and tobacco products.

The advantages of NHAPS is that the data were collected for a large number of individuals and are representative of the U.S. general population. In addition, frequency distributions of time spent and frequency of occurrence data for activities and locations are provided, when possible. Also, data on 9,386 different respondents are grouped by various socioeconomic, geographic, time/seasonal factors. A disadvantage of NHAPS is that means cannot be calculated for consumers who spent more than 60 or 120 minutes (depending on the activity) in an activity using a consumer product. Therefore, a good estimate of the high consumer activities cannot be captured.

### 16.3. RELEVANT CONSUMER PRODUCTS USE STUDY

*CTFA (1983) - Cosmetic, Toiletry, and Fragrance Association, Inc. - Summary of Results of Surveys of the Amount and Frequency of Use of Cosmetic Products by Women* - The Cosmetic, Toiletry, and Fragrance Association Inc. (CTFA, 1983), a major manufacturer and a market research bureau, conducted surveys to obtain information on frequency of use of various cosmetic products. Three surveys were conducted to collect data on the frequency of use of various cosmetic products and selected baby products. In the first of these three surveys CTFA (1983) conducted a one-week prospective survey of 47 female employees and relatives of employees between the ages of 13 and 61 years. In the second survey, a cosmetic manufacturer conducted a retrospective survey of 1,129 of its customers. The third survey was conducted by a market research bureau which sampled 19,035 female consumers nationwide over a 9-1/2 month period. Of the 19,035 females interviewed, responses from only 9,684 females were tabulated (CTFA, 1983). The third survey was designed to reflect the sociodemographic (i.e., age, income, etc) characteristics of the entire U.S. population.



The respondents in all three surveys were asked to record the number of times they used the various products in a given time period, i.e., a week, a day, a month, or a year (CTFA, 1983).

To obtain the average frequency of use for each cosmetic product, responses were averaged for each product in each survey. Thus, the averages were calculated by adding the reported number of uses per given time period for each product, dividing by the total number of respondents in the survey, and then dividing again by the number of days in the given time period (CTFA, 1983). The average frequency of use of cosmetic products was determined for both "users" and "non-users." The frequency of use of baby products was determined among "users" only. The upper 90th percentile frequency of use values were determined by eliminating the top ten percent most extreme frequencies of use. Therefore, the highest remaining frequency of use was recorded as the upper 90th percentile value (CTFA, 1983). Table 16-34 presents the amount of product used per application (grams) and the average and 90th percentile frequency of use per day for baby products and various cosmetic products for all the surveys.

An advantage of the frequency data obtained from the third survey (market research bureau) is that the sample population was more likely to be representative of the U.S. population. Another advantage of the third dataset is that the survey was conducted over a longer period of time when compared with the other two frequency datasets. Also, the study provided empirical data which will be useful in generating more accurate estimates of consumer exposure to cosmetic products. In contrast to the large market research bureau survey, the CTFA employee survey is very small and both that survey and the cosmetic company survey are likely to be biased toward high end users. Therefore, data from these two surveys should be used with caution.

#### **16.4. RECOMMENDATIONS**

Due to the large range and variation among consumer products and their exposure pathways, it is not feasible to specify recommended exposure values as has been done in other chapters of this handbook. The user is referred to the contents and references in the chapter to derive appropriate exposure factors. Table 16-35 summarizes the key and relevant studies in this chapter. In order to estimate consumer exposure to household products, several types of information are needed for the exposure equation. The information needed includes frequency and duration of use, amount of product used, percent weight of

the chemical of concern found in the product, and for dermal exposure, the amount of the solution on the skin after exposure. The studies of Westat (1987a, b, and c), (Abt, 1992), and Tsang and Klepeis (1996) provide information on amount, duration, and frequency of use of household products. The frequency and duration of use and amount of product used for some household and other consumer products can be obtained from Tables 16-2 through 16-34. Exposure to chemicals present in common household products can be estimated by utilizing data presented in these tables and the appropriate exposure equation. It should be noted that if these data are used to model indoor air concentrations, the values for time of use, time exposed after use, and frequency in the indoor air, should be the same values used in the dose equation for frequency and contact time for a given individual.

#### **16.5. REFERENCES FOR CHAPTER 16**

- Abt. (1992) Methylene chloride consumer products use survey findings. Prepared by Abt Associates, Inc. for the U.S. Consumer Product Safety Commission, Bethesda, MD.
- Cosmetic, Toiletry and Fragrance Association (CTFA). (1983). Summary of the results of surveys of the amount and frequency of use of cosmetic products by women. Prepared by Environ Corporation, Washington, DC for CFFA Inc., Washington, DC.
- Hakkinen, P.J.; Kelling, C.K.; Callender, J.C. (1991) Exposure assessment of consumer products: Human body weights and total body surface areas to use; and sources of data for specific products. *Veterinary and Human Toxicology* 1(33):61-65.
- Tsang, A.M.; Klepeis, N.E. (1996) Results tables from a detailed analysis of the National Human Activity Pattern Survey (NHAPS) response. Draft Report prepared for the U.S. Environmental Protection Agency by Lockheed Martin, Contract No. 68-W6-001, Delivery Order No. 13.
- U.S. EPA. (1986) Standard scenarios for estimating exposure to chemical substances during use of consumer products. Prepared by Versar, Inc. For the Office of Toxic Substances, Contract No. 68-02-3968.
- U.S. EPA. (1987) Methods for assessing exposure to chemical substances - Volume 7 - Methods for assessing consumer exposure to chemical substances. Washington, DC: Office of Toxic Substances. EPA Report No. 560/5-85-007.





Westat. (1987a) Household solvent products - a national usage survey. Under Subcontract to Battelle Columbus Div., Washington DC. Prepared for U.S. Environmental Protection Agency, Washington, DC. Available from NTIS, Springfield, VA. PB88-132881.

Westat. (1987b) National usage survey of household cleaning products. Prepared for U.S. Environmental Protection Agency, Office of Toxic Substances and Office of Pesticides and Toxic Substances, Washington, DC.

Westat. (1987c) National household survey of interior painters. Prepared for U.S. Environmental Protection Agency, Office of Toxic Substances and Office of Pesticides and Toxic Substances, Washington DC.



Table 16-1. Consumer Products Found in the Typical U.S. Household<sup>a</sup>

Consumer Product Category	Consumer Product
Cosmetics Hygiene Products	Adhesive bandages Bath additives (liquid) Bath additives (powder) Cologne/perfume/aftershave Contact lens solutions Deodorant/antiperspirant (aerosol) Deodorant/antiperspirant (wax and liquid) Depilatories Facial makeup Fingernail cosmetics Hair coloring/tinting products Hair conditioning products Hairsprays (aerosol) Lip products Mouthwash/breath freshener Sanitary napkins and pads Shampoo Shaving creams (aerosols) Skin creams (non-drug) Skin oils (non-drug) Soap (toilet bar) Sunscreen/suntan products Talc/body powder (non-drug) Toothpaste Waterless skin cleaners
Household Furnishings	Carpeting Draperies/curtains Rugs (area) Shower curtains Vinyl upholstery, furniture
Garment Conditioning Products	Anti-static spray (aerosol) Leather treatment (liquid and wax) Shoe polish Spray starch (aerosol) Suede cleaner/polish (liquid and aerosol) Textile water-proofing (aerosol)
Household Maintenance Products	Adhesive (general) (liquid) Bleach (household) (liquid) Bleach (see laundry) Candles Cat box litter Charcoal briquets Charcoal lighter fluid Drain cleaner (liquid and powder) Dishwasher detergent (powder) Dishwashing liquid Fabric dye (DIY) <sup>b</sup> Fabric rinse/softener (liquid)



Table 16-1. Consumer Products Found in the Typical U.S. Household<sup>a</sup> (continued)

Consumer Product Category	Consumer Product	
Household Maintenance Products (continued)	Fabric rinse/softener (powder)	
	Fertilizer (garden) (liquid)	
	Fertilizer (garden) (powder)	
	Fire extinguishers (aerosol)	
	Floor polish/wax (liquid)	
	Food packaging and packaged food	
	Furniture polish (liquid)	
	Furniture polish (aerosol)	
	General cleaner/disinfectant (liquid)	
	General cleaner (powder)	
	General cleaner/disinfectant (aerosol and pump)	
	General spot/stain remover (liquid)	
	General spot/stain remover (aerosol and pump)	
	Herbicide (garden-patio) (Liquid and aerosol)	
	Insecticide (home and garden) (powder)	
	Insecticide (home and garden) (aerosol and pump)	
	Insect repellent (liquid and aerosol)	
	Laundry detergent/bleach (liquid)	
	Laundry detergent (powder)	
	Laundry pre-wash/soak (powder)	
	Laundry pre-wash/soak (liquid)	
	Laundry pre-wash/soak (aerosol and pump)	
	Lubricant oil (liquid)	
	Lubricant (aerosol)	
	Matches	
	Metal polish	
	Oven cleaner (aerosol)	
	Pesticide (home) (solid)	
	Pesticide (pet dip) (liquid)	
	Pesticide (pet) (powder)	
	Pesticide (pet) (aerosol)	
	Pesticide (pet) (collar)	
	Petroleum fuels (home) (liquid and aerosol)	
	Rug cleaner/shampoo (liquid and aerosol)	
	Rug deodorizer/freshener (powder)	
	Room deodorizer (solid)	
	Room deodorizer (aerosol)	
	Scouring pad	
	Toilet bowl cleaner	
	Toilet bowl deodorant (solid)	
	Water-treating chemicals (swimming pools)	
	Home Building/Improvement Products (DIY) <sup>b</sup>	Adhesives, specialty (liquid)
		Ceiling tile
Caulks/sealers/fillers		
Dry wall/wall board		
Flooring (vinyl)		
House Paint (interior) (liquid)		
House Paint and Stain (exterior) (liquid)		
Insulation (solid)		
Insulation (foam)		



Table 16-1. Consumer Products Found in the Typical U.S. Household <sup>a</sup> (continued)	
Consumer Product Category	Consumer Product
Home Building/Improvement Products (DIY) <sup>b</sup> (Continued)	Paint/varnish removers Paint thinner/brush cleaners Patching/ceiling plaster Roofing Refinishing products (polyurethane, varnishes, etc.) Spray paints (home) (aerosol) Wall paneling Wall paper Wall paper glue
Automobile-related Products	Antifreeze Car polish/wax Fuel/lubricant additives Gasoline/diesel fuel Interior upholstery/components, synthetic Motor oil Radiator flush/cleaner Automotive touch-up paint (aerosol) Windshield washer solvents
Personal Materials	Clothes/shoes Diapers/vinyl pants Jewelry Printed material (colorprint, newsprint, photographs) Sheets/towels Toys (intended to be placed in mouths)
<sup>a</sup> A subjective listing based on consumer use profiles. <sup>b</sup> DIY = Do It Yourself. Source: U.S. EPA, 1987.	



Table 16-2. Frequency of Use for Household Solvent Products (users-only)

Products	Mean	Std. dev.	Min.	Percentile Rankings for Frequency of Use/Year									
				1	5	10	25	50	75	90	95	99	Max.
Spray Shoe Polish	10.28	20.10	1.00	1.00	1.00	1.00	2.00	4.00	8.00	24.30	52.00	111.26	156.00
Water Repellents/Protectors	3.50	11.70	1.00	1.00	1.00	1.00	1.00	2.00	3.00	6.00	10.00	35.70	300.00
Spot Removers	15.59	43.34	1.00	1.00	1.00	1.00	2.00	3.00	10.00	40.00	52.00	300.00	365.00
Solvent-Type Cleaning Fluids or Degreasers	16.46	44.12	1.00	1.00	1.00	1.00	2.00	4.00	12.00	46.00	52.00	300.00	365.00
Wood Floor and Paneling Cleaners	8.48	20.89	1.00	1.00	1.00	1.00	NA	2.00	6.00	24.00	50.00	56.00	350.00
TypeWriter Correction Fluid	40.00	74.78	1.00	1.00	1.00	2.00	4.00	12.00	40.00	100.00	200.00	365.00	520.00
Adhesives	8.89	26.20	1.00	1.00	1.00	1.00	2.00	3.00	6.00	15.00	28.00	100.00	500.00
Adhesive Removers	4.22	12.30	1.00	1.00	1.00	1.00	1.00	1.00	3.00	6.00	16.80	100.00	100.00
Silicone Lubricants	10.32	25.44	1.00	1.00	1.00	1.00	2.00	3.00	10.00	20.00	46.35	150.00	300.00
Other Lubricants (excluding Automotive)	10.66	25.46	1.00	1.00	1.00	1.00	2.00	4.00	10.00	20.00	50.00	100.00	420.00
Specialized Electronic Cleaners (for TVs, Etc.)	13.41	38.16	1.00	1.00	1.00	1.00	2.00	3.00	10.00	24.00	52.00	224.50	400.00
Latex Paint	3.93	20.81	1.00	1.00	1.00	1.00	1.00	2.00	4.00	6.00	10.00	30.00	800.00
Oil Paint	5.66	23.10	1.00	1.00	1.00	1.00	1.00	1.00	3.00	6.00	12.00	139.20	300.00
Wood Stains, Varnishes, and Finishes	4.21	12.19	1.00	1.00	1.00	1.00	1.00	2.00	4.00	7.00	12.00	50.80	250.00
Paint Removers/Strippers	3.68	9.10	1.00	1.00	1.00	1.00	4.00	2.00	3.00	6.00	11.80	44.56	100.00
Paint Thinners	6.78	22.10	0.03	0.03	0.10	0.23	1.00	2.00	4.00	12.00	23.00	100.00	352.00
Aerosol Spray Paint	4.22	15.59	1.00	1.00	1.00	1.00	1.00	2.00	4.00	6.10	12.00	31.05	365.00
Primers and Special Primers	3.43	8.76	1.00	1.00	1.00	1.00	1.00	1.00	3.00	6.00	10.00	50.06	104.00
Aerosol Rust Removers	6.17	9.82	1.00	1.00	1.00	1.00	1.00	2.00	6.00	15.00	24.45	50.90	80.00
Outdoor Water Repellents (for Wood or Cement)	2.07	3.71	1.00	1.00	1.00	1.00	1.00	2.00	2.00	3.00	5.90	12.00	52.00
Glass Frostings, Window Tints, and Artificial Snow	2.78	21.96	1.00	1.00	1.00	1.00	1.00	1.00	1.00	2.00	2.00	27.20	365.00
Engine Degreasers													
Carburetor Cleaners	4.18	13.72	1.00	1.00	1.00	1.00	1.00	2.00	3.25	6.70	12.00	41.70	300.00
Aerosol Spray Paints for Cars	3.77	7.10	1.00	1.00	1.00	1.00	1.00	2.00	3.00	6.00	12.00	47.28	100.00
Auto Spray Primers	4.50	9.71	1.00	1.00	1.00	1.00	1.00	2.00	4.00	10.00	15.00	60.00	100.00
Spray Lubricant for Cars	6.42	33.89	1.00	1.00	1.00	1.00	1.00	2.00	3.75	10.00	15.00	139.00	500.00
Transmission Cleaners	10.31	30.71	1.00	1.00	1.00	1.00	2.00	3.00	6.00	20.00	40.00	105.60	365.00
Battery Terminal Protectors	2.28	3.55	1.00	NA	1.00	1.00	1.00	1.00	2.00	3.00	9.00	NA	26.00
Brake Quieters Cleaners	3.95	24.33	1.00	1.00	1.00	1.00	1.00	2.00	2.00	4.00	6.55	41.30	365.00
Gasket Remover	3.00	6.06	1.00	NA	1.00	1.00	1.00	2.00	2.00	6.00	10.40	NA	52.00
Tire/Hubcap Cleaners	2.50	4.39	1.00	NA	1.00	1.00	1.00	1.00	2.00	5.00	6.50	NA	30.00
Ignition and Wire Dryers	11.18	18.67	1.00	1.00	1.00	1.00	2.00	4.00	12.00	30.00	50.00	77.00	200.00
	3.01	5.71	1.00	1.00	1.00	1.00	1.00	2.00	3.00	5.00	9.70	44.52	60.00

NA = Not Available  
Source: Westat, 1987a



Table 16-3. Exposure Time of Use for Household Solvent Products (users-only)

Products	Mean (mins)	Std. dev.	Percentile Rankings for Duration of Use (minutes)										
			Min.	1	5	10	25	50	75	90	95	99	Max.
Spray Shoe Polish	7.49	9.60	0.02	0.03	0.25	0.50	2.00	5.00	10.00	18.00	30.00	60.00	60.00
Water Repellents/Protectors	14.46	24.10	0.02	0.08	0.50	1.40	3.00	10.00	15.00	30.00	60.00	120.00	480.00
Spot Removers	10.68	22.36	0.02	0.03	0.08	0.25	2.00	5.00	10.00	30.00	30.00	120.00	360.00
Solvent-Type Cleaning Fluids or Degreasers	29.48	97.49	0.02	0.03	1.00	2.00	5.00	15.00	30.00	60.00	120.00	300.00	1800.00
Wood Floor and Paneling Cleaners	74.04	128.43	0.02	1.00	5.00	10.00	20.00	30.00	90.00	147.00	240.00	480.00	2700.00
TypeWriter Correction Fluid	7.62	29.66	0.02	0.02	0.03	0.03	0.17	1.00	2.00	10.00	32.00	120.00	480.00
Adhesives	15.58	81.80	0.02	0.03	0.08	0.33	1.00	4.25	10.00	30.00	60.00	180.00	2880.00
Adhesive Removers	121.20	171.63	0.03	0.03	1.45	3.00	15.00	60.00	120.00	246.00	480.00	960.00	960.00
Silicone Lubricants	10.42	29.47	0.02	0.03	0.08	0.17	0.50	2.00	10.00	20.00	45.00	180.00	360.00
Other Lubricants (excluding Automotive)	8.12	32.20	0.02	0.03	0.05	0.08	0.50	2.00	5.00	15.00	30.00	90.00	900.00
Specialized Electronic Cleaners (for TVs, Etc.)	9.47	45.35	0.02	0.03	0.08	0.17	0.50	2.00	5.00	20.00	30.00	93.60	900.00
Latex Paint	295.08	476.11	0.02	1.00	22.50	30.00	90.00	180.00	360.00	480.00	810.00	2880.00	5760.00
Oil Paint	194.12	345.68	0.02	0.51	15.00	30.00	60.00	12.00	240.00	480.00	579.00	1702.80	5760.00
Wood Stains, Varnishes, and Finishes	117.17	193.05	0.02	0.74	5.00	10.00	30.00	60.00	120.00	140.00	360.00	720.00	280.00
Paint Removers/Strippers	125.27	286.59	0.02	0.38	5.00	5.00	20.00	60.00	120.00	240.00	420.00	1200.00	4320.00
Paint Thinners	39.43	114.85	0.02	0.08	1.00	2.00	5.00	10.00	30.00	60.00	180.00	480.00	2400.00
Aerosol Spray Paint	39.54	87.79	0.02	0.17	2.00	5.00	10.00	20.00	45.00	60.00	120.00	300.00	1800.00
Primers and Special Primers	91.29	175.05	0.05	0.24	3.00	5.00	15.00	30.00	120.00	240.00	360.00	981.60	1920.00
Aerosol Rust Removers	18.57	48.54	0.02	0.05	0.17	0.25	2.00	5.00	20.00	60.00	60.00	130.20	720.00
Outdoor Water Repellents (for Wood or Cement)	104.94	115.36	0.02	0.05	5.00	15.00	30.00	60.00	120.00	240.00	300.00	480.00	960.00
Glass Frostings, Window Tints, and Artificial Snow	29.45	48.16	0.03	0.14	2.00	3.00	5.00	15.00	30.00	60.00	96.00	268.80	360.00
Engine Degreasers, Carburetor Cleaners	29.29	48.14	0.02	0.95	2.00	5.00	10.00	15.00	30.00	60.00	120.00	180.00	900.00
Aerosol Spray Paints for Cars	13.57	23.00	0.02	0.08	0.33	1.00	3.00	7.00	15.00	30.00	45.00	120.00	300.00
Auto Spray Primers	42.77	71.39	0.03	0.19	1.00	3.00	10.00	20.00	60.00	120.00	145.00	360.00	900.00
Spray Lubricant for Cars	51.45	86.11	0.05	0.22	2.00	5.00	10.00	27.50	60.00	120.00	180.00	529.20	600.00
Transmission Cleaners	9.90	35.62	0.02	0.03	0.08	0.17	1.00	5.00	10.00	15.00	30.00	120.00	720.00
Battery Terminal Protectors	27.90	61.44	0.17	NA	0.35	1.80	5.00	15.00	30.00	60.00	60.00	NA	450.00
Brake Quieters/Cleaners	9.61	18.15	0.03	0.04	0.08	0.23	1.00	5.00	10.00	20.00	30.00	120.00	180.00
Gasket Remover	23.38	36.32	0.07	NA	0.50	1.00	5.00	15.00	30.00	49.50	120.00	NA	240.00
Tire/Hubcap Cleaners	23.57	27.18	0.33	NA	0.50	2.00	6.25	15.00	30.00	60.00	60.00	NA	180.00
Ignition and Wire Drivers	22.66	23.94	0.08	0.71	3.00	5.00	10.00	15.00	30.00	60.00	60.00	120.00	240.00
	7.24	8.48	0.02	0.02	0.08	0.47	1.50	5.00	10.00	15.00	25.50	48.60	60.00

NA = Not Available  
Source: Westat, 1987a



Table 16-4. Amount of Products Used for Household Solvent Products (users-only)

Products	Mean (ounces/yr)	Std. dev	Min.	Percentile Rankings for Amount of Products Used (ounces/yr)									
				1	5	10	25	50	75	90	95	99	Max.
Spray Shoe Polish	9.90	17.90	0.04	0.20	0.63	1.00	2.00	4.50	10.00	24.00	36.00	99.36	180.00
Water Repellents/Protectors	11.38	22.00	0.04	0.47	0.98	1.43	2.75	6.00	12.00	24.00	33.00	121.84	450.00
Spot Removers	26.32	90.10	0.01	0.24	0.60	1.00	2.00	5.50	16.00	48.00	119.20	384.00	1600.00
Solvent-Type Cleaning Fluids or Degreasers	58.30	226.97	0.04	0.50	2.00	3.00	6.50	16.00	32.00	96.00	192.00	845.00	5120.00
Wood Floor and Paneling Cleaners	28.41	57.23	0.03	0.80	2.45	3.50	7.00	14.00	30.00	64.00	96.00	204.40	1144.00
TypeWriter Correction Fluid	4.14	13.72	0.01	0.02	0.06	0.12	0.30	0.94	2.40	8.00	18.00	67.44	181.80
Adhesives	7.49	55.90	0.01	0.02	0.05	0.12	0.35	1.00	3.00	8.00	20.00	128.00	1280.00
Adhesive Removers	34.46	96.60	0.25	0.29	1.22	2.80	6.00	10.88	32.00	64.00	138.70	665.60	1024.00
Silicone Lubricants	12.50	27.85	0.02	0.20	0.69	1.00	2.25	4.50	12.00	24.00	41.20	192.00	312.00
Other Lubricants (excluding Automotive)	9.93	44.18	0.01	0.18	0.30	0.52	1.00	2.25	8.00	18.00	32.00	128.00	1280.00
Specialized Electronic Cleaners (for TVs, Etc.)	9.48	55.26	0.01	0.05	0.13	0.25	0.52	2.00	6.00	12.65	24.00	109.84	1024.00
Latex Paint	371.27	543.86	0.03	4.00	12.92	32.00	64.00	256.00	384.00	857.60	1280.00	2560.00	6400.00
Oil Paint	168.92	367.82	0.02	0.33	4.00	8.00	25.20	64.00	148.48	384.00	640.00	1532.16	5120.00
Wood Stains, Varnishes, and Finishes	65.06	174.01	0.12	1.09	4.00	4.00	8.00	16.00	64.00	128.00	256.00	768.00	3840.00
Paint Removers/Strippers	63.73	144.33	0.64	1.50	4.00	8.00	16.00	32.00	64.00	128.00	256.00	512.00	2560.00
Paint Thinners	69.45	190.55	0.03	0.45	3.10	4.00	8.00	20.48	64.00	128.00	256.00	640.00	3200.00
Aerosol Spray Paint	30.75	52.84	0.02	0.75	2.01	3.25	7.00	13.00	32.00	65.00	104.00	240.00	1053.00
Primers and Special Primers	68.39	171.21	0.01	0.09	1.30	3.23	8.00	16.00	60.00	128.00	256.00	867.75	1920.00
Aerosol Rust Removers	18.21	81.37	0.09	0.25	1.00	1.43	2.75	8.00	13.00	32.00	42.60	199.80	1280.00
Outdoor Water Repellents (for Wood or Cement)	148.71	280.65	0.01	0.37	3.63	8.00	16.00	64.00	128.00	448.00	640.00	979.20	3200.00
Glass Frostings, Window Tints, and Artificial Snow	13.82	14.91	1.00	1.40	2.38	3.25	6.00	12.00	14.00	28.00	33.00	98.40	120.00
Engine Degreasers	46.95	135.17	0.04	1.56	4.00	6.00	12.00	16.00	36.00	80.00	160.00	480.00	2560.00
Carburetor Cleaners	22.00	50.60	0.10	0.50	1.50	3.00	5.22	12.00	16.00	39.00	75.00	212.00	672.00
Aerosol Spray Paints for Cars	44.95	89.78	0.04	0.14	1.50	3.00	6.12	16.00	48.00	100.80	156.00	557.76	900.00
Auto Spray Primers	70.37	274.56	0.12	0.77	3.00	4.00	9.00	16.00	48.00	128.00	222.00	1167.36	3840.00
Spray Lubricant for Cars	18.63	54.74	0.08	0.40	0.96	1.00	2.75	6.00	15.50	36.00	64.00	240.00	864.00
Transmission Cleaners	35.71	62.93	2.00	NA	3.75	4.00	8.00	15.00	32.00	77.00	140.00	NA	360.00
Battery Terminal Protectors	16.49	87.84	0.12	0.13	0.58	1.00	2.00	4.00	8.00	15.00	24.60	627.00	1050.00
Brake Quieters/Cleaners	11.72	13.25	0.50	NA	1.00	2.00	3.02	8.00	14.25	32.00	38.60	NA	78.00
Gasket Remover	13.25	22.35	0.50	NA	1.00	1.00	3.75	7.75	16.00	24.00	58.40	NA	160.00
Tire/Hubcap Cleaners	31.58	80.39	0.12	0.50	1.82	3.00	6.00	12.00	28.00	64.00	96.00	443.52	960.00
Ignition and Wire Drivers	9.02	14.59	0.13	0.32	1.09	1.50	3.00	6.00	10.75	16.00	20.55	113.04	120.00

NA = Not Available  
Source: Westat, 1987a



Table 16-5. Time Exposed After Duration of Use for Household Solvent Products (users-only)

Products	Mean (mins)	Std. dev.	Min.	Percentile Rankings for Time Exposed After Duration of Use (minutes)									
				1	5	10	25	50	75	90	95	99	Max.
Spray Shoe Polish	31.40	80.50	0.00	0.00	0.00	0.00	0.00	5.00	20.00	120.00	120.00	480.00	720.00
Water Repellents/Protectors	37.95	111.40	0.00	0.00	0.00	0.00	0.00	3.00	20.00	120.00	240.00	480.00	1800.00
Spot Removers	43.65	106.97	0.00	0.00	0.00	0.00	1.00	5.00	30.00	120.00	240.00	480.00	1440.00
Solvent-Type Cleaning Fluids or Degreasers	33.29	90.39	0.00	0.00	0.00	0.00	0.00	3.00	28.75	60.00	180.00	480.00	1440.00
Wood Floor and Paneling Cleaners	96.75	192.88	0.00	0.00	0.00	0.00	5.00	30.00	120.00	240.00	480.00	1062.00	1440.00
TypeWriter Correction Fluid	124.70	153.46	0.00	0.00	1.00	5.00	30.00	60.00	180.00	360.00	480.00	600.00	1800.00
Adhesives	68.88	163.72	0.00	0.00	0.00	0.00	1.00	10.00	60.00	180.00	360.00	720.00	2100.00
Adhesive Removers	94.12	157.69	0.00	0.00	0.00	0.00	1.75	20.00	120.00	360.00	480.00	720.00	720.00
Silicone Lubricants	30.77	107.39	0.00	0.00	0.00	0.00	0.00	0.00	10.00	60.00	180.00	480.00	1440.00
Other Lubricants (excluding Automotive)	47.45	127.11	0.00	0.00	0.00	0.00	0.00	2.00	30.00	120.00	240.00	485.40	1440.00
Specialized Electronic Cleaners (for TVs, Etc.)	117.24	154.38	0.00	0.00	0.00	1.00	10.00	60.00	180.00	300.00	480.00	720.00	1440.00
Latex Paint	91.38	254.61	0.00	0.00	0.00	0.00	0.00	5.00	60.00	240.00	480.00	1440.00	2880.00
Oil Paint	44.56	155.19	0.00	0.00	0.00	0.00	0.00	0.00	30.00	120.00	240.00	480.00	2880.00
Wood Stains, Varnishes, and Finishes	48.33	156.44	0.00	0.00	0.00	0.00	0.00	1.00	30.00	120.00	240.00	694.00	2880.00
Paint Removers/Strippers	31.38	103.07	0.00	0.00	0.00	0.00	0.00	0.00	20.00	60.00	180.00	541.20	1440.00
Paint Thinners	32.86	105.62	0.00	0.00	0.00	0.00	0.00	0.00	15.00	60.00	180.00	480.00	1440.00
Aerosol Spray Paint	12.70	62.80	0.00	0.00	0.00	0.00	0.00	0.00	1.00	30.00	60.00	260.50	1440.00
Primers and Special Primers	22.28	65.57	0.00	0.00	0.00	0.00	0.00	0.00	10.00	60.00	120.00	319.20	720.00
Aerosol Rust Removers	15.06	47.58	0.00	0.00	0.00	0.00	0.00	0.00	5.00	60.00	60.00	190.20	600.00
Outdoor Water Repellents (for Wood or Cement)	8.33	43.25	0.00	0.00	0.00	0.00	0.00	0.00	0.00	5.00	58.50	309.60	420.00
Glass Frostings, Window Tints, and Artificial Snow	137.87	243.21	0.00	0.00	0.00	0.00	3.00	60.00	180.00	360.00	480.00	1440.00	1800.00
Engine Degreasers	4.52	24.39	0.00	0.00	0.00	0.00	0.00	0.00	0.00	0.00	15.50	120.00	360.00
Carburetor Cleaners	7.51	68.50	0.00	0.00	0.00	0.00	0.00	0.00	0.00	0.10	30.00	120.60	1800.00
Aerosol Spray Paints for Cars	10.71	45.53	0.00	0.00	0.00	0.00	0.00	0.00	0.00	17.50	60.00	282.00	480.00
Auto Spray Primers	11.37	45.08	0.00	0.00	0.00	0.00	0.00	0.00	0.00	20.00	77.25	360.00	360.00
Spray Lubricant for Cars	4.54	30.67	0.00	0.00	0.00	0.00	0.00	0.00	0.00	2.00	15.00	70.20	420.00
Transmission Cleaners	5.29	29.50	0.00	NA	0.00	0.00	0.00	0.00	0.00	5.00	22.50	NA	240.00
Battery Terminal Protectors	3.25	17.27	0.00	NA	0.00	0.00	0.00	0.00	0.00	2.90	15.00	120.00	180.00
Brake Quieters/Cleaners	10.27	30.02	0.00	NA	0.00	0.00	0.00	0.00	0.00	30.00	120.00	NA	120.00
Gasket Remover	27.56	58.54	0.00	NA	0.00	0.00	0.00	0.00	12.50	120.00	180.00	NA	240.00
Tire/Hubcap Cleaners	1.51	20.43	0.00	0.00	0.00	0.00	0.00	0.00	0.00	0.00	0.00	30.00	480.00
Ignition and Wire Drivers	6.39	31.63	0.00	0.00	0.00	0.00	0.00	0.00	0.00	0.10	30.00	216.60	240.00

NA = Not Available  
Source: Westat, 1987a





Table 16-6. Frequency of Use and Amount of Product Used for Adhesive Removers						
	No. of Times Used Within the Last 12 Months N=58	Minutes Using N=52	Minutes in Room After Using <sup>a</sup> N=51	Minutes in Room After Using <sup>b</sup> N=5	Amount Used in Past Year (Fluid oz.) N=51	Amount per Use (Fluid oz.) N=51
Mean	1.66	172.87	13.79	143.37	96.95	81.84
Standard deviation	1.67	304.50	67.40	169.31	213.20	210.44
Minimum Value	1.00	5.00	0.00	5.00	13.00	5.20
1st Percentile	1.00	5.00	0.00	5.00	13.00	5.20
5th Percentile	1.00	10.00	0.00	5.00	13.00	6.50
10th Percentile	1.00	15.00	0.00	5.00	16.00	10.67
25th Percentile	1.00	29.50	0.00	20.00	16.00	16.00
Median Value	1.00	120.00	0.00	120.00	32.00	26.00
75th Percentile	2.00	240.00	0.00	420.00	96.00	64.00
90th Percentile	3.00	480.00	0.00	420.00	128.00	128.00
95th Percentile	5.00	1440.00	120.00	420.00	384.00	192.00
99th Percentile	12.00	1440.00	420.00	420.00	1280.00	1280.00
Maximum Value	12.00	1440.00	420.00	1440.00	1280.00	1280.00

<sup>a</sup> Includes those who did not spend anytime in the room after use.  
<sup>b</sup> Includes only those who spent time in the room.  
Source: Abt, 1992.

Table 16-7. Adhesive Remover Usage by Gender		
	Gender	
	Male N=25	Female N=33
Mean number of months since last time adhesive remover was used - includes <u>all</u> respondents. (Unweighted N=240)	35.33	43.89
Mean number of uses of product in the past year.	1.94	1.30
Mean number of minutes spent with the product during last use.	127.95	233.43
Mean number of minutes spent in the room after last use of product. (Includes all recent users)	19.76	0
Mean number of minutes spent in the room after last use of product. (Includes only those who did not leave immediately)	143.37	0
Mean ounces of product used in the past year.	70.48	139.71
Mean ounces of product used per use in the past year.	48.70	130.36

Source: Abt, 1992.



Table 16-8. Frequency of Use and Amount of Product Used for Spray Paint

	No. of Times Used Within the Last 12 Months N=775	Minutes Using N=786	Minutes in Room After Using <sup>a</sup> N=791	Minutes in Room After Using <sup>b</sup> N=35	Amount Used in Past Year (Fluid oz.) N=778	Amount per Use (Fluid oz.) N=778
Mean	8.23	40.87	3.55	65.06	83.92	19.04
Standard deviation	31.98	71.71	22.03	70.02	175.32	25.34
Minimum Value	1.00	1.00	0.00	1.00	13.00	0.36
1st Percentile	1.00	1.00	0.00	1.00	13.00	0.36
5th Percentile	1.00	3.00	0.00	1.00	13.00	3.47
10th Percentile	1.00	5.00	0.00	10.00	13.00	6.50
25th Percentile	1.00	10.00	0.00	15.00	13.00	9.75
Median Value	2.00	20.00	0.00	30.00	26.00	13.00
75th Percentile	4.00	45.00	0.00	60.00	65.00	21.67
90th Percentile	11.00	90.00	0.00	120.00	156.00	36.11
95th Percentile	20.00	120.00	0.00	120.00	260.00	52.00
99th Percentile	104.00	360.00	120.00	300.00	1170.00	104.00
Maximum Value	365.00	960.00	300.00	300.00	1664.00	312.00

<sup>a</sup> Includes those who did not spend anytime in the room after use.  
<sup>b</sup> Includes only those who spent time in the room.  
 Source: Abt, 1992.

Table 16-9. Spray Paint Usage by Gender

	Gender	
	Male N=405	Female N=386
Mean number of months since last time spray paint was used - includes <u>all</u> respondents. (Unweighted N=1724)	17.39	26.46
Mean number of uses of product in the past year.	10.45	4.63
Mean number of minutes spent with the product during last use.	40.87	40.88
Mean number of minutes spent in the room after last use of product. (Includes all recent users)	5.49	0.40
Mean number of minutes spent in the room after last use of product. (Includes only those who did not leave immediately)	67.76	34.69
Mean ounces of product used in the past year.	103.07	59.99
Mean ounces of product used per use in the past year.	18.50	19.92

Source: Abt, 1992.



Table 16-10. Frequency of Use and Amount of Product Used for Paint Removers/Strippers

	No. of Times Used Within the Last 12 Months N=316	Minutes Using N=390	Minutes in Room After Using <sup>a</sup> N=390	Minutes in Room After Using <sup>b</sup> N=39	Amount Used in Past Year (Fluid oz.) N=307	Amount per Use (Fluid oz.) N=307
Mean	3.54	144.59	12.96	93.88	142.05	64.84
Standard deviation	7.32	175.54	85.07	211.71	321.73	157.50
Minimum Value	1.00	2.00	0.00	1.00	15.00	0.35
1st Percentile	1.00	5.00	0.00	1.00	15.00	2.67
5th Percentile	1.00	15.00	0.00	1.00	16.00	8.00
10th Percentile	1.00	20.00	0.00	3.00	16.00	10.67
25th Percentile	1.00	45.00	0.00	10.00	32.00	16.00
Median Value	2.00	120.00	0.00	60.00	64.00	32.00
75th Percentile	3.00	180.00	0.00	120.00	128.00	64.00
90th Percentile	6.00	360.00	10.00	180.00	256.00	128.00
95th Percentile	12.00	480.00	60.00	420.00	384.00	192.00
99th Percentile	50.00	720.00	180.00	1440.00	1920.00	320.00
Maximum Value	70.00	1440.00	1440.00	1440.00	3200.00	2560.00

<sup>a</sup> Includes those who did not spend anytime in the room after use.  
<sup>b</sup> Includes only those who spent time in the room.  
 Source: Abt, 1992.

Table 16-11. Paint Stripper Usage by Gender

	Gender	
	Male N=156	Female N=162
Mean number of months since last time paint stripper was used - includes <u>all</u> respondents. (Unweighted N=1724)	32.07	47.63
Mean number of uses of product in the past year.	3.88	3.01
Mean number of minutes spent with the product during last use.	136.70	156.85
Mean number of minutes spent in the room after last use of product. (Includes all recent users)	15.07	9.80
Mean number of minutes spent in the room after last use of product. (Includes only those who did not leave immediately)	101.42	80.15
Mean ounces of product used in the past year.	160.27	114.05
Mean ounces of product used per use in the past year.	74.32	50.29

Source: Abt, 1992.



Table 16-12. Total Exposure Time of Performing Task and Product Type Used by Task for Household Cleaning Products				
Tasks	Mean (hrs/year)	Median (hrs/year)	Product Type Used	Percent of Preference
Clean Bathroom Sinks and Tubs	44	26	Liquid	29%
			Powder	44%
			Aerosol	16%
			Spray pump	10%
			Other	1%
Clean Kitchen Sinks	41	18	Liquid	31%
			Powder	61%
			Aerosol	2%
			Spray pump	4%
			Other	2%
Clean Inside of Cabinets (such as kitchen)	12	5	Liquid	68%
			Powder	12%
			Aerosol	2%
			Spray pump	16%
			Other	2%
Clean Outside of Cabinets	21	6	Liquid	61%
			Powder	8%
			Aerosol	16%
			Spray pump	13%
			Other	2%
Wipe Off Kitchen Counters	92	55	Liquid	67%
			Powder	13%
			Aerosol	2%
			Spray pump	15%
			Other	3%
Thoroughly Clean Counters	24	13	Liquid	56%
			Powder	21%
			Aerosol	5%
			Spray pump	17%
			Other	1%
Clean Bathroom Floors	20	9	Liquid	70%
			Powder	21%
			Aerosol	2%
			Spray pump	4%
			Other	3%
Clean Kitchen Floors	31	14	Liquid	70%
			Powder	27%
			Aerosol	2%
			Spray pump	1%
			Other	--
Clean Bathroom or Other Tilted or Ceramic Walls	16	9	Liquid	37%
			Powder	18%
			Aerosol	17%
			Spray pump	25%
			Other	3%



Table 16-12. Total Exposure Time of Performing Task and Product Type Used by Task for Household Cleaning Products (continued)

Tasks	Mean (hrs/year)	Median (hrs/year)	Product Type Used	Percent of Preference
Clean Outside of Windows	13	6	Liquid	27%
			Powder	2%
			Aerosol	6%
			Spray pump	65%
			Other	--
Clean Inside of Windows	18	6	Liquid	24%
			Powder	1%
			Aerosol	8%
			Spray pump	66%
			Other	2%
Clean Glass Surfaces Such as Mirrors & Tables	34	13	Liquid	13%
			Powder	1%
			Aerosol	8%
			Spray pump	76%
			Other	2%
Clean Outside of Refrigerator and Other Appliances	27	13	Liquid	48%
			Powder	3%
			Aerosol	7%
			Spray pump	38%
			Other	4%
Clean Spots or Dirt on Walls or Doors Finishes	19	8	Liquid	46%
			Powder	15%
			Aerosol	4%
			Spray pump	30%
			Other	4%

Source: Westat, 1987b.



Table 16-13. Percentile Rankings for Total Exposure Time in Performing Household Tasks

Tasks	Percentile Rankings for Total Exposure Exposure Time Performing Task (hrs/yr)							
	100th	95th	90th	75th	50th	25th	10th	0th
Clean Bathroom Sinks and Tubs	365	121.67	91.25	52	26	13	5.2	0.4
Clean Kitchen Sinks	547.5	121.67	97.6	60.83	18.25	8.67	3.47	0.33
Clean Inside of Kitchen Cabinets	208	48	32.48	12	4.75	2	1	0.17
Clean Outside of Cabinets	780	78.66	36	17.33	6	2	0.967	0.07
Wipe Off Kitchen Counters	912.5	456.25	231.16	91.25	54.75	24.33	12.17	1.2
Thoroughly Clean Counters	547.5	94.43	52	26	13	6	1.75	0.17
Clean Bathroom Floors	365	71.49	36.83	26	8.67	4.33	2	0.1
Clean Kitchen Floors	730	96.98	52	26	14	8.67	4.33	0.5
Clean Bathroom or Other Tilted or Ceramic Walls	208	52	36	26	8.67	3	1	0.17
Clean Outside of Windows	468	32.6	24	11.5	6	2	1.5	0.07
Clean Inside of Windows	273	72	36	19.5	6	3	1.15	0.07
Clean Glass Surfaces Such as Mirrors & Tables	1460	104	60.83	26	13	6	1.73	0.17
Clean Outside Refrigerator and Other Appliances	365	95.29	91.25	30.42	13	4.33	1.81	0.1
Clean Spots or Dirt on Walls or Doors	312	78	52	24	8	2	0.568	0.07

Source: Westat, 1987b.



Table 16-14. Mean Percentile Rankings for Frequency of Performing Household Tasks

Tasks	Mean	Percentile Rankings							
		0th	10th	25th	50th	75th	90th	95th	100th
Clean bathroom sinks and tubs	3 x/week	0.2 x/week	1 x/week	1 x/week	2 x/week	3.5 x/week	7 x/week	7 x/week	42 x/week
Clean kitchen sinks	7 x/week	0 x/week	1 x/week	2 x/week	7 x/week	7 x/week	15 x/week	21 x/week	28 x/week
Clean inside of cabinets such as those in the kitchen	9 x/year	1 x/year	1 x/year	1 x/year	2 x/year	12 x/year	12 x/year	52 x/year	156 x/year
Clean outside of cabinets	3 x/month	0.1 x/month	0.1 x/month	0.3 x/month	1 x/month	4 x/month	4 x/month	22 x/month	30 x/month
Wipe off counters such as those in the kitchen	2 x/day	0 x/day	0.4 x/day	1 x/day	1 x/day	3 x/day	4 x/day	6 x/day	16 x/day
Thoroughly clean counters	8 x/month	0.1 x/month	0.8 x/month	1 x/month	4 x/month	4 x/month	30 x/month	30 x/month	183 x/month
Clean bathroom floors	6 x/month	0.2 x/month	1 x/month	2 x/month	4 x/month	4 x/month	13 x/month	30 x/month	30 x/month
Clean kitchen floors	6 x/month	0.1 x/month	1 x/month	2 x/month	4 x/month	4 x/month	13 x/month	30 x/month	30 x/month
Clean bathroom or other tiled or ceramic walls	4 x/month	0.1 x/month	0.2 x/month	1 x/month	2 x/month	4 x/month	9 x/month	13 x/month	30 x/month
Clean outside of windows	5 x/year	1 x/year	1 x/year	1 x/year	2 x/year	4 x/year	12 x/year	12 x/year	156 x/year
Clean inside of windows	10 x/year	1 x/year	1 x/year	2 x/year	4 x/year	12 x/year	24 x/year	52 x/year	156 x/year
Clean other glass surfaces such as mirrors and tables	7 x/month	0.1 x/month	1 x/month	2 x/month	4 x/month	4 x/month	17 x/month	30 x/month	61 x/month
Clean outside of refrigerator and other appliances	10 x/month	0.2 x/month	1 x/month	2 x/month	4 x/month	13 x/month	30 x/month	30 x/month	61 x/month
Clean spots or dirt on walls or doors	6 x/month	0.1 x/month	0.2 x/month	0.3 x/month	1 x/month	4 x/month	13 x/month	30 x/month	152 x/month

Source: Westat, 1987b.



16-15. Mean and Percentile Rankings for Exposure Time Per Event of Performing Household Tasks									
Tasks	Mean (minutes/event)	Percentile Rankings (minutes/event)							
		0th	10th	25th	50th	75th	90th	95th	100th
Clean bathroom sinks and tubs	20	1	5	10	15	30	45	60	90
Clean kitchen sinks	10	1	2	3	5	10	15	20	480
Clean inside of cabinets such as those in the kitchen	137	5	24	44	120	180	240	360	2,880
Clean outside of cabinets	52	1	5	15	30	60	120	180	330
Wipe off counters such as those in the kitchen	9	1	2	3	5	10	15	30	120
Thoroughly clean counters	25	1	5	10	15	30	60	90	180
Clean bathroom floors	16	1	5	10	15	20	30	38	60
Clean kitchen floors	30	2	10	15	20	30	60	60	180
Clean bathroom or other tiled or ceramic walls	34	1	5	15	30	45	60	120	240
Clean outside of windows	180	4	30	60	120	240	420	480	1,200
Clean inside of windows	127	4	20	45	90	158	300	381	1,200
Clean other glass surfaces such as mirrors and tables	24	1	5	10	15	30	60	60	180
Clean outside of refrigerator and other appliances	19	1	4	5	10	20	30	45	240
Clean spots or dirt on walls or doors	50	1	5	10	20	60	120	216	960

Source: Westat, 1987b.

Table 16-16. Total Exposure Time for Ten Product Groups Most Frequently Used for Household Cleaning <sup>a</sup>									
Products	Mean (hrs/yr)	Percentile Rankings of Total Exposure Time (hrs/yr)							
		0th	10th	25th	50th	75th	90th	95th	100th
Dish Detergents	107	0.2	6	24	56	134	274	486	941
Glass Cleaners	67	0.4	3	12	29	62	139	260	1,508
Floor Cleaners	52	0.7	4	7	22	52	102	414	449
Furniture Polish	32	0.1	0.3	1	12	36	101	215	243
Bathroom Tile Cleaners	47	0.5	2	8	17	48	115	287	369
Liquid Cleansers	68	0.2	2	9	22	52	122	215	2,381
Scouring Powders	78	0.3	9	17	35	92	165	281	747
Laundry Detergents	66	0.6	8	14	48	103	174	202	202
Rug Cleaners/Shampoos	12	0.3	0.3	0.3	9	26	26	26	26
All Purpose Cleaners	64	0.3	4	9	26	77	174	262	677

<sup>a</sup> The data in Table 16-15 above reflect for only the 14 tasks included in the survey. Therefore, many of the durations reported in the table underestimate the hours of the use of the product group. For example, use of dish detergents to wash dishes is not included.

Source: Westat, 1987b.





Table 16-17. Total Exposure Time of Painting Activity of Interior Painters (hours)

Types of Paint	Mean (hrs)	Std. dev.	Percentile Rankings for Duration of Painting Activity (hrs)							
			Min.	10	25	50	75	90	95	Max.
Latex	12.2	11.28	1	3	4	9	15	24	40	248
Oil-based	10.68	15.56	1	1.6	3	6	10	21.6	65.6	72
Wood Stains and Varnishes	8.57	10.85	1	1	2	4	9.3	24	40	42

Source: Westat, 1987c.

Table 16-18. Exposure Time of Interior Painting Activity/Occasion (hours) and Frequency of Occasions Spent Painting Per Year

Types of Paint	Duration of Painting/Occasion (hrs)		Frequency of Occasions Spent Painting/Year		Percentile Rankings for Frequency of Occasions Spent Painting							
	Mean	Median	Mean	Std. dev.	Min	10	25	50	75	90	95	Max.
Latex	2.97	3	4.16	5.54	1	1	2	3	4	9	10	62
Oil-based	2.14	3	5.06	11.98	1	1	1	2	4	8	26	72
Wood Stains and Varnishes	2.15	2	4.02	4.89	1	1	1	2	4	9	20	20

Source: Westat, 1987c.

Table 16-19. Amount of Paint Used by Interior Painters

Types of Paint	Median (gallons)	Mean (gallons)	Std. dev.	Percentile Rankings for Amount of Paint Used (gallons)							
				Min	10	25	50	75	90	95	Max.
Latex	3.0	3.89	4.56	0.13	1	2	3	5	8	10	50
Oil-based	2.0	2.55	3.03	0.13	0.25	0.5	2	3	7	12	12
Wood Stains and Varnishes	0.75	0.88	0.81	0.13	0.14	0.25	0.75	1	2	2	4.25

Source: Westat, 1987c.



Table 16-20. Number of Respondents Using Cologne, Perfume, Aftershave or Other Fragrances at Specified Daily Frequencies						
Population Group	Total N	Number of Times Used in a Day				
		1-2	3-5	6-9	10+	DK
<b>Overall</b>	2223	2100	113	4	2	4
<b>Gender</b>						
Male	912	868	44	*	*	*
Female	1311	1232	69	4	2	4
<b>Age (Years)</b>						
*	33	31	1	1	*	*
5-11	26	24	2	*	*	*
12-17	144	133	9	*	1	1
18-64	1735	1635	93	3	1	3
> 64	285	277	8	*	*	*
<b>Race</b>						
White	1781	1684	91	4	*	2
Black	242	233	7	*	1	1
Asian	30	30	*	*	*	*
Some Others	38	35	3	*	*	*
Hispanic	111	98	11	*	1	1
Refused	21	20	1	*	*	*
<b>Hispanic</b>						
No	2012	1909	95	4	1	3
Yes	182	165	15	*	1	1
DK	11	9	2	*	*	*
Refused	18	17	1	*	*	*
<b>Employment</b>						
*	157	145	10	*	1	1
Full Time	1195	1125	67	2	*	1
Part Time	240	228	11	*	1	*
Not Employed	618	591	23	2	*	2
Refused	13	11	2	*	*	*
<b>Education</b>						
*	208	194	12	*	1	1
< High School	190	177	13	*	*	*
High School Graduate	739	704	32	2	*	1
< College	504	480	21	*	1	2
College Graduate	331	308	21	2	*	*
Post Graduate	251	237	14	*	*	*
<b>Census Region</b>						
Northeast	459	434	21	3	*	1
Midwest	530	502	25	1	*	2
South	813	766	46	*	1	*
West	421	398	21	*	1	1
<b>Day of Week</b>						
Weekday	1480	1402	71	3	*	4
Weekend	743	698	42	1	2	*
<b>Season</b>						
Winter	604	574	26	1	1	2
Spring	588	549	36	1	1	1
Summer	568	535	31	2	*	*
Fall	463	442	20	*	*	1
<b>Asthma</b>						
No	2075	1959	106	4	2	4
Yes	143	136	7	*	*	*
DK	5	5	*	*	*	*
<b>Angina</b>						
No	2161	2043	108	4	2	4
Yes	52	47	5	*	*	*
DK	10	10	*	*	*	*
<b>Bronchitis/emphysema</b>						
No	2112	1994	108	4	2	4
Yes	103	98	5	*	*	*
DK	8	8	*	*	*	*

Note: \* = Missing Data; DK = Don't Know; Refused = Respondents Refused to Answer; N = Number of Respondents.  
 Source: Tsang and Klepeis, 1996.



Table 16-21. Number of Respondents Using Any Aerosol Spray Product for Personal Care Item Such as Deodorant or Hair Spray at Specified Daily Frequencies

Population Group	Total N	Number of Times Used in a Day									
		1	2	3	4	5	6	7	10	10+	DK
<b>Overall</b>	1491	1019	352	57	22	17	2	1	3	10	8
<b>Gender</b>											
Male	528	375	125	14	4	3	2	0	2	3	
Female	962	644	226	43	18	14	0	1	3	5	
Refused	1	0	1	0	0	0	0	0	0	0	
<b>Age (years)</b>											
0	27	14	8	1	2	1	0	0	0	1	
1-4	40	30	9	0	0	1	0	0	0	0	
5-11	75	57	14	1	1	1	1	0	0	0	
12-17	103	53	31	12	4	1	0	0	1	0	
18-64	1071	724	263	39	15	13	1	1	2	5	
> 64	175	141	27	4	0	0	0	0	0	2	
<b>Race</b>											
White	1232	855	285	47	17	8	2	0	3	5	
Black	131	84	32	5	3	5	0	0	0	2	
Asian	24	18	5	0	0	0	0	0	0	1	
Some Others	22	12	8	1	0	0	0	1	0	0	
Hispanic	73	45	19	4	1	4	0	0	0	0	
Refused	9	5	3	0	1	0	0	0	0	0	
<b>Hispanic</b>											
No	1359	937	316	49	20	13	2	1	3	8	
Yes	119	74	32	7	2	4	0	0	0	0	
DK	6	3	2	1	0	0	0	0	0	0	
Refused	7	5	2	0	0	0	0	0	0	0	
<b>Employment</b>											
0	210	137	52	11	4	3	1	0	1	0	
Full Time	714	492	171	24	11	5	1	1	1	4	
Part Time	152	99	35	7	0	5	0	0	0	2	
Not Employed	404	284	92	14	6	4	0	0	1	2	
Refused	11	7	2	1	1	0	0	0	0	0	
<b>Education</b>											
0	240	151	61	14	6	4	1	0	1	0	
< High School	128	83	37	2	1	1	0	0	0	2	
High School Graduate	528	365	121	23	7	5	1	0	2	3	
< College	311	212	77	7	3	6	0	1	0	1	
College Graduate	161	115	34	8	1	1	0	0	0	1	
Post Graduate	123	93	22	3	4	0	0	0	0	1	
<b>Census Region</b>											
Northeast	292	201	70	8	8	1	0	0	0	3	
Midwest	340	227	85	14	4	3	1	0	1	2	
South	585	388	148	23	8	8	0	1	2	3	
West	274	203	49	12	2	5	1	0	0	0	
<b>Day of Week</b>											
Weekday	994	695	220	35	17	12	1	0	1	6	
Weekend	497	324	132	22	5	5	1	1	2	2	
<b>Season</b>											
Winter	381	264	86	15	5	4	0	0	0	3	
Spring	408	269	104	12	9	9	0	1	1	2	
Summer	400	282	86	21	5	2	1	0	0	2	
Fall	302	204	76	9	3	2	1	0	2	1	
<b>Asthma</b>											
No	1387	950	327	53	20	15	2	1	1	8	
Yes	100	66	24	4	2	2	0	0	2	0	
DK	4	3	1	0	0	0	0	0	0	0	
<b>Angina</b>											
No	1451	990	344	55	22	17	2	1	3	8	
Yes	35	26	7	1	0	0	0	0	0	0	
DK	5	3	1	1	0	0	0	0	0	0	
<b>Bronchitis/emphysema</b>											
No	1411	972	322	55	22	17	2	1	3	8	
Yes	74	44	29	1	0	0	0	0	0	0	
DK	6	3	1	1	0	0	0	0	0	0	

Note: \* = Missing Data; "DK" = Don't Know; Refused = Respondents Refused To Answer; N= Sample Size  
Source: Tsang And Klepeis, 1996.



Table 16-22. Number of Minutes Spent in Activities Working with or Being Near Freshly Applied Paints (minutes/day)

Category	Population Group	N	Percentiles											
			1	2	5	10	25	50	75	90	95	98	99	100
Overall		276	0	0	1	2	15	60	121	121	121	121	121	121
Gender	Male	145	0	0	1	2	10	48	121	121	121	121	121	121
Gender	Female	131	0	0	1	3	15	120	121	121	121	121	121	121
Age (years)	1-4	7	3	3	3	3	5	15	121	121	121	121	121	121
Age (years)	5-11	12	5	5	5	15	20	45	120	120	121	121	121	121
Age (years)	12-17	20	0	0	0.5	3	8	45	75	121	121	121	121	121
Age (years)	18-64	212	0	0	1	2	11	60	121	121	121	121	121	121
Age (years)	> 64	20	0	0	0	2.5	17.5	90	121	121	121	121	121	121
Race	White	241	0	0	2	4	15	60	121	121	121	121	121	121
Race	Black	16	0	0	0	1	2.5	10	90	121	121	121	121	121
Race	Asian	3	20	20	20	20	20	30	60	60	60	60	60	60
Race	Some Others	2	10	10	10	10	10	20	30	30	30	30	30	30
Race	Hispanic	12	0	0	0	1	3.5	27.5	120.5	121	121	121	121	121
Hispanic	No	257	0	0	1	3	15	60	121	121	121	121	121	121
Hispanic	Yes	17	0	0	0	1	6	45	121	121	121	121	121	121
Employment	Full Time	145	0	1	2	3	10	60	121	121	121	121	121	121
Employment	Part Time	31	0	0	0	1	30	60	121	121	121	121	121	121
Employment	Not Employed	61	0	0	0	2	30	120	121	121	121	121	121	121
Education	< High School	13	0	0	0	1	5	45	121	121	121	121	121	121
Education	High School Graduate	74	0	1	1	5	20	120	121	121	121	121	121	121
Education	< College	72	0	0	2	2	12.5	105	121	121	121	121	121	121
Education	College Graduate	42	0	0	0	1	6	60	121	121	121	121	121	121
Education	Post Graduate	30	2	2	3	4.5	15	30	121	121	121	121	121	121
Census Region	Northeast	60	0	0	2	5	25	120	121	121	121	121	121	121
Census Region	Midwest	70	0	0	0	2	10	55	121	121	121	121	121	121
Census Region	South	90	0	0	1	2	10	47.5	121	121	121	121	121	121
Census Region	West	56	1	1	1	3	12.5	75	121	121	121	121	121	121
Day of Week	Weekday	222	0	0	1	2	15	60	121	121	121	121	121	121
Day of Week	Weekend	54	0	0	0	5	15	45	121	121	121	121	121	121
Season	Winter	67	0	1	2	3	15	60	121	121	121	121	121	121
Season	Spring	74	0	0	1	2	10	30	121	121	121	121	121	121
Season	Summer	76	0	0	0	2	13.5	90	121	121	121	121	121	121
Season	Fall	59	0	1	2	5	20	120	121	121	121	121	121	121
Asthma	No	257	0	0	1	2	15	60	121	121	121	121	121	121
Asthma	Yes	19	1	1	1	2	10	45	121	121	121	121	121	121
Angina	No	270	0	0	1	2	12	60	121	121	121	121	121	121
Angina	Yes	6	45	45	45	45	60	121	121	121	121	121	121	121
Bronchitis/emphysema	No	265	0	0	1	3	15	60	121	121	121	121	121	121
Bronchitis/emphysema	Yes	11	0	0	0	2	5	45	121	121	121	121	121	121

Note: A value of "121" for number of minutes signifies that more than 120 minutes were spent; n = doer sample size; percentiles are the percentage of doers below or equal to a given number of minutes.  
 Source: Tsang and Klepeis, 1996.



Table 16-23. Number of Minutes Spent in Activities Working with or Near Household Cleaning Agents Such as Scouring Powders or Ammonia (minutes/day)

Category	Population Group	N	Percentiles											
			1	2	5	10	25	50	75	90	95	98	99	100
Overall		905	0	0	0	1	4	10	20	60	121	121	121	121
Gender	Male	278	0	0	1	2	3	10	20	60	121	121	121	121
Gender	Female	627	0	0	0	1	4	10	20	60	120	121	121	121
Age (years)	1-4	21	0	0	0	0	5	10	15	20	30	121	121	121
Age (years)	5-11	26	1	1	2	2	3	5	15	30	30	30	30	30
Age (years)	12-17	41	0	0	0	0	2	5	10	40	60	60	60	60
Age (years)	18-64	672	0	0	1	2	5	10	20	60	121	121	121	121
Age (years)	> 64	127	0	0	0	1	3	5	15	30	60	120	121	121
Race	White	721	0	0	1	1	4	10	20	60	121	121	121	121
Race	Black	112	0	0	0	1	2	5	12	30	90	121	121	121
Race	Asian	16	0	0	0	5	5	10	15	20	30	30	30	30
Race	Some Others	19	2	2	2	3	5	10	20	30	60	60	60	60
Race	Hispanic	30	0	0	1	2.5	10	15	30	60	90	121	121	121
Hispanic	No	838	0	0	0	1	3	10	20	60	121	121	121	121
Hispanic	Yes	58	0	0	1	2	5	12.5	30	60	120	121	121	121
Employment	Full Time	422	0	0	1	1	4	10	30	60	121	121	121	121
Employment	Part Time	98	0	0	1	2	5	10	20	60	121	121	121	121
Employment	Not Employed	296	0	0	0	2	3	10	15	60	120	121	121	121
Education	< High School	76	0	0	1	2	2	12.5	30	120	121	121	121	121
Education	High School Graduate	304	0	0	0	2	5	10	20	60	120	121	121	121
Education	< College	204	0	0	0	1	4.5	10	30	120	121	121	121	121
Education	College Graduate	114	0	1	1	2	5	10	20	60	90	121	121	121
Education	Post Graduate	109	0	0	1	1	3	5	15	30	60	121	121	121
Census Region	Northeast	207	0	0	0	1	3	5	15	45	120	121	121	121
Census Region	Midwest	180	0	0	0	1	5	10	30	75	121	121	121	121
Census Region	South	309	0	0	1	2	4	10	20	60	120	121	121	121
Census Region	West	209	0	0	1	1	4	10	20	60	121	121	121	121
Day of Week	Weekday	580	0	0	0	1	3	10	20	60	121	121	121	121
Day of Week	Weekend	325	0	0	1	2	5	10	20	60	90	121	121	121
Season	Winter	240	0	0	0	2	3	10	20	75	121	121	121	121
Season	Spring	220	0	0	0	1	3	10	17.5	52.5	104	121	121	121
Season	Summer	244	0	0	0	2	4	10	20	30	60	121	121	121
Season	Fall	201	0	0	1	2	5	10	30	90	121	121	121	121
Asthma	No	826	0	0	0	1	3	10	20	60	120	121	121	121
Asthma	Yes	79	0	0	1	2	5	10	30	120	121	121	121	121
Angina	No	868	0	0	0	1	4	10	20	60	121	121	121	121
Angina	Yes	33	0	0	2	2	5	5	30	120	121	121	121	121
Bronchitis/emphysema	No	843	0	0	0	1	4	10	20	60	120	121	121	121
Bronchitis/emphysema	Yes	60	0	0	1	2	3.5	10	32.5	120.5	121	121	121	121

Note: A value of "121" for number of minutes signifies that more than 120 minutes were spent; n = doer sample size; percentiles are the percentage of doers below or equal to a given number of minutes.

Source: Tsang and Klepeis, 1996.



Table 16-24. Number of Minutes Spent in Activities (at home or elsewhere) Working with or Near Floorwax, Furniture Wax or Shoe Polish (minutes/day)

Category	Population Group	N	Percentiles											
			1	2	5	10	25	50	75	90	95	98	99	100
Overall		325	0	0	2	2	5	10	30	60	121	121	121	121
Gender	Male	96	0	0	1	2	5	11	30	121	121	121	121	121
Gender	Female	229	0	0	2	3	5	10	30	60	121	121	121	121
Age (years)	1-4	13	0	0	0	5	10	15	20	60	121	121	121	121
Age (years)	5-11	21	0	0	2	2	3	5	10	35	60	120	120	120
Age (years)	12-17	15	0	0	0	1	2	10	25	45	121	121	121	121
Age (years)	18-64	238	0	0	2	3	5	15	30	120	121	121	121	121
Age (years)	> 64	34	0	0	0	2	5	10	20	35	121	121	121	121
Race	White	267	0	0	2	2	5	10	30	60	121	121	121	121
Race	Black	32	2	2	2	5	5	15	30	60	121	121	121	121
Race	Asian	1	4	4	4	4	4	4	4	4	4	4	4	4
Race	Some Others	6	0	0	0	0	2	22.5	60	121	121	121	121	121
Race	Hispanic	18	1	1	1	4	5	12.5	30	120	121	121	121	121
Hispanic	No	291	0	0	2	2	5	10	30	60	121	121	121	121
Hispanic	Yes	31	1	1	4	5	5	10	30	90	120	121	121	121
Employment	Full Time	150	0	0.5	2	3	5	15	30	121	121	121	121	121
Employment	Part Time	32	3	3	5	5	10	15	30	60	121	121	121	121
Employment	Not Employed	92	0	0	1	2	5	10	20	60	120	121	121	121
Education	< High School	26	2	2	3	5	5	10	15	60	60	60	60	60
Education	High School Graduate	115	0	0	2	3	5	12	30	120	121	121	121	121
Education	< College	70	0	1	2	3	10	15	30	75	121	121	121	121
Education	College Graduate	29	2	2	3	5	7	30	60	121	121	121	121	121
Education	Post Graduate	31	0	0	0	2	4	10	30	60	121	121	121	121
Census Region	Northeast	77	0	0	2	3	5	10	30	60	121	121	121	121
Census Region	Midwest	70	0	0	1	2	5	10	25	90	121	121	121	121
Census Region	South	125	0	0	2	2	5	10	30	120	121	121	121	121
Census Region	West	53	0	0	1	3	5	15	30	120	121	121	121	121
Day of Week	Weekday	210	0	0	2	2	5	10	30	120	121	121	121	121
Day of Week	Weekend	115	0	0	2	3	5	10	30	60	120	121	121	121
Season	Winter	92	0	1	2	4	7	13.5	30	121	121	121	121	121
Season	Spring	78	0	0	1	2	5	15	30	60	121	121	121	121
Season	Summer	81	0	0	2	2	5	15	30	120	121	121	121	121
Season	Fall	74	0	0	0	2	5	10	15	60	121	121	121	121
Asthma	No	296	0	0	2	2	5	10	30	60	121	121	121	121
Asthma	Yes	29	0	0	0	2	5	15	30	121	121	121	121	121
Angina	No	312	0	0	2	2	5	10	30	60	121	121	121	121
Angina	Yes	12	0	0	0	2	4	10	12.5	30	121	121	121	121
Bronchitis/emphysema	No	302	0	0	2	2	5	10	30	90	121	121	121	121
Bronchitis/emphysema	Yes	22	0	0	2	2	5	10	15	20	121	121	121	121

Note: A value of "121" for number of minutes signifies that more than 120 minutes were spent; n = doer sample size; percentiles are the percentage of doers below or equal to a given number of minutes.  
 Source: Tsang and Klepeis, 1996.



Table 16-25. Number of Minutes Spent in Activities Working with or Being Near Glue (minutes/day)

Category	Population Group	N	Percentiles											
			1	2	5	10	25	50	75	90	95	98	99	100
Overall		294	0	0	0	1	5	15	60	121	121	121	121	121
Gender	Male	151	0	0	0	2	5	15	70	121	121	121	121	121
Gender	Female	143	0	0	0	1	5	15	30	121	121	121	121	121
Age (years)	1-4	6	0	0	0	0	30	30	30	50	50	50	50	50
Age (years)	5-11	36	2	2	3	5	5	12.5	25	30	60	120	120	120
Age (years)	12-17	34	0	0	1	2	5	10	30	30	60	120	120	120
Age (years)	18-64	207	0	0	0	1	5	20	90	121	121	121	121	121
Age (years)	> 64	10	0	0	0	0	0	3.5	60	120.5	121	121	121	121
Race	White	241	0	0	0	1	5	15	60	121	121	121	121	121
Race	Black	28	0	0	0	2	5	12.5	45	121	121	121	121	121
Race	Asian	4	10	10	10	10	12.5	17.5	40	60	60	60	60	60
Race	Some Others	7	1	1	1	1	3	30	90	120	120	120	120	120
Race	Hispanic	12	5	5	5	5	5	27.5	90	121	121	121	121	121
Hispanic	No	260	0	0	0	1	5	15	60	121	121	121	121	121
Hispanic	Yes	27	3	3	5	5	5	30	120	121	121	121	121	121
Employment	Full Time	150	0	0	0	1	5	20	120	121	121	121	121	121
Employment	Part Time	24	1	1	2	3	10	27.5	90	121	121	121	121	121
Employment	Not Employed	46	0	0	0	0	2	10	30	121	121	121	121	121
Education	< High School	11	0	0	0	0	1	5	10	60	121	121	121	121
Education	High School Graduate	69	0	0	0	1	5	20	90	121	121	121	121	121
Education	< College	66	0	0	0	1	5	27.5	121	121	121	121	121	121
Education	College Graduate	37	0	0	0	1	5	15	30	121	121	121	121	121
Education	Post Graduate	32	0	0	0	1	5	15	60	121	121	121	121	121
Census Region	Northeast	55	0	0	0	1	5	20	60	121	121	121	121	121
Census Region	Midwest	71	0	0	1	2	5	15	60	121	121	121	121	121
Census Region	South	98	0	0	0	1	5	15	60	121	121	121	121	121
Census Region	West	70	0	0	0	1	5	15	60	121	121	121	121	121
Day of Week	Weekday	228	0	0	0	1	5	15	60	121	121	121	121	121
Day of Week	Weekend	66	0	0	0	1	5	15	60	121	121	121	121	121
Season	Winter	85	0	0	0	2	5	15	45	121	121	121	121	121
Season	Spring	74	0	0	0	2	5	10	30	121	121	121	121	121
Season	Summer	66	0	0	0	1	10	20	121	121	121	121	121	121
Season	Fall	69	0	0	0	1	5	15	60	121	121	121	121	121
Asthma	No	266	0	0	0	1	5	15	60	121	121	121	121	121
Asthma	Yes	28	0	0	0	1	5	17.5	40	121	121	121	121	121
Angina	No	290	0	0	0	1	5	15	60	121	121	121	121	121
Angina	Yes	3	1	1	1	1	1	121	121	121	121	121	121	121
Bronchitis/emphysema	No	283	0	0	0	1	5	15	60	121	121	121	121	121
Bronchitis/emphysema	Yes	11	1	1	1	1	2	30	121	121	121	121	121	121

Note: A value of "121" for number of minutes signifies that more than 120 minutes were spent; n = doer sample size; percentiles are the percentage of doers below or equal to a given number of minutes.

Source: Tsang and Klepeis, 1996.



Table 16-26. Number of Minutes Spent in Activities Working with or Near Solvents, Fumes or Strong Smelling Chemicals (minutes/day)

Category	Population Group	N	Percentiles											
			1	2	5	10	25	50	75	90	95	98	99	100
Overall		495	0	0	0	2	5	20	121	121	121	121	121	121
Gender	Male	258	0	0	1	2	5	30	121	121	121	121	121	121
Gender	Female	237	0	0	0	1	5	15	90	121	121	121	121	121
Age (years)	1-4	7	0	0	0	0	1	5	60	121	121	121	121	121
Age (years)	5-11	16	0	0	0	2	5	5	17.5	45	70	70	70	70
Age (years)	12-17	38	0	0	0	0	5	10	60	121	121	121	121	121
Age (years)	18-64	407	0	0	1	2	5	30	121	121	121	121	121	121
Age (years)	> 64	21	0	0	0	0	2	5	15	121	121	121	121	121
Race	White	413	0	0	0	2	5	20	121	121	121	121	121	121
Race	Black	40	0	0	1	3.5	9	60	121	121	121	121	121	121
Race	Asian	8	5	5	5	5	10	37.5	120.5	121	121	121	121	121
Race	Some Others	8	2	2	2	2	2.5	5	60	121	121	121	121	121
Race	Hispanic	23	0	0	0	0	5	30	121	121	121	121	121	121
Hispanic	No	449	0	0	0	2	5	20	121	121	121	121	121	121
Hispanic	Yes	41	0	0	0	0	5	20	121	121	121	121	121	121
Employment	Full Time	299	0	0	1	2	10	30	121	121	121	121	121	121
Employment	Part Time	44	0	0	2	2	5	22.5	121	121	121	121	121	121
Employment	Not Employed	91	0	0	0	0	2	10	60	121	121	121	121	121
Education	< High School	35	0	0	1	2	5	15	121	121	121	121	121	121
Education	High School Graduate	138	0	0	1	2	5	30	121	121	121	121	121	121
Education	< College	128	0	0	1	2	5	30	121	121	121	121	121	121
Education	College Graduate	69	0	0	0	1	5	30	121	121	121	121	121	121
Education	Post Graduate	60	0	0	0	1.5	5	27.5	121	121	121	121	121	121
Census Region	Northeast	101	0	0	2	2	5	20	121	121	121	121	121	121
Census Region	Midwest	122	0	0	0	2	5	30	121	121	121	121	121	121
Census Region	South	165	0	0	0	2	5	20	121	121	121	121	121	121
Census Region	West	107	0	0	0	2	5	20	121	121	121	121	121	121
Day of Week	Weekday	362	0	0	0	2	5	30	121	121	121	121	121	121
Day of Week	Weekend	133	0	0	0	2	5	15	90	121	121	121	121	121
Season	Winter	128	0	0	0	2	5	20	95	121	121	121	121	121
Season	Spring	127	0	0	0	1	5	20	121	121	121	121	121	121
Season	Summer	149	0	0	1	2	5	21	121	121	121	121	121	121
Season	Fall	91	0	0	1	2	5	30	121	121	121	121	121	121
Asthma	No	445	0	0	0	2	5	20	121	121	121	121	121	121
Asthma	Yes	50	0	0	1	1	5	15	121	121	121	121	121	121
Angina	No	489	0	0	0	2	5	20	121	121	121	121	121	121
Angina	Yes	6	0	0	0	0	2	15	121	121	121	121	121	121
Bronchitis/emphysema	No	469	0	0	0	2	5	20	121	121	121	121	121	121
Bronchitis/emphysema	Yes	26	2	2	2	2	5	17.5	60	121	121	121	121	121

Note: A Value of "121" for Number of Minutes Signifies That More than 120 Minutes Were Spent; N = Doer Sample Size; Percentiles Are the Percentage of Doers below or Equal to a Given Number of Minutes.  
Source: Tsang and Klepeis, 1996.





Table 16-27. Number of Minutes Spent in Activities Working with or Near Stain or Spot Removers (minutes/day)

Category	Population Group	N	Percentiles											
			1	2	5	10	25	50	75	90	95	98	99	100
Overall		109	0	0	0	0	2	5	15	60	121	121	121	121
Gender	Male	42	0	0	0	0	3	5	60	121	121	121	121	121
Gender	Female	67	0	0	0	0	2	5	10	20	30	60	120	120
Age (years)	1-4	3	0	0	0	0	0	0	3	3	3	3	3	3
Age (years)	5-11	3	3	3	3	3	3	5	5	5	5	5	5	5
Age (years)	12-17	7	0	0	0	0	5	15	35	60	60	60	60	60
Age (years)	18-64	87	0	0	0	0	2	5	15	60	121	121	121	121
Age (years)	> 64	9	0	0	0	0	2	3	15	121	121	121	121	121
Race	White	88	0	0	0	0	2	5	15	60	121	121	121	121
Race	Black	9	0	0	0	0	5	5	6	121	121	121	121	121
Race	Asian	2	5	5	5	5	5	7.5	10	10	10	10	10	10
Race	Some Others	3	0	0	0	0	0	2	3	3	3	3	3	3
Race	Hispanic	7	1	1	1	1	2	5	30	35	35	35	35	35
Hispanic	No	97	0	0	0	0	2	5	15	60	121	121	121	121
Hispanic	Yes	12	0	0	0	1	2	3	22.5	35	121	121	121	121
Employment	Full Time	62	0	0	0	0	2	5	15	120	121	121	121	121
Employment	Part Time	8	0	0	0	0	3	5	12.5	20	20	20	20	20
Employment	Not Employed	25	0	0	0	0	2	4	15	60	121	121	121	121
Education	< High School	6	3	3	3	3	3	20	30	60	60	60	60	60
Education	High School Graduate	34	0	0	0	0	1	4	10	120	121	121	121	121
Education	< College	22	0	0	0	1	3	5	15	20	121	121	121	121
Education	College Graduate	16	0	0	0	1	3	5	12.5	60	121	121	121	121
Education	Post Graduate	16	0	0	0	0	1	5	15	20	121	121	121	121
Census Region	Northeast	21	0	0	1	1	3	5	10	121	121	121	121	121
Census Region	Midwest	25	0	0	0	0	2	5	15	60	60	121	121	121
Census Region	South	38	0	0	0	0	2	5	15	60	120	121	121	121
Census Region	West	25	0	0	0	0	2	5	25	60	60	121	121	121
Day of Week	Weekday	75	0	0	0	0	2	5	15	120	121	121	121	121
Day of Week	Weekend	34	0	0	0	0	2	5	15	60	60	120	120	120
Season	Winter	26	0	0	0	0	2	5	15	60	120	120	120	120
Season	Spring	30	0	0	0	0.5	2	5	15	32.5	121	121	121	121
Season	Summer	37	0	0	0	0	2	5	20	121	121	121	121	121
Season	Fall	16	0	0	0	1	5	5	15	60	121	121	121	121
Asthma	No	100	0	0	0	0	2	5	15	60	120.5	121	121	121
Asthma	Yes	9	0	0	0	0	2	5	6	121	121	121	121	121
Angina	No	109	0	0	0	0	2	5	15	60	121	121	121	121
Bronchitis/emphysema	No	105	0	0	0	0	2	5	15	60	121	121	121	121
Bronchitis/emphysema	Yes	4	0	0	0	0	0.5	1.5	8.5	15	15	15	15	15

Note: A value of "121" for number of minutes signifies that more than 120 minutes were spent; n = doer sample size; percentiles are the percentage of doers below or equal to a given number of minutes.

Source: Tsang and Klepeis, 1996.



Table 16-28. Number of Minutes Spent in Activities Working with or Near Gasoline or Diesel-powered Equipment, Besides Automobiles (minutes/day)

Category	Population Group	N	Percentiles											
			1	2	5	10	25	50	75	90	95	98	99	100
Overall		390	0	0	1	3	10	60	121	121	121	121	121	121
Gender	Male	271	0	0	1	3	15	60	121	121	121	121	121	121
Gender	Female	119	1	1	1	2	8	30	120	121	121	121	121	121
Age (years)	1-4	14	0	0	0	1	5	22.5	120	121	121	121	121	121
Age (years)	5-11	12	1	1	1	3	7.5	25	50	60	60	60	60	60
Age (years)	12-17	25	2	2	5	5	13	35	120	121	121	121	121	121
Age (years)	18-64	312	0	0	1	3	15	60	121	121	121	121	121	121
Age (years)	> 64	26	2	2	2	3	10	25	90	121	121	121	121	121
Race	White	355	0	1	1	3	15	60	121	121	121	121	121	121
Race	Black	15	1	1	1	1	2	15	121	121	121	121	121	121
Race	Asian	8	0	0	0	0	5	11.5	17.5	90	90	90	90	90
Race	Some Others	2	1	1	1	1	1	23	45	45	45	45	45	45
Race	Hispanic	8	3	3	3	3	10	105.5	121	121	121	121	121	121
Hispanic	No	367	0	0	1	3	10	60	121	121	121	121	121	121
Hispanic	Yes	19	1	1	1	2	5	30	121	121	121	121	121	121
Employment	Full Time	237	0	0	1	2	20	90	121	121	121	121	121	121
Employment	Part Time	33	1	1	2	2	10	45	121	121	121	121	121	121
Employment	Not Employed	66	0	0	2	4	10	30	121	121	121	121	121	121
Education	< High School	33	0	0	1	2	6	60	121	121	121	121	121	121
Education	High School Graduate	135	1	1	2	5	20	90	121	121	121	121	121	121
Education	< College	89	0	1	2	3	15	60	121	121	121	121	121	121
Education	College Graduate	48	0	0	0	1	10	60	120	121	121	121	121	121
Education	Post Graduate	30	0	0	1	1.5	10	30	120	121	121	121	121	121
Census Region	Northeast	57	0	1	1	1	10	60	121	121	121	121	121	121
Census Region	Midwest	117	0	0	1	5	15	90	121	121	121	121	121	121
Census Region	South	151	0	1	2	3	10	60	121	121	121	121	121	121
Census Region	West	65	0	0	1	3	10	45	121	121	121	121	121	121
Day of Week	Weekday	278	0	0	1	2	10	60	121	121	121	121	121	121
Day of Week	Weekend	112	1	1	2	5	15	45	120	121	121	121	121	121
Season	Winter	97	0	0	1	2	10	60	121	121	121	121	121	121
Season	Spring	110	0	1	1	3	10	60	121	121	121	121	121	121
Season	Summer	119	0	1	2	5	15	60	121	121	121	121	121	121
Season	Fall	64	0	1	1	2	5	30	121	121	121	121	121	121
Asthma	No	361	0	0	1	3	10	60	121	121	121	121	121	121
Asthma	Yes	28	2	2	3	3	30	120.5	121	121	121	121	121	121
Angina	No	381	0	0	1	3	10	60	121	121	121	121	121	121
Angina	Yes	7	15	15	15	15	20	45	121	121	121	121	121	121
Bronchitis/emphysema	No	368	0	0	1	3	15	60	121	121	121	121	121	121
Bronchitis/emphysema	Yes	21	2	2	3	3	5	45	121	121	121	121	121	121

Note: A value of "121" for number of minutes signifies that more than 120 minutes were spent; n = doer sample size; percentiles are the percentage of doers below or equal to a given number of minutes.  
Source: Tsang and Klepeis, 1996.



Table 16-29. Number of Minutes Spent Using Any Microwave Oven (minutes/day)

Category	Population Group	N	Percentiles											
			1	2	5	10	25	50	75	90	95	98	99	100
Overall		2298	0	0	1	1	3	5	10	15	30	40	60	121
Gender	Male	948	0	0	1	1	2	5	10	15	30	40	67	121
Gender	Female	1350	0	0	1	1.5	3	5	10	20	30	42.5	60	121
Age (years)	5-11	62	0	0	0	1	1	2	5	10	15	20	30	30
Age (years)	12-17	141	0	0	0	1	2	3	5	10	15	30	30	60
Age (years)	18-64	1686	0	0	1	2	3	5	10	15	25	45	60	121
Age (years)	> 64	375	0	0	1	2	3	5	10	20	30	60	60	70
Race	White	1953	0	0	1	2	3	5	10	16	30	40	60	121
Race	Black	182	0	0	1	1	2	3	6	15	20	30	30	121
Race	Asian	38	0	0	1	1	3	5	10	20	30	60	60	60
Race	Some Others	29	0	0	2	2	3	5	10	30	30	50	50	50
Race	Hispanic	74	0	0	0	1	2	3	10	15	45	120	121	121
Hispanic	No	2128	0	0	1	1	3	5	10	15	30	35	60	121
Hispanic	Yes	139	0	0	0	1	2	5	10	20	30	120	120	121
Employment	Full Time	1114	0	0	1	1	3	5	10	15	30	34	60	121
Employment	Part Time	237	0	0	1	1	3	5	10	20	30	60	120	121
Employment	Not Employed	734	0	0	1	2	3	5	10	20	30	45	60	120
Education	< High School	190	0	0	0	1.5	3	5	10	20	33	60	121	121
Education	High School Graduate	717	0	0	1	2	3	5	10	20	30	45	60	121
Education	< College	518	0	0	1	2	3	5	10	18	30	60	120	121
Education	College Graduate	347	0	0	1	2	3	5	10	15	25	30	60	70
Education	Post Graduate	288	0	0	1	1	3	5	10	15	20	30	30	90
Census Region	Northeast	420	0	0	1	2	2	5	10	20	30	60	60	121
Census Region	Midwest	545	0	0	1	1	3	5	10	15	30	35	60	121
Census Region	South	831	0	0	1	2	3	5	10	16	30	45	60	121
Census Region	West	502	0	0	1	1	2	5	10	15	20	30	60	121
Day of Week	Weekday	1567	0	0	1	1	3	5	10	15	25	30	60	121
Day of Week	Weekend	731	0	0	1	1	2	5	10	20	30	50	120	121
Season	Winter	657	0	0	1	2	2	5	10	15	30	40	67	121
Season	Spring	577	0	0	1	2	3	5	10	20	30	45	60	120
Season	Summer	565	0	0	0	1	2	5	10	15	20	30	60	120
Season	Fall	499	0	0	1	1	2	5	10	20	30	45	120	121
Asthma	No	2109	0	0	1	1	2	5	10	15	30	40	60	121
Asthma	Yes	180	0	0	1	2	3	5	10	19	30	45	60	121
Angina	No	2212	0	0	1	1	2	5	10	15	30	40	60	121
Angina	Yes	72	0	0	1	2	3	6	10	15	30	45	60	60
Bronchitis/emphysema	No	2164	0	0	1	1	2	5	10	15	30	40	60	121
Bronchitis/emphysema	Yes	124	0	0	1	1	3	5	10	30	30	60	120	121

Note: A Value of "121" for number of minutes signifies that more than 120 minutes were spent; n = doer sample size; percentiles are the percentage of doers below or equal to a given number of minutes.

Source: Tsang and Klepeis, 1996.



Table 16-30. Number of Respondents Using a Humidifier at Home

	Total N	Frequency				DK
		Almost Every Day	3-5 Times a Week	1-2 Times a Week	1-2 Times a Month	
<b>Overall</b>	1047	300	121	107	495	24
<b>Gender</b>						
Male	455	135	53	48	208	11
Female	591	165	68	59	286	13
Refused	1	*	*	*	1	*
<b>Age (years)</b>						
*	16	3	1	3	7	2
1-4	111	33	16	7	53	2
5-11	88	18	10	12	46	2
12-17	83	21	7	5	49	1
18-64	629	183	77	70	287	12
> 64	120	42	10	10	53	5
<b>Race</b>						
White	879	268	98	79	414	20
Black	93	24	10	15	42	2
Asian	18	3	2	1	11	1
Some Others	20	1	3	4	12	*
Hispanic	30	2	7	8	13	*
Refused	7	2	1	*	3	1
<b>Hispanic</b>						
No	978	286	109	95	466	22
Yes	60	11	11	12	25	1
DK	5	3	*	*	2	*
Refused	4	*	1	0	2	1
<b>Employment</b>						
*	279	70	32	25	147	5
Full Time	416	124	43	44	194	11
Part Time	88	22	14	9	43	*
Not Employed	256	82	29	29	109	7
Refused	8	2	3	*	2	1
<b>Education</b>						
*	303	74	36	27	160	6
< High School	86	27	15	14	29	1
High School Graduate	251	85	27	28	104	7
< College	188	53	16	17	97	5
College Graduate	119	32	17	13	56	1
Post Graduate	100	29	10	8	49	4
<b>Census Region</b>						
Northeast	273	84	26	28	132	3
Midwest	326	102	37	32	142	13
South	302	83	42	31	141	5
West	146	31	16	16	80	3
<b>Day of Week</b>						
Weekday	698	196	83	70	335	14
Weekend	349	104	38	37	160	10
<b>Season</b>						
Winter	320	135	46	34	98	7
Spring	257	58	23	29	144	3
Summer	269	56	27	20	155	11
Fall	201	51	25	24	98	3
<b>Asthma</b>						
No	948	272	110	95	448	23
Yes	92	27	9	10	45	1
DK	7	1	2	2	2	*
<b>Angina</b>						
No	1015	290	116	103	482	24
Yes	24	8	4	3	9	*
DK	8	2	1	1	4	*
<b>Bronchitis/emphysema</b>						
No	994	278	117	102	473	24
Yes	48	21	3	4	20	*
DK	5	1	1	1	2	*

Note: \* = Missing Data; DK= Don't Know; Refused = Respondent Refused to Answer; N = Number of Respondents

Source: Tsang and Klepeis, 1996.



Table 16-31. Number of Respondents Indicating that Pesticides Were Applied by the Professional at Home to Eradicate Insects, Rodents, or Other Pests at Specified Frequencies

	Total N	Number of Times Over a 6-month Period Pesticides Were Applied by Professionals					DK
		None	1-2	3-5	6-9	10+	
<b>Overall</b>	1946	1057	562	134	150	20	23
<b>Gender</b>							
Male	897	498	248	64	64	11	12
Female	1048	558	314	70	86	9	11
Refused	1	1	*	*	*	*	*
<b>Age (years)</b>							
*	33	17	8	4	4	*	*
1-4	113	60	35	11	6	1	*
5-11	150	84	37	10	18	1	*
12-17	143	90	40	5	6	*	2
18-64	1264	660	387	89	97	15	16
> 64	243	146	55	15	19	3	5
<b>Race</b>							
White	1532	856	429	98	117	14	18
Black	231	107	78	20	17	4	5
Asian	24	13	10	1	*	*	*
Some Others	38	24	8	4	2	*	*
Hispanic	100	45	33	10	11	1	*
Refused	21	12	4	1	3	1	*
<b>Hispanic</b>							
No	1750	960	499	121	130	19	21
Yes	172	83	56	12	18	1	2
DK	8	5	3	*	*	*	*
Refused	16	9	4	1	2	*	*
<b>Employment</b>							
*	398	229	111	24	30	2	2
Full Time	855	463	252	59	60	11	10
Part Time	163	84	50	14	12	2	1
Not Employed	512	272	145	35	46	5	9
Refused	18	9	4	2	2	*	1
<b>Education</b>							
*	436	246	122	27	35	2	4
< High School	137	80	31	11	10	1	4
High School Graduate	483	265	140	26	38	9	5
< College	416	218	131	28	29	4	6
College Graduate	272	137	87	25	20	2	1
Post Graduate	202	111	51	17	18	2	3
<b>Census Region</b>							
Northeast	335	201	85	2	22	3	4
Midwest	318	202	84	17	13	*	2
South	875	404	298	63	86	11	13
West	418	250	95	34	29	6	4
<b>Day of Week</b>							
Weekday	1303	702	374	91	105	16	15
Weekend	643	355	188	43	45	4	8
<b>Season</b>							
Winter	466	247	129	29	46	9	6
Spring	449	240	128	30	43	3	5
Summer	584	324	172	40	34	6	8
Fall	447	246	133	35	27	2	4
<b>Asthma</b>							
No	1766	969	509	121	129	16	22
Yes	167	80	50	13	19	4	1
DK	13	8	3	*	2	*	*
<b>Angina</b>							
No	1880	1019	549	131	141	19	21
Yes	53	30	10	3	7	1	2
DK	13	8	3	*	2	*	*
<b>Bronchitis/emphysema</b>							
No	1833	1004	524	127	140	18	20
Yes	101	46	36	7	8	1	3
DK	12	7	2	*	2	1	*

Note: \* = Missing Data; DK= Don't know; Refused = Respondent Refused to Answer; N = Number of Respondents  
 Source: Tsang and Klepeis, 1996.



Table 16-32. Number of Respondents Reporting Pesticides Applied by the Consumer at Home To Eradicate Insects, Rodents, or Other Pests at Specified Frequencies

	Total N	Number of Times Over a 6-month Period Pesticides Applied by Resident					DK
		None	1-2	3-5	6-9	10+	
<b>Overall</b>	1946	721	754	286	73	83	29
<b>Gender</b>							
Male	897	318	367	135	31	35	11
Female	1048	403	386	151	42	48	18
Refused	1	*	1	*	*	*	*
<b>Age (years)</b>							
*	33	13	12	3	1	4	*
1-4	113	46	46	15	3	3	*
5-11	150	50	70	24	1	4	1
12-17	143	45	64	21	5	8	*
18-64	1264	473	477	192	48	55	19
> 64	243	94	85	31	15	9	9
<b>Race</b>							
White	1532	574	600	227	55	50	26
Black	231	81	77	36	10	25	2
Asian	24	4	15	3	1	1	*
Some Others	38	11	12	11	1	2	1
Hispanic	100	41	42	9	5	3	*
Refused	21	10	8	*	1	2	*
<b>Hispanic</b>							
No	1750	647	677	258	63	76	29
Yes	172	66	67	26	10	3	*
DK	8	2	3	1	*	2	*
Refused	16	6	7	1	*	2	*
<b>Employment</b>							
*	398	139	176	59	9	14	1
Full Time	855	298	342	131	37	35	12
Part Time	163	67	66	20	4	5	1
Not Employed	512	209	163	76	23	27	14
Refused	18	8	7	*	*	2	1
<b>Education</b>							
*	436	157	189	62	10	17	1
< High School	137	44	50	19	4	14	6
High School Graduate	483	184	196	53	21	18	11
< College	416	157	158	63	18	16	4
College Graduate	272	97	97	53	9	12	4
Post Graduate	202	82	64	36	11	6	3
<b>Census Region</b>							
Northeast	335	112	131	56	12	19	5
Midwest	318	108	145	35	12	12	6
South	875	363	316	119	30	37	10
West	418	138	162	76	19	15	8
<b>Day of Week</b>							
Weekday	1303	485	503	186	44	66	19
Weekend	643	236	251	100	29	17	10
<b>Season</b>							
Winter	466	190	153	75	18	21	9
Spring	449	170	192	51	15	16	5
Summer	584	204	233	89	21	27	10
Fall	447	157	176	71	19	19	5
<b>Asthma</b>							
No	1766	643	695	261	70	70	27
Yes	167	73	54	25	3	11	1
DK	13	5	5	*	*	2	1
<b>Angina</b>							
No	1880	696	731	276	70	80	27
Yes	53	21	19	8	3	1	1
DK	13	4	4	2	0	2	1
<b>Bronchitis/emphysema</b>							
No	1833	675	715	272	72	71	28
Yes	101	41	35	14	1	10	*
DK	12	5	4	*	*	2	1

Note: \* = Missing Data; DK= Don't know; Refused = Respondent Refused to Answer; N = Number of Respondents  
Source: Tsang and Klepeis, 1996.



Table 16-33. Number of Minutes Spent in Activities Working with or Near Pesticides, Including Bug Sprays or Bug Strips (minutes/day)

Category	Population Group	N	Percentiles											
			1	2	5	10	25	50	75	90	95	98	99	100
Overall		257	0	0	0	0	2	10	60	121	121	121	121	121
Gender	Male	121	0	0	1	1	2	10	90	121	121	121	121	121
Gender	Female	136	0	0	0		2	0	35	121	121	121	121	121
Age (years)	1-4	6	1	1	1	1	3	10	15	20	20	20	20	20
Age (years)	5-11	16	0	0	0	0	1.5	7.5	30	121	121	121	121	121
Age (years)	12-17	10	0	0	0	0	2	2.5	40	121	121	121	121	121
Age (years)	18-64	190	0	0	0	1	2	10	88	121	121	121	121	121
Age (years)	> 64	31	0	0	0	0	2	5	15	60	121	121	121	121
Race	White	199	0	0	0	1	2	10	60	121	121	121	121	121
Race	Black	36	0	0	0	0	1	3	20	121	121	121	121	121
Race	Asian	2	5	5	5	5	5	7.5	10	10	10	10	10	10
Race	Some Others	4	0	0	0	0	1.5	6.5	10	10	10	10	10	10
Race	Hispanic	15	0	0	0	0	2	20	121	121	121	121	121	121
Hispanic	No	231	0	0	0	0	2	10	60	121	121	121	121	121
Hispanic	Yes	25	0	0	0	1	5	20	121	121	121	121	121	121
Employment	Full Time	124	0	0	0	1	2	10	120.5	121	121	121	121	121
Employment	Part Time	26	0	0	0	1	2	5	60	121	121	121	121	121
Employment	Not Employed	75	0	0	0	0	2	5	30	121	121	121	121	121
Education	< High School	20	1	1	1	1	2.5	22.5	105.5	121	121	121	121	121
Education	High School Graduate	87	0	0	0	0	2	10	45	121	121	121	121	121
Education	< College	56	0	0	0	1	2	10	89	121	121	121	121	121
Education	College Graduate	29	0	0	0	0	1	10	90	121	121	121	121	121
Education	Post Graduate	29	0	0	0	0	3	10	30	121	121	121	121	121
Census Region	Northeast	45	0	0	1	2	5	10	88	121	121	121	121	121
Census Region	Midwest	51	0	0	0	0	2	10	121	121	121	121	121	121
Census Region	South	106	0	0	0	0	2	5	30	121	121	121	121	121
Census Region	West	55	0	0	0	1	2	10	45	121	121	121	121	121
Day of Week	Weekday	183	0	0	0	0	2	10	60	121	121	121	121	121
Day of Week	Weekend	74	0	0	0	1	3	10	30	121	121	121	121	121
Season	Winter	39	0	0	0	0	2	5	90	121	121	121	121	121
Season	Spring	78	0	0	0	0	2	10	60	121	121	121	121	121
Season	Summer	105	0	0	0	1	2	10	60	121	121	121	121	121
Season	Fall	35	0	0	0	0	1	10	60	121	121	121	121	121
Asthma	No	231	0	0	0	1	2	10	60	121	121	121	121	121
Asthma	Yes	24	0	0	0	0	1	5	90.5	121	121	121	121	121
Angina	No	244	0	0	0	0	2	10	60	121	121	121	121	121
Angina	Yes	8	1	1	1	1	2	5	75.5	121	121	121	121	121
Bronchitis/emphysema	No	240	0	0	0	0	2	10	60	121	121	121	121	121
Bronchitis/emphysema	Yes	14	1	1	1	2	2	5	30	121	121	121	121	121

Note: A value of "121" for number of minutes signifies that more than 120 minutes were spent; n = doer sample size.  
 Percentiles are the percentage of doers below or equal to a given number of minutes.  
 Source: Tsang and Klepeis, 1996.



Table 16-34. Amount and Frequency of Use of Various Cosmetic and Baby Products

Product Type	Amount of Product Per Application <sup>a</sup> (grams)	Average Frequency of Use (per day)			Upper 90th Percentile Frequency of Use (per day)		
		Survey Type			Survey Type		
		CTFA	Cosmetic Co.	Market Research Bureau <sup>b</sup>	CTFA	Cosmetic Co.	Market Research Bureau
Baby Lotion - baby use <sup>c</sup>	1.4	0.38	1.0	--	0.57	2.0	--
Baby Lotion - adult use	1.0	0.22	0.19	0.24 <sup>d</sup>	0.86	1.0	1.0 <sup>d</sup>
Baby Oil - baby use <sup>c</sup>	1.3	0.14	1.2	--	0.14	3.0	--
Baby Oil - adult use	5.0	0.06	0.13	--	0.29	0.57	--
Baby Powder - baby use <sup>c</sup>	0.8	5.36	1.5	0.35 <sup>d</sup>	8.43	3.0	1.0 <sup>d</sup>
Baby Powder - adult use	0.8	0.13	0.22	--	0.57	1.0	--
Baby Cream - baby use <sup>c</sup>	--	0.43	1.3	--	0.43	3.0	--
Baby Cream - adult use	--	0.07	0.10	--	0.14	0.14 <sup>e</sup>	--
Baby Shampoo - baby use <sup>c</sup>	0.5	0.14	--	0.11 <sup>f</sup>	0.14	--	0.43 <sup>f</sup>
Baby Shampoo - adult use	5.0	0.02	--	--	0.86 <sup>e</sup>	--	--
Bath Oils	14.7	0.08	0.19	0.22 <sup>g</sup>	0.29	0.86	1.0 <sup>g</sup>
Bath Tablets	--	0.003	0.008	--	0.14 <sup>e</sup>	0.14 <sup>e</sup>	--
Bath Salts	18.9	0.006	0.013	--	0.14 <sup>e</sup>	0.14 <sup>e</sup>	--
Bubble Baths	11.8	0.088	0.13	--	0.43	0.57	--
Bath Capsules	--	0.018	0.019	--	0.29 <sup>e</sup>	0.14 <sup>e</sup>	--
Bath Crystals	--	0.006	--	--	0.29 <sup>e</sup>	0.14 <sup>e</sup>	--
Eyebrow Pencil	--	0.27	0.49	--	1.0	1.0	--
Eyeliner	--	0.42	0.68	0.27	1.43	1.0	1.0
Eye Shadow	--	0.69	0.78	0.40	1.43	1.0	1.0
Eye Lotion	--	0.094	0.34	--	0.43	1.0	--
Eye Makeup Remover	--	0.29	0.45	--	1.0	1.0	--
Mascara	--	0.79	0.87	0.46	1.29	1.0	1.5
Under Eye Cover	--	0.79	--	--	0.29	--	--
Blusher & Rouge	0.011	1.18	1.24	0.55	2.0	1.43	1.5
Face Powders	0.085	0.35	0.67	0.33	1.29	1.0	1.0
Foundations	0.265	0.46	0.78	0.47	1.0	1.0	1.5
Leg and Body Paints	--	0.003	0.011	--	0.14 <sup>e</sup>	0.14 <sup>e</sup>	--
Lipstick & Lip Gloss	--	1.73	1.23	2.62	4.0	2.86	6.0
Makeup Bases	0.13	0.24	0.64	--	0.86	1.0	--
Makeup Fixatives	--	0.052	0.12	--	0.14	1.0	--
Sunscreen	3.18	0.003	--	0.002	0.14 <sup>e</sup>	--	0.005
Colognes & Toilet Water	0.65	0.68	0.85	0.56	1.71	1.43	1.5
Perfumes	0.23	0.29	0.26	0.38	0.86	1.0	1.5





Table 16-34. Amount and Frequency of Use of Various Cosmetic and Baby Products (continued)

Product Type	Amount of Product Per Application <sup>a</sup> (grams)	Average Frequency of Use (per day)			Upper 90th Percentile Frequency of Use (per day)		
		Survey Type			Survey Type		
		CTFA	Cosmetic Co.	Market Research Bureau <sup>b</sup>	CTFA	Cosmetic Co.	Market Research Bureau
Powders	2.01	0.18	0.39	--	1.0	1.0	--
Sachets	0.2	0.0061	0.034	--	0.14 <sup>e</sup>	0.14 <sup>e</sup>	--
Fragrance Lotion	--	0.0061	--	--	0.29 <sup>e</sup>	--	--
Hair Conditioners	12.4	0.4	0.40	0.27	1.0	1.0	0.86
Hair Sprays	--	0.25	0.55	0.32	1.0	1.0	1.0
Hair Rinses	12.7	0.064	0.18	--	0.29	1.0	--
Shampoos	16.4	0.82	0.59	0.48	1.0	1.0	1.0
Tonics and Dressings	2.85	0.073	0.021	--	0.29	0.14 <sup>e</sup>	--
Wave Sets	2.6	0.003 <sup>h</sup>	0.040	--	-- <sup>h</sup>	0.14	--
Dentifrices	--	1.62	0.67	2.12	2.6	2.0	4.0
Mouthwashes	--	0.42	0.62	0.58	1.86	1.14	1.5
Breath Fresheners	--	0.052	0.43	0.46	0.14	1.0	0.57
Nail Basecoats	0.23	0.052	0.13	--	0.29	0.29	--
Cuticle Softeners	0.66	0.040	0.10	--	0.14	0.29	--
Nail Creams & Lotions	0.56	0.070	0.14	--	0.29	0.43	--
Nail Extenders	--	0.003	0.013	--	0.14 <sup>e</sup>	0.14 <sup>e</sup>	--
Nail Polish & Enamel	0.28	0.16	0.20	0.07	0.71	0.43	1.0
Nail Polish & Enamel Remover	3.06	0.088	0.19	--	0.29	0.43	--
Nail Undercoats	--	0.049	0.12	--	0.14	0.29	--
Bath Soaps	2.6	1.53	0.95	--	3.0	1.43	--
Underarm Deodorants	0.52	1.01	0.80	1.10	1.29	1.29	2.0
Douches	--	0.013	0.089	0.085	0.14 <sup>e</sup>	0.29	0.29
Feminine Hygiene Deodorants	--	0.021	0.084	0.05	1.0 <sup>e</sup>	0.29	0.14
Cleansing Products (cold creams, cleansing lotions liquids & pads)	1.7	0.63	0.80	0.54	1.71	2.0	1.5
Depilatories	--	0.0061	0.051	0.009	0.016	0.14	0.033
Face, Body & Hand Preps (excluding shaving preps)	3.5	0.65	--	1.12	2.0	--	2.14
Foot Powder & Sprays	--	0.061	0.079	--	0.57 <sup>e</sup>	0.29	--
Hormones	--	0.012	0.028	--	0.57 <sup>e</sup>	0.14 <sup>e</sup>	--
Moisturizers	0.53	0.98	0.88	0.63	2.0	1.71	1.5
Night Skin Care Products	1.33	0.18	0.50	--	1.0	1.0	--



Table 16-34. Amount and Frequency of Use of Various Cosmetic and Baby Products (continued)							
Product Type	Amount of Product Per Application <sup>a</sup> (g)	Average Frequency of Use (per day)			Upper 90th Percentile Frequency of Use (per day)		
		Survey Type			Survey Type		
		CTFA	Cosmetic Co.	Market Research Bureau <sup>b</sup>	CTFA	Cosmetic Co.	Market Research Bureau
Paste Masks (mud packs)	3.7	0.027	0.20	--	0.14	0.43	--
Skin Lighteners	--	--	0.024	--	-- <sup>d</sup>	0.14 <sup>d</sup>	--
Skin Fresheners & Astringents	2.0	0.33	0.56	--	1.0	1.43	--
Wrinkle Smoothers (removers)	0.38	0.021	0.15	--	1.0 <sup>d</sup>	1.0	--
Facial Cream	0.55	0.0061	--	--	0.0061	--	--
Permanent Wave	101	0.003	--	0.001	0.0082	--	0.005
Hair Straighteners	0.156	0.0007	--	--	0.005 <sup>d</sup>	--	--
Hair Dye	--	0.001	--	0.005	0.004 <sup>d</sup>	--	0.014
Hair Lighteners	--	0.0003	--	--	0.005 <sup>d</sup>	--	--
Hair Bleaches	--	0.0005	--	--	0.02 <sup>d</sup>	--	--
Hair Tints	--	0.0001	--	--	0.005 <sup>d</sup>	--	--
Hair Rinse (coloring)	--	0.0004	--	--	0.02 <sup>d</sup>	--	--
Shampoo (coloring)	--	0.0005	--	--	0.02 <sup>d</sup>	--	--
Hair Color Spray	--	--	--	--	-- <sup>d</sup>	--	--
Shave Cream	1.73	--	--	0.082	--	--	0.36

<sup>a</sup> Values reported are the averages of the responses reported by the twenty companies interviewed. (--'s) indicate no data available.

<sup>b</sup> The averages shown for the Market Research Bureau are not true averages - this is due to the fact that in many cases the class of most frequent users were indicated by "1 or more" also ranges were used in many cases, i.e., "10-12." The average, therefore, is underestimated slightly. The "1 or more" designation also skew the 90th percentile figures in many instances. The 90th percentile values may, in actuality, be somewhat higher for many products.

<sup>c</sup> Average usage among users only for baby products.

<sup>d</sup> Usage data reflected "entire household" use for both baby lotion and baby oil.

<sup>e</sup> Fewer than 10% of individuals surveyed used these products. Value listed is lowest frequency among individuals reporting usage. In the case of wave sets, skin lighteners, and hair color spray, none of the individuals surveyed by the CTFA used this product during the period of the study.

<sup>f</sup> Usage data reflected "entire household" use.

<sup>g</sup> Usage data reflected total bath product usage.

<sup>h</sup> None of the individuals surveyed reported using this product.

Source: CTFA, 1983.



Table 16-35. Summary of Consumer Products Use Studies

Study	Study Size	Approach	Relevant Population	Comments
<u>KEY STUDIES</u>				
Abt, 1992	4,997 product interviews; 527 mailed questionnaires	Direct - interviews and questionnaires	Adults	Random digit dialing method used to select sample. Information on use of 3 products containing methyl chloride was requested.
Westat, 1987a	4,920 individuals	Direct - questionnaire	18+ yrs selected to be representative of US population	Waksberg Method (random digit dialing) used to select sample. Respondents asked to recall use in past 2 months of 32 categories of household products containing methyl chloride.
Westat, 1987b	193 households	Direct - telephone survey; 2 post-survey validation efforts: 30 reinterviewed, then another 50 reinterviewed	Adult household members who do cleaning tasks in household	Waksberg Method (random digit dialing) used to select sample. Household use of cleaning products requested. Phone survey during end of year holidays may reflect biased usage data. Two validation resurveys conducted 3 months after survey.
Westat, 1987c	777 households	Direct - telephone survey; 1 post-survey validation effort conducted with 30 reinterviewed	Household members who do painting tasks in household	Waksberg Method (random digit dialing) used to select sample. Painting product use information in past 12 months was requested. One validation resurvey conducted 3 months after survey.
Tsang and Klepeis, 1996	9,386 individuals	Direct - interviews and questionnaires	Representative of U.S. general population	National Human Activity Patterns Survey (NHAPS). Participants selected using random Dial Digit (RDD) and Computer Assisted Telephone Interviewing (CATI). 24- hour diary data, and follow-up questions; nationally representative; represent all seasons, age groups, and genders.
<u>RELEVANT STUDY</u>				
CTFA, 1983	Survey 1: 47 women employees and relatives or employees Survey 2: 1,129 cosmetics purchasers Survey 3: 19,035 females	Survey 1: Direct - 1 wk prospective survey Survey 2: Direct - prospective survey Survey 3: Direct - 9.5 months. prospective survey	Survey 1: 16-61 yr old females Survey 2: Customers of cosmetic manufacturer Survey 3: Market research company sampled female consumers nationwide	Interviewees asked to recall their use of cosmetics and some baby products during a specific past time period. Surveys 1 and 2 had small populations, but Survey 3 had large population selected to be representative of U.S. population



**APPENDIX 16A**

**SIMMONS MARKET RESEARCH DATA**



**Appendix 16A**

Table 16A-1. Volumes Included in 1992 Simmons Study

The volumes included in the Media series are as follows:	
M1	Publications: Total Audiences
M2	Publications: Qualitative Measurements And In-Home Audiences
M3	Publications: Duplication Of Audiences
M4	Multi-Media Audiences: Adults
M5	Multi-Media Audiences: Males
M6	Multi-Media Audiences: Females and Mothers
M7	Business To Business
M8	Multi-Media Reach and Frequency and Television Attentiveness & Special Events
The following volumes are included in the Product series:	
P1	Automobiles, cycles, Trucks & Vans
P2	Automotive Products & Services
P3	Travel
P4	Banking, Investments, Insurance, Credit Cards & Contributions, Memberships & Public Activities
P5	Games & Toys, Children's & Babies' Apparel & Specialty Products
P6	Computers, Books, Discs, Records, Tapes, Stereo, Telephones, TV & Video
P7	Appliances, Garden Care, Sewing & Photography
P8	Home Furnishings & Home Improvements
P9	Sports & Leisure
P10	Restaurants, Stores & Grocery Shopping
P11	Direct Mail & Other In-Home Shopping, Yellow Pages, Florist, Telegrams, Faxes & Greeting Cards
P12	Jewelry, Watches, Luggage, Writing Tools & Men's Apparel
P13	Women's Apparel
P14	Distilled Spirits, Mixed Drinks, Malt Beverages, Wine & Tobacco Products
P15	Coffee, Tea, Cocoa, Milk, Soft Drinks, Juices & Bottled Water
P16	Dairy Products, Desserts, Baking & Bread Products
P17	Cereals & Spreads, Rice, Pasta, Pizza, Mexican Foods, Fruits & Vegetables
P18	Soup, Meat, Fish, Poultry, Condiments & Dressings
P19	Chewing Gum, Candy, Cookies & Snacks
P20	Soap, Laundry, Paper Products & Kitchen Wraps
P21	Household Cleaners, Room Deodorizers, Pest Controls & Pet Foods
P22	Health Care Products & Remedies
P23	Oral Hygiene Products, Skin Care, Deodorants & Drug Stores
P24	Hair Care, Shaving Products & Fragrances
P25	Women's Beauty Aids, Cosmetics & Personal Products
P26	Relative Volume of Consumption

# TABLE OF CONTENTS

Page No.

17.	RESIDENTIAL BUILDING CHARACTERISTICS .....	1
17.1.	INTRODUCTION .....	1
17.2.	BUILDING CHARACTERISTICS .....	2
17.2.1.	Key Volumes of Residence <b>Studies</b> .....	2
17.2.2.	Volumes and Surface Areas of Rooms .....	4
17.2.3.	Mechanical System Configurations .....	6
17.2.4.	Type of Foundation .....	7
17.3.	TRANSPORT RATES .....	8
17.3.1.	Background .....	8
17.3.2.	Air Exchange Rates .....	10
<b>17.3.3.</b>	<b>Infiltration Models</b> .....	12
17.3.4.	Deposition and Filtration .....	14
17.3.5.	Interzonal Airflows .....	15
17.3.6.	Water Uses .....	15
17.3.7.	House Dust and Soil .....	19
17.4.	SOURCES .....	20
17.4.1.	Source Descriptions for Airborne Contaminants .....	20
17.4.2.	Source Descriptions for Waterborne Contaminants .....	22
17.4.3.	Soil and House Dust Sources .....	22
<b>17.5.</b>	<b>ADVANCED CONCEPTS</b> .....	23
17.5.1.	Uniform Mixing Assumption .....	23
17.5.2.	Reversible Sinks .....	23
17.6.	RECOMMENDATIONS .....	23
17.7.	REFERENCES FOR CHAPTER 17 .....	24



Chapter 17 - Residential Building Characteristics

17. RESIDENTIAL BUILDING CHARACTERISTICS

17.1. INTRODUCTION

Unlike previous chapters in this handbook which focus on human behavior or characteristics that affect exposure, this chapter focuses on residence characteristics. Assessment of exposure in residential settings requires information on the availability of the chemical(s) of concern at the point of exposure, characteristics of the structure and microenvironment that affect exposure, and human presence within the residence. The purpose of this chapter is to provide data that are available on residence characteristics that affect exposure in an indoor environment. Source-receptor relationships in residential exposure scenarios can be complex due to interactions among sources, and transport/transformation processes that result from chemical-specific and building-specific factors. Figure 17-1 illustrates the complex factors that must be considered when conducting exposure assessments in a residential setting. In addition to sources within the building, chemicals of concern may enter the indoor environment from outdoor air, soil, gas, water supply, tracked-in soil, and industrial work clothes worn by the residents. Indoor concentrations are affected by loss mechanisms, also illustrated in Figure 17-1, involving chemical reactions, deposition to and re-emission from surfaces, and transport out of the building. Particle-bound

chemicals can enter indoor air through resuspension. Indoor air concentrations of gas-phase organic chemicals are affected by the presence of reversible sinks formed by a wide range of indoor materials. In addition, the activity of human receptors greatly affects their exposure as they move from room to room, entering and leaving the exposure scene.

Inhalation exposure assessments in residential and other indoor settings are modeled by considering the building as an assemblage of one or more well-mixed zones. A zone is defined as one room, a group of interconnected rooms, or an entire building. This macroscopic level, well-mixed perspective forms the basis for interpretation of measurement data as well as simulation of hypothetical scenarios. Exposure assessment models on a macroscopic level incorporate important physical factors and processes. These well-mixed, macroscopic models have been used to perform indoor air quality simulations (Axley, 1989), as well as indoor air exposure assessments (McKone, 1989; Ryan, 1991). Nazaroff and Cass (1986) and Wilkes et al. (1992) have used code-intensive computer programs featuring finite difference or finite element numerical techniques to model mass balance. A simplified approach using desk top spreadsheet programs has been used by Jennings et al. (1985).

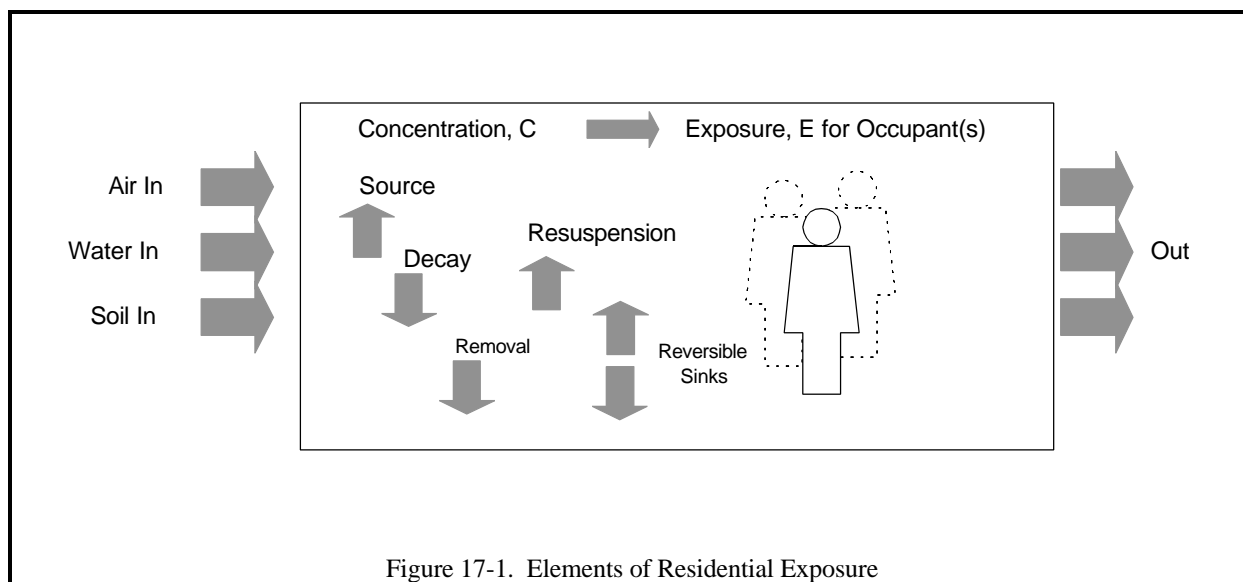



Chapter 17 - Residential Building Characteristics

In order to model mass balance of indoor contaminants, the indoor air volume is represented as a network of interconnected zones. Because conditions in a given zone are determined by interactions with other connecting zones, the multizone model is stated as a system of simultaneous equations. The mathematical framework for modeling indoor air has been reviewed by Sinden (1978) and Sandberg (1984).

Indoor air quality models typically are not software products that can be purchased as "off-the-shelf" items. Most existing software models are research tools that have been developed for specific purposes and are being continuously refined by researchers. Leading examples of indoor air models implemented as software products are as follows:

- CONTAM -- developed at the National Institute of Standards and Technology (NIST) with support from U.S. EPA and the U.S. Department of Energy (DOE) (Axley, 1988; Grot, 1991; Walton, 1993);
- EXPOSURE -- developed at the Indoor Air Branch of U.S. EPA Air and Energy Engineering Research Laboratory (EPA/AEERL) (Sparks, 1988, 1991);
- MCCEM -- the Multi-Chamber Consumer Exposure Model developed for U.S. EPA Office of Pollution Prevention and Toxics (EPA/OPPT) (GEOMET, 1989; Koontz and Nagda, 1991); and
- THERdbASE -- the Total Human Exposure Relational Data Base and Advanced Simulation Environment software developed by researchers at the Harry Reid Center for Environmental Studies at University Nevada, Las Vegas (UNLV) (Pandian et al., 1993).

Section 17.2 of this chapter summarizes existing data on building characteristics (volumes, surface areas, mechanical systems, and types of foundations). Section 17.3 summarizes transport phenomena that affect chemical transport (airflow, chemical-specific deposition and filtration, and effects of water supply and soil tracking). Section 17.4 provides information on various types of indoor sources associated with airborne exposure,

waterborne sources, and soil/house dust sources. Section 17.5 summarizes advanced concepts.

**17.2. BUILDING CHARACTERISTICS**  
**17.2.1. Key Volumes of Residence Studies**

*Versar (1990) - Database on Perfluorocarbon Tracer (PFT) Ventilation Measurements* - A database of time-averaged air exchange and interzonal airflow measurements in more than 4,000 residences has been compiled by Versar (1990) to allow researchers to access these data (see Section 17.3.2). These data were collected between 1982 and 1987. The residences that appear in this database are not a random sample of U.S. homes; however, they do represent a compilation of homes visited in about 100 different field studies, some of which involved random sampling. In each study, the house volumes were directly measured or estimated. The collective homes visited in these field projects are not geographically balanced; a large fraction of these homes are located in southern California. Statistical weighting techniques were applied in developing estimates of nationwide distributions (see Section 17.3.2) to compensate for the geographic imbalance.

*U.S. DOE (1995) - Housing Characteristics 1993, Residential Energy Consumption Survey (RECS)* - Measurement surveys have not been conducted to directly characterize the range and distribution of volumes for a random sample of U.S. residences. Related data, however, are regularly collected through the U.S. DOE's RECS (U.S. DOE, 1995). In addition to collecting information on energy use, this triennial survey collects data on housing characteristics including direct measurements of total and heated floor space for buildings visited by survey specialists. For the most recent survey (1993), a multistage probability sample of over 7,000 residences was surveyed, representing 96 million residences nationwide. The survey response rate was 81.2 percent. Volumes were estimated from the RECS measurements by multiplying the heated floor space area by an assumed ceiling height of 8 feet, recognizing that this assumed height may not apply universally to all homes.

Results for residential volume distributions from the RECS (Thompson, 1995) are presented in Table 17-1. Estimated parameters of residential volume distributions (in cubic meters) from the PFT database (Versar, 1990) are also summarized in Table 17-1, for comparison to the RECS data. The arithmetic means from the two sources are identical (369 cubic meters). The medians (50th percentiles) are very similar: 310 cubic meters for the RECS data, and 321 cubic meters for the PFT database.





Chapter 17 - Residential Building Characteristics

Cumulative frequency distributions from the two sources (Figure 17-2) also are quite similar, especially between the 50th and 75th percentiles.

predominant housing type--single-family detached homes--also has the largest average volume (Table 17-2). Multifamily units and mobile homes have volumes averaging about half that of single-family detached homes, with single-family attached homes about halfway between these extremes. Within each category of housing type, owner-occupied residences average about 50 percent greater volume than rental units. The relationship of residential volume to household size (Table 17-3) is of particular interest for purposes of exposure assessment. For example, one-person households would not include children, and the data in the table indicate that multi-person households occupy residences averaging about 50 percent greater volume than residences occupied by one-person households.

Parameter	RECS Data (1)	PFT Database (2)
Arithmetic Mean	369	369
Standard Deviation	258	209
10th Percentile	147	167
25th Percentile	209	225
50th Percentile	310	321
75th Percentile	476	473
90th Percentile	672	575

<sup>a</sup> In cubic meters  
Sources: (1) Thompson, 1995; (2) Versar, 1990

The RECS also provides relationships between average residential floor areas and factors such as housing type, ownership, household size and structure age. The

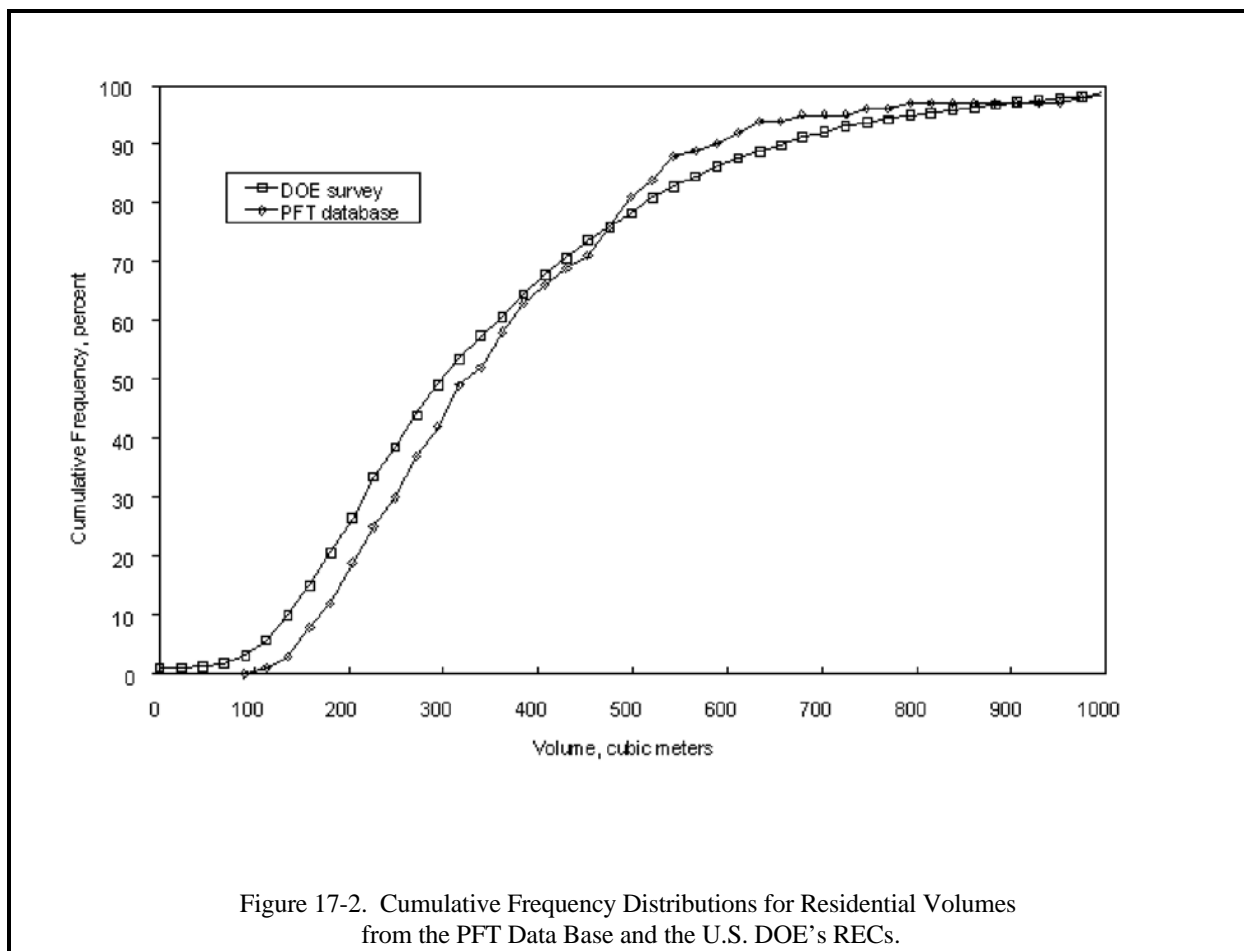

Figure 17-2. Cumulative Frequency Distributions for Residential Volumes from the PFT Data Base and the U.S. DOE's RECs.



Table 17-2. Average Estimated Volumes of U.S. Residences, by Housing Type and Ownership

Housing Type	Ownership					
	Owner-Occupied		Rental		All Units	
	Volume <sup>a</sup> (m <sup>3</sup> )	Percent of Total	Volume <sup>a</sup> (m <sup>3</sup> )	Percent of Total	Volume <sup>a</sup> (m <sup>3</sup> )	Percent of Total
Single-Family (Detached)	471	53.1	323	8.5	451	61.7
Single-Family (Attached)	406	4.6	291	2.9	362	7.5
Multifamily (2-4 units)	362	1.6	216	6.7	243	8.3
Multifamily (5+ Units)	241	1.7	183	15.2	190	16.8
Mobile Home	221	4.6	170	1.2	210	5.8
All Types	441	65.4	233	34.6	369	100.0

<sup>a</sup> Volumes calculated from floor areas assuming a ceiling height of 8 feet.  
Source: Adapted from U.S. DOE, 1995.

Table 17-3. Residential Volumes in Relation to Household Size and Year of Construction

	Volume <sup>a</sup> (m <sup>3</sup> )	Percent of Total
<u>Household Size</u>		
1 Person	269	24.3
2 Persons	386	32.8
3 Persons	387	17.2
4 Persons	431	15.1
5 Persons	433	7.0
6 or More Persons	408	3.6
All Sizes	369	100.0
<u>Year of Construction</u>		
1939 or before	385	21.1
1940 to 1949	338	7.1
1950 to 1959	365	13.5
1960 to 1969	358	15.5
1970 to 1979	350	18.7
1980 to 1984	344	8.8
1985 to 1987	387	5.7
1988 to 1990	419	4.9
1991 to 1993	438	4.7
All Years	369	100.0

<sup>a</sup> Volumes calculated from floor areas assuming a ceiling height of 8 feet.  
Source: U.S. DOE, 1995.

Data on year of construction indicate a slight decrease in residential volumes between 1950 and 1984, followed by an increasing trend over the next decade. A ceiling height of 8 feet was assumed in estimating the

average volumes, whereas there may have been some time-related trends in ceiling height.

*Murray (1996) - Analysis of RECS and PFT Databases.* Using a database from the 1993 RECS and an assumed ceiling height of 8 feet, Murray (1996) estimated a mean residential volume of 382 m<sup>3</sup> using RECS estimates of heated floor space. This estimate is slightly different from the mean of 369 m<sup>3</sup> given in Table 17-1. Murray's (1996) sensitivity analysis indicated that when a fixed ceiling height of 8 feet was replaced with a randomly varying height with a mean of 8 feet, there was little effect on the standard deviation of the estimated distribution. From a separate analysis of the PFT database, based on 1,751 individual household measurements, Murray (1996) estimated an average volume of 369 m<sup>3</sup>, the same as previously given in Table 17-1. In performing this analysis, the author carefully reviewed the PFT database in an effort to use each residence only once, for those residences thought to have multiple PFT measurements.

**17.2.2. Volumes and Surface Areas of Rooms**

*Room Volumes* - Volumes of individual rooms are dependent on the building size and configuration, but summary data are not readily available. The exposure assessor is advised to define specific rooms, or assemblies of rooms, that best fit the scenario of interest. Most models for predicting indoor-air concentrations specify airflows in



cubic meters per hour and, correspondingly, express volumes in cubic meters. A measurement in cubic feet can be converted to cubic meters by multiplying the value in cubic feet by 0.0283 m<sup>3</sup>/ft<sup>3</sup>. For example, a bedroom that is 9 feet wide by 12 feet long by 8 feet high has a volume of 864 cubic feet or 24.5 cubic meters. Similarly, a living room with dimensions of 12 feet wide by 20 feet long by 8 feet high has a volume of 1920 cubic feet or 54.3 cubic meters, and a bathroom with dimensions of 5 feet by 12 feet by 8 feet has a volume of 480 cubic feet or 13.6 cubic meters.

Murray (1996) analyzed the distribution of selected residential zones (i.e., a series of connected rooms) using the PFT database. The author analyzed the "kitchen zone" and the "bedroom zone" for houses in the Los Angeles area that were labeled in this manner by field researchers, and "basement," "first floor," and "second floor" zones for houses outside of Los Angeles for which the researchers labeled individual floors as zones. The kitchen zone

surface area-to-volume, or loading ratio. Table 17-4 provides the basis for calculating loading ratios for typical-sized rooms. Constant features in the examples are: a room width of 12 feet and a ceiling height of 8 feet (typical for residential buildings), or a ceiling height 12 feet (typical for commercial buildings). The loading ratios for the 8-foot ceiling height range from 0.98 m<sup>2</sup>m<sup>-3</sup> to 2.18 m<sup>2</sup>m<sup>-3</sup> for wall area and from 0.36 m<sup>2</sup>m<sup>-3</sup> to 0.44 m<sup>2</sup>m<sup>-3</sup> for floor area. In comparison, ASTM Standard E 1333 (ASTM, 1990), for large-chamber testing of formaldehyde levels from wood products, specifies the following loading ratios: (1) 0.95 m<sup>2</sup>m<sup>-3</sup> for testing plywood (assumes plywood or paneling on all four walls of a typical size room); and (2) 0.43 m<sup>2</sup>m<sup>-3</sup> for testing particleboard (assumes that particleboard decking or underlayment would be used as a substrate for the entire floor of a structure).

*Products and Materials* - Table 17-5 presents examples of assumed amounts of selected products and materials used in constructing or finishing residential

Table 17-4. Dimensional Quantities for Residential Rooms

Nominal Dimensions	Length (m)	Width (m)	Height (m)	Volume (m <sup>3</sup> )	Wall Area (m <sup>2</sup> )	Floor Area (m <sup>2</sup> )	Total Area (m <sup>2</sup> )
Eight Foot Ceiling							
12'x15'	4.6	3.7	2.4	41	40	17	74
12'x12'	3.7	3.7	2.4	33	36	13	62
10'x12'	3.0	3.7	2.4	27	33	11	55
9'x12'	2.7	3.7	2.4	24	31	10	51
6'x12'	1.8	3.7	2.4	16	27	7	40
4'x12'	1.2	3.7	2.4	11	24	4	32
Twelve Foot Ceiling							
12'x15'	4.6	3.7	3.7	61	60	17	94
12'x12'	3.7	3.7	3.7	49	54	13	80
10'x12'	3.0	3.7	3.7	41	49	11	71
9'x12'	2.7	3.7	3.7	37	47	10	67
6'x12'	1.8	3.7	3.7	24	40	7	54
4'x12'	1.2	3.7	3.7	16	36	4	44

contained the kitchen in addition to any of the following associated spaces: utility room, dining room, living room and family room. The bedroom zone contained all the bedrooms plus any bathrooms and hallways associated with the bedrooms. The following summary statistics (mean ± standard deviation) were reported by Murray (1996) for the volumes of the zones described above: 199 ± 115 m<sup>3</sup> for the kitchen zone, 128 ± 67 m<sup>3</sup> for the bedroom zone, 205 ± 64 m<sup>3</sup> for the basement, 233 ± 72 m<sup>3</sup> for the first floor, and 233 ± 111 m<sup>3</sup> for the second floor.

*Surface Areas* - The surface areas of floors are commonly considered in relation to the room or house volume, and their relative loadings are expressed as a

surfaces (Tucker, 1991). Products used for floor surfaces include adhesive, varnish and wood stain; and materials used for walls include paneling, painted gypsum board, and wallpaper. Particleboard and chipboard are commonly used for interior furnishings such as shelves or cabinets, but could also be used for decking or underlayment. It should be noted that numbers presented in Table 17-5 for surface area are based on typical values for residences, and they are presented as examples. In contrast to the concept of loading ratios presented above (as a surface area), the numbers in Table 17-5 also are not scaled to any particular residential volume. In some cases, it may be preferable for the exposure assessor to use professional judgment in



combination with the loading ratios given above. For example, if the exposure scenario involves residential carpeting, either as an indoor source or as an indoor sink, then the ASTM loading ratio of  $0.43 \text{ m}^2\text{m}^{-3}$  for floor materials could be multiplied by an assumed residential volume and assumed fractional coverage of carpeting to derive an estimate of the surface area. More specifically, a residence with a volume of  $300 \text{ m}^3$ , a loading ratio of  $0.43 \text{ m}^2\text{m}^{-3}$  and coverage of 80% would have  $103 \text{ m}^2$  of carpeting. The estimates discussed here relate to macroscopic surfaces; the true surface area for carpeting, for example, would be considerably larger because of the nature of its fibrous material.

Material Sources	Assumed Amount of Surface Covered <sup>a</sup>
Silicone caulk	0.2 m <sup>2</sup>
Floor adhesive	10.0 m <sup>2</sup>
Floor wax	50.0 m <sup>2</sup>
Wood stain	10.0 m <sup>2</sup>
Polyurethane wood finish	10.0 m <sup>2</sup>
Floor varnish or lacquer	50.0 m <sup>2</sup>
Plywood paneling	100.0 m <sup>2</sup>
Chipboard	100.0 m <sup>2</sup>
Gypsum board	100.0 m <sup>2</sup>
Wallpaper	100.0 m <sup>2</sup>

<sup>a</sup> Based on typical values for a residence.  
Source: Adapted from Tucker, 1991.

*Furnishings* Information on the relative abundance of specific types of indoor furnishings, such as draperies or upholstered furniture, was not readily available. The exposure assessor is advised to rely on common sense and professional judgment. For example, the number of beds in a residence is usually related to household size, and information has been provided (Table 17-3) on average house volume in relation to household size.

### 17.2.3. Mechanical System Configurations

Mechanical systems for air movement in residences can affect the migration and mixing of pollutants released indoors and the rate of pollutant removal. Three types of mechanical systems are: (1) systems associated with heating and air conditioning (HAC); (2) systems whose primary function is providing localized exhaust; and (3) systems intended to increase the overall air exchange rate of the residence.

Portable space heaters intended to serve a single room, or a series of adjacent rooms, may or may not be equipped with blowers that promote air movement and

mixing. Without a blower, these heaters still have the ability to induce mixing through convective heat transfer. If the heater is a source of combustion pollutants, as with unvented gas or kerosene space heaters, then the combination of convective heat transfer and thermal buoyancy of combustion products will result in fairly rapid dispersal of such pollutants. The pollutants will disperse throughout the floor where the heater is located and to floors above the heater, but will not disperse to floors below.

Central forced-air HAC systems are common in many residences. Such systems, through a network of supply/return ducts and registers, can achieve fairly complete mixing within 20 to 30 minutes (Koontz et al., 1988). The air handler for such systems is commonly equipped with a filter (see Figure 17-3) that can remove particle-phase contaminants. Further removal of particles, via deposition on various room surfaces (see Section 17.3.2), is accomplished through increased air movement when the air handler is operating.

Figure 17-3 also distinguishes forced-air HAC systems by the return layout in relation to supply registers. The return layout shown in the upper portion of the figure is the type most commonly found in residential settings. On any floor of the residence, it is typical to find one or more supply registers to individual rooms, with one or two centralized return registers. With this layout, supply/return imbalances can often occur in individual rooms, particularly if the interior doors to rooms are closed. In comparison, the supply/return layout shown in the lower portion of the figure by design tends to achieve a balance in individual rooms or zones. Airflow imbalances can also be caused by inadvertent duct leakage to unconditioned spaces such as attics, basements, and crawl spaces. Such imbalances usually depressurize the house, thereby increasing the likelihood of contaminant entry via soil-gas transport or through spillage of combustion products from vented fossil-fuel appliances such as fireplaces and gas/oil furnaces.

Mechanical devices such as kitchen fans, bathroom fans, and clothes dryers are intended primarily to provide localized removal of unwanted heat, moisture, or odors. Operation of these devices tends to increase the air exchange rate between the indoors and outdoors. Because

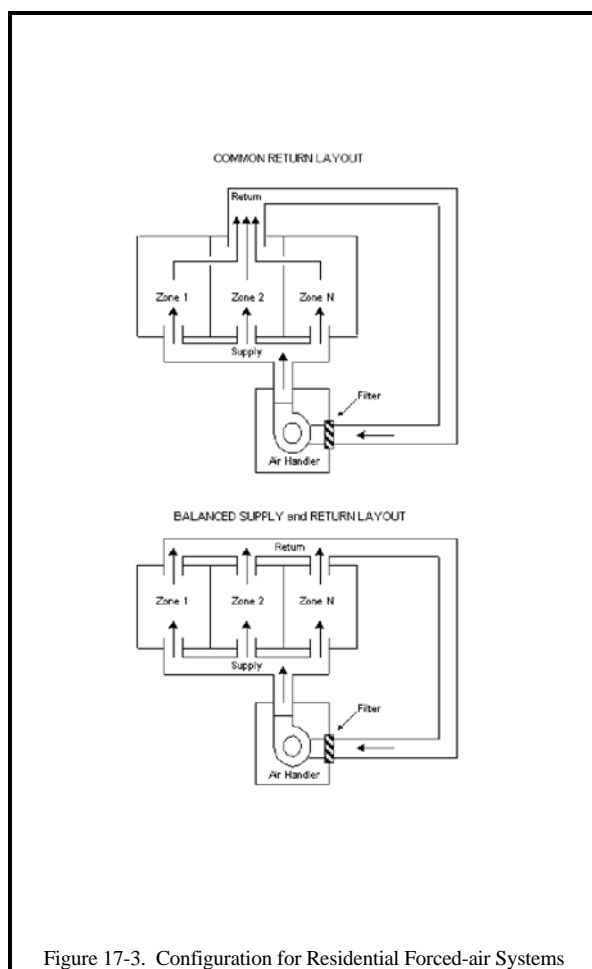

local exhaust devices are designed to be near certain indoor sources, their effective removal rate for locally generated pollutants is greater than would be expected from the dilution effect of increased air exchange. Operation of these devices also tends to depressurize the house, because replacement air usually is not provided to balance the exhausted air.

An alternative approach to pollutant removal is one which relies on an increase in air exchange to dilute pollutants generated indoors. This approach can be accomplished using heat recovery ventilators (HRVs) or energy recovery ventilators (ERVs). Both types of ventilators are designed to provide balanced supply and exhaust airflows and are intended to recover most of the energy that normally is lost when additional outdoor air is introduced. Although ventilators can provide for more

rapid dilution of internally generated pollutants, they also increase the rate at which outdoor pollutants are brought into the house. A distinguishing feature of the two types is that ERVs provide for recovery of latent heat (moisture) in addition to sensible heat. Moreover, ERVs typically recover latent heat using a moisture-transfer device such as a desiccant wheel. It has been observed in some studies that the transfer of moisture between outbound and inbound air streams can result in some re-entrainment of indoor pollutants that otherwise would have been exhausted from the house (Andersson et al., 1993). Inadvertent air communication between the supply and exhaust air streams can have a similar effect.

Studies quantifying the effect of mechanical devices on air exchange using tracer-gas measurements are uncommon and typically provide only anecdotal data. The common approach is for the expected increment in the air exchange rate to be estimated from the rated airflow capacity of the device(s). For example, if a device with a rated capacity of 100 cubic feet per minute (cfm), or 170 cubic meters per hour, is operated continuously in a house with a volume of 400 cubic meters, then the expected increment in the air exchange rate of the house would be  $170 \text{ m}^3 \text{ h}^{-1} / 400 \text{ m}^3$ , or approximately 0.4 air changes per hour.

#### 17.2.4. Type of Foundation

The type of foundation of a residence is of interest in residential exposure assessment. It provides some indication of the number of stories and house configuration, and provides an indication of the relative potential for soil-gas transport. For example, such transport can occur readily in homes with enclosed crawl spaces. Homes with basements provide some resistance, but still have numerous pathways for soil-gas entry. By comparison, homes with crawl spaces open to the outside have significant opportunities for dilution of soil gases prior to transport into the house.

*Lucas et al. (1992) - National Residential Radon Survey - The National Residential Radon Survey, sponsored by the U.S. EPA, was conducted by Lucas et al. (1992) in about 5,700 households nationwide. In addition to radon measurements, information on a number of housing characteristics was collected, including whether each house had a basement. The estimated percentage (45.2 percent) of homes in the U.S. having basements (Table 17-6) from this survey is the same as found by the RECS (Table 17-7).*



Table 17-6. Percent of Residences with Basement, by Census Region and EPA Region

Census Region	EPA Region	Percent of Residences with Basements
Northeast	1	93.4
Northeast	2	55.9
Northeast	3	67.9
South	4	19.3
Midwest	5	73.5
South	6	4.1
Midwest	7	75.3
West	8	68.5
West	9	10.3
West	10	11.5
	All Regions	45.2

Source: Lucas et al., 1992.

The National Residential Radon Survey provides data for more refined geographical areas, with a breakdown by the 10 EPA Regions. The New England region (i.e., EPA Region 1), which includes Connecticut, Maine, Massachusetts, New Hampshire, Rhode Island, and Vermont, had the highest prevalence of basements (93 percent). The lowest prevalence (4 percent) was for the South Central region (i.e., EPA Region 6), which includes Arkansas, Louisiana, New Mexico, Oklahoma, and Texas. Table 17-8 presents the States associated with each Census Region and EPA Region.

*U.S. DOE (1995) - Housing Characteristics 1993 - Residential Energy Consumption Survey (RECS)* - The most recent RECS (described in Section 17.2.1) was administered in 1993 to over 7,000 households (U.S. DOE, 1995). The type of information requested by the survey questionnaire included the type of foundation for the residence (i.e., basement, enclosed crawl space, crawl space open to outside or concrete slab). This information was not obtained for multifamily structures with five or more dwelling units or for mobile homes. Table 17-7 presents estimates from the survey of the percentage of residences with each foundation type, by census region, and for the entire U.S. The percentages can add to more than 100 percent because some residences have more than one type of foundation; for example, most split-level structures have a partial basement combined with some crawlspace that typically is enclosed.

The data in Table 17-7 indicate that close to half (45 percent) of residences nationwide have a basement, and that fewer than 10 percent have a crawl space that is open to outside. It also shows that a large fraction of homes have concrete slabs (31 percent). There are also variations by census region. For example, nearly 80 percent of the residences in the Northeast and Midwest regions have

basements. In the South and West regions, the predominant foundation types are concrete slabs and enclosed crawl spaces. Table 17-8 illustrates the four Census Regions.

### 17.3. TRANSPORT RATES

#### 17.3.1. Background

Major air transport pathways for airborne substances in residences include the following:

- Air exchange - Air leakage through windows, doorways, intakes and exhausts, and “adventitious openings” (i.e., cracks and seams) that combine to form the leakage configuration of the building envelope plus natural and mechanical ventilation;
- Interzonal airflows - Transport through doorways, ductwork, and service chaseways that interconnect rooms or zones within a building; and
- Local circulation - Convective and advective air circulation and mixing within a room or within a zone.

The distribution of airflows across the building envelope that contribute to air exchange and the interzonal airflows along interior flowpaths is determined by the interior pressure distribution. The forces causing the airflows are temperature differences, the actions of wind, and mechanical ventilation systems. Basic concepts have been reviewed by ASHRAE (1993). Indoor-outdoor and room-to-room temperature differences create density differences that help determine basic patterns of air motion. During the heating season, warmer indoor air tends to rise to exit the building at upper levels by stack action. Exiting air is replaced at lower levels by an influx of colder outdoor air. During the cooling season, this pattern is reversed: stack forces during the cooling season are generally not as strong as in the heating season because the indoor-outdoor temperature differences are not pronounced.

In examining a data base of air leakage measurements, Sherman and Dickerhoff (1996) observed that houses built prior to 1980 showed a clear increase in leakage with increasing age and were leakier, on average,



Chapter 17 - Residential Building Characteristics

Table 17-7. Percent of Residences with Certain Foundation Types by Census Region

Census Region	Percent of Residences <sup>a</sup>			
	With Basement	With Enclosed Crawlspace	With Crawlspace Open to Outside	With Concrete Slab
Northeast	78.0	12.6	2.8	15.8
Midwest	78.1	19.5	5.6	14.7
South	18.6	31.8	11.0	44.6
West	19.4	36.7	8.1	43.5
All Regions	45.2	26.0	7.5	31.3

<sup>a</sup> Percentage may add to more than 100 percent because more than one foundation type may apply to a given residence.  
Source: U.S. DOE, 1995.

Table 17-8. States Associated with EPA Regions and Census Regions

US EPA Regions			
<u>Region 1</u> Connecticut Maine Massachusetts New Hampshire Rhode Island Vermont	<u>Region 4</u> Alabama Florida Georgia Kentucky Mississippi North Carolina South Carolina Tennessee	<u>Region 6</u> Arkansas Louisiana New Mexico Oklahoma Texas	<u>Region 9</u> Arizona California Hawaii Nevada
<u>Region 2</u> New Jersey New York	<u>Region 5</u> Illinois Indiana Michigan Minnesota Ohio Wisconsin	<u>Region 7</u> Iowa Kansas Missouri Nebraska	<u>Region 10</u> Alaska Idaho Oregon Washington
<u>Region 3</u> Delaware District of Columbia Maryland Pennsylvania Virginia West Virginia		<u>Region 8</u> Colorado Montana North Dakota South Dakota Utah Wyoming	
US Bureau of Census Regions			
<u>Northeast Region</u> Connecticut Maine Massachusetts New Hampshire New Jersey New York Pennsylvania Rhode Island Vermont	<u>Midwest Region</u> Illinois Indiana Iowa Kansas Michigan Minnesota Missouri Nebraska North Dakota Ohio South Dakota Wisconsin	<u>South Region</u> Alabama Arkansas Delaware District of Columbia Florida Georgia Kentucky Louisiana Maryland Mississippi North Carolina Oklahoma South Carolina Tennessee Texas Virginia West Virginia	<u>West Region</u> Alaska Arizona California Colorado Hawaii Idaho Montana Nevada New Mexico Oregon Utah Washington Wyoming



than newer houses. They further observed that the post-1980 houses did not show any trend in leakiness with age.

The position of the neutral pressure level (i.e., the point where indoor-outdoor pressures are equal) depends on the leakage configuration of the building envelope. The stack effect arising from indoor-outdoor temperature differences is also influenced by the partitioning of the building interior. When there is free communication between floors or stories, the building behaves as a single volume affected by a generally rising current during the heating season and a generally falling current during the cooling season. When vertical communication is restricted, each level essentially becomes an independent zone. As the wind flows past a building, regions of positive and negative pressure (relative to indoors) are created within the building; positive pressures induce an influx of air, whereas negative pressures induce an outflow. Wind effects and stack effects combine to determine a net inflow or outflow.

The final element of indoor transport involves the actions of mechanical ventilation systems that circulate indoor air through the use of fans. Mechanical ventilation systems may be connected to heating/cooling systems that, depending on the type of building, recirculate thermally treated indoor air or a mixture of fresh air and recirculated air. Mechanical systems also may be solely dedicated to exhausting air from a designated area, as with some kitchen range hoods and bath exhausts, or to recirculating air in designated areas as with a room fan. Local air circulation also is influenced by the movement of people and the operation of local heat sources.

### 17.3.2. Air Exchange Rates

Air exchange is the balanced flow into and out of a building, and is composed of three processes: (1) infiltration - air leakage through random cracks, interstices, and other unintentional openings in the building envelope; (2) natural ventilation - airflows through open windows, doors, and other designed openings in the building envelope; and (3) forced or mechanical ventilation - controlled air movement driven by fans. For nearly all indoor exposure scenarios, air exchange is treated as the principal means of diluting indoor concentrations. The air exchange rate is generally expressed in terms of air changes per hour (ACH, with units of  $\text{h}^{-1}$ ), the ratio of the airflow ( $\text{m}^3 \text{h}^{-1}$ ) to the volume ( $\text{m}^3$ ).

No measurement surveys have been conducted to directly evaluate the range and distribution of residential air exchange rates. Although a significant number of air exchange measurements have been carried out over the

years, there has been a diversity of protocols and study objectives. Since the early 1980s, however, an inexpensive perfluorocarbon tracer (PFT) technique has been used to measure time-averaged air exchange and interzonal airflows in thousands of occupied residences using essentially similar protocols (Dietz et al., 1986). The PFT technique utilizes miniature permeation tubes as tracer emitters and passive samplers to collect the tracers. The passive samplers are returned to the laboratory for analysis by gas chromatography. These measurement results have been compiled to allow various researchers to access the data (Versar, 1990).

*Nazaroff et al. (1988)* - Prior to the Koontz and Rector (1995) study, Nazaroff et al. (1988) aggregated the data from two studies conducted earlier using tracer-gas decay. At the time these studies were conducted, they were the largest U.S. studies to include air exchange measurements. The first (Grot and Clark, 1981) was conducted in 255 dwellings occupied by low-income families in 14 different cities. The geometric mean  $\pm$  standard deviation for the air exchange measurements in these homes, with a median house age of 45 years, was  $0.90 \pm 2.13$  ACH. The second study (Grimsrud et al., 1983) involved 312 newer residences, with a median age of less than 10 years. Based on measurements taken during the heating season, the geometric mean  $\pm$  standard deviation for these homes was  $0.53 \pm 1.71$  ACH. Based on an aggregation of the two distributions with proportional weighting by the respective number of houses studied, Nazaroff et al. (1988) developed an overall distribution with a geometric mean of 0.68 ACH and a geometric standard deviation of 2.01.

*Versar (1990) - Database of PFT Ventilation Measurements* - The residences included in the PFT database do not constitute a random sample across the United States. They represent a compilation of homes visited in the course of about 100 separate field-research projects by various organizations, some of which involved random sampling and some of which involved judgmental or fortuitous sampling. The larger projects in the PFT database are summarized in Table 17-9, in terms of the number of measurements (samples), states where, and months when, samples were taken, and summary statistics for their respective distributions of measured air exchange rates. For selected projects (LBL, RTI, SOCAL), multiple measurements were taken for the same house, usually during different seasons. A large majority of the





Table 17-9. Summary of Major Projects Providing Air Exchange Measurements in the PFT Database

Project Code	State	Month(s) <sup>a</sup>	Number of Measurements	Mean Air Exchange Rate	SD <sup>b</sup>	Percentiles				
						10th	25th	50th	75th	90th
ADM	CA	5-7	29	0.70	0.52	0.29	0.36	0.48	0.81	1.75
BSG	CA	1,8-12	40	0.53	0.30	0.21	0.30	0.40	0.70	0.90
GSS	AZ	1-3,8-9	25	0.39	0.21	0.16	0.23	0.33	0.49	0.77
FLEMING	NY	1-6,8-12	56	0.24	0.28	0.05	0.12	0.22	0.29	0.37
GEOMET1	FL	1,6-8,10-12	18	0.31	0.16	0.15	0.18	0.25	0.48	0.60
GEOMET2	MD	1-6	23	0.59	0.34	0.12	0.29	0.65	0.83	0.92
GEOMET3	TX	1-3	42	0.87	0.59	0.33	0.51	0.71	1.09	1.58
LAMBERT1	ID	2-3,10-11	36	0.25	0.13	0.10	0.17	0.23	0.33	0.49
LAMBERT2	MT	1-3,11	51	0.23	0.15	0.10	0.14	0.19	0.26	0.38
LAMBERT3	OR	1-3,10-12	83	0.46	0.40	0.19	0.26	0.38	0.56	0.80
LAMBERT4	WA	1-3,10-12	114	0.30	0.15	0.14	0.20	0.30	0.39	0.50
LBL1	OR	1-4,10-12	126	0.56	0.37	0.28	0.35	0.45	0.60	1.02
LBL2	WA	1-4,10-12	71	0.36	0.19	0.18	0.25	0.32	0.42	0.52
LBL3	ID	1-5,11-12	23	1.03	0.47	0.37	0.73	0.99	1.34	1.76
LBL4	WA	1-4,11-12	29	0.39	0.27	0.14	0.18	0.36	0.47	0.63
LBL5	WA	2-4	21	0.36	0.21	0.13	0.19	0.30	0.47	0.62
LBL6	ID	3-4	19	0.28	0.14	0.11	0.17	0.26	0.38	0.55
NAHB	MN	1-5,9-12	28	0.22	0.11	0.11	0.16	0.20	0.24	0.38
NYSDH	NY	1-2,4,12	74	0.59	0.37	0.28	0.37	0.50	0.68	1.07
PEI	MD	3-4	140	0.59	0.45	0.15	0.26	0.49	0.83	1.20
PIERCE	CT	1-3	25	0.80	1.14	0.20	0.22	0.38	0.77	2.35
RTI1	CA	2	45	0.90	0.73	0.38	0.48	0.78	1.08	1.52
RTI2	CA	7	41	2.77	2.12	0.79	1.18	2.31	3.59	5.89
RTI3	NY	1-4	397	0.55	0.37	0.26	0.33	0.44	0.63	0.94
SOCAL1	CA	3	551	0.81	0.66	0.29	0.44	0.66	0.94	1.43
SOCAL2	CA	7	408	1.51	1.48	0.35	0.59	1.08	1.90	3.11
SOCAL3	CA	1	330	0.76	1.76	0.26	0.37	0.48	0.75	1.11
UMINN	MN	1-4	35	0.36	0.32	0.17	0.20	0.28	0.40	0.56
UWISC	WI	2-5	57	0.82	0.76	0.22	0.33	0.55	1.04	1.87

<sup>a</sup> 1 = January, 2 = February, etc.  
<sup>b</sup> Standard deviation  
Source: Adapted from Versar, 1990.

measurements are from the SOCAL project that was conducted in Southern California. The means of the respective studies generally range from 0.2 to 1.0 ACH, with the exception of two California projects--RTI2 and SOCAL2. Both projects involved measurements in Southern California during a time of year (July) when windows would likely be opened by many occupants.

*Koontz and Rector (1995) - Estimation of Distributions for Residential Air Exchange Rates* - In analyzing the composite data from various projects (2,971 measurements), Koontz and Rector (1995) assigned weights to the results from each state to compensate for the geographic imbalance in locations where PFT measurements were taken. The results were weighted in

such a way that the resultant number of cases would represent each state in proportion to its share of occupied housing units, as determined from the 1990 U.S. Census of Population and Housing.

Summary statistics from the Koontz and Rector (1995) analysis are shown in Table 17-10, for the country as a whole and by census regions. Based on the statistics for all regions combined, the authors suggested that a 10th percentile value of 0.18 ACH would be appropriate as a conservative estimator for air exchange in residential settings, and that the 50th percentile value of 0.45 ACH would be appropriate as a typical air exchange rate. In applying conservative or typical values of air exchange rates, it is important to realize the limitations of the



Chapter 17 - Residential Building Characteristics

underlying data base. Although the estimates are based on thousands of measurements, the residences represented in the database are not a random sample of the United States housing stock. The sample population is not balanced in terms of geography or time of year. Statistical techniques were applied to compensate for some of these imbalances. In addition, PFT measurements of air exchange rates assume uniform mixing of the tracer within the building. This is not always so easily achieved. Furthermore, the degree of mixing can vary from day to day and house to house because of the nature of the factors controlling mixing (e.g., convective air monitoring driven by weather, and type and operation of the heating system). The relative placement of the PFT source and the sampler can also cause variability and uncertainty. It should be noted that sampling is typically done in a single location in a house which may not represent the average from that house. In addition, very high and very low values of air exchange rates based on PFT measurements have greater uncertainties than those in the middle of the distribution. Despite such limitations, the estimates in Table 17-10 are believed to represent the best available information on the distribution of air exchange rates across United States residences throughout the year.

Murray and Burmaster (1995) - Residential Air Exchange Rates in the United States: Empirical and Estimated Parametric Distributions by Season and

and February were defined as winter, March, April and May were defined as spring, and so on. The results of Murray and Burmaster (1995) are summarized in Table 17-11. Neglecting the summer results in the colder regions which have only a few observations, the results indicate that the highest air exchange rates occur in the warmest climate region during the summer. As noted earlier (Section 17.3.2), many of the measurements in the warmer climate region were from field studies conducted in Southern California during a time of year (July) when windows would tend to be open in that area. Data for this region in particular should be used with caution since other areas within this region tend to have very hot summers and residences use air conditioners, resulting in lower air exchange rates. The lowest rates generally occur in the colder regions during the fall (Table 17-11).

17.3.3. Infiltration Models

A variety of mathematical models exist for prediction of air infiltration rates in individual buildings. A number of these models have been reviewed, for example, by Liddament and Allen (1983), and by Persily and Linteris (1984). Basic principles are concisely summarized in the ASHRAE Handbook of Fundamentals (ASHRAE, 1993). These models have a similar theoretical basis; all address indoor-outdoor pressure differences that are maintained by

Table 17-10. Summary Statistics for Air Exchange Rates (air changes per hour-ACH), by Region

	West Region	North Central Region	Northeast Region	South Region	All Regions
Arithmetic Mean	0.66	0.57	0.71	0.61	0.63
Arithmetic Standard Deviation	0.87	0.63	0.60	0.51	0.65
Geometric Mean	0.47	0.39	0.54	0.46	0.46
Geometric Standard Deviation	2.11	2.36	2.14	2.28	2.25
10th Percentile	0.20	0.16	0.23	0.16	0.18
50th Percentile	0.43	0.35	0.49	0.49	0.45
90th Percentile	1.25	1.49	1.33	1.21	1.26
Maximum	23.32	4.52	5.49	3.44	23.32

Source: Koontz and Rector, 1995.

Climatic Region - Murray and Burmaster (1995) analyzed the PFT database using 2,844 measurements (essentially the same cases as analyzed by Koontz and Rector (1995), but without the compensating weights). These authors summarized distributions for subsets of the data defined by climate region and season. The coldest region was defined as having 7,000 or more heating degree days, the colder region as 5,500-6,999 degree days, the warmer region as 2,500-5,499 degree days, and the warmest region as fewer than 2,500 degree days. The months of December, January

the actions of wind and stack (temperature difference) effects. The models generally incorporate a network of airflows where nodes representing regions of different pressure are interconnected by leakage paths. Individual models differ in details such as the number of nodes they



Table 17-11. Distributions of Residential Air Exchange Rates\* by Climate Region and Season

Climate Region	Season	Sample Size	Arithmetic Mean	Standard Deviation	Percentiles				
					10th	25th	50th	75th	90th
Coldest	Winter	161	0.36	0.28	0.11	0.18	0.27	0.48	0.71
	Spring	254	0.44	0.31	0.18	0.24	0.36	0.53	0.80
	Summer	5	0.82	0.69	0.27	0.41	0.57	1.08	2.01
	Fall	47	0.25	0.12	0.10	0.15	0.22	0.34	0.42
Colder	Winter	428	0.57	0.43	0.21	0.30	0.42	0.69	1.18
	Spring	43	0.52	0.91	0.13	0.21	0.24	0.39	0.83
	Summer	2	1.31	--	--	--	--	--	--
	Fall	23	0.35	0.18	0.15	0.22	0.33	0.41	0.59
Warmer	Winter	96	0.47	0.40	0.19	0.26	0.39	0.58	0.78
	Spring	165	0.59	0.43	0.18	0.28	0.48	0.82	1.11
	Summer	34	0.68	0.50	0.27	0.36	0.51	0.83	1.30
	Fall	37	0.51	0.25	0.30	0.30	0.44	0.60	0.82
Warmest	Winter	454	0.63	0.52	0.24	0.34	0.48	0.78	1.13
	Spring	589	0.77	0.62	0.28	0.42	0.63	0.92	1.42
	Summer	488	1.57	1.56	0.33	0.58	1.10	1.98	3.28
	Fall	18	0.72	1.43	0.22	0.25	0.42	0.46	0.74

\* In air changes per hour  
Source: Murray and Burmaster, 1995.

can treat or the specifics of leakage paths (e.g., individual components such as cracks around doors or windows versus a combination of components such as an entire section of a building). Such models are not easily applied by exposure assessors, however, because the required inputs (e.g., inferred leakage areas, crack lengths) for the model are not easy to gather.

Another approach for estimating air infiltration rates is developing empirical models. Such models generally rely on collection of infiltration measurements in a specific building under a variety of weather conditions. The relationship between the infiltration rate and weather conditions can then be estimated through regression analysis, and is usually stated in the following form:

$$A = a + b |T_i - T_o| + cU^n \quad (\text{Eqn. 17-1})$$

where:

- A = air infiltration rate (h<sup>-1</sup>)
- T<sub>i</sub> = indoor temperature (°C)
- T<sub>o</sub> = outdoor temperature (°C)
- U = windspeed (ms<sup>-1</sup>)

n is an exponent with a value typically between 1 and 2  
a, b and c are parameters to be estimated

Relatively good predictive accuracy usually can be obtained for individual buildings through this approach. However, exposure assessors often do not have the information resources required to develop parameter

estimates for making such predictions.

A reasonable compromise between the theoretical and empirical approaches has been developed in the model specified by Dietz et al. (1986). The model, drawn from correlation analysis of environmental measurements and air infiltration data, is formulated as follows:

$$A = L \left( 0.006\Delta T + \frac{0.03}{C} U^{1.5} \right) \quad (\text{Eqn. 17-2})$$

where:

- A = average air changes per hour or infiltration rate, h<sup>-1</sup>
- L = generalized house leakiness factor (1 < L < 5)
- C = terrain sheltering factor (1 < C < 10)
- ΔT = indoor-outdoor temperature difference (C°)
- U = windspeed (ms<sup>-1</sup>)

The value of L is greater as house leakiness increases and the value of C is greater as terrain sheltering (reflects shielding of nearby wind barrier) increases. Although the above model has not been extensively validated, it has intuitive appeal and it is possible for the user to develop reasonable estimates for L and C with limited guidance. Historical data from various U.S. airports are available for estimation of the temperature and windspeed parameters. As an example application, consider a house that has central values of 3 and 5 for L and C, respectively. Under conditions where the indoor temperature is 20 °C (68 °F), the outdoor temperature is 0 °C (32 ° F) and the windspeed is 5 ms<sup>-1</sup>, the predicted infiltration rate for that house would be 3 (0.006 x 20 + 0.03/5 x 51.5), or 0.56 air changes per



hour. This prediction applies under the condition that exterior doors and windows are closed, and does not include the contributions, if any, from mechanical systems (see Section 17.2.3). Occupant behavior, such as opening windows, can, of course, overwhelm the idealized effects of temperature and wind speed.

### 17.3.4. Deposition and Filtration

Deposition refers to the removal of airborne substances to available surfaces that occurs as a result of gravitational settling and diffusion, as well as electrophoresis and thermophoresis. Filtration is driven by similar processes, but is confined to material through which air passes. Filtration is usually a matter of design, whereas deposition is a matter of fact.

#### 17.3.4.1. Deposition

The deposition of particulate matter and reactive gas-phase pollutants to indoor surfaces is often stated in terms

air exchange. Theoretical considerations specific to indoor environments have been summarized in comprehensive reviews by Nazaroff and Cass (1989) and Nazaroff et al. (1993).

For airborne particles, deposition rates depend on aerosol properties (size, shape, density) as well as room factors (thermal gradients, turbulence, surface geometry). The motions of larger particles are dominated by gravitational settling; the motions of smaller particles are subject to convection and diffusion. Consequently, larger particles tend to accumulate more rapidly on floors and up-facing surfaces while smaller particles may accumulate on surfaces facing in any direction. Figure 17-4 illustrates the general trend for particle deposition across the size range of general concern for inhalation exposure ( $<10 \mu\text{m}$ ). The current thought is that theoretical calculations of deposition rates are likely to provide unsatisfactory results due to knowledge gaps relating to near-surface air motions and other sources of inhomogeneity (Nazaroff et al., 1993).

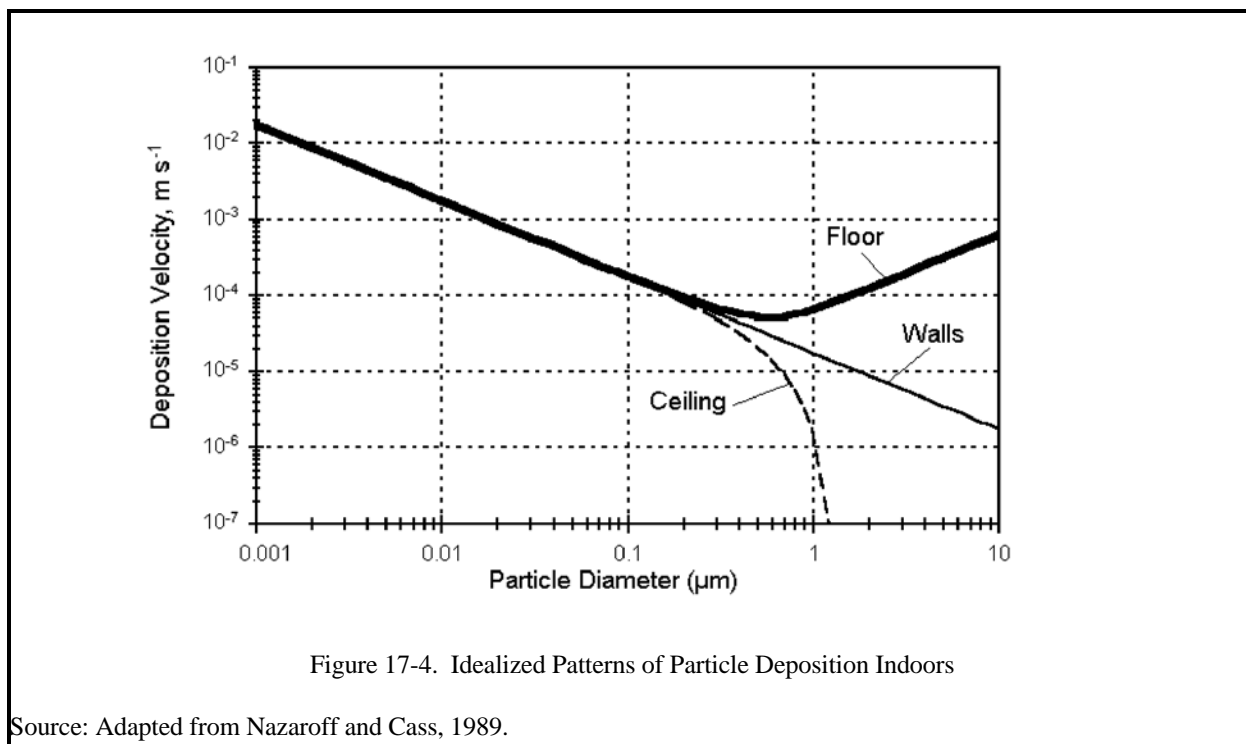

Figure 17-4. Idealized Patterns of Particle Deposition Indoors

Source: Adapted from Nazaroff and Cass, 1989.

of a characteristic deposition velocity ( $\text{m h}^{-1}$ ) allied to the surface-to-volume ratio ( $\text{m}^2 \text{m}^{-3}$ ) of the building or room interior, forming a first order loss rate ( $\text{h}^{-1}$ ) similar to that of

Wallace (1996) - *Indoor Particles: A Review* - In a major review of indoor particles, Wallace (1996) cited overall particle deposition rates for respirable ( $\text{PM}_{2.5}$ ),



inhalable (PM<sub>10</sub>), and coarse (difference between PM<sub>10</sub> and PM<sub>2.5</sub>) size fractions determined from EPA's PTEAM study. These values, listed in Table 17-12, were derived from measurements conducted in nearly 200 residences.

Size Fraction	Deposition Rate
PM <sub>2.5</sub>	0.39 h <sup>-1</sup>
PM <sub>10</sub>	0.65 h <sup>-1</sup>
Coarse	1.0 h <sup>-1</sup>

Source: Adapted from Wallace, 1996.

Thatcher and Layton (1995) - *Deposition, Resuspension, and Penetration of Particles Within a Residence* - Thatcher and Layton (1995) evaluated removal rates for indoor particles in four size ranges (1-5, 5-10, 10-25, and >25 μm) in a study of one house occupied by a family of four. These values are listed in Table 17-13. In a subsequent evaluation of data collected in 100 Dutch residences, Layton and Thatcher (1995) estimated settling velocities of 2.7 m h<sup>-1</sup> for lead-bearing particles captured in total suspended particulate matter (TSP) samples.

Particle Size Range	Particle Removal Rate (h <sup>-1</sup> )
1-5	0.5
5-10	1.4
10-25	2.4
>25	4.1

Source: Adapted from Thatcher and Layton, 1995.

#### 17.3.4.2. Filtration

A variety of air cleaning techniques have been applied to residential settings. Basic principles related to residential-scale air cleaning technologies have been summarized in conjunction with reporting early test results (Offerman et al., 1984). General engineering principles are summarized in ASHRAE (1988). In addition to fibrous filters integrated into central heating and air conditioning systems, extended surface filters and High Efficiency Particle Arrest (HEPA) filters as well as electrostatic systems are available to increase removal efficiency. Free-standing air cleaners (portable and/or console) are also being used. Product-by-product test results reported by Hanley et al. (1994); Shaughnessy et al. (1994); and Offerman et al. (1984) exhibit considerable variability across systems, ranging from ineffectual (< 1% efficiency) to nearly complete removal.

#### 17.3.5. Interzonal Airflows

Residential structures consist of a number of rooms that may be connected horizontally, vertically, or both horizontally and vertically. Before considering residential structures as a detailed network of rooms, it is convenient to divide them into one or more zones. At a minimum, each floor is typically defined as a separate zone. For indoor air exposure assessments, further divisions are sometimes made within a floor, depending on (1) locations of specific contaminant sources and (2) the presumed degree of air communication among areas with and without sources.

Defining the airflow balance for a multiple-zone exposure scenario rapidly increases the information requirements as rooms or zones are added. As shown in Figure 17-5, a single-zone system (considering the entire building as a single well-mixed volume) requires only two airflows to define air exchange. Further, because air exchange is balanced flow (air does not "pile up" in the building, nor is a vacuum formed), only one number (the air exchange rate) is needed. With two zones, six airflows are needed to accommodate interzonal airflows plus air exchange; with three zones, twelve airflows are required. In some cases, the complexity can be reduced using judicious (if not convenient) assumptions. Interzonal airflows connecting nonadjacent rooms can be set to zero, for example, if flow pathways do not exist. Symmetry also can be applied to the system by assuming that each flow pair is balanced.

#### 17.3.6. Water Uses

Among indoor water uses, showering, bathing and handwashing of dishes or clothes provide the primary opportunities for dermal exposure. Virtually all indoor water uses will result in some volatilization of chemicals, leading to inhalation exposure.

The exposure potential for a given situation will depend on the source of water, the types and extents of water uses, and the extent of volatilization of specific chemicals. According to the results of the 1987 Annual Housing Survey (U.S. Bureau of the Census, 1992), 84.7 percent of all U.S. housing units receive water from a public system or private company (as opposed to a well). Across the four major regions defined by the U.S. Census Bureau

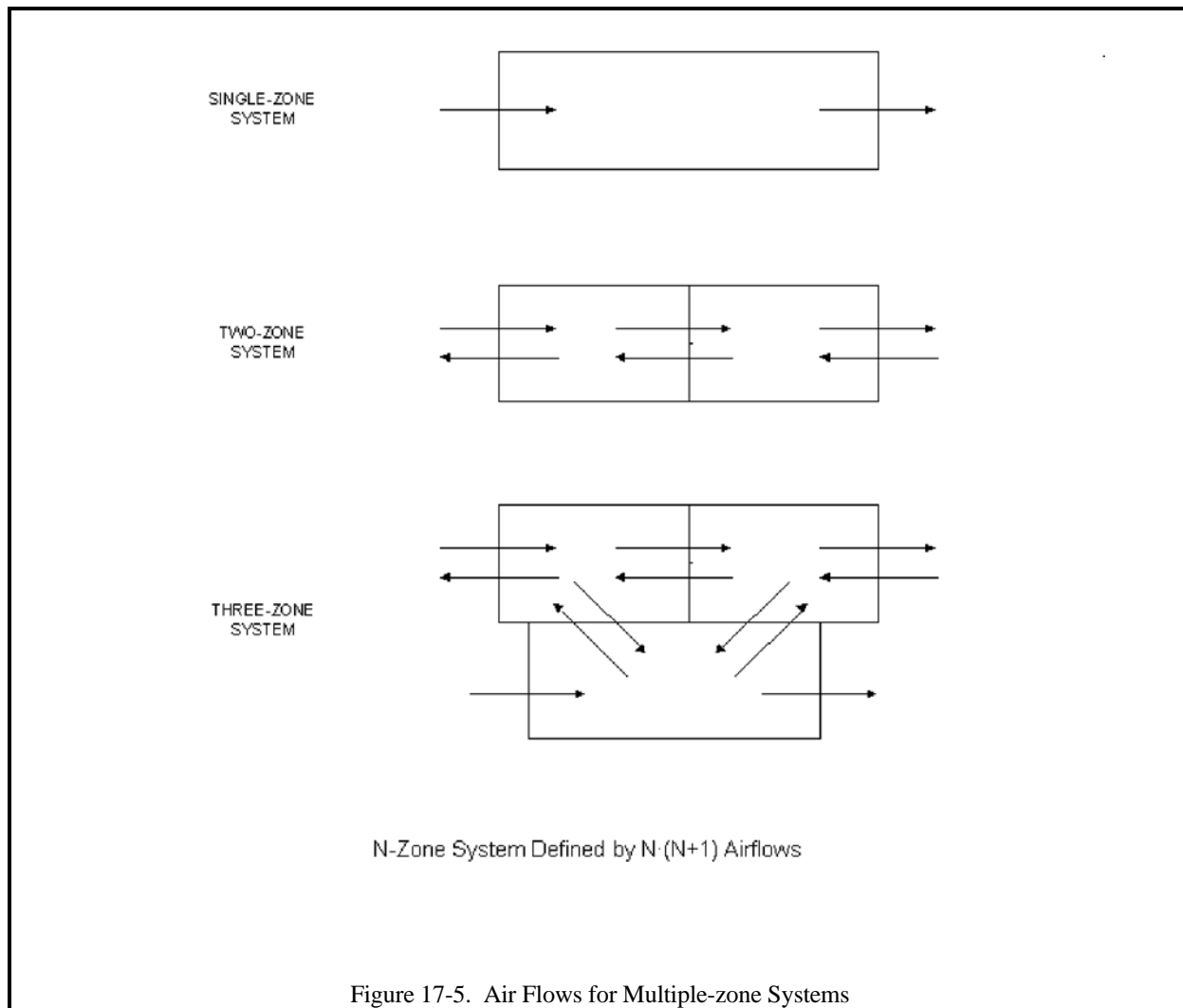

Figure 17-5. Air Flows for Multiple-zone Systems

(Northeast, South, Midwest, and West), the percentage varies from 82.5 in the Midwest region to 93.2 in the West region (the Northeast and South regions both are very close to the national percentage).

The primary types of water use indoors can be classified as showering/bathing, toilet use, clothes washing, dishwashing, and faucet use (e.g., for drinking, cooking, general cleaning, or washing hands). Substantial information on water use has been collected in California households by the Metropolitan Water District of Southern California (MWD, 1991) and by the East Bay Municipal Utility District (EBMUD, 1992). An earlier study by the U.S. Department of Housing and Urban Development (U.S. DHUD, 1984) monitored water use in 200 households over

a 20-month period. The household selection process for this study was not random; it involved volunteers from water companies and engineering organizations, most of which were located in large metropolitan areas. Nazaroff et al. (1988) also assembled the results of several smaller surveys, typically involving between 5 and 50 households each.

A common feature of the various studies cited above is that the results were all reported in gallons per capita per day (gcd), or in units that could be easily converted to gcd. Most studies also provided estimates by type of use--shower/bath, toilet, laundry, dishwashing, and other (e.g., faucets). A summary of the various study results is



Chapter 17 - Residential Building Characteristics

provided in Table 17-14. There is generally about a threefold variation across studies for total

Table 17-14. In-house Water Use Rates (gcd), by Study and Type of Use

Study	Total, All Uses	Shower or Bath	Toilet	Laundry	Dishwashing	Other
MWD <sup>1</sup>	93	26	30	20	5	12
EBMUD <sup>2</sup>	67	20	28	9	4	6
U.S. DHUD <sup>3</sup>	40	15	10	13	2	--
Nazaroff et al., 1988	52	6	17	11	18	--
Study 1						
Study 2						
- Rural	46	11	18	14	3	--
- Urban	43	10	18	11	4	--
Study 3	42	9	20	7	4	2
Study 4	45	9	15	11	4	6
Study 5	70	21	32	7	7	3
Study 6	59	20	24	8	4	3
Study 7	40	10	9	11	5	5
Study 8	52-86	20-40	4-6	20-30	8-10	--
Mean Across Studies <sup>5</sup>	59	17	18	13	6	5
Median Across Studies <sup>5</sup>	53	15	18	11	4	5

<sup>1</sup> Metropolitan Water District of Southern California, 1991.  
<sup>2</sup> East Bay Municipal Utility District, 1992.  
<sup>3</sup> U.S. Department of Housing and Urban Development, 1984.  
<sup>4</sup> Results of eight separate studies.  
<sup>5</sup> The average value from each range reported in Study No. 8 was used to calculate the median across studies. The mean and median for the "Total, all Uses" column were obtained by summing across the means and medians for individual types of water use.

in-house water use as well as each type of use. Central values for total use, were obtained by taking the mean and median across the studies for each type of water use and then summing these means/medians across uses. These central values are shown at the bottom of the table. The means and medians were summed across types of uses to obtain the mean for all uses combined because only a subset of the studies reported values for other uses.

The following sections provide a summary of the water use characteristics for the primary types of water uses indoors. To the extent found in the literature, each water use is described in terms of the frequency of use; flowrate during the use; quantity of water used during each occurrence of the water use; and quantity used by an average person. Table 17-15 summarizes the studies of U.S. DHUD and the Power Authorities by locations and number of households.

Table 17-15. Summary of Selected HUD and Power Authority Water Use Studies

	Number of Households	Location	Reference
<b>U.S. DHUD Studies</b>			
Study 1	37	Los Angeles, CA	a,b
Study 2	7	Sacramento, CA	a,c
Study 3	40	Walnut Creek, CA	a,c
Study 4	7	Washington, DC	a
Study 5	21	Sacramento, CA	a
Study 6	19	Los Angeles, CA	a
<b>Power Authority Studies</b>			
Study 1	32	Seattle, WA	a
Study 2	23	Denver, CO	a
Study 3	15	Aurora, CO	a
Study 4	10	Fairfax, VA	a
<b>TOTAL</b>	<b>211</b>		



Chapter 17 - Residential Building Characteristics

Sources:

- <sup>a</sup> U.S. Department of Housing and Urban Development, 1984.
- <sup>b</sup> Metropolitan Water District of Southern California, 1991.
- <sup>c</sup> East Bay Municipal Utility District, 1992.

Caution should be exercised when using the data collected in these studies and shown here. The participants in these studies are not a representative sample of the general population. The participants consisted of volunteers, mostly from large metropolitan areas.

*Showering and Bathing Water Use Characteristics* - The HUD study (U.S. DHUD, 1984) monitored 162 households for shower duration. The individuals were also subdivided by people who only shower or only bath. The results are given in Table 17-16. The flowrates of various types of shower heads were also evaluated in the study (Table 17-17).

*Toilet Water Use Characteristics* - The HUD study (U.S. DHUD, 1984) reported water volume per flush for various types of toilets and monitored 162 households for shower duration. The results of this study are shown in Table 17-18. Since the HUD study was conducted prior to 1984, the newer (post 1984) conserving toilets that are designed to use approximately 1.6 gallons per flush were not tested.

The frequency of use for toilets in households was examined in several studies (U.S. DHUD, 1984; Ligman, et al., 1974; Siegrist, 1976). The observed mean frequencies in these studies are given in Table 17-19. Tables 17-20 through 17-24 present indoor water use frequencies for dishwashers and clothes washers.

Table 17-16. Showering and Bathing Water Use Characteristics

Characteristic	Mean Duration	Mean Frequency
Individuals who Shower only	10.4 minutes/shower	0.74 showers/day/person
Individuals who Bath only	NA	0.41 baths/day/person
Individuals who Shower and Bath	NA	NA

Source: Adapted from U. S. DHUD, 1984.

Source: Adapted from U.S. DHUD, 1984.

Table 17-17. Showering Characteristics for Various Types of Shower Heads

Shower Head Type	Mean Flow Rate (gpm)
Non-Conserving (> 3 gpm)	3.4
Low Flow (≤ 3 gpm)	1.9
Restrictor (≤ 3 gpm)	2.1
Zinplas <sup>a</sup>	1.8
Turbojector <sup>a</sup>	1.3

<sup>a</sup> Types of low flow water fixtures.

Source: Adapted from U.S. DHUD, 1984.

Table 17-18. Toilet Water Use Characteristics

Toilet Type	Average Water Use (gallons/flush)
Non-Conserving	5.5
Bottles	5.0
Bags	4.8
Dams	4.5
Low-flush	3.5





Study	Flush Frequency (flushes/person/day)
U.S. DHUD, 1984 <sup>a</sup>	4.2 flushes/household/day
Ligman, et al., 1974 Rural, M-F	3.6 flushes/person/day
Ligman, et al., 1974 Rural, Sat-Sun	3.8 flushes/person/day
Ligman, et al., 1974 Urban, M-F	3.6 flushes/person/day
Ligman, et al., 1974 Urban, Sat-Sun	3.1 flushes/person/day
Siegrist, 1976	2.3 flushes/person/day
<b>Unweighted Mean</b>	<b>3.43 flushes/person/day</b>

<sup>a</sup> The HUD value may in fact be flushes/household/day

Study	Use Frequency
U.S. DHUD, 1984	0.47 loads/person/day
Ligman, et al., 1974 Rural	1.3 loads/day
Siegrist, 1976	0.39 loads/person/day
<b>Unweighted Mean</b>	<b>0.92 loads/day</b>

Brand	Average Water Use (gallons/regular cycle)	Cycle Duration (minutes)	
		140°F	120°F
Maytag	11.5	75	--
Frigidaire	12	75	75
General Electric	10.5	80	95
Sears	10	75	95
Whirlpool	9.5	60	110
White/Westinghouse	12	75	75
Waste King	11.5	65	85
Kitchen Aid	9.5	80	80
Magic Chef	11.5	70	--
<b>Unweighted Mean</b>	<b>10.9</b>	<b>72.8</b>	<b>87.9</b>

Source: Adapted from Consumer Reports, 1987.

Study	Use Frequency
U.S. DHUD, 1984	0.3 loads/person/day
Ligman, et al., 1974 Rural	0.34 loads/person/day
Ligman, et al., 1974 Urban	0.27 loads/person/day
Siegrist, 1976	0.31 loads/day

Brand	Average Water Use (gallons/regular cycle)	Cycle Duration (minutes)
Maytag	41	32
Frigidaire	48	40
General Electric	51	48
Hotpoint	51	48
Sears	49	40
Whirlpool	53	44
White/Westinghouse	54	47
Kelvinator	46	52
Norge	55	49

Source: Adapted from Consumer Reports, 1982.

Type of Clothes Washer	Range of Water Use
Conventional	27-59 gallons/load
Low Water	16-19 gallons/load
All Clothes Washers	16-59 gallons/load

Source: Adapted from Consumer Reports, 1982.

**17.3.7. House Dust and Soil**

House dust is a complex mixture of biologically-derived material (animal dander, fungal spores, etc.), particulate matter deposited from the indoor aerosol, and soil particles brought in by foot traffic. House dust may



contain VOCs (see, for example, Wolkoff and Wilkins, 1994; Hirvonen et al., 1995), pesticides from imported soil particles as well as from direct applications indoors (see, for example, Roberts et al., 1991), and trace metals derived from outdoor sources (see, for example, Layton and Thatcher, 1995). The indoor abundance of house dust depends on the interplay of deposition from the airborne state, resuspension due to various activities, direct accumulation, and infiltration.

In the absence of indoor sources, indoor concentrations of particulate matter are significantly lower than outdoor levels. For some time, this observation supported the idea that a significant fraction of the outdoor aerosol is filtered out by the building envelope. More recent data, however, have shown that deposition (incompletely addressed in earlier studies) accounts for the indoor-outdoor contrast, and outdoor particles smaller than 10  $\mu\text{m}$  aerodynamic diameter penetrate the building envelope as completely as nonreactive gases (Wallace, 1996).

*Roberts et al. (1991) - Development and Field Testing of a High Volume Sampler for Pesticides and Toxics in Dust* - Dust loadings, reported by Roberts et al. (1991) were also measured in conjunction with the Non-Occupational Pesticide Exposure Study (NOPES). In this study house dust was sampled from a representative grid using a specially constructed high-volume surface sampler (HVS2). The surface sampler collection efficiency was verified in conformance with ASTM F608 (ASTM, 1989). The data summarized in Table 17-25 were collected from carpeted areas in volunteer households in Florida encountered during the course of NOPES. Seven of the nine sites were single-family detached homes, and two were mobile homes. The authors noted that the two houses exhibiting the highest dust loadings were only those homes where a vacuum cleaner was not used for housekeeping.

Household	Total Dust Load (g-m <sup>2</sup> )	Fine Dust (<150 $\mu\text{m}$ ) Load (g-m <sup>2</sup> )
1	10.8	6.6
2	4.2	3.0
3	0.3	0.1
4	2.2; 0.8	1.2; 0.3
5	1.4; 4.3	1.0; 1.1
6	0.8	0.3
7	6.6	4.7
8	33.7	23.3
9	812.7	168.9

Source: Adapted from Roberts et al., 1991.

*Thatcher and Layton (1995) - Deposition, Resuspension and Penetration of Particles Within a*

*Residence* - Relatively few studies have been conducted at the level of detail needed to clarify the dynamics of indoor aerosols. One intensive study of a California residence (Thatcher and Layton, 1995), however, provides instructive results. Using a model-based analysis for data collected under controlled circumstances, the investigators verified penetration of the outdoor aerosol and estimated rates for particle deposition and resuspension (Table 17-26). The investigators stressed that normal household activities are a significant source of airborne particles larger than 5  $\mu\text{m}$ . During the study, they observed that just walking into and out of a room could momentarily double the concentration. The airborne abundance of submicrometer particles, on the other hand, was unaffected by either cleaning or walking.

Particle Size Range ( $\mu\text{m}$ )	Particle Deposition Rate (h <sup>-1</sup> )	Particle Resuspension Rate (h <sup>-1</sup> )
0.3-0.5	(not measured)	9.9 x 10 <sup>-7</sup>
0.6-1	(not measured)	4.4 x 10 <sup>-7</sup>
1-5	0.5	1.8 x 10 <sup>-5</sup>
5-10	1.4	8.3 x 10 <sup>-5</sup>
10-25	2.4	3.8 x 10 <sup>-4</sup>
>25	4.1	3.4 x 10 <sup>-5</sup>

Source: Adapted from Thatcher and Layton, 1995.

Mass loading of floor surfaces (Table 17-27) was measured in the study of Thatcher and Layton (1995) by thoroughly cleaning the house and sampling accumulated dust, after one week of normal habitation. Methodology, validated under ASTM F608 (ASTM, 1989), showed fine dust recovery efficiencies of 50 percent with new carpet and 72 percent for linoleum. Tracked areas showed consistently higher accumulations than untracked areas, confirming the importance of tracked-in material. Differences between tracked areas upstairs and downstairs show that tracked-in material is not readily transported upstairs. The consistency of untracked carpeted areas throughout the house, suggests that, in the absence of tracking, particle transport processes are similar on both floors.



Location in Test House	Dust Loading (g-m <sup>-2</sup> )
Tracked area of downstairs carpet	2.20
Untracked area of downstairs carpet	0.58
Tracked area of linoleum	0.08
Untracked area of linoleum	0.06
Tracked area of upstairs carpet	1.08
Untracked area of upstairs carpet	0.60
Front doormat	43.34

Source: Adapted from Thatcher and Layton, 1995.

### 17.4. SOURCES

Product- and chemical-specific mechanisms for indoor sources can be described using simple emission factors to represent instantaneous releases, as well as constant releases over defined time periods; more complex formulations may be required for time-varying sources. Guidance documents for characterizing indoor sources within the context of the exposure assessment process are limited (see, for example, Jennings et al., 1987; Wolkoff, 1995). Fairly extensive guidance exists in the technical literature, however, provided that the exposure assessor has the means to define (or estimate) key mechanisms and chemical-specific parameters. Basic concepts are summarized below for the broad source categories that relate to airborne contaminants, waterborne contaminants, and for soil/house dust indoor sources.

#### 17.4.1. Source Descriptions for Airborne Contaminants

Table 17-28 summarizes simplified indoor source descriptions for airborne chemicals for direct discharge sources (e.g., combustion, pressurized propellant products), as well as emanation sources (e.g., evaporation from “wet” films, diffusion from porous media), and transport-related sources (e.g., infiltration of outdoor air contaminants, soil gas entry).

Direct-discharge sources can be approximated using simple formulas that relate pollutant mass released to characteristic process rates. Combustion sources, for example, may be stated in terms of an emission factor, fuel content (or heating value), and fuel consumption (or carrier delivery) rate. Emission factors for combustion products of general concern (e.g., CO, NO<sub>x</sub>) have been measured for a number of combustion appliances using room-sized chambers (see, for example, Relwani et al., 1986). Other direct-discharge sources would include volatiles released from water use and from pressurized consumer products. Resuspension of house dust (see Section 17.3.7) would take

on a similar form by combining an activity-specific rate constant with an applicable dust mass.

Description	Components	Dimensions
Direct Discharge		
Combustion	$E_f H_f M_f$ $E_f$ = emission factor $H_f$ = fuel content $M_f$ = fuel consumption rate	$g h^{-1}$ $g J^{-1}$ $J mol^{-1}$ $mol h^{-1}$
Volume Discharge	$Q_p C_p \epsilon$ $Q_p$ = volume delivery rate $C_p$ = concentration in carrier $\epsilon$ = transfer efficiency	$g h^{-1}$ $m^3 h^{-1}$ $g m^{-3}$ $g g^{-1}$
Mass Discharge	$M_p w_e \epsilon$ $M_p$ = mass delivery rate $w_e$ = weight fraction $\epsilon$ = transfer efficiency	$g h^{-1}$ $g h^{-1}$ $g g^{-1}$ $g g^{-1}$
Diffusion Limited	$(D_f \delta^{-1})(C_s - C_i)A_i$ $D_f$ = diffusivity $\delta^{-1}$ = boundary layer thickness $C_s$ = vapor pressure of surface $C_i$ = room concentration $A_i$ = area	$g h^{-1}$ $m^2 h^{-1}$ $m$ $g m^{-3}$ $g m^{-3}$ $m^2$
Exponential	$A_i E_o e^{-kt}$ $A_i$ = area $E_o$ = initial unit emission rate $k$ = emission decay factor $t$ = time	$g h^{-1}$ $m^2$ $g h^{-1} m^{-2}$ $h^{-1}$ $h$
Transport		
Infiltration	$Q_{ji} C_j$	$g h^{-1}$
Interzonal	$Q_{ji}$ = air flow from zone j	$m^3 h^{-1}$
Soil Gas	$C_i$ = air concentration in zone j	$g m^{-3}$

Diffusion-limited sources (e.g., carpet backing, furniture, flooring, dried paint) represent probably the greatest challenge in source characterization for indoor air quality. Vapor-phase organics dominate this group, offering great complexity because (1) there is a fairly long list of chemicals that could be of concern, (2) ubiquitous consumer products, building materials, coatings, and furnishings contain varying amounts of different chemicals, (3) source dynamics may include nonlinear mechanisms, and (4) for many of the chemicals, emitting as well as non-emitting materials evident in realistic settings may promote reversible and irreversible sink effects. Very detailed descriptions for diffusion-limited sources can be constructed to link specific properties of the chemical, the source material, and the receiving environment to calculate expected behavior (see, for example, Schwoppe et al., 1992; Cussler, 1984). Validation to actual circumstances, however, suffers practical shortfalls because many parameters simply cannot be measured directly.

The exponential formulation listed in Table 17-28 was derived based on a series of papers generated during



the development of chamber testing methodology by EPA (Dunn, 1987; Dunn and Tichenor, 1988; Dunn and Chen, 1993). This framework represents an empirical alternative that works best when the results of chamber tests are available. Estimates for the initial emission rate ( $E_o$ ) and decay factor ( $k_s$ ) can be developed for hypothetical sources from information on pollutant mass available for release ( $M$ ) and supporting assumptions.

Assuming that a critical time period ( $t_c$ ) coincides with reduction of the emission rate to a critical level ( $E_c$ ) or with the release of a critical fraction of the total mass ( $M_c$ ), the decay factor can be estimated by solving either of these relationships:

$$\frac{E_c}{E_o} = e^{-k_s t_c} \quad \text{or} \quad \frac{M_c}{M} = 1 - e^{-k_s t} \quad (\text{Eqn. 17-3})$$

The critical time period can be derived from product-specific considerations (e.g., equating drying time for a paint to 90 percent emissions reduction). Given such an estimate for  $k_s$ , the initial emission rate can be estimated by integrating the emission formula to infinite time under the assumption that all chemical mass is released:

The basis for the exponential source algorithm has also been extended to the description of more complex diffusion-limited sources. With these sources, diffusive or evaporative transport at the interface may be much more rapid than diffusive transport from within the source material, so that the abundance at the source/air interface becomes depleted, limiting the transfer rate to the air. Such effects can prevail with skin formation in "wet" sources like stains and paints (see, for example, Chang and Guo, 1992). Similar emission profiles have been observed with the emanation of formaldehyde from particleboard with "rapid" decline as formaldehyde evaporates from surface sites of the particleboard over the first few weeks. It is then followed by a much slower decline over ensuing years as formaldehyde diffuses from within the matrix to reach the surface (see, for example, Zinn et al., 1990).

Transport-based sources bring contaminated air from other areas into the airspace of concern. Examples include infiltration of outdoor contaminants, and soil gas entry. Soil gas entry is a particularly complex phenomenon, and is frequently treated as a separate modeling issue (Little et al., 1992; Sextro, 1994). Room-to-room migration of indoor contaminants would also fall under this category, but this concept is best considered using the multiple-zone model.

#### 17.4.2. Source Descriptions for Waterborne Contaminants

Residential water supplies may convey chemicals to which occupants can be exposed through ingestion, dermal contact, or inhalation. These chemicals may appear in the form of contaminants (e.g., trichloroethylene) as well as naturally-occurring byproducts of water system history (e.g., chloroform, radon). Among indoor water uses, showering, bathing and handwashing of dishes or clothes provide the primary opportunities for dermal exposure. The escape of volatile chemicals to the gas phase associates water use with inhalation exposure. The exposure potential for a given situation will depend on the source of water, the types and extents of water uses, and the extent of volatilization of specific chemicals. Primary types of residential water use (summarized in Section 17.3) include showering/bathing, toilet use, clothes washing, dishwashing, and faucet use (e.g., for drinking, cooking, general cleaning, or washing hands).

Upper-bounding estimates of chemical release rates from water use can be formulated as simple emission factors by combining the concentration in the feed water ( $\text{g m}^{-3}$ ) with the flow rate for the water use ( $\text{m}^3 \text{h}^{-1}$ ), and assuming that the chemical escapes to the gas phase. For some chemicals, however, not all of the chemical escapes in realistic situations due to diffusion-limited transport and solubility factors. For inhalation exposure estimates, this may not pose a problem because the bounding estimate would overestimate emissions by no more than approximately a factor of two. For multiple exposure pathways, the chemical mass remaining in the water may be

$$M = \int_0^{\infty} E_o e^{-k_s t} dt = \frac{E_o}{k_s} \quad (\text{Eqn. 17-4})$$

of importance. Refined estimates of volatile emissions are usually considered under two-resistance theory to accommodate mass transport aspects of the water-air system (see, for example, Little, 1992; Andelman, 1990; McKone, 1987). Release rates are formulated as:



$$S = K_m F_w \left[ C_w - \frac{C_a}{H} \right] \quad (\text{Eqn. 17-5})$$

where:

S	=	chemical release rate (g h <sup>-1</sup> )
K <sub>m</sub>	=	dimensionless mass-transfer coefficient
F <sub>w</sub>	=	water flow rate (m <sup>3</sup> h <sup>-1</sup> )
C <sub>w</sub>	=	concentration in feed water (g m <sup>-3</sup> )
C <sub>a</sub>	=	concentration in air (g m <sup>-3</sup> )
H	=	dimensionless Henry's Law constant

Because the emission rate is dependent on the air concentration, recursive techniques are required. The mass transfer coefficient is a function of water use characteristics (e.g., water droplet size spectrum, fall distance, water film) and chemical properties (diffusion in gas and liquid phases). Estimates of practical value are based on empirical tests to incorporate system characteristics into a single parameter (see, for example, Giardino et al., 1990). Once characteristics of one chemical-water use system are known (reference chemical, subscript r), the mass transfer coefficient for another chemical (index chemical, subscript i) delivered by the same system can be estimated using formulations identified in the review by Little (1992):

$$\frac{1}{K} \left( \frac{D_{Li}}{D_{Lr}} \right)^{1/2} = \frac{1}{K_{Lr}} = \frac{1}{K_{Gr}} - \frac{1}{H} \left( \frac{D_{Gr}}{D_{Gi}} \right)^{2/3} \left( \frac{D_{Li}}{D_{Lr}} \right)^{1/2} \quad (\text{Eqn. 17-6})$$

where:

D <sub>L</sub>	=	liquid diffusivity (m <sup>2</sup> s <sup>-1</sup> )
D <sub>G</sub>	=	gas diffusivity (m <sup>2</sup> s <sup>-1</sup> )
K <sub>L</sub>	=	liquid-phase mass transfer coefficient
K <sub>G</sub>	=	gas-phase mass transfer coefficient
H	=	dimensionless Henry's Law constant

#### 17.4.3. Soil and House Dust Sources

The rate process descriptions compiled for soil and house dust in Section 17.3 provide inputs for estimating indoor emission rates (S<sub>d</sub>, g h<sup>-1</sup>) in terms of dust mass loading (M<sub>d</sub>, g m<sup>-2</sup>) combined with resuspension rates (R<sub>d</sub>, h<sup>-1</sup>) and floor area (A<sub>f</sub>, m<sup>2</sup>):

$$S_d = M_d R_d A_f \quad (\text{Eqn. 17-7})$$

Because house dust is a complex mixture, transfer of particle-bound constituents to the gas phase may be of concern for some exposure assessments. For emission estimates, one would then need to consider particle mass residing in each reservoir (dust deposit, airborne).

### 17.5. ADVANCED CONCEPTS

#### 17.5.1. Uniform Mixing Assumption

Many exposure measurements are predicated on the assumption of uniform mixing within a room or zone of a house. Mage and Ott (1994) offers an extensive review of the history of use and misuse of the concept. Experimental work by Baughman et al. (1994) and Drescher et al. (1995) indicates that, for an instantaneous release from a point source in a room, fairly complete mixing is achieved within 10 minutes when convective flow is induced by solar radiation. However, up to 100 minutes may be required for complete mixing under quiescent (nearly isothermal) conditions. While these experiments were conducted at extremely low air exchange rates (< 0.1 ACH), based on the results, attention is focused on mixing within a room.

The situation changes if a human invokes a point source for a longer period and remains in the immediate vicinity of that source. Personal exposure in the near vicinity of a source can be much higher than the well-mixed assumption would suggest. A series of experiments conducted by GEOMET (1989) for the U.S. EPA involved controlled point-source releases of carbon monoxide tracer (CO), each for 30 minutes. "Breathing-zone" measurements located within 0.4 m of the release point were ten times higher than for other locations in the room during early stages of mixing and transport.

Similar investigations conducted by Furtaw et al. (1995) involved a series of experiments in a controlled-environment room-sized chamber. Furtaw et al. (1995) studied spatial concentration gradients around a continuous point source simulated by sulfur hexafluoride (SF<sub>6</sub>) tracer with a human moving about the room. Average breathing-zone concentrations when the subject was near the source exceeded those several meters away by a factor that varied inversely with the ventilation intensity in the room. At typical room ventilation rates, the ratio of source-proximate to slightly-removed concentration was on the order of 2:1.

#### 17.5.2. Reversible Sinks

For some chemicals, the actions of reversible sinks are of concern. For an initially "clean" condition in the sink material, sorption effects can greatly deplete indoor concentrations. However, once enough of the chemical has



been adsorbed, the diffusion gradient will reverse, allowing the chemical to escape. For persistent indoor sources, such effects can serve to reduce indoor levels initially but once the system equilibrates, the net effect on the average concentration of the reversible sink is negligible. Over suitably short time frames, this can also affect integrated exposure. For indoor sources whose emission profile declines with time (or ends abruptly), reversible sinks can serve to extend the emissions period as the chemical desorbs long after direct emissions are finished. Reversible sink effects have been observed for a number of chemicals in the presence of carpeting, wall coverings, and other materials commonly found in residential environments.

Interactive sinks (and models of the processes) are of a special importance; while sink effects can greatly reduce indoor air concentrations, re-emission at lower rates over longer time periods could greatly extend the exposure period of concern. For completely reversible sinks, the extended time could bring the cumulative exposure to levels approaching the sink-free case. Recent publications (Axley et al., 1993; Tichenor et al., 1991) show that first principles provide useful guidance in postulating models and setting assumptions for reversible/irreversible sink models. Sorption/desorption can be described in terms of Langmuir (monolayer) as well as Brunauer-Emmet-Teller (BET, multilayer) adsorption.

## **17.6 RECOMMENDATIONS**

Table 17-29 presents a summary of volume of residence surveys and Table 17-30 presents a summary of air exchange rates surveys. Table 17-31 presents the recommended values. Tables 17-32 and 17-33 provide the confidence in recommendations for house volume and air exchange rates, respectively. Key studies or analyses described in this chapter were used in selecting recommended values for residential volume. The air exchange rate data presented in the studies are extremely limited. Therefore, studies have not been classified as key or relevant studies. However, recommendations have been provided for air exchange rates and the confidence recommendation has been assigned a "low" overall rating. Therefore, these values should be used with caution. Both central and conservative values are provided. These two parameters -- volume and air exchange rate -- can be used by exposure assessors in modeling indoor-air concentrations as one of the inputs to exposure estimation. Other inputs to the modeling effort include rates of indoor pollutant generation and losses to (and, in some cases, re-emissions from) indoor sinks. Other things being equal

(i.e., holding constant the pollutant generation rate and effect of indoor sinks), lower values for either the indoor volume or the air exchange rate will result in higher indoor-air concentrations. Thus, values near the lower end of the distribution (e.g., 10th percentile) for either parameter are appropriate in developing conservative estimates of exposure.

For the volume of a residence, both key studies (U.S. DOE (1995) and Versar (1990) PFT database) have the same mean value -- 369 m<sup>3</sup> (see Table 17-1). This mean value is recommended as a central estimate residential volume. Intuitively, the 10th percentile of the distribution from either study -- 147 m<sup>3</sup> for RECS survey or 167 m<sup>3</sup> for the PFT database -- is too conservative a value, as both these values are lower than the mean volume for multifamily dwelling units (see Table 17-2). Instead, the 25th percentile -- 209 m<sup>3</sup> for RECS survey or 225 m<sup>3</sup> for PFT database, averaging 217 m<sup>3</sup> across the two key studies -- is recommended (Table 17-1).

For the residential air exchange rate, the median value of 0.45 air changes per hour (ACH) from the PFT database (see Table 17-9) is recommended as a typical value (Koontz and Rector, 1995). This median value is very close to the geometric mean of the measurements in the PFT database analyzed by Koontz and Rector (1995). The arithmetic mean is not preferred because it is influenced fairly heavily by extreme values at the upper tail of the distribution. For a conservative value, the 10th percentile for the PFT database -- 0.18 ACH -- is recommended (Table 17-10).

There are some uncertainties in, or limitations on, the distribution for volumes and air exchange rates that are presented in this chapter. For example, the RECS used to infer volume distributions used a nationwide probability sample, but measured floor area rather than total volume. By comparison, field studies contributing to the PFT data base measured house volumes directly, but the aggregate sampling frame for these studies is not statistically representative of the national housing stock.

Although the PFT methodology is relatively simple to implement, it is subject to errors and uncertainties. The general performance of the sampling and analytical aspects of the system are quite good. That is, laboratory analysis will measure the correct time-weighted-average tracer concentration to within a few percent (Dietz et al., 1986). Nonetheless, significant errors can arise when conditions in the measurement scene greatly deviate from idealizations calling for constant, well-mixed conditions. Principal concerns focus on the effects of naturally varying air



exchange and the effects of temperature in the permeation source.

Sherman (1989) carried out an error analysis of the PFT methodology using mathematical models combined with typical weather data to calculate how an ideal sampling system would perform in a time-varying environment. He found that for simple single-story (ranch) and two-story plus basement (colonial) layouts, seasonal measurements would underpredict seasonal average air exchange by 20 to 30 percent. Underprediction can occur because the PFT methodology is measuring the effective ventilation (the product of ventilation efficiency and air exchange), and the temporal efficiency will generally be less than unity over averaging periods of this length. Sherman (1989) also noted, however, that while the bias could have an impact on determining air exchange (absent knowledge of ventilation efficiency) for calculating energy loads, the effective air exchange term is directly relevant to determining average indoor concentrations resulting from constant sources.

Leaderer et al. (1985) conducted a series of experiments in a room-sized-environmental chamber to evaluate the practical impacts of varying air exchange and the temperature response of the permeation sources. The negative bias anticipated in the measured (effective) versus actual air exchange as conditions varied diurnally between 0.4 and 1.5. ACH was evident but minor (3 to 6 percent), most likely due to the mechanical mixing in the chamber and the relatively short integration time (72 h). Similarly, cycling temperature diurnally over an 8°C range (holding air exchange steady at 0.6 ACH) would cause concentrations changes of about 20 percent as emissions fluctuated. The investigators found, however, that using a time-weighted average temperature to define the emission rate reduced the temperature bias to essentially zero.

#### 17.7. REFERENCES FOR CHAPTER 17

- Andelman, J.B. (1990) Total exposure to volatile organic compounds in potable water. In: Ram, N, et al., eds. *Significance and Treatment of Volatile Organic Compounds in Water Supplies*. pp 485-504, Lewis Publishers, Chelsea, MI.
- Andersson, B., K. Andersson, J. Sundell, and P.-A. Zingmark. (1993) Mass transfer of contaminants in rotary enthalpy heat exchangers. *Indoor Air*. 3:143-148.
- ASHRAE. (1988) *ASHRAE Handbook: Equipment*. American Society of Heating, Refrigerating, and Air-Conditioning Engineers. Atlanta, GA.
- ASHRAE. (1993) *ASHRAE Handbook: Fundamentals*. American Society of Heating, Refrigerating, and Air-Conditioning Engineers. Atlanta, GA.
- ASTM. (1989) Standard laboratory test method for evaluation of carpet-embedded dirt removal effectiveness of household vacuum cleaners. Designation: F 608-89. American Society for Testing and Materials, Philadelphia, PA.
- ASTM. (1990) Test method for determining formaldehyde levels from wood products under defined conditions using a large chamber. Standard E 1333 90. American Society for Testing and Materials: Philadelphia.
- Axley, J.W. (1988) Progress toward a general analytical method for predicting indoor air pollution in buildings: indoor air quality modeling phase III report. NBSIR 88-3814. National Bureau of Standards, Gaithersberg, MD.
- Axley, J.W. (1989) Multi-zone dispersal analysis by element assembly. *Building and Environment*. 24(2):113-130.
- Axley, J.W.; Lorenzetti, D. (1993) Sorption transport models for indoor air quality analysis. In: Nagda, N.L. Ed., *Modeling of Indoor Air Quality and Exposure*. ASTM STP 1205. Philadelphia, PA: American Society for Testing and Materials, pp. 105-127.
- Baughman, A.V.; Gadgil, A.J.; Nazaroff, W.W. (1994) Mixing of a point source pollutant by natural convection flow within a room. *Indoor Air*. 4:114-122.
- Chang, J.C.S.; Guo, Z. (1992) Characterization of organic emissions from a wood finishing product -- wood stain. *Indoor Air*. 2(3):146-53.
- Consumer Reports. (1982) Washing machines. *Consumer Reports Magazine*. 47(10).
- Consumer Reports. (1987) Dishwashers. *Consumer Reports Magazine*. 52(6).
- Cussler, E.L. (1984) *Diffusion*. Cambridge University Press, New York, NY.
- Dietz, R.N.; Goodrich, R.W.; Cote, E.A.; Wieser, R.F. (1986) Detailed description and performance of a passive perfluorocarbon tracer system for building ventilation and air exchange measurements. H.R. Trechsel and P.L. Lagus, Eds. In: *Measured Air Leakage of Buildings*. ASTM STP 904. Philadelphia, PA: American Society for Testing and Materials, pp. 203-264.



*Chapter 17 - Residential Building Characteristics*

- Drescher, A.C.; Lobascio, C.; Gadgil, A.J.; Nazaroff, W.W. (1995) Mixing of a Point-Source Indoor Pollutant by Forced Convection. *Indoor Air*. 5:204-214.
- Dunn, J.E. (1987) Models and statistical methods for gaseous emission testing of finite sources in well-mixed chambers. *Atmospheric Environment*. (21)2:425-430.
- Dunn, J.E.; Chen, T. (1993) Critical evaluation of the diffusion hypothesis in the theory of porous media volatile organic compounds (VOC) sources and sinks. In: Nagda, N.L. Ed., *Modeling of Indoor Air Quality and Exposure*. ASTM STP 1205. Philadelphia, PA.: American Society for Testing and Materials, pp. 64-80.
- Dunn, J.E.; Tichenor, B.A. (1988) Compensating for sink effects in emissions test chambers by mathematical modeling. *Atmospheric Environ.*, 22(5)885-894.
- EBMUD. (1992) Urban water management plan. East Bay Municipal Utility Water District, in written communication to J.B. Andelman, July 1992.
- Furtaw, E.J.; Pandian, M.D.; Nelson, D.R.; Behar, J.V. (1995) Modeling indoor air concentrations near emission sources in perfectly mixed rooms. *Engineering Solutions to Indoor Air Quality Problems*. Presented at Sixth Conference of the International Society for Environmental Epidemiology and Fourth Conference of the International Society for Exposure Analysis (Joint Conference), Research Triangle Park, NC, September 1994.
- GEOMET. (1989) Assessment of indoor air pollutant exposure within building zones. Report Number IE-2149, prepared for USEPA Office of Health and Environmental Assessment under Contract No. 68-02-4254, Task No. 235. Germantown, MD.: GEOMET Technologies, Inc.
- Giardino, N.J.; Gummerman, E.; Andelman, J.B.; Wilkes, C.R.; Small, M.J. (1990) Real-time measurements of trichloroethylene in domestic bathrooms using contaminated water. *Proceedings of the 5th International Conference on Indoor Air Quality and Climate*, Toronto, 2:707-712.
- Grimsrud, D.T.; Sherman, M.H.; Sondereggen, R.C. (1983) Calculating infiltration: implications for a construction quality standard. In: *Proceedings of the American Society of Heating, Refrigerating and Air-Conditioning Engineers Conference. Thermal Performance of Exterior Envelopes of Buildings II*. ASHRAE SP38, Atlanta, GA, pp. 422-449.
- Grot, R.A. (1991) User manual NBS/AVIS CONTAM88. NISTIR 4585, Gaithersberg, MD: National Institute of Standards and Technology.
- Grot, R.A.; Clark, R.E. (1981) Air leakage characteristics and weatherization techniques for low-income housing. In: *Proceedings of the American Society of Heating, Refrigerating and Air-Conditioning Engineers Conference. Thermal Performance of Exterior Envelopes of Buildings*. ASHRAE SP28, Atlanta, GA, pp. 178-194.
- Hanley, J.T.; Ensor, D.S.; Smith, D.D.; Sparks, L.E. (1994) Fractional aerosol filtration efficiency of in-duct ventilation air cleaners. *Indoor Air*. 4(3):179-188.
- Hirvonen, A.; Pasanen, P.; Tarhanen, J.; Ruuskanen, J. (1995) Thermal desorption of organic compounds associated with settled household dust. *Indoor Air*. 5:255-264.
- Jennings, P.D.; Carpenter, C.E.; Krishnan, M.S. (1985) Methods for assessing exposure to chemical substances volume 12: methods for estimating the concentration of chemical substances in indoor air. EPA 560/5-85-016, U.S. Environmental Protection Agency, Office of Pesticides and Toxic Substances, Washington, DC.
- Jennings, P.D.; Hammerstrom, K.A.; Adkins, L.C.; Chambers, T.; Dixon, D.A. (1987) Methods for assessing exposure to chemical substances volume 7: methods for assessing consumer exposure to chemical substances. EPA 560/5-85-007, U.S. Environmental Protection Agency, Office of Pesticides and Toxic Substances, Washington, DC.
- Koontz, M.D.; Nagda, N.L. (1991) A multichamber model for assessing consumer inhalation exposure. *Indoor Air*. 1(4):593-605.
- Koontz, M.D.; Rector, H.E. (1995) Estimation of distributions for residential air Exchange rates, EPA Contract No. 68-D9-0166, Work Assignment No. 3-19, U.S. Environmental Protection Agency, Office of Pollution Prevention and Toxics, Washington, DC.
- Koontz, M.D.; Rector, H.E.; Fortmann, R.C.; Nagda, N.L. (1988) Preliminary experiments in a research house to investigate contaminant migration in indoor air. EPA 560/5-88-004. U.S. Environmental Protection Agency, Office of Pesticides and Toxic Substances, Washington, DC.
- Layton, D.W.; Thatcher, T.L. (1995) Movement of outdoor particles to the indoor environment: An analysis of the Arnheim Lead Study. Paper No. 95-





- MP4.02. Annual Meeting of the Air and Waste Management Association, San Antonio, TX.
- Leaderer, B.P.; Schaap, L.; Dietz, R.N. (1985) Evaluation of perfluorocarbon tracer technique for determining infiltration rates in residences. *Environ. Sci. and Technol.* 19(12):1225-1232.
- Liddament, M.; Allen, C. (1983) Validation and comparison of mathematical models of air infiltration. Technical Note AIC 11. Air Infiltration Centre, Great Britain.
- Ligman, K.; Hutzler, N.; Boyle, W.C. (1974) Household wastewater characterization. *J. Environ. Eng.* 100:201-213.
- Little, J.C. (1992) Applying the two-resistance theory to contaminant volatilization in showers. *Environ. Sci. and Technol.* 26(7):1341-1349.
- Little, J.C.; Daisey, J.M.; Nazaroff, W.W. (1992) Transport of subsurface contaminants into buildings -- an exposure Pathway for Volatile Organics. *Environ. Sci. and Technol.* (26)11:2058-2066.
- Lucas, R.M.; Grillo, R.B.; Perez-Michael, A.; Kemp, S. (1992) National residential radon survey statistical analysis -- volume 2: summary of the questionnaire data. RTI/5158/49-2F. Research Triangle Institute, Research Triangle Park, NC.
- Mage, D.T.; Ott, W.R. (1994) The correction for nonuniform mixing in indoor environments. *ASTM Symposium on Methods for Characterizing Indoor Sources and Sinks*, Washington, DC.
- McKone, T.E. (1987) Human exposure to volatile organic compounds in household tap water: The inhalation pathway. *Environ. Sci. and Technol.* 21(12):1194-1201.
- McKone, T.E. (1989) Household exposure models. *Toxicol. Letters.* 49:321-339.
- MWD. (1991) Urban water use characteristics in the metropolitan water district of southern california. Draft Report. Metropolitan Water District of Southern California, August 1991.
- Murray, D.M. (1996) residential house and zone volumes in the United States: Empirical and Estimated Parametric Distributions. Submitted to Risk Analysis in 1996.
- Murray, D.M.; Burmaster, D.E. (1995) Residential air exchange rates in the United States: Empirical and Estimated Parametric Distribution by Season and Climatic Region. Submitted to Risk Analysis in 1995.
- Nazaroff, W.W.; Cass, G.R. (1986) Mathematical modeling of chemically reactive pollutants in indoor air. *Environ. Sci. and Technol.* 20:924-934.
- Nazaroff, W.W.; Cass, G.R. (1989) Mass-transport aspects of pollutant removal at indoor surfaces. *Environment International*, 15:567-584.
- Nazaroff, W.W.; Doyle, S.M.; Nero, A.V.; Sextro, R.G. (1988). Radon entry via potable water. In: Nazaroff, W.W. and Nero, A.V., Eds., *Radon and Its Decay Products in Indoor Air*. John Wiley and Sons, NY. pp. 131-157.
- Nazaroff, W.W.; Gadgil, A.J.; Weschler, C.J. (1993) Critique of the use of deposition velocity in modeling indoor air quality. In: Nagda, N.L. Ed., *Modeling of Indoor Air Quality and Exposure*, ASTM STP 1205, American Society for Testing and Materials, Philadelphia, PA, pp. 148-165.
- Offerman, F.J.; Sextro, R.G.; Fisk, W.; Nazaroff, W.W.; Nero, A.V.; Revzan, K.L.; Yater, J. (1984) Control of respirable particles and radon progeny with portable air cleaners. Report No. LBL-16659, Lawrence Berkley Laboratory, Berkley, CA.
- Pandian, M.H.; Behar, J.V.; Thomas, J. (1993) Use of a relational database to predict human population exposures for different time periods. *Proceedings of Indoor Air '93, Helsinki* 3:283-288.
- Persily, A.K.; Linteris, G.T. (1984) A comparison of measured and predicted infiltration rates. *ASHRAE Transactions* 89(2):183-199.
- Relwani, S.M.; Moschandreas, D.J.; Billick, I.H. (1986) Effects of operational factors on pollutant emission rates from residential gas appliances. *J. Air Poll. Control Assoc.* 36:1233-1237.
- Roberts, J.W.; Budd, W.T.; Ruby, M.G.; Bond, A.E.; Lewis, R.G.; Wiener, R.W.; Camann, D.E. (1991) Development and field testing of a high volume sampler for pesticides and toxics in dust. *J. Exposure Anal. and Environ. Epidemiol.* (1)2:143-155
- Ryan, P.B. (1991) An overview of human exposure modeling. *J. Exposure Anal. and Environ. Epidemiol.* (1)4:453-474.
- Sandberg, M. (1984) The Multi-chamber theory reconsidered from the viewpoint of air quality studies. *Building and Environment* (19)4:221-233.
- Sextro, R.G. (1994) Radon and the natural environment. IN: Nagda, N.L. Ed., *Radon -- Prevalence, Measurements, Health Risks and Control*, ASTM MNL 15, American Society for Testing and Materials, Philadelphia, PA, pp. 9-32.



- Shaughnessy, R.J.; Levetin, E.; Blocker, J.; Sublette, K.L. (1994) Effectiveness of portable air cleaners: sensory testing results. *Indoor Air* 4(3):179-188.
- Sherman, M.H. (1989) Analysis of errors associated with passive ventilation measurement techniques. *Building and Environment* 24(2):131-139.
- Sherman, M.; Dickerhoff, D. (1996) Air tightness of U.S. dwellings. In: *The Role of Ventilation 15th AIVC Conference Proceedings*. Buxton, Great Britain, September 27-30, 1994.
- Siegrist, R. (1976) Characteristics of rural household wastewater. *J. Environ. Eng.* 1:533-548.
- Sinden, F.W. (1978) Multi-chamber theory of infiltration. *Building and Environment*. 13:21-28.
- Sparks, L.E. (1988) Indoor air quality model version 1.0. Report No. EPA-600/8-88-097a.. Research Triangle Park, NC. U.S. Environmental Protection Agency.
- Sparks, L.E. (1991) Exposure - Version 2., U.S. Environmental Protection Agency, Office of Research and Development, Research Triangle Park, NC.
- Swope, A.D.; Goydan, R.; Reid, R.C. (1992) Methods for assessing exposure to chemical substances Volume 11: Methodology for Estimating the Migration of Additives and Impurities from Polymeric Substances. EPA 560/5-85-015, U.S. Environmental Protection Agency, Office of Pollution Prevention, Pesticides, and Toxic Substances, Washington, DC.
- Thatcher, T.L.; Layton, D.W. (1995) Deposition, resuspension, and penetration of particles within a residence. *Atmos. Environ.* 29(13):1487-1497.
- Thompson, W. (1995) U.S. Department of Energy (U.S. DOE) and Energy Information Administration. Personal communication on distribution of heated floor space area from the 1993 RECS.
- Tichenor, B.A.; Guo, Z.; Dunn, J.E.; Sparks, L.E.; Mason, M.A. (1991) The interaction of vapor phase organic compounds with indoor sinks. *Indoor Air* 1:23-35.
- Tucker, W.G. (1991) Emission of organic substances from indoor surface materials. *Environ. Internat.* 17:357-363.
- U.S. Bureau of the Census. (1992) Statistical abstract of the United States: 1992 (112th edition). Table No. 1230, p. 721. Washington, DC.: U.S. Department of Commerce.
- U.S. DHUD. (1984) Residential water conservation projects: summary report. Report Number HUD-PDR-903. Washington, DC: U.S. Department of Housing and Urban Development, Office of Policy Development and Research.
- U.S. DOE. (1995) Housing characteristics 1993, Residential Energy Consumption Survey (RECS) Report No. DOE/EIA-0314 (93), Washington, DC: U.S. Department of Energy, Energy Information Administration.



- Versar. (1990) Database of perfluorocarbon tracer (PFT) ventilation measurements: description and user's manual. USEPA Contract No. 68-02-4254, Task No. 39. Washington, D.C: U.S.Environmental Protection Agency, Office of Toxic Substances.
- Wallace, L.A. (1996) Indoor particles: A review. *J. Air and Waste Management Assoc.* (46)2:98-126.
- Walton, G.N. (1993) CONTAM 93 User Manual. NISTIR 5385. Gaithersburg, MD: National Institute of Standards and Technology.
- Wilkes, C.R.; Small, M.J.; Andelman, J.B.; Giardino, N.J.; Marshall, J. (1992) Inhalation exposure model for volatile chemicals from indoor uses of water. *Atmospheric Environment* (26A)12:2227-2236.
- Wolkoff, P. (1995) Volatile organic compounds: sources, measurements, emissions, and the impact on indoor air quality. *Indoor Air Supplement No. 3/95*, pp 1-73.
- Wolkoff, P.; Wilkins, C.K. (1994) Indoor VOCs from household floor dust: comparison of headspace with desorbed VOCs; Method for VOC release determination. *Indoor Air* 4:248-254.
- Zinn, T.W.; Cline, D.; Lehmann, W.F. (1990) Long-term study of formaldehyde emission decay from particleboard. *Forest Products Journal* (40)6:15-18.



Table 17-29. Volume of Residence Surveys

Study	Number of Residences	Survey Type	Areas Surveyed	Comments
<u>Key Studies</u>				
U.S. DOE, 1995 (RECS)	Over 7,000	Direct measurement of floor area; estimation of volume	Nationwide (random sample)	Volumes were estimated assuming 8 ft. ceiling height. Provides relationships between average residential volumes and facilities such as housing type, ownership, household size, and structure age.
Versar, 1990 (PFT database)	Over 2,000	Direct measurement and estimated	Nationwide (not random sample); a large fraction located in CA	Sample was not geographically balanced; statistical weighting was applied to develop nationwide distributions
Murray, 1996	7,041 (RECS) 1,751 (PFT)	Direct measurements and estimated	RECS-Nationwide (random sample); PFT - Nationwide (not random sample); a large fraction located in CA	Duplicate measurement were eliminated; tested the effects of using 8 ft. assumption on ceiling height to calculate volume; data from both databases were analyzed.

Table 17-30. Air Exchange Rates Surveys

Study	Number of Residences/Measurements	Survey Type	Areas Surveyed	Comments
Versar, 1990 (PFT database)	Over 2,000 residences	Measurements using PFT technique	Nationwide (not random sample); a large fraction located in CA	Multiple measurements on the same home were included.
Koontz & Rector, 1995 (PFT database)	2,971 measurements	Measurements using PFT technique	Nationwide (not random sample); a large fraction located in CA	Multiple measurements on the same home were included. Compensated for geographic imbalances. Data are presented by region of the country and season.
Murray and Burmaster, 1995 (PFT database)	2,844 measurements	Measurements using PFT technique	Nationwide (not random sample); a large fraction located in CA	Multiple measurements on the same home were included. Did not compensate for geographical imbalances. Data are presented by climate region and season.
Nazaroff et al., 1988	255 (Grot and Clark, 1981)	Direct measurement	255, low-income families in 14 cities	Sample size was small and not representative of the U.S.
	312 (Grimsrud, 1983)	Direct measurement	321, newer residences, median age <10 years	Sample size was small and not representative of the U.S.



Table 17-31. Recommendations - Residential Parameters		
Volume of Residence	369 m <sup>3</sup> (central estimate) <sup>a</sup>	217 m <sup>3</sup> (mean) <sup>b</sup>
Air Exchange Rate	0.45 ACH (median) <sup>c</sup>	0.18 ACH (10th percentile) <sup>d</sup>
<p>a Same mean value presented in two studies (Table 17-1) - recommended to be used as the central estimate.</p> <p>b Mean of two 25th percentile values (Table 17-1) - recommended to be used as the mean value.</p> <p>c Recommended to be used as a typical value (Table 17-10).</p> <p>d Recommended to be used as a conservative value (Table 17-10).</p>		

Table 17-32. Confidence in House Volume Recommendations		
Considerations	Rationale	Rating
<b>Study Elements</b>		
• Level of peer review	All key studies are from peer reviewed literature.	High
• Accessibility	Papers are widely available from peer review journals.	High
• Reproducibility	Direct measurements were made.	High
• Focus on factor of interest	The focus of the studies was on estimating house volume as well as other factors.	High
• Data pertinent to U.S.	Residences in the U.S. was the focus of the key studies.	High
• Primary data	All the studies were based on primary data.	High
• Currency	Measurements in the PFT database were taken between 1982-1987. The RECS survey was conducted in 1993.	Medium
• Adequacy of data collection period	Not applicable	
• Validity of approach	For the RECS survey, volumes were estimated assuming an 8 ft. ceiling height. The effect of this assumption has been tested by Murray (1996) and found to be insignificant.	Medium
• Study size	The sample sizes used in the key studies were fairly large, although only 1 study (RECS) was representative of the whole U.S. Not all samples were selected at random; however, RECS samples were selected at random.	Medium
• Representativeness of the population	RECS sample is representative of the U.S.	Medium
• Characterization of variability	Distributions are presented by housing type and regions; although some of the sample sizes for the subcategories were small.	Medium
• Lack of bias in study design (high rating is desirable)	Selection of residences was random for RECS.	Medium
• Measurement error	Some measurement error may exist since surface areas were estimated using the assumption of 8 ft. ceiling height.	Medium
<b>Other Elements</b>		
• Number of studies	There are 3 key studies; however there are only 2 data sets.	Low
• Agreement between researchers	There is good agreement among researchers.	High
<b>Overall Rating</b>	Results were consistent; 1 study (RECS) was representative of residences in the whole U.S.; volumes were estimated rather than measured in some cases.	Medium



Table 17-33. Confidence in Air Exchange Rate Recommendations

Considerations	Rationale	Rating
<b>Study Elements</b>		
<ul style="list-style-type: none"> <li>Level of peer review</li> </ul>	The studies appear in peer reviewed literature. Although there are 3 studies, they are all based on the same database (PFT database).	High
<ul style="list-style-type: none"> <li>Accessibility</li> </ul>	Papers are widely available from government reports and peer review journals.	High
<ul style="list-style-type: none"> <li>Reproducibility</li> </ul>	Precision across repeat analyses has been documented to be acceptable.	Medium
<ul style="list-style-type: none"> <li>Focus on factor of interest</li> </ul>	The focus of the studies was on estimating air exchange rates as well as other factors.	High
<ul style="list-style-type: none"> <li>Data pertinent to U.S.</li> </ul>	Residences in the U.S. was the focus of the PFT database.	High
<ul style="list-style-type: none"> <li>Primary data</li> </ul>	All the studies were based on primary data.	High
<ul style="list-style-type: none"> <li>Currency</li> </ul>	Measurements in the PFT database were taken between 1982-1987.	Medium
<ul style="list-style-type: none"> <li>Adequacy of data collection period</li> </ul>	Only short term data were collected; some residences were measured during different seasons; however, long term air exchange rates are not well characterized.	Medium
<ul style="list-style-type: none"> <li>Validity of approach</li> </ul>	Although the PFT technology is an EPA standard method (Method IP-4A), it has some major limitations (e.g., uniform mixing assumption).	Low
<ul style="list-style-type: none"> <li>Study size</li> </ul>	The sample sizes used in the key studies were fairly large, although not representative of the whole U.S. Not all samples were selected at random.	Medium
<ul style="list-style-type: none"> <li>Representativeness of the population</li> </ul>	Sample is not representative of the U.S..	Low
<ul style="list-style-type: none"> <li>Characterization of variability</li> </ul>	Distributions are presented by U.S. regions, seasons, and climatic regions; although some of the sample sizes for the subcategories were small and not representative of U.S. The utility is limited..	Low
<ul style="list-style-type: none"> <li>Lack of bias in study design (high rating is desirable)</li> </ul>	Bias may result since the selection of residences was not random.	Low
<ul style="list-style-type: none"> <li>Measurement error</li> </ul>	Some measurement error may exist.	Medium
<b>Other Elements</b>		
<ul style="list-style-type: none"> <li>Number of studies</li> </ul>	There are 3 key studies; however there are only 1 data set. However, the database contains results of 20 projects of varying scope.	Medium
<ul style="list-style-type: none"> <li>Agreement between researchers</li> </ul>	Not applicable	
<b>Overall Rating</b>	Sample was not representative of residences in the whole U.S., but covered the range of occurrence. PFT methodology has limitations. Uniform mixing assumption may not be adequate. Results will vary depending on placement of samples and on whether windows and doors are closed or opened.	Low