

NUREG/CR-5512
PNL-7994
Vol. 1

Residual Radioactive Contamination From Decommissioning

Technical Basis for Translating Contamination
Levels to Annual Total Effective Dose Equivalent

Final Report

Prepared by
W. E. Kennedy, Jr., D. L. Strenge

Pacific Northwest Laboratory
Operated by
Battelle Memorial Institute

Prepared for
U.S. Nuclear Regulatory Commission

AVAILABILITY NOTICE

Availability of Reference Materials Cited in NRC Publications

Most documents cited in NRC publications will be available from one of the following sources:

1. The NRC Public Document Room, 2120 L Street, NW., Lower Level, Washington, DC 20555
2. The Superintendent of Documents, U.S. Government Printing Office, P.O. Box 37082, Washington, DC 20013-7082
3. The National Technical Information Service, Springfield, VA 22161

Although the listing that follows represents the majority of documents cited in NRC publications, it is not intended to be exhaustive.

Referenced documents available for inspection and copying for a fee from the NRC Public Document Room include NRC correspondence and internal NRC memoranda; NRC bulletins, circulars, information notices, inspection and investigation notices; licensee event reports; vendor reports and correspondence; Commission papers; and applicant and licensee documents and correspondence.

The following documents in the NUREG series are available for purchase from the GPO Sales Program: formal NRC staff and contractor reports, NRC-sponsored conference proceedings, international agreement reports, grant publications, and NRC booklets and brochures. Also available are regulatory guides, NRC regulations in the *Code of Federal Regulations*, and *Nuclear Regulatory Commission Issuances*.

Documents available from the National Technical Information Service include NUREG-series reports and technical reports prepared by other Federal agencies and reports prepared by the Atomic Energy Commission, forerunner agency to the Nuclear Regulatory Commission.

Documents available from public and special technical libraries include all open literature items, such as books, journal articles, and transactions. *Federal Register* notices, Federal and State legislation, and congressional reports can usually be obtained from these libraries.

Documents such as theses, dissertations, foreign reports and translations, and non-NRC conference proceedings are available for purchase from the organization sponsoring the publication cited.

Single copies of NRC draft reports are available free, to the extent of supply, upon written request to the Office of Administration, Distribution and Mail Services Section, U.S. Nuclear Regulatory Commission, Washington, DC 20555.

Copies of industry codes and standards used in a substantive manner in the NRC regulatory process are maintained at the NRC Library, 7920 Norfolk Avenue, Bethesda, Maryland, for use by the public. Codes and standards are usually copyrighted and may be purchased from the originating organization or, if they are American National Standards, from the American National Standards Institute, 1430 Broadway, New York, NY 10018.

DISCLAIMER NOTICE

This report was prepared as an account of work sponsored by an agency of the United States Government. Neither the United States Government nor any agency thereof, or any of their employees, makes any warranty, expressed or implied, or assumes any legal liability of responsibility for any third party's use, or the results of such use, of any information, apparatus, product or process disclosed in this report, or represents that its use by such third party would not infringe privately owned rights.

NUREG/CR-5512
PNL-7994
Vol. 1

Residual Radioactive Contamination From Decommissioning

Technical Basis for Translating Contamination
Levels to Annual Total Effective Dose Equivalent

Final Report

Manuscript Completed: September 1992
Date Published: October 1992

Prepared by
W. E. Kennedy, Jr., D. L. Strenge

R. A. Meck, Ph.D., NRC Project Manager
Christine Daily, NRC Technical Specialist

Pacific Northwest Laboratory
Richland, WA 99352

Prepared for
Division of Regulatory Applications
Office of Nuclear Regulatory Research
U.S. Nuclear Regulatory Commission
Washington, DC 20555
NRC FIN B2908

Abstract

This document is the first volume of a three-volume report to provide generic and site-specific estimates of radiation dose for exposures to residual radioactive contamination after the decommissioning of facilities licensed by the U.S. Nuclear Regulatory Commission (NRC). This first volume provides the details of the generic scenario and pathway modeling analysis. The level of detail included in this volume serves as the basis for user-friendly computer software to be developed under strict quality-assurance procedures. This volume is intended to be used as a reference to Volume 2, a full description of the computer software. Included in Volume 1 are descriptions of the scenarios, models, mathematical formulations, assumptions, and justifications of parameter selections. Volume 1 was produced after consideration of public comments received on the January 1990 review draft. The generic modeling addresses residual radioactive contamination inside buildings and in soils. For buildings, two scenarios are presented to relate volume and surface contamination levels to estimates of the annual total effective dose equivalent (TEDE) or the TEDE (as defined in 10 CFR 20) received during a year of exposure with the conditions defined in the scenarios. Because of concerns regarding potential ground-water contamination from residual radioactive contamination in soil, a generic water-use model was developed to permit evaluation of the annual TEDE for drinking water from wells. The generic water-use model was also used in the evaluation of multiple pathways associated with contaminated soil. The generic treatment of potentially complex ground-water systems used here provides a conservative analysis that may only indicate that additional site data and more sophisticated modeling are warranted. The scenarios, models, mathematical formulations, and selected parameter values in this volume are intended to serve as the technical basis for the NRC's derivation of screening values supporting its development of policy applied to residual radioactive contamination from decommissioning.

Contents

	Page
Abstract	iii
Executive Summary	xiii
Foreword	xv
Acknowledgments	xix
1 Introduction	1.1
2 Methodology and Nomenclature	2.1
2.1 Dosimetry Definitions	2.1
2.2 Symbol Nomenclature	2.2
3 Scenario Descriptions for the Release of Buildings	3.1
3.1 Building Renovation Scenario	3.1
3.1.1 Time Frame for Building Renovation Scenario	3.2
3.1.2 Exposure Pathways for Building Renovation Scenario	3.3
3.1.3 External Dose	3.5
3.1.4 Inhalation Dose for Renovation	3.7
3.1.5 Ingestion Dose for Renovation	3.7
3.1.6 Annual TEDE Rate for the Building Renovation Scenario	3.8
3.2 Building Occupancy Scenario	3.9
3.2.1 Time Frame of Building Occupancy Scenario	3.9
3.2.2 Exposure Pathways	3.9
3.2.3 External Dose for Building Occupancy	3.12
3.2.4 Inhalation Dose for Building Occupancy	3.12
3.2.5 Ingestion Dose for Building Occupancy	3.13
3.2.6 Annual TEDE Rate for Building Occupancy Scenario	3.14
4 Drinking Water Scenario	4.1
4.1 Water-Use Model	4.2
4.1.1 Characteristics of Water-Use Model Suitable for Screening	4.2
4.1.2 Three-Box Water-Use Model	4.3
4.1.3 Equations for Radionuclide Transfer in Soil Using the Water-Use Model	4.5

Contents

4.2 Calculation of Annual TEDE	4.11
5 Residential Scenario	5.1
5.1 Residential Scenario: Concepts and Assumptions	5.2
5.1.1 Time Frame for the Residential Scenario	5.2
5.1.2 Exposure Pathways for the Residential Scenario	5.2
5.2 Steps for Calculating Annual Dose from Agricultural Pathways	5.5
5.3 Concentrations and Transfer Factors for Resuspension and Root Uptake From Soil	5.9
5.3.1 Soil-Plant-Human Pathway	5.9
5.3.2 Animal Products Contaminated by Soil Sources	5.14
5.4 Concentrations and Transfer Factors for Irrigation Water as the Contaminating Medium	5.24
5.4.1 Food Crops Contaminated by Irrigation Water	5.24
5.4.2 Animal Products Contaminated by Irrigation Water	5.33
5.5 Calculation of Pathway Transfer Factors	5.51
5.6 Calculation of Total Dose From Pathways for the Residential Scenario	5.52
5.6.1 External Dose for the Residential Scenario	5.52
5.6.2 Inhalation Dose for the Residential Scenario	5.54
5.6.3 Ingestion Dose for the Residential Scenario	5.56
5.6.4 Irrigation and Drinking Water Dose for the Residential Scenario	5.58
5.6.5 Aquatic Food Ingestion Dose for the Residential Scenario	5.59
5.6.6 Water-Use Model for the Residential Scenario	5.61
5.7 Total Dose for Residential Scenario	5.70
6 Selected Parameter Values	6.1
6.1 Radioactive Decay Data	6.1
6.1.1 Conventions for Handling Radioactive Chain Decay	6.1
6.1.2 Decay Chain Data	6.2

6.2 Dosimetry Database	6.3
6.2.1 External Dose Rate Conversion Factors	6.3
6.2.2 Inhalation and Ingestion Dose Conversion Factors	6.6
6.2.3 Dose and Dose Rate Factor Working Units	6.7
6.2.4 Dose Factors For Decay Chains	6.9
6.3 Media-Specific Considerations for Exposure Scenarios	6.10
6.3.1 Air Concentrations for Inhalation	6.10
6.3.2 Secondary Ingestion Rates	6.12
6.4 Water-Use Model Data	6.16
6.5 Agricultural Pathway Data	6.19
6.5.1 Animal Feed Intake Rates	6.19
6.5.2 Plant Soil Mass-Loading Factor	6.20
6.5.3 Holdup Times	6.21
6.5.4 Exposure Period/Animal Feeding Times	6.21
6.5.5 Crop-Growing Periods	6.21
6.5.6 Translocation Fraction from Leaves to Edible Parts	6.22
6.5.7 Crop Yields	6.23
6.5.8 Consumption and Intake Parameters for Humans	6.24
6.5.9 Agricultural Pathway Transfer Factors	6.24
6.6 Aquatic Food Pathway Data	6.28
6.7 Summary of Parameters That May Vary and Default Value Assignments	6.31
6.7.1 Parameters for the Building Renovation Scenario	6.33
6.7.2 Parameters for the Building Occupancy Scenario	6.33
6.7.3 Parameters for the Drinking Water Scenario	6.34
6.7.4 Parameters for the Residential Scenario	6.36
7 Discussion	7.1
7.1 Generic Modeling Approach	7.1
7.2 Generic Scenarios	7.2
7.3 Applications	7.3
8 References	8.1
Appendix A: NRC Staff and Technical Responses to Comments on NUREG/CR-5512 - Residual Radioactive Contamination from Decommissioning: Technical Basis for Translating Contamination Levels to Annual Dose, Draft Report for Comment - January 1990	A.1
A.1 Policy Issues and Regulatory Perspective	A.2
A.2 Measurements and Survey Considerations	A.5
A.3 Textual Errors and Editorial Improvements	A.8

Contents

A.4 Technical Considerations	A.9
A.4.1 Radioactive Chain Decay Methods	A.9
A.4.2 External Dose Rate Calculations	A.11
A.4.3 Water-Use Model and the Drinking Water Scenario	A.13
A.4.4 Models	A.16
A.4.5 Data Selections	A.19
A.4.6 Other Pathways and Scenarios	A.21
A.4.7 Airborne Dust-Loadings	A.22
A.5 Model Verification	A.24
A.6 Other Issues	A.26
A.7 References	A.27
Appendix B: Extended Nomenclature and Methodology	B.1
B.1 Radionuclide Decay Calculations	B.1
B.1.1 General Decay Equations	B.2
B.1.2 Equations for Decay with Removal	B.5
B.1.3 Decay Equation Units	B.7
B.2 Radioactive Decay Operators	B.8
B.2.1 Decay Operator with Removal $A_e\{\}$	B.8
B.2.2 Decay Operator $A\{\}$	B.10
B.3 Time-Integral Operators	B.21
B.3.1 Time-Integral Operator with Removal, $S_e\{\}$	B.21
B.3.2 Time-Integral Operator, $S\{\}$	B.21
B.4 Deposition, Accumulation Operators	B.22
B.4.1 Deposition, Accumulation with Removal Operator, $Re\{\}$	B.22
B.4.2 Deposition, Accumulation Operator, $R\{\}$	B.26
B.5 Use of Deposition, Accumulation, and Time-Integral Equations	B.26
B.5.1 Deposition, Accumulation, and Time-Integral with Removal Operator $G_e\{\}$	B.26
B.5.2 Deposition, Accumulation, and Time-Integral with Removal Operator $G_e\{\}$	B.27
B.6 Water-Use Model for the Drinking Water Scenario	B.27
B.6.1 Demonstration of Equations for Drinking Water Water-Use Model	B.27
B.6.2 Solution to Water-Use Model for the Drinking Water Scenario	B.41

B.7 Water-Use Model for the Residential Scenario	B.47
B.8 References	B.50
Appendix C: Carbon-14 Agricultural Pathway Model	C.1
C.1 Transfer of Carbon-14 from Soil to Plants	C.1
C.2 Transfer of Carbon-14 to Animal Products	C.1
C.3 Special Parameters for the Carbon-14 Model for Crops and Animal Products	C.4
C.4 References	C.5
Appendix D: Tritium Agricultural Pathway Model	D.1
D.1 Transfer of Tritium from Soil to Plants and Animal Products	D.1
D.2 Transfer of Tritium from Irrigation Water to Plants and Animal Products	D.4
D.3 Special Parameters for the Tritium Model for Crops and Animal Products	D.6
D.4 References	D.7
Appendix E: Supplemental Data	E.1
E.1 Contents and Units of Tables	E.1
E.2 References	E.2
Appendix F: Glossary	F.1

Figures

3.1 Potential activities within the building renovation	3.2
3.2 Building renovation time frame	3.3
3.3 Potential activities within the building occupancy scenario	3.10
3.4 Building occupancy time line	3.11
4.1 Drinking water dose pathway	4.1
4.2 Time frame for drinking water scenario	4.1
4.3 Example of time dependence of ground-water concentration	4.2
4.4 Conceptual representation of the drinking water scenario water-use model	4.4
4.5 Three-box water-use model for the drinking water scenario	4.6
5.1 Potential activities within the residential scenario	5.1
5.2 Relationship of soil contamination to agricultural pathways	5.4
5.3 Modeling details for the residential scenario exposure pathways	5.6
5.4 Process for estimating annual TEDEs for the agricultural pathways	5.7
5.5 PPTF analysis for decay chain radionuclides	5.8
5.6 Soil-plant-human pathway	5.10
5.7 Change in relative concentrations over time for soil and plant crops from root uptake	5.11
5.8 Soil-plant-animal-human pathway	5.16
5.9 Change in relative concentrations over time for soil, stored feed, animal products, and human foods from the root-uptake pathway	5.17
5.10 Changes in relative concentrations over time for soil, fresh feed, animal products, and human foods from the root uptake pathway	5.20
5.11 Water-plant-human pathway and water-soil-plant-human pathway	5.25
5.12 Changes in relative concentrations over time for irrigation water, plants, and human food from deposition of irrigation water onto plant surfaces	5.26
5.13 Change in relative concentrations over time for irrigation water, soil, plants, and human foods from deposition of irrigation water on soil with subsequent root uptake	5.29
5.14 Water-plant-animal-human pathway and water-soil-plant-animal-human pathway	5.35
5.15 Change in relative concentrations over time for irrigation water, forage, animal products, and human foods from deposition of irrigation water on animal forage	5.36

5.16 Change in relative concentrations over time for irrigation water, soil, forage, animal products, and human foods from deposition of irrigation water on soil with subsequent resuspension and root uptake to forage plants	5.39
5.17 Change in relative concentrations over time for irrigation water, stored feed, animal products, and human food from deposition of irrigation water on stored feed plants	5.42
5.18 Change in relative concentrations over time for irrigation water, soil, stored feed, animal products, and human foods from deposition of irrigation water on soil with subsequent resuspension and root uptake by stored feed crops	5.44
5.19 Residential scenario external dose pathway	5.53
5.20 Residential scenario inhalation dose pathways	5.55
5.21 Residential scenario ingestion dose pathway for plants and animal products contaminated from soil ...	5.56
5.22 Residential scenario soil ingestion dose pathway	5.57
5.23 Residential scenario ingestion dose from use of contaminated ground water	5.58
5.24 Residential scenario ingestion dose from use of contaminated ground water to grow fish in a surface-water pond	5.60
5.25 Concept representations of the residential scenario water-use model	5.61
5.26 Residential three-box water-use model	5.64
5.27 Annual sequence of analyses	5.65
6.1 Relative external dose rate for uniform and nonuniform source distributions on interior surfaces of a room as a function of room volume	6.4
6.2 Relative external dose rate as a function of soil source area and thickness for ⁶⁰ Co	6.6
A.1 Hypothetical flow diagram for release criteria	A.3
B.1 Residential scenario three-box water-use model	B.48

Tables

2.1 Dosimetry parameters	2.3
2.2 Subscripted parameter summary	2.6
2.3 Unsubscripted parameters	2.16
2.4 Summary of operator notation equations	2.19
2.5 Summary of water-use model operator notation equations	2.20
6.1 Unit conversion factors for external dose	6.7
6.2 Unit conversion factors for inhalation dose factors	6.8
6.3 Unit conversion factors for ingestion dose factors	6.9
6.4 Reported resuspension information	6.13
6.5 Referenced surface-contamination ingestion data	6.15
6.6 Referenced secondary soil ingestion rates	6.16
6.7 Partition coefficients for the water-use model	6.18
6.8 Animal feed and water intake rates	6.19
6.9 Summary of plant mass-loading data	6.22
6.10 Summary of effective concentration ratio data	6.22
6.11 Holdup time for food consumption	6.23
6.12 Minimum crop-growing periods	6.23
6.13 Crop yields for animal products	6.23
6.14 Crop yields for food crops	6.23
6.15 Daily ingestion rates for foods	6.24
6.16 Soil-to-plant concentration factors	6.25
6.17 Dry- to wet-weight conversion factors	6.28
6.18 Animal product transfer factors	6.29
6.19 Fish bioaccumulation factors for the residential scenario	6.32
6.20 Building renovation scenario parameters that may vary and generic default values	6.33
6.21 Building occupancy scenario parameters that may vary and generic default values	6.34
6.22 Drinking water scenario parameters that may vary and generic default values	6.35
6.23 Residential scenario parameters that may vary and generic default values	6.37
6.24 ¹⁴ C model residential scenario parameters that may vary and generic default values	6.47
6.25 ³ H model residential scenario parameters that may vary and generic default values	6.48
A.1 List of public commenters	A.1
B.1 System matrix generation table	B.48
C.1 Carbon model parameter values	C.4
D.1 Tritium agricultural model parameter values	D.7
E.1 Radioactive decay data and decay chain specifications	E.3
E.2 Internal committed effective dose equivalent and external effective dose equivalent factors	E.15
E.3 Ingestion organ dose equivalent factors for organ set 1	E.22
E.4 Ingestion organ dose equivalent factors for organ set 2	E.29
E.5 Ingestion organ dose equivalent factors for organ set 3	E.36
E.6 Inhalation class and gastrointestinal tract uptake fractions for internal dose factors	E.43

Executive Summary

The three volumes of this document describe a generic modeling analysis of the potential radiation doses resulting from unrestricted release of slightly radioactive material in buildings and soil following decommissioning of licensed facilities. This first volume contains detailed information on the generic scenario and modeling analysis as the basis for user-friendly computer software to be developed under strict quality-assurance procedures. This document is intended to be used as a reference to the user's manual for the software (Volume 2) and has been revised in light of the public comments received on the January 1990 draft. The information in this document is intended to serve as the technical basis for the U.S. Nuclear Regulatory Commission's (NRC's) derivation of screening values supporting its development of policy on residual radioactive contamination from decommissioning. A user's manual for the software version of the modeling analysis and a sensitivity analysis of parameter values used in the analysis will be documented and distributed as two additional volumes.

The radiation exposure scenario analysis addresses the major exposure pathways of direct exposure to penetrating radiation, and inhalation and ingestion of radioactive materials. The modeling analysis is used to estimate the annual total effective dose equivalent (TEDE), or the TEDE (as defined in 10 CFR 20 [56 FR 23360-23474, 1991]) received during a year of scenario exposure, to an average individual in a population group exposed to residual radioactive material after decommissioning. The input parameters for each exposure pathway and scenario are selected in a prudently conservative (not worst-case) manner to estimate the likely radiation dose to an individual in a limited population group exposed to residual radioactive contamination. A prudently conservative generic approach is necessary so that it is more likely that the calculations will produce overestimates than underestimates of the potential dose an individual in the general public may receive.

For unrestricted release of buildings, two independent scenarios are provided: building renovation for volume sources of residual radioactive contamination and building occupancy for surface sources of residual radioactive contamination. In order to accommodate site-specific conditions, the computer software containing the modeling analysis will be designed to permit simple modifications of the scenario assumptions, including the exposure durations, intake rates, or concentrations in various pathway media.

For unrestricted use of land, two scenarios are included that rely on a generic water-use model. The first scenario considers drinking water from a well and accounts for the total radionuclide inventory at the site, in the soil, and in building materials that potentially may be demolished and disposed of onsite as buried rubble. The drinking water scenario relates the annual TEDE to the total inventory of residual radioactivity in soil. The second scenario considers residential use of land, including use of ground water for drinking and irrigation of farm products. The residential scenario includes a combination of the following exposure pathways: inhalation, external exposure, drinking water ingestion, soil ingestion, and agricultural food product ingestion.

Because of the generic treatment of potentially complex ground-water systems, the water-use modeling and parameter selection are intentionally conservative. This means that the estimated annual TEDE for the drinking water and residential scenarios may only indicate when additional site data or more sophisticated modeling are warranted. Modifications can be made to the scenarios for contaminated land to better account for site-specific soil contamination using the software developed for this effort.

Finally, appendixes are provided to this report to summarize the general responses to comments received on the January 1990 (Kennedy and Peloquin 1990) draft version of this final report, and to support information and databases in the modeling analysis.

Foreword

by
Nuclear Regulatory Commission (NRC) Staff

NRC licensees who need to decontaminate lands and structures to acquire unrestricted use of their property must have criteria to determine "how clean is clean enough" in the process of decommissioning. In making such an ascertainment, the NRC must first determine that public health, safety, and the environment are protected by ensuring that the total dose to an individual in the public from licensed operations is less than the public dose limit of 100 mrem/y. However, the NRC has set the goal for public doses attributable to residual contamination after decommissioning at a fraction of the public dose limit. In practice, decommissioning costs (as measured in terms of the cost of returning the lands and structures to unrestricted use) are balanced against the benefits of averting adverse health effects (as measured by dose reduction resulting from decontamination). The estimate of dose reduction is accomplished by first judging the potential future uses of the lands and structures as described by scenarios and then evaluating associated levels of radioactivity through modeling equations to arrive at a reasonable expectation of doses. The modeling and scenarios can become extremely complicated, depending on the level of detail required. Detailed modeling may often be beyond the technical and financial capabilities of a large number of licensees--especially for those licensees with limited scope and budgetary resources.

The purpose of this three-volume report is to provide generic and site-specific dose conversion factors for residual radioactivity that may be applied to a screening analysis to determine whether more detailed cost-benefit analyses must be performed. Briefly, Volume 1 presents the scenarios, models, mathematical formulations, assumptions, justification of parameter choices, and responses to comments from the January 1990 draft report published for comment. Volume 2 of this report is a micro-computer-based program, complete with a user's manual, tables of the generic dose conversion factors, example calculations developed to facilitate analyses, and computer code listing. The NRC staff plans to have the computer software distributed by the Energy Science and Technology Software Center, Oak Ridge National Laboratory, P.O. Box 1020, Oak Ridge, TN 37831-1020, telephone (615) 576-2606. Availability and instructions for procurement of the computer software will be announced in the Federal Register. Volume 3 is composed of sensitivity analyses of parameters used in the modeling and a comparison with previously used guidance, e.g., Regulatory Guide 1.86 (NRC 1974). These volumes will be published sequentially as they are developed.

All of over 22,000 NRC and NRC Agreement State licensees may use these dose conversion factors. In preparation for the development of release criteria to be used for decontamination of decommissioned lands and structures, the NRC has contracted the work in this report. This report will provide much of the technical basis for translating residual radioactivity into annual dose--measured in total effective dose equivalent.

The scenarios used are prudently conservative but not necessarily bounding or "worst case." Selection of a prudently conservative scenario requires a great deal of professional judgment and common sense. The intent is to account for the vast majority of potential uses of lands and structures and to overestimate the most probable annual dose while discounting a small fraction of highly unlikely uses that would result in higher doses. For example, a small fraction of higher doses could be imagined because of aberrant behavior or unpredictable and highly unlikely circumstances. The alternative was to use scenarios that would yield an upper limit on doses (i.e., bounding or "worst case") and would

unnecessarily limit the usefulness of the resulting release criteria without providing significantly increased benefits to the public health, the public safety, or the environment. Hence, the dose conversion factors in this report are judged to be higher than (i.e., overestimate) the most probable annual dose but may be lower than (i.e., underestimate) the bounding annual dose.

There is flexibility in the application of the modeling contained in this report. For example, if increased accuracy or realism of the screening dose conversion factors are desired, then with adequate justification the generic (default) parameter values may be replaced with site-specific parameters. Within the modeling framework of this report, such a substitution of parameters would lead to site-specific derived dose conversion factors. The site-specific dose conversion factors may then replace the generic dose conversion factors in the screening analysis.

Beyond the modeling and scope of this report, it is possible that a licensee may find it necessary to provide customized, site-specific modeling and optimization of radiation protection in accordance with the principles of maintaining exposures as low as reasonably achievable (ALARA) for decommissioning or the termination of a license. In such cases, some to none of the modeling framework in this report may be applicable. The hierarchy of the approaches for establishing dose conversion factors applied to residual radioactive contamination is illustrated in the following figure (page xvii).

As mentioned above, a draft of this report was issued for comment in early 1990. The summary of comments received on that draft and the NRC staff responses and resolutions are presented in Appendix A of this final report. This report is one part of a larger program the NRC staff has underway to provide information and guidance for the implementation of release criteria for the decommissioning of lands and structures. For example, NUREG/CR-5849, "Manual for Conducting Radiological Surveys in Support of License Termination" (Berger 1992), provides information on acceptable measurement and survey techniques and procedures. It is emphasized that the information in this report was developed for a screening application to the decommissioning of lands and structures and was not intended for other uses.

The NRC staff anticipates the need may arise to revise this report from time to time. Accordingly, comments noting suggested changes within the intended scope of this report are welcome and should be submitted in writing to the NRC Project Manager. The NRC Project Manager for this report may be contacted at the following address:

Dr. Robert A. Meck, Section Leader
Environmental Policy Section, RPHEB
Office of Nuclear Regulatory Research
U.S. Nuclear Regulatory Commission
Washington, D.C. 20555
(301) 492-7000

Hierarchy of Modeling Approaches

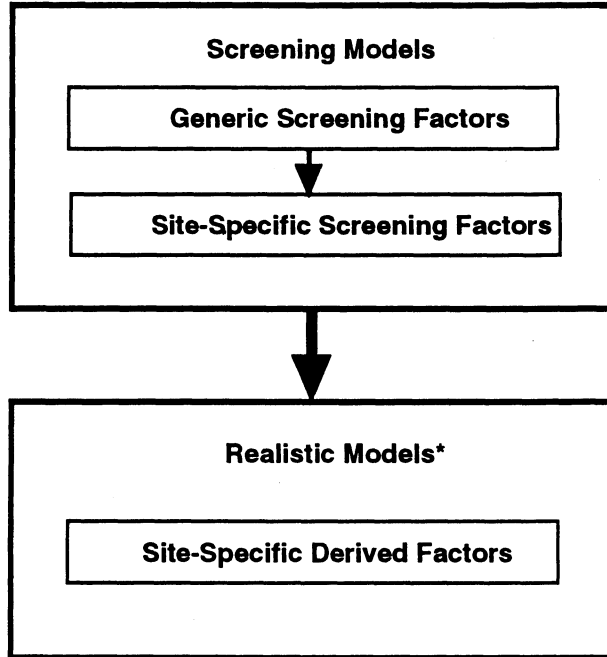

*Site-specific modeling in this box is outside the framework of modeling in this report.

NUREG/CR-5512 Modeling

Acknowledgments

This report represents the cumulative efforts of many individuals who contributed to its development, production, and publication over the past three years. We greatly appreciate the guidance, assistance, technical review, and encouragement provided by Dr. Donald A. Cool, Dr. R. A. Meck, Ms. Christine Daily, and the staff of the U.S. Nuclear Regulatory Commission (NRC); Dr. Marsha Sheppard of Atomic Energy of Canada Limited; Dr. Keith Eckerman of Oak Ridge National Laboratory; Dr. Charlie Yu of Argonne National Laboratory; Dr. David Layton and Dr. Lynn Anspaugh of Lawrence Livermore National Laboratory; Dr. Wayne Hansen of Los Alamos National Laboratory; and Mr. Jack Corley. We also would like to thank Jim Weber, Don Hanley, Joe Soldat, Gene Schreckhise, Dan Strom, Bill Templeton, Charlie Cole, Charlie Kincaid, David Baker, Paul Stansbury, Lissa Sawyer, Sandi Shindle, Rebecca Kennedy, plus all of the production team at Pacific Northwest Laboratory (PNL).

As a special note, the authors would like to gratefully mention the influence of the late Ed Watson (PNL) on this effort. In the late 1970s, under a previous NRC project designed to document the "Technology, Safety and Costs of Decommissioning," Ed was instrumental in forming the professional attitudes of the authors regarding the potential effects of exposure to residual radioactive contamination. His influence continued through the 1980s during the development of the "Allowable Residual Contamination Level" method for decommissioning U.S. Department of Energy facilities at the Hanford Site. Ed's influence has continued through the present work, and he is warmly remembered and sorely missed.

1 Introduction

The U.S. Nuclear Regulatory Commission (NRC) currently regulates the release of slightly radioactive property for unrestricted use through existing staff criteria. These NRC staff criteria are in two forms: 1) acceptable volumetric concentrations of source material in soil, provided in pCi/g first reported in the *Federal Register* in 1981 (46 FR 52061-3, 1981), and 2) acceptable levels of surface contamination, provided in units of dpm/100 cm² for average, maximum, and removable contamination conditions defined in Regulatory Guide 1.86 (NRC 1974). Both of these NRC staff criteria for release of slightly radioactive material have limitations. The criteria for volumetric concentrations in soil, for instance, are limited to the uranium and thorium chains of radionuclides and are applicable only to current contamination resulting from past operations. The NRC staff criteria governing surface contamination, although appropriate for all radionuclides, are often difficult to apply because of the wide variation in surface and volumetric contamination conditions and the varying mixture of radionuclides usually found in many licensed facilities. In addition, the values found in both sets of criteria are not consistent with the revised dosimetry system recommended by the International Commission on Radiological Protection (ICRP) in Publications 26 (1977), 30 (1979-1988), and 48 (1986), and provided by the U.S. Environmental Protection Agency (EPA) in Federal Guidance Report No. 11 (Eckerman, Wolbarst, and Richardson 1988).

To alleviate this situation, the NRC is developing a revised license termination policy to ensure an adequate and consistent level of protection for the public. As described in the Foreword, the revised policy will use models to form the basis for a screening analysis of the potential public doses from decommissioned lands and structures.

As a contribution to the development of revised guidance by the NRC, staff at the Pacific Northwest Laboratory (PNL) began the development in 1987 of a radiation exposure scenario/pathway modeling analysis to translate residual radioactive contamination levels into potential radiation doses to the public. The use of computerized models to conduct public dose assessments is typically necessary because of an inability to directly determine doses from numerous potential environmental pathways over long periods of time. The use of generic models and relatively simple data sets has become common for setting standards and regulations. For example, the NRC low-level radioactive waste regulations in 10 CFR 61 (1990) were developed with the use of generic models and data (Oztunali et al. 1981).

Historically, environmental-transfer and pathway-assessment models have been developed to consider a variety of different situations involving radioactive materials. Pathway-assessment models are commonly applied for radioactive waste management, accident assessment, and environmental impact statements. Example references involving various aspects of environmental radiological assessment include publications by Soldat and Harr (1971), the NRC (1977), the International Atomic Energy Agency (IAEA 1982), Till and Meyer (1983), Kennedy and Napier (1983), the National Council on Radiation Protection and Measurement (NCRP 1984), McKenzie et al. (1985), Kennedy et al. (1987), Strenge, Bander, and Soldat (1987), Napier et al. (1988), T. L. Gilbert et al. (1989), and O'Neal and Lee (1990). This report is largely based on these and numerous other previous pathway-assessment and data-collection efforts.

The development of models for screening to demonstrate compliance with environmental standards is the subject of Commentary No. 3 published by the National Council on Radiation Protection and Measurements (NCRP 1986). The NCRP presented three levels of screening for determining compliance with the regulations of the Clean Air Act, 40 CFR 61, National Emission Standards for Hazardous Air Pollutants; Standards for Radionuclides (50 FR 5190, 1985). In the NCRP approach, Level I applies the simplest models, including a high degree of conservatism with few parameter or data requirements. Levels II and III require additional site-specific data to reduce the modeling conservatism. If the user of the NCRP method shows compliance using the Level I models and data, then no further calculations are necessary. If the Level I results exceed the standards, the model user must apply the Level II and III

Introduction

models until compliance is determined. If the efforts fail at all levels, the NCRP recommends the use of professional assistance in radiological assessment to determine how to proceed (NCRP 1986).

This three-volume report provides information on the generic pathway/scenario analysis model used to derive the potential annual total effective dose equivalent (TEDE), or the TEDE as defined in 10 CFR 20 (56 FR 23360-23474, 1991) received during a year of scenario exposure, by an average individual in a given population group exposed to residual radioactive contamination. Volume 1 presents the detailed scenarios, models, mathematical formulations, assumptions, selected parameter values, and general responses to comments from the January 1990 comment draft. Volume 1 contains the level of detail needed to develop microcomputer-based, user-friendly software under strict quality-assurance procedures and is intended to be used as a reference to Volume 2. Volume 2 describes the software, including a user's manual, tables of generic unit-concentration annual TEDEs, example calculations developed to facilitate analyses, and the computer code listing. Volume 3 contains the results of a sensitivity analysis of parameter values used in the modeling and a comparison of the results with previously used guidance, e.g., Regulatory Guide 1.86 (NRC 1974). Volumes 2 and 3 will be published sequentially.

The methodology described in this report to calculate doses is consistent with the recommendations of the ICRP in Publication Nos. 26 (1977), 30 (1979-1988), and 48 (1986). The mathematical models described in this report are intended to be used for two levels of screening. The first level of screening relies on the use of default values for all parameter values and is intended to produce generic dose estimates that are unlikely to be exceeded at real sites. The degree of conservatism associated with the models and data is difficult to determine for a generic analysis. For the first level of screening, efforts have generally been made to select models that represent a variety of generic conditions and parameter values that lie within the distributions of reported or expected values (i.e., parameter values that are not at the extremes of the ranges). When this approach applies, the model and data selections are referred to as being "prudently conservative." The exceptions to this general approach are the model and data selections associated with the water-use model to account for potential ground-water contamination. For the water-use model, the model and parameter selections have been made in an intentionally conservative manner and are so noted in the text. For the first level of screening, portions of the modeling analysis are intentionally conservative. As a result, the annual TEDEs calculated using the default parameter values should provide an overestimate of the actual dose that individuals might receive. The second level of screening is accomplished using the computer software described in Volume 2, with the input of site-specific data to reduce the conservatism of the result and produce a more realistic estimate of site-specific conditions. This approach should produce results that will serve as an adequate basis for the development of generic screening criteria and should also be useful in determining when more detailed site-specific assessments or modifications to the generic scenarios are required. The models, pathways, scenarios, and parameters given here will be documented as a computer program in the next volume in this series. The computer program will enable the users to make simple modifications to the analysis to better consider site-specific conditions.

As with the NCRP screening models, the NRC will allow the application of a third level of screening to produce a more site-specific result. This third level would employ models and data that are carefully chosen to match the complex conditions at a specific site. Further discussion of this third level of screening is beyond the scope of this study.

To support the first two levels of this screening analysis, decisions have been made to define the scenarios, pathways, and default parameter values. Although these decisions are intended to focus the use of the models to address residual radioactive contamination in buildings and on land, they also limit the broader application of the models to more complex situations. These complex situations include sites with buried sources (as would be found at waste disposal sites), sites with existing ground-water plumes, sites with complex ground-water systems, and sites with the potential for high concentrations of indoor radon. For these situations, a more comprehensive site-specific modeling analysis should be performed within the third level of screening.

Two scenarios for residual radioactive materials in buildings are needed to adequately describe the potential contamination conditions found at actual facilities. These two scenarios account for 1) building renovation (subsurface or volume sources) and 2) normal building occupancy (surface contamination sources). Estimates of the potential dose from a subsurface inventory in the building renovation scenario are important to account for residual inventories of difficult-to-measure alpha-emitters or beta-emitters. The building occupancy scenario is intended to depict the situation where the residual inventory is present as a layer of surface contamination.

Two scenarios that rely on a generic water-use model are included for unrestricted use of land. The first scenario only considers drinking water from a ground-water source and accounts for the total radionuclide inventory at the site, in the soil, or in building materials that potentially may be demolished and disposed of onsite as buried rubble. The drinking water scenario is included to permit a comparison with the EPA drinking water standards. The drinking water scenario relates the annual TEDE in mrem per pCi (and μSv per Bq) of residual radioactive materials in soil. The second scenario considers residential use of land, including use of ground water for drinking and irrigation of farm products. The residential scenario relates the annual TEDE in units of mrem per pCi/g (and μSv per Bq/g) of soil. Because of the generic treatment of potentially complex ground-water systems, the water-use modeling is intentionally conservative. This means that the annual TEDE for the drinking water and residential scenarios may only indicate when additional site data or more sophisticated modeling are warranted. Using the software developed for this effort, again, modifications can be made to the scenarios for contaminated land to better account for site-specific soil contamination.

The purpose of this volume is to describe fully and document the scenarios, pathways, mathematical formulations, assumptions, and parameter values included in the generic analysis. Section 2 describes the basic methodology and nomenclature, including basic dosimetry definitions and listings of the notation used throughout the report. Section 3 describes the building renovation and building occupancy scenarios with a description of the conceptual models, time frames, and exposure pathways included and excluded from the analysis. Section 4 describes the generic water-use model and its application to the drinking water scenario. Section 5 describes the residential scenario, with a detailed description of the numerous agricultural pathways included in the analysis. Section 6 describes the selected parameter values used as defaults in the scenario analysis, including the basic dosimetry, radioactive decay, ground-water, and agricultural pathway parameters and data. Section 7 briefly describes the application of the information in this volume as it relates to Volumes 2 and 3 in the series. Finally, a series of appendixes are provided that include a summary of the comments received on the January 1990 draft version of this final report, extended nomenclature and methodology, the special ^{14}C and ^3H agricultural pathway models, and supplemental data.

2 Methodology and Nomenclature

This section contains information needed to understand the mathematical notation used in the building and soil scenario models. Definitions of dose and dose rate terms are provided in Section 2.1. The standard mathematical and operator notations used throughout the report are provided in Section 2.2. Appendix B contains extended nomenclature and methodology supporting this section, including the methods used for radioactive decay calculations.

2.1 Dosimetry Definitions

Because the purpose of this report is to provide the mathematical models and formulations needed to estimate radiation doses from residual radioactive contamination, it is important to understand the dosimetry terminology used. In most cases, terminology consistent with 10 CFR 20 (56 FR 23360-23474, 1991) is used. Additional definitions are supplied in the Glossary.

Dose or "radiation dose" - A generic term that means absorbed dose, dose equivalent, effective dose equivalent, committed dose equivalent, committed effective dose equivalent, or total effective dose equivalent, as defined below.

Absorbed dose - The energy imparted by ionizing radiation per unit mass of irradiated material. The units of absorbed dose are the rad and the gray (Gy).

Dose equivalent (H_T) - The product of the absorbed dose in tissue, quality factor, and all other necessary modifying factors at the location of interest. The units of dose equivalent are the rem and sievert (Sv).

Effective dose equivalent (H_E) - The sum of the products of the dose equivalent to the organ or tissue (H_T) and the weighting factors (w_T) applicable to each of the body organs or tissues that are irradiated ($H_E = \sum w_T H_T$).

Committed dose equivalent (H_{T50}) - The dose equivalent to organs or tissues of reference (T) that will be received from an intake of radioactive material by an individual during the 50-year period following intake.

Committed effective dose equivalent ($H_{E,50}$) - The sum of the products of the weighting factors applicable to each of the body organs or tissues that are irradiated (by internally deposited radionuclides) and the committed dose equivalent to these organs or tissues ($H_{E,50} = \sum w_T H_{T50}$).

Total effective dose equivalent (TEDE) - The sum of the deep dose equivalent (for external exposures) and the committed effective dose equivalent (for internal exposures).

Deep dose equivalent (H_d) - Applied to external whole-body exposure, H_d is the dose equivalent at a tissue depth of 1 cm (1000 mg/cm²). (Note: for this generic application, the TEDE is calculated using the external effective dose equivalent, provided in dose conversion factors from EPA, as described in Section 6.)

Annual total effective dose equivalent (annual TEDE) - The total effective dose equivalent (TEDE) received during a year of scenario exposure. The duration of exposure for each pathway is determined by the scenario considered and need not be 8766 h/y. For example, an individual may reside or work at a contaminated site for only a fraction of the year.

Nomenclature

In general, the results produced by the scenarios considered in this report are expressed as annual TEDEs to denote that a year of scenario exposure has been considered. This notation is used to ensure the definition and use of consistent units for all of the scenario and pathway equations in this report.

2.2 Symbol Nomenclature

The mathematical models described in this report involve many equations with numerous parameters. Because of the complexity of the equations, a system of nomenclature has been developed to represent symbols used for the parameters. This system of nomenclature is summarized in this section for ease of reference to understand the mathematical formulations that follow. Parameters are defined again when they are first used within each section. The system of nomenclature includes a definition of units used to permit a full dimensional analysis.

The parameter definitions are divided into three parts: dosimetric parameters (Table 2.1), subscripted parameters (Table 2.2), and parameters without subscripts (Table 2.3). In general, terms beginning with "D" are dose or dose rate factors; "TEDE" are annual total effective dose equivalents; "AF" are ingestion-pathway committed effective dose equivalent factors; "C" are concentrations (per unit mass, volume, or area), or total activity of a radionuclide, as appropriate; and " λ " are radioactive decay rate constants. General subscripts encountered include "i" or "j" for parent or decay-chain-member radionuclides; "s" for soil; "w" for water; and "v" for food crops (agricultural pathways).

In addition to the parameters listed in the tables, a special notation is used for radioactive decay calculations. Decay operators are represented by A {}, S {}, R {}, and G {}, as defined in Appendix B:

A {} = changes in parent and progeny activities or concentrations over time (i.e., radioactive decay and ingrowth)

S {} = time integrals of activity or concentration

R {} = accumulation of deposited activity over a time period

G {} = deposition, accumulation, and time-integration of a constant deposition rate (used for deposition from irrigation water onto plants).

The operations are performed on an initial array of chain member activities or concentrations for a specific time period. For example, the decay calculation is represented as follows:

$$A\{C_*, t_*\} \quad (2.1)$$

where A {} = the operation of decay calculation (in appropriate units)

C_* = the array of chain member activities or concentrations (in appropriate units)

t_* = time period over which the decay occurs (in time units).

Table 2.1 Dosimetry parameters

Symbol	Definition
Agricultural water-use dose factors	
AF_{dj}	Dose contribution from drinking water contaminated by radionuclide j, expressed as committed effective dose equivalent per unit average concentration of radionuclide j in water (mrem per pCi/L for a year of residential scenario)
AF_{fj}	Dose contribution from aquatic food products contaminated by radionuclide j in water, expressed as committed effective dose equivalent per unit average concentration of radionuclide j in water (mrem per pCi/L for a year of residential scenario)
AF_{sj}	Dose contribution from agricultural products contaminated by radionuclide j in soil, expressed as committed effective dose equivalent per unit initial concentration of radionuclide j in soil at the start of a growing season (mrem per pCi/g for a year of residential scenario)
AF_{wj}	Dose contribution from agricultural products contaminated by irrigation with ground water for radionuclide j, expressed as committed effective dose equivalent per unit average concentration of radionuclide j in water (mrem per pCi/L for a year of residential scenario)
Dose factors for building renovation scenario	
$DEXB_i$	External dose for parent radionuclide i for one renovation work period in 1 year (mrem)
DGB_i	Committed effective dose equivalent from ingestion for parent radionuclide i for one renovation work period in 1 year (mrem)
DHB_i	Committed effective dose equivalent from inhalation for parent radionuclide i for one renovation work period in 1 year (mrem)
$TEDEB_i$	Annual total effective dose equivalent for parent radionuclide i (mrem for renovation work in a year, with an initial inventory in units of pCi/g)
$TEDEB_{iSI}$	Annual total effective dose equivalent for parent radionuclide i (μ Sv for renovation work in a year, with an initial inventory in units of Bq/g)
$TEDEB_m$	Annual total effective dose equivalent for the mixture of radionuclides (mrem for renovation work in a year, with an initial inventory in units of pCi/g)
Dose factors for building occupancy scenario	
$DEXO_i$	External dose for parent radionuclide i for 1 year of building occupancy (mrem)
DGO_i	Committed effective dose equivalent from ingestion for parent radionuclide i for 1 year of building occupancy (mrem)

Table 2.1 Dosimetry parameters (Continued)

Symbol	Definition
DHO_i	Committed effective dose equivalent from inhalation for parent radionuclide i for 1 year of building occupancy (mrem)
$TEDEO_i$	Annual total effective dose equivalent for parent radionuclide i (mrem for a year of building occupancy, with an initial inventory in units of dpm/100 cm ²)
$TEDEO_{iSI}$	Annual total effective dose equivalent for parent radionuclide i (μ Sv for a year of building occupancy, with an initial inventory in units of Bq/100 cm ²)
$TEDEO_m$	Annual total effective dose equivalent for a mixture of radionuclides (mrem for a year of building occupancy, with an initial inventory in units of dpm/100 cm ²)
Dose factors for drinking water scenario (for year of highest TEDE)	
$HOCDE_i$	Highest annual organ committed dose equivalent for parent radionuclide i from ingestion of drinking water (mrem for a year of drinking water with an initial inventory in units of pCi)
$HOCDE_{iSI}$	Highest annual organ committed dose equivalent for parent radionuclide i from ingestion of drinking water (μ Sv for a year of drinking water with an initial inventory in units of Bq)
$HOCDE_m$	Highest annual organ committed dose equivalent for a mixture of radionuclides m from ingestion of drinking water (mrem for a year of drinking water with an initial inventory in units of pCi)
$HOCDE_{mSI}$	Highest annual organ committed dose equivalent for a mixture of radionuclides m from ingestion of drinking water (μ Sv for a year of drinking water with an initial inventory in units of Bq)
$TEDED_i$	Annual total effective dose equivalent for the drinking water scenario for parent radionuclide i (mrem for a year of drinking water, with an initial inventory in units of pCi)
$TEDED_{iSI}$	Annual total effective dose equivalent for the drinking water scenario for parent radionuclide i (μ Sv for a year of drinking water, with an initial inventory in units of Bq)
$TEDED_m$	Annual total effective dose equivalent for the drinking water scenario for a mixture of radionuclides m (mrem for a year of drinking water, with an initial inventory in units of pCi)
Dose factors for residential scenario (for year of highest annual TEDE)	
DAR_i	Committed effective dose equivalent from ingestion of aquatic foods for parent radionuclide i (mrem for a year of residential scenario)
$DEXR_i$	External dose for parent radionuclide i (mrem for a year of residential scenario)
DGR_i	Committed effective dose equivalent from ingestion for intake of home-grown food and animal products for parent radionuclide i (mrem for a year of residential scenario)

Table 2.1 Dosimetry parameters (Continued)

Symbol	Definition
DHR_i	Committed effective dose equivalent from inhalation of airborne soil and house dust for parent radionuclide i (mrem for a year of residential scenario)
DSR_i	Committed effective dose equivalent from ingestion of soil for parent radionuclide i (mrem for a year of residential scenario)
DWR_i	Committed effective dose equivalent from ingestion of drinking water and irrigated food for parent radionuclide i (mrem for a year of residential scenario)
$TEDER_i$	Annual total effective dose equivalent for parent radionuclide i (mrem for a year of residential scenario, with an initial inventory in units of pCi/g)
$TEDER_{iSI}$	Annual total effective dose equivalent for parent radionuclide i (μ Sv for a year of residential scenario, with an initial inventory in units of Bq/g)
$TEDER_m$	Annual total effective dose equivalent for a mixture of radionuclides m (mrem for a year of residential scenario with an initial inventory in units of pCi/g)
General dose factors for description of implicit progeny handling	
DF_i	Internal or external factor for the parent radionuclide i as taken from the database (in appropriate units for the dose factor type)
DF_j	Internal or external dose factor for the short-lived radionuclide j as taken from the database (in appropriate units for the dose factor type)
DFC_i	Internal or external combined dose factor for the parent radionuclide i (in appropriate units for the dose factor type)
Basic dose factors from database (after units conversion)	
$DFER_j$	External dose rate factor for radionuclide j from contamination uniformly distributed in the top 15 cm of residential soil or building material (mrem/h per pCi/g)
$DFES_j$	External dose rate factor for radionuclide j from contamination uniformly distributed on surfaces (mrem/h per dpm/100 cm ²)
DFG_j	Committed effective dose equivalent from ingestion of radionuclide j (mrem per pCi ingested)
DFH_j	Committed effective dose equivalent from inhalation for radionuclide j from contaminated air (mrem per pCi inhaled)
DFO_{jo}	Committed dose equivalent to organ o from ingestion of radionuclide j (mrem per pCi ingested)

Nomenclature

Table 2.2 Subscripted parameter summary

<u>Parameter</u>	<u>Number of subscripts</u>	<u>Order of subscripts</u>	<u>Description</u>
A	3		Concentration of radionuclides for the current year per initial unit concentration of parent radionuclide i in soil
		1	s - soil (pCi/g per pCi/g)
		2	w - water (pCi/L per pCi/g)
		3	t - current year
			i - parent
			j - chain member (1 for parent, >1 for progeny)
A _d	1		Area of land contaminated in the drinking water scenario (m ²)
A _j	1		Activity of radionuclide j (pCi)
A _r	1		Area of land contaminated in the residential scenario (m ²)
A _{ij}	2		Concentration of radionuclide j present at the beginning of the current 1-year exposure period, t, per initial concentration of parent radionuclide i (pCi/g per pCi/g in soil)
AF (see Table 2.1)			
B	2		Concentration factor for uptake of a radionuclide from soil to edible parts of a plant (pCi/kg dry-weight plant per pCi/kg dry-weight soil)
		1	i - parent radionuclide
			j - chain member (1 for parent, >1 for progeny)
		2	f - forage crop
			g - stored grain crop
			h - stored hay crop
			v - food crop
BA	2		Bioaccumulation factor for transfer of activity from water to edible parts of fish (pCi/kg wet-weight fish per pCi/L water)
		1	i - parent radionuclide
			j - chain member (1 for parent, >1 for progeny)
		2	f - aquatic foods (fish)

Table 2.2 Subscripted parameter summary (Continued)

<u>Parameter</u>	<u>Number of subscripts</u>	<u>Order of subscripts</u>	<u>Description</u>	
C	2	1	Activity or concentration in a medium	
			b - medium is building renovation material (pCi/g)	
			k - medium is box k of water-use model	
			o - medium is building surface material (dpm/100 cm ²)	
			r - medium is residential soil (pCi/g)	
			s - medium is soil (pCi/g)	
			t - total activity in soil (pCi)	
			w - medium is water (pCi/L)	
			v - medium is vegetation (pCi/g dry-weight plant)	
			1 - total activity in box 1 of water-use model (pCi)	
			2 - total activity in box 2 of water-use model (pCi)	
			3 - total activity in box 3 of water-use model (pCi)	
			2	i - parent radionuclide
				j - chain member (1 for parent, >1 for progeny)
C - carbon-14				
H - tritium				
C	4	1	Activity or concentration factor for transfer from a contaminating medium (e.g., soil or water) to a receiving medium of consumption (e.g., soil, food, or water)	
			Contaminating medium (units of denominator of C)	
			s - medium is soil (pCi/g or total pCi for the drinking water scenario)	
			r - root uptake from irrigation to the soil path (pCi/L)	
			w - medium is water (pCi/L)	
			2	Receiving medium (units of numerator of C)
				a - animal product (pCi/kg wet weight)
				f - forage crop (pCi/kg wet weight)
				g - stored grain crop (pCi/kg wet weight)
				h - stored hay crop (pCi/kg wet weight)
				s - soil (pCi/kg dry-weight soil)
				v - food crop (pCi/kg wet weight)
			w - drinking water (pCi/L)	
			3	i - parent radionuclide
				j - chain member (radionuclide, parent or progeny)
				C - carbon-14
				H - tritium

Nomenclature

Table 2.2 Subscripted parameter summary (Continued)

<u>Parameter</u>	<u>Number of subscripts</u>	<u>Order of subscripts</u>	<u>Description</u>
C	4	4	c - evaluated at time of general feed consumption by animals d - animal ingestion of dirt (soil) at time of forage consumption f - evaluated at point when animals begin consuming forage h - evaluated at point when harvesting of food begins p - evaluated at point when people start consuming the food s - evaluated at point when animals start consuming stored food t - evaluated for the year t, or at any time t w - evaluated over time of water consumption by animals y - evaluated for a 1-year time period
C_{soil}			Ratio of the ^{14}C concentration in soil eaten by animal to the initial concentration of ^{14}C in the soil, with units conversion from grams to kilograms (g/kg)
CR_v			Effective concentration ratio between soil and plant type v (pCi/g dry-weight plant per pCi/g dry-weight soil)
d_{pj}	2		Fraction of radionuclide p transitions that result in production of radionuclide j (dimensionless)
d_s	1		Density of agricultural soil (g/cm^3)
DEXB, DEXO, DEXR (see Table 2.1)			
DF, DFC, DFER, DFES, DFEV, DFG, DFH (see Table 2.1)			
DGB, DGO, DGR (see Table 2.1)			
DHB, DHO, DHR (see Table 2.1)			
DSR, DWR (see Table 2.1)			
F	2		Transfer coefficient relating daily intake in animal feed or ingested soil to concentration in edible animal product
		1	a - food type (animal product)
		2	j - chain member (radionuclide, parent, or progeny)

Table 2.2 Subscribed parameter summary (Continued)

<u>Parameter</u>	<u>Number of subscripts</u>	<u>Order of subscripts</u>	<u>Description</u>
f_r	1		Fraction of water removed from Box 3 that is deposited on the surface layer by irrigation
f	1		1 - surface-soil layer, box 1 2 - unsaturated-soil layer, box 2
f	2	1	Fraction, by weight, of carbon or hydrogen in a medium (dimensionless) C - carbon H - hydrogen
		2	a - medium is an animal product d - medium is soil (dirt) f - medium is fresh forage g - medium is stored grain h - medium is stored hay v - medium is food crop
H	1	1	Assumed thickness of soil layers for water-use model(m) 1 - surface-soil layer, box 1 2 - unsaturated-soil layer, box 2
J_i			Number of radionuclides in decay chain for parent radionuclide i
K	2	1	Coefficient in chain decay equations (pCi•d) n - precursor chain members j - current chain member
		2	j - current chain member
K_d	2	1	Partition coefficient for radionuclide i, defined by element and box (mL/g) Water-use model box 1 - surface-soil, box 1 2 - unsaturated layer, box 2
		2	Radionuclide index i - parent radionuclide j - chain member radionuclide (parent or progeny)
L	3	1	Rate constant for movement of radionuclides between boxes of the water-use model (d^{-1}) 1 - transfer from box 1 2 - transfer from box 2
		2	2 - transfer to box 2 3 - transfer to box 3
		3	i - parent radionuclide j - chain member radionuclide (1 for parent or >1 for progeny)

Nomenclature

Table 2.2 Subscribed parameter summary (Continued)

<u>Parameter</u>	<u>Number of subscripts</u>	<u>Order of subscripts</u>	<u>Description</u>
ML	1	1	Plant soil mass-loading factor for transfer from soil to plants (pCi/kg dry-weight plant per pCi/kg dry-weight soil) f - forage crops g - stored grain crops h - stored hay crops v - food crops
n	1	1	The porosity of the soil layers (dimensionless) 1 - surface-soil layer, box 1 2 - unsaturated-soil layer, box 2
N _d			Number of short-lived progeny for which contributions are to be included with the parent radionuclide dose factors
N _v			Total number of food products considered in the diet
P	1	1	Soil areal density s - areal soil density in agricultural areas (kg dry-weight soil/m ²) d - floor dust-loading for residential scenario (g/m ²)
PPTF	4	1	Partial pathway transfer factors (PPTFs) providing activity time integral in a food type (pCi•y/unit receiving medium per unit initial activity in a contaminating medium) Receiving medium a - animal product type v - food crop type
		2	Contaminating medium s - soil w - water
		3	Parent radionuclide index i - parent radionuclide C - carbon-14 H - tritium
		4	Progeny radionuclide index j - chain member (1 for parent, >1 for progeny) "blank" - 4th subscript not used for carbon-14 or tritium
PF	3	1	Pathway transfer factors (PFs) providing intake (pCi) by humans per unit initial concentration in a medium s - medium is soil w - medium is water
		2	i - parent radionuclide
		3	j - chain member (1 for parent, >1 for progeny)

Table 2.2 Subscripted parameter summary (Continued)

<u>Parameter</u>	<u>Number of subscripts</u>	<u>Order of subscripts</u>	<u>Description</u>
Q	1	1	Consumption rate by animal d - animal ingestion of soil (dirt) (kg dry-weight soil per kg dry-weight forage) f - forage crop (kg wet-weight forage/d) g - stored grain crop (kg wet-weight grain/d) h - stored hay crop (kg wet-weight hay/d) w - water (L/d)
		2	Amount of radionuclide present (units proportional to atoms) 1 - medium is surface-soil (box 1) 2 - medium is unsaturated zone (box 2) 3 - medium is ground-water aquifer (box 3) m - general medium 2 1 - parent radionuclide 2 - first progeny radionuclide (chain member 2) 3 - second progeny radionuclide (chain member 3) i - parent radionuclide j - chain member (1 for parent, >1 for progeny)
r	1	1	Fraction of initial deposition retained on the plant from irrigation water f - forage crop g - stored grain crop h - stored hay crop v - food crop
R	4	1	Deposition rate from irrigation water to a medium Deposition pathway w - water to plant surfaces or soil
		2	Medium receiving deposition f - forage crop type g - stored grain crop h - stored hay crop s - soil v - food crop
		3	Radionuclide index i - parent radionuclide j - chain member (1 for parent, >1 for progeny)
		4	Period of deposition g - crop-growing period f - animal-foraging period

Table 2.2 Subscripted parameter summary (Continued)

<u>Parameter</u>	<u>Number of subscripts</u>	<u>Order of subscripts</u>	<u>Description</u>
RF	1	1	Resuspension factor (m^{-1}) o - building occupancy scenario r - indoor activity for residential scenario
R_t	2	1	Retardation factor (dimensionless) 1 - surface-soil layer, box 1 2 - unsaturated-soil layer, (box 2)
		2	j - current chain member
SA	3	1	Specific activity equivalence factors for carbon and tritium s - medium is soil T - normalized to total activity w - medium is water
		2	a - animal product v - crop
		3	C - carbon-14 H - tritium
t	1	1	Time period (d) b - time spent in building renovation work d - water intake period for drinking water scenario f - fish intake period for residential scenario g - time spent gardening for residential scenario i - time spent indoors for residential scenario o - time spent in building occupancy r - time of residential scenario x - time spent outdoors for residential scenario y - 1 year

Table 2.2 Subscripted parameter summary (Continued)

<u>Parameter</u>	<u>Number of subscripts</u>	<u>Order of subscripts</u>	<u>Description</u>
t	2	1	Time period (d) c - consumption period by humans f - feeding period for animals producing animal product a g - crop-growing period h - time between harvest and consumption by humans t - total elapsed time for a period w - consumption period for animals drinking contaminated water
		2	a - animal product b - building renovation scenario d - drinking water scenario f - forage crop g - gardening period (used only with first subscript t) g - stored grain crop (used only with first subscript g or f) h - stored hay crop o - building occupancy scenario r - residential scenario s - stored feed (hay or grain) v - food crop
T	1	1	Translocation factor of activity from plant surfaces to edible parts of the plant (dimensionless) f - forage crop g - stored grain crop h - stored hay crop v - food crop
TEDEB, TEDED, TEDEO, TEDER (see Table 2.1)			
U	1	1	Ingestion rate of foods or water by humans a - animal product (kg/y) f - aquatic food, fish (kg/y) v - food crop (kg/y) w - drinking water (L/d)
V	1	1	Volumetric breathing rate (m ³ /h) b - building renovation scenario g - residential scenario, gardening r - residential scenario, indoors o - building occupancy scenario s - standard rate used as the basis for the inhalation dose factors (DHF) x - residential scenario, outdoors

Nomenclature

Table 2.2 Subscripted parameter summary (Continued)

<u>Parameter</u>	<u>Number of subscripts</u>	<u>Order of subscripts</u>	<u>Description</u>
V_{dd}			Volume of water used for domestic purposes during a year of drinking water scenario (L)
V_{dr}			Volume of water used for domestic purposes during a year of residential scenario (L)
V_{ld}			Volume of water infiltrating through contaminated area in a year for the drinking water scenario water-use model (L)
V_{lr}			Volume of water infiltrating through contaminated area in a year for the residential scenario water-use model (L)
V_{irr}			Volume of water used for irrigation during a year of residential scenario (L)
V_{sw}			Volume of water in the surface-water pond used in production of aquatic foods (L)
V_{Td}			Total aquifer volume for the drinking water scenario (L)
V_{Tr}			Total aquifer volume for the residential scenario (L)
w	1	1	removal rate constant for the water-use models (d^{-1}) d - drinking water scenario r - residential scenario
W	1	1	Factor to convert plant concentrations from a dry-weight basis to a wet-weight basis (kg dry-weight plant per kg wet-weight plant) f - forage crop g - stored grain crop h - stored hay crop v - food crop
x	1	1	Fraction of animal feed or water intake that is contaminated, defined for each animal type f - forage g - stored grain h - stored hay w - water

Table 2.2 Subscripted parameter summary (Continued)

<u>Parameter</u>	<u>Number of subscripts</u>	<u>Order of subscripts</u>	<u>Description</u>
Y	1	1	Yield of crop (kg wet weight per m ²) f - forage crop g - stored grain crop h - stored hay crop v - food crop
θ	1	1	Volumetric water content for a soil layer (dimensionless) 1 - surface-soil layer 2 - unsaturated-soil layer
ρ	1	1	Bulk density for a soil layer (g/mL) 1 - surface-soil layer 2 - unsaturated-soil layer
λ_{nj}			Decay rate constant for transition of radionuclide n to radionuclide j (d ⁻¹)
λ	2	1	Rate constant (d ⁻¹) w - removal by weathering from plant surfaces e - effective (sum of removal and decay rate constants) r - radiological decay
		2	i - parent radionuclide j - chain member (1 for parent, >1 for progeny) n - chain member "blank" - not dependent on radionuclide

Nomenclature

Table 2.3 Unsubscripted parameters

Symbol	Definition
A	Area of land under irrigated agricultural production (m^2)
CDB	Dust-loading for building renovation work (g/m^3)
CDG	Dust-loading for gardening activities (g/m^3)
CDI	Dust-loading for indoor exposure periods (g/m^3)
CDO	Dust-loading for outdoor exposure periods (g/m^3)
DIET	Fraction of annual diet derived from home-grown foods (dimensionless)
DL	Annual dose limit for evaluation of the potential for adverse impacts (mrem)
F	Dilution flow in the ground-water aquifer (L)
GB	Effective transfer rate for ingestion of loose dust transferred from building surfaces to hands and mouth during building renovation work (g/h)
GO	Effective transfer rate for ingestion of removable surface activity transferred from surfaces to hands and mouth during building occupancy (m^2/h)
GR	Effective transfer rate for ingestion of soil and dust transferred to the mouth during the residential scenario (g/d)
H*	Absolute humidity (L/m^3)
i	Index of parent radionuclide
j	Index of current chain member position in decay chain
k	Proportionality constant to convert from activity units to atom units, dependent on the activity units used, equal for all radionuclides ($k = 1$ when activity is given in Bq and λ_{ij} in inverse seconds)
I	Infiltration rate (m/y)
IR	Annual average application rate of irrigation water ($L/m^2 \cdot d$)
M	Number of parent radionuclides in the mixture
QT	Total activity factor for irrigated land (pCi per pCi/g)

Table 2.3 Unsubscripted parameters (Continued)

Symbol	Definition
SFI	Shielding factor by which external dose rate is reduced during periods of indoor residence (dimensionless)
SFO	Optional shielding factor by which external dose rate is reduced during periods of outdoor residence (dimensionless)
SH	Moisture content of soil (L/kg)

The units of the decay operator are the same as those of the initial activity or concentration array. The asterisk subscript represents possibilities defined for activities or concentrations (parameters C in Table 2.2) and time (parameter t in Table 2.2). The time integral of activity or concentration, S{ }, must be evaluated in several of the models. The nomenclature of this operator is the same as that for the decay operator, A{ }:

$$S\{C_*,t_*\} \quad (2.2)$$

where S{ } = the operation of time-integration calculation (in appropriate units)

C_{*} = the array of chain member activities (in appropriate units)

t_{*} = time period over which the integration is performed (in time units).

Units of the resulting operation are the product of the activity or concentration units and the time units. For example, evaluation of a time integral of activity in pCi for a time period in days would provide results in units of pCi • d.

The operator for evaluation of the concentration in a medium after accumulation of constantly depositing activity is represented as

$$R\{R_*,t_*\} \quad (2.3)$$

where R{ } = the operation of the deposition, accumulation calculation (in appropriate units)

R_{*} = the array of chain member constant deposition rates (in appropriate units per unit time)

t_{*} = time period over which the deposition at a constant rate occurs (in time units).

Units of the resulting operation are the same as the receiving medium units, which are the units of the deposition rate multiplied by time. For example, if the deposition rate is defined as pCi/d per kg of plant and time units are in days, then the resulting units are pCi/kg of plant. Note that the time units for the deposition rate and the time parameter must be the same (or a time units conversion factor must be applied to the result).

The deposition, accumulation, and time-integration operator is needed for processes involving deposition (via irrigation water) for the residential scenario. This operator is used to evaluate the activity or concentration in a

Nomenclature

medium after deposition for a period of time. The deposition, accumulation, and time-integration operator is represented as:

$$G\{R_*, t_*\} \quad (2.4)$$

where $G\{\}$ = the operation of the deposition, accumulation, and time-integration calculation (in appropriate units)

R_* = the array of chain members with constant deposition rates (in appropriate units per unit time)

t_* = the time period over which the deposition, accumulation, and time-integration calculation is performed (in time units).

Units of the resulting operation are the product of the activity or concentration-per-time units and the square of the time units. For example, evaluation of a time integral of deposition rate in pCi/day for a time period in days would provide results with units of pCi•d. Note that the resulting units are the same as those for the single time-integral of activity or concentration. The deposition, accumulation, and time-integration operator results may be divided by the integration time period to give an average concentration or activity over the period.

A summary of the various uses of the decay and time-integral operators used in this report is given in Table 2.4. The table provides references to specific equations in Appendix B and to the form of the exponential term in the equations. Each application involves use of a summation equation that includes the product of coefficients multiplied by an exponential term as follows:

$$(\text{Operator Value})_j = \sum_{n=1}^j (\text{Coefficient})_n (\text{Exponential Term})_n \quad (2.5)$$

Where the subscript, j , refers to a chain member and the subscript, n , refers to all precursor radionuclide positions in the decay chain. The form of the exponential term depends on the application (as indicated in Table 2.4).

Using the indicated equations, specific equations for the operators can be developed. Examples of generation of specific equations from the general equations are given in Appendix B.

The drinking water scenario involves a special application of the decay and time-integral operators. This application involves generation of a solution to the three-box water-use model. Details of the water-use model applications are provided in Section 4 (drinking water scenario) and Section 5 (residential scenario). A summary of the operator notation for the water-use model is given in Table 2.5. The drinking water scenario application uses the basic equations including removal terms in Equations (B.15 to B.18). The residential scenario application is described in Section B.7.

Table 2.4 Summary of operator notation equations

Operator	Summation Equation	Coefficient Equations	Exponential Term	Calculation
$A\{C_{\bullet}, t_{\bullet}\}$	B.2	B.3-B.5	$\exp(-\lambda_{ej} t_{\bullet})$	Decay for a time period
$A_e\{C_{\bullet}, t_{\bullet}\}$	B.15	B.16-B.18	$\exp(-\lambda_{ej} t_{\bullet})$	Decay with removal for a time period
$S\{C_{\bullet}, t_{\bullet}\}$	B.2	B.3-B.5	$[1-\exp(-\lambda_{ej} t_{\bullet})]/\lambda_{ej}$	Time integral over a time period
$S_e\{C_{\bullet}, t_{\bullet}\}$	B.15	B.16-B.18	$[1-\exp(-\lambda_{ej} t_{\bullet})]/\lambda_{ej}$	Time integral with removal over a time period
$R\{R_{\bullet}, t_{\bullet}\}$	B.2	B.3-B.5	$[1-\exp(-\lambda_{ej} t_{\bullet})]/\lambda_{ej}$	Deposition and accumulation of a constant deposition rate over a time period
$R_e\{R_{\bullet}, t_{\bullet}\}$	B.15	B.16-B.18	$[1-\exp(-\lambda_{ej} t_{\bullet})]/\lambda_{ej}$	Deposition and accumulation of a constant deposition rate with removal over a time period
$G\{R_{\bullet}, t_{\bullet}\}$	B.2	B.3-B.5	$\{t-[1-\exp(-\lambda_{ej} t_{\bullet})]/\lambda_{ej}\}/\lambda_{ej}$	Deposition, accumulation, and time-integration of a constant deposition rate over a time period
$G_e\{R_{\bullet}, t_{\bullet}\}$	B.15	B.16-B.18	$\{t-[1-\exp(-\lambda_{ej} t_{\bullet})]/\lambda_{ej}\}/\lambda_{ej}$	Deposition, accumulation, and time-integration of a constant deposition rate with removal over a time period

As an example of the use of the decay operator, the concentration of radionuclide j in building materials after decay during the renovation work period, t_{tb} , is calculated from the initial concentration in building materials, C_{bj} , and is written

$$A\{C_{bj}, t_{tb}\} \quad (2.6)$$

The time integral of the concentration in building material of radionuclide j over this period is written

$$S\{C_{bj}, t_{tb}\} \quad (2.7)$$

Table 2.5 Summary of water-use model operator notation equations

Operator	Summation Equation	Coefficient Equations	Exponential Term	Calculation
$A_{dk}\{C_*, t_*\}$	B.15	B.16-B.18	$\exp(-\lambda_{ej} t_*)$	Decay for a time period in drinking water scenario water-use model box k
$A_{rk}\{C_*, t_*\}$		(see Section B.7)		Decay with removal for a time period in residential scenario water-use model box k
$S_{dk}\{C_*, t_*\}$	B.15	B.16-B.18	$[1-\exp(-\lambda_{ej} t_*)]/\lambda_{ej}$	Time integral over a time period in drinking water scenario water-use model box k
$S_{rk}\{C_*, t_*\}$		(see Section B.7)		Time integral with removal over a time in residential scenario water-use model box k

Multiple applications of the decay or time-integral operations are represented as nested symbols. For example, the decay of radionuclide j concentration in soil, for a time t_{tb} , followed by a time integration for a period t_y , is represented as follows:

$$S\{A\{C_{sj}, t_{tb}\}, t_y\} \tag{2.8}$$

The decay operator notation can be expanded using equations given in Appendix B. The expansion will result in one equation for each chain member, giving the desired parameter value as indicated for the specific operator. For example, Equation (2.6) can be written for a two-membered decay chain as two equations, one for the parent and one for the first progeny.

The explicit equations are as follows:

for the parent,

$$C_{b1}(t_{tb}) = C_{b1}(0) e^{-\lambda_{r1}t_{tb}} \tag{2.9}$$

and for the first progeny,

$$C_{b2}(t_{tb}) = \frac{\lambda_{r2}d_{12}C_{b1}(0)}{\lambda_{r2} - \lambda_{r1}} e^{-\lambda_{r1}t_{tb}} + \left[C_{b2}(0) - \frac{\lambda_{r2}d_{12}C_{b1}(0)}{\lambda_{r2} - \lambda_{r1}} \right] e^{-\lambda_{r2}t_{tb}} \tag{2.10}$$

where $C_{b1}(t_{tb})$ = concentration of parent radionuclide in building material evaluated at time t_{tb} (activity units)

$C_{b2}(t_{tb})$ = concentration of first progeny radionuclide in building material evaluated at time t_{tb} (activity units)

$C_{b1}(0)$ = initial concentration of parent radionuclide in building material (activity units)

$C_{b2}(0)$ = initial concentration of first progeny radionuclide in building material (activity units)

λ_{r1} = radioactive decay rate constant for the parent radionuclide (d^{-1})

λ_{r2} = radioactive decay rate constant for the progeny radionuclide (d^{-1})

d_{12} = the fraction of parent radionuclide transitions that result in production of progeny radionuclide (dimensionless)

t_{tb} = duration of the renovation period

and other terms are as previously defined.

The time-integral operator notation can also be expanded directly from Equations (2.9) and (2.10) by integrating the expressions over time between 0 and t_{tb} . Noting that, for any radionuclide j ,

$$\int_0^{t_{tb}} e^{-\lambda_{rj}t} dt = \frac{[1 - e^{-\lambda_{rj}t_{tb}}]}{\lambda_{rj}} \quad (2.11)$$

the results are as follows for the parent radionuclide:

$$\int_0^{t_{tb}} C_{b1}(t) dt = C_{b1}(0) [1 - e^{-\lambda_{r1}t_{tb}}] / \lambda_{r1} \quad (2.12)$$

and for the first progeny,

$$\int_0^{t_{tb}} C_{b2}(t) dt = \left[\frac{\lambda_{r2}d_{12}C_{b1}(0)}{\lambda_{r2} - \lambda_{r1}} [1 - e^{-\lambda_{r1}t_{tb}}] / \lambda_{r1} \right] + \left[C_{b2}(0) - \frac{\lambda_{r2}d_{12}C_{b1}(0)}{\lambda_{r2} - \lambda_{r1}} \right] [1 - e^{-\lambda_{r2}t_{tb}}] / \lambda_{r2} \quad (2.13)$$

3 Scenario Descriptions for the Release of Buildings

Currently, there are estimated to be over 22,000 NRC and NRC Agreement State licensees that will eventually apply for license termination. There is a significant diversity in the types of buildings and building materials to be released after decommissioning. For example, licensed facilities range from commercial nuclear power reactors to research laboratories at universities and industrial plants. Because licensed facilities are in commercial use, it is unlikely that continuous exposure (i.e., 24 h/d) could occur after license termination. Therefore, the conceptual basis of the generic scenarios identified for the release of buildings assumes continued commercial use of a building (not residential use). This assumption is considered to be prudently conservative, while continuous exposure would be the worst case.

Two exposure scenarios are defined for buildings: building renovation and normal building occupancy. The building renovation scenario, in Section 3.1, accounts for an average volume (subsurface) concentration of radionuclides in building walls, floors, and ceilings. The building occupancy scenario, in Section 3.2, accounts for radionuclides in a thin surface layer, with a small fraction being removable. Building renovation represents relatively short-term exposures to disturbed sources, while building occupancy represents long-term chronic exposure to low levels of loose contamination. This dual-scenario approach permits the calculation of generic annual TEDEs for volume and surface sources of residual radioactive materials. This approach should help develop screening levels for well-defined situations, permit consideration of site-specific conditions using alternative parameter assignments, and assist in determining when more detailed site-specific data, models, and assessments are required. Additional information regarding specific parameter values used for the analysis is provided in Section 6.

3.1 Building Renovation Scenario

At the time of license termination, it is likely that decontamination operations will have effectively eliminated (or significantly reduced) removable surface sources of residual radioactive contamination. It is also likely that, at some point, buildings will require renovation and, ultimately, they will be demolished. During renovation or demolition, surface and volume sources will be disturbed, creating loose contamination. This loose contamination can produce higher concentrations of radionuclides in the air or on surfaces than the levels in an undisturbed building.

Renovation conditions serve as the prudently conservative basis for this scenario analysis. The differences between renovation and demolition are difficult to predict, but both can likely be represented by the same conceptual model. For some conditions, demolition may represent a worst-case situation; in others, renovation may be the worst case. For example, the exposure duration for demolition may exceed the duration of renovation. Whereas demolition may be rather remote, involving the use of heavy wrecking equipment, renovation may involve work indoors with direct contact with residual radioactive materials.

The work activities associated with building renovation will likely be quite varied, ranging from heavy construction to light finish work. Figure 3.1 shows a variety of expected activities, including removal of a portion of a concrete structure, creating loose surface contamination. Other renovation activities, such as carpentry, plumbing, or painting, will likely be less rigorous, but they are assumed to occur with an elevated amount of loose surface contamination. Figure 3.1 illustrates the modeling basis for the renovation scenario pathways, which account for all four expected activities. The following sections describe the scenario time frame, the potential exposure pathways (describing both those that are included and excluded from the analysis), and the mathematical formulations needed to describe the renovation scenario exposure pathways.

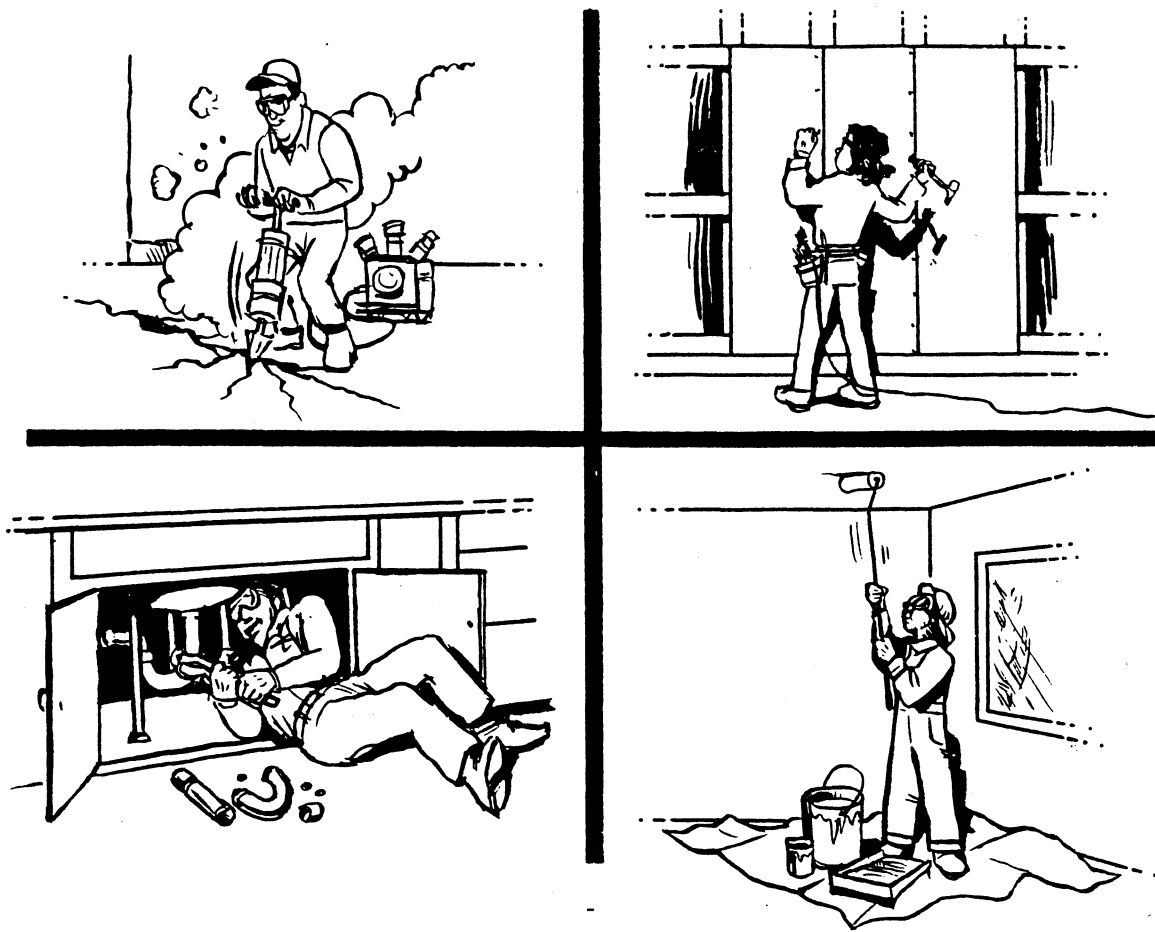

Figure 3.1 Potential activities within the building renovation scenario

3.1.1 Time Frame for Building Renovation Scenario

The time frame for exposure for the building renovation scenario is illustrated in Figure 3.2. Although building renovation may occur at any time after license termination, this study assumes that it occurs immediately after release of the building, before additional radioactive decay takes place. The workers are assumed to be involved in only one renovation operation during the year.

The top portion of Figure 3.2 shows an exact description of exposure to a decaying source during renovation. The dark lines indicate exposure for 8 h/d, 5 d/wk over the total exposure period. The lower part of Figure 3.2 shows the mathematical representation of the exact solution using the exposure duration and the mean activity level. The mean activity level is evaluated using the activity time-integral, $S\{\}$ (discussed in Section 2), divided by the duration of the renovation. This formulation of mean activity level is used in each of the exposure pathway mathematical formulations.

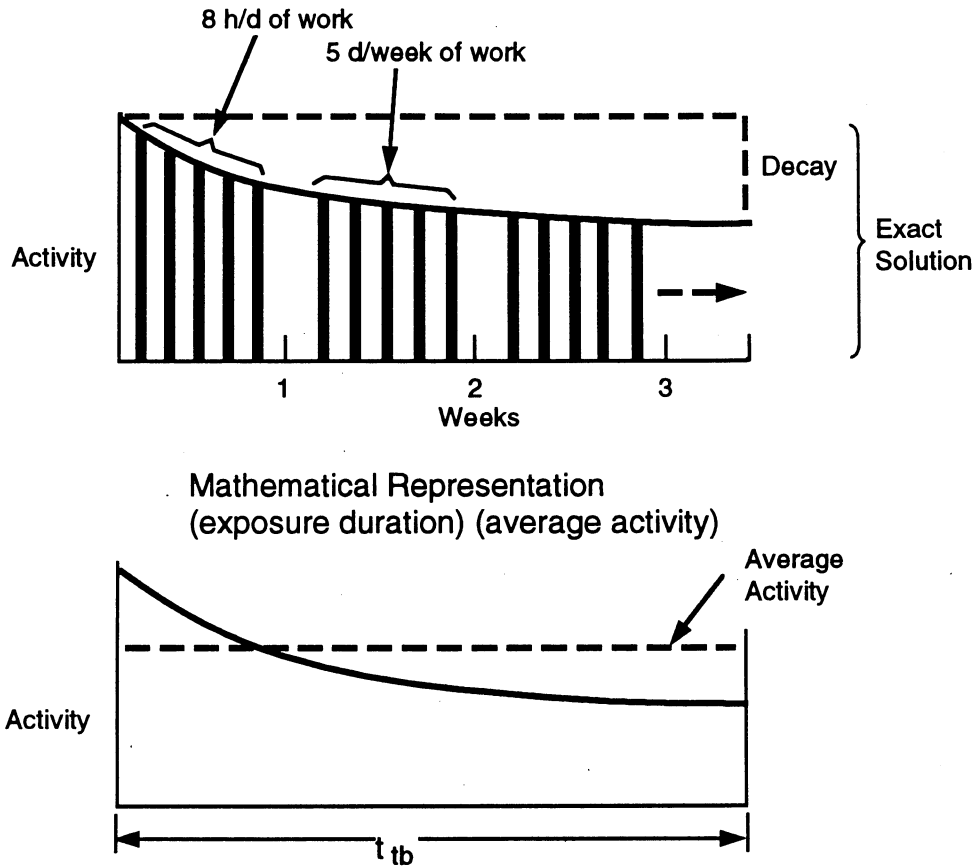

Figure 3.2 Building renovation time frame

3.1.2 Exposure Pathways for Building Renovation Scenario

As can be inferred from Figure 3.1, numerous potential exposure pathways can be identified during building renovation. Although the potential pathways may be quite numerous, some will produce greater radiation dose than others. The potential pathways are shown in the following list, with those selected for analysis shown in bold type.

- **external exposure to penetrating radiation from volume sources**
- **inhalation of airborne radioactive dust**
- **inadvertent ingestion of loose surface contamination**
- external exposure from submersion in airborne radioactive dust
- internal contamination from puncture wounds during building renovations

Building Scenarios

- dermal absorption of radionuclides
- inhalation of the indoor radon aerosol.

The exposure pathways selected for analysis in the building renovation scenario include external exposure to penetrating radiation from volume sources, inhalation of airborne dust, and inadvertent ingestion of dust. The selection of these pathways, along with the selection of prudently conservative parameter values, provides a balanced analysis for each of the following:

- photon-emitters, through the external exposure pathway
- alpha-emitters, through the inhalation exposure pathway
- beta-emitters, through inadvertent ingestion of "loose" surface contamination.

The four potential pathways identified above but not included in this analysis are external exposure during submersion in airborne radioactive dust, internal contamination from puncture wounds, dermal absorption, and inhalation of radon aerosol. Reasons for excluding these four pathways are provided below.

Air submersion can be an important pathway to consider when evaluating the potential consequences of airborne plumes from accidents at nuclear facilities. However, numerous previous studies for decommissioning have concluded that external doses from air submersion are trivial compared with external doses from surface or volume sources (Schneider and Jenkins 1977; Smith, Konzek, and Kennedy 1978; Oak et al. 1980). Thus, air submersion doses are not included in the scenarios considered in this study.

Similarly, internal exposures from puncture wounds or from dermal absorption may be important when evaluating sources of exposure to workers in licensed nuclear facilities. But most dose assessments using these pathways are retrospective (after-the-fact) and rely on bioassay results to help establish the magnitude of internal deposition that occurred for a specific situation. The frequency of occurrence of puncture wounds, although unpredictable, is assumed to be low considering the exposure pathways involved. Dermal absorption may be important for only a few radionuclides, most notably ^3H . To help account for dermal absorption of ^3H , the ICRP increased the inhalation dose factors by 50%. The doses that could result from dermal absorption for other radionuclides are assumed to be low compared with inhalation and ingestion. Thus, internal doses from puncture wounds and dermal absorption are not included in this scenario.

Under some conditions, inhalation of radon aerosol from the uranium decay chain can be a significant pathway. The concentration of indoor radon is a complex function of the quantity of uranium and decay chain members present, the building design, and the air exchange rate with outdoor air. In addition, indoor radon may be present from naturally occurring concentrations of uranium decay chain members, not just residual radioactive contamination from licensed activities. Because of the site-specific nature of the indoor radon aerosol and because the EPA has developed separate regulations for indoor radon, no attempt is made to model exposure from the indoor radon aerosol for this study.

A further justification for excluding these four pathways stems from the intent to produce a set of prudently conservative (not worst-case) generic screening scenarios. Additional pathways can be included, as necessary, in site-specific ALARA evaluations using site-specific data.

3.1.3 External Dose

The external dose is evaluated for renovation work lasting for a specified exposure duration (t_b) in the year, occurring over a specified renovation work period (t_{tb}). The concepts involved in the external dose calculation for the building renovation scenario are described in the following word equation:

$$\begin{aligned}
 [\text{External Dose}] &= [\text{Exposure Duration for Renovation}] \\
 &\times [\text{Volume Source Dose Rate Factor}] \\
 &\times [\text{Average Concentration of Radionuclides} \\
 &\quad \text{in Building Material}]
 \end{aligned}
 \tag{3.1}$$

The external dose calculation involves evaluation of the average concentration of radionuclides in building material over the period of exposure. The amount of a radionuclide present at any time is evaluated as the solution to the following differential equation (quantities expressed in atoms):

$$\frac{d C_{bj}}{dt} = \sum_{n=1}^{j-1} d_{nj} \lambda_{rj} C_{bn} - \lambda_{rj} C_{bj}
 \tag{3.2}$$

where C_{bj} = concentration of radionuclide j present in building material at time t (pCi/g)

C_{bn} = concentration of precursor radionuclide n present in building material at time t (pCi/g)

d_{nj} = fraction of radionuclide n transitions that result in production of radionuclide j .

λ_{rj} = radioactive decay constant for radionuclide j (d^{-1}).

The average concentration of a radionuclide in building material is evaluated as the time integral of the solution to Equation (3.2) as follows:

$$\bar{C}_{bj} = \frac{1}{t_{tb}} \int_0^{t_{tb}} C_{bj} dt
 \tag{3.3}$$

where \bar{C}_{bj} is the average concentration of radionuclide j in building material over the period of renovation work (pCi/g), and t_{tb} is the duration of the renovation period (d).

The mathematical formulation for calculating external dose for the building renovation scenario is given by the following equation:

Building Scenarios

$$\text{DEXB}_i = 24 t_b \sum_{j=1}^{J_i} \left(\text{DFER}_j S\{C_{bj}, t_{tb}\} / t_{tb} \right) \quad (3.4)$$

where DEXB_i = external dose from the specified renovation work duration for the decay chain with parent radionuclide i (mrem for renovation during 1 year)

DFER_j = external dose rate factor for exposure to a volume source of radionuclide j , compatible with the volume source intent of the building renovation scenario, as described in Section 6 (mrem/h per pCi/g)

t_b = exposure duration for renovation period (d)

$S\{C_{bj}, t_{tb}\}$ = time-integral operator used to develop the average concentration of radionuclide j in building material over the renovation period (pCi•d/g for renovation during 1 year)

C_{bj} = initial concentration of radionuclide j in building material (pCi/g)

t_{tb} = duration of the renovation period (d)

J_i = number of radionuclides in the decay chain for parent radionuclide i

24 = unit conversion factor (h/d).

The time integral of concentration in building material is evaluated for each chain member. For the parent radionuclide of a decay chain, the time integral is equivalent to the following expression:

$$S\{C_{b1}, t_{tb}\} = \left\{ C_{b1}(0) \left[1 - e^{-\lambda_{r1} t_{tb}} \right] / \lambda_{r1} \right\} \quad (3.5)$$

where λ_{r1} is the radioactive decay constant for the parent radionuclide (first chain member) (d^{-1}), $C_{b1}(0)$ is the initial concentration of parent radionuclide in building material (pCi/g), and other terms are as previously defined.

When the decay chain contains progeny radionuclides, the decay operator provides an array of results, one value for each chain member. The time-integral value for the parent radionuclide is given by Equation (3.5). The value for the first progeny is given by the following equation:

$$S\{C_{b2}, t_{tb}\} = \left\{ \frac{C_{b1}(0) d_{12} \lambda_{r2}}{(\lambda_{r2} - \lambda_{r1})} \left(1 - e^{-\lambda_{r1} t_{tb}} \right) / \lambda_{r1} \right. \\ \left. + \left[C_{b2}(0) - \frac{d_{12} \lambda_{r2} C_{b1}(0)}{\lambda_{r2} - \lambda_{r1}} \right] \left(1 - e^{-\lambda_{r2} t_{tb}} \right) / \lambda_{r2} \right\} \quad (3.6)$$

where λ_{r2} is the radioactive decay constant for the first progeny radionuclide (second chain member), C_{b2} is the value of C_{bj} for the second chain member, and other terms are as previously defined. See Section 2 and Appendix B for a discussion of the decay operator notation and example generation of equations corresponding to Equations (3.5)

and (3.6) for additional progeny. A detailed discussion of the selection of parameter values for calculating the external dose during building renovation is provided in Section 6.

3.1.4 Inhalation Dose for Renovation

The concepts involved in calculating the committed effective dose equivalent (CEDE) for inhalation for the building renovation scenario are described in the following word equation:

$$\begin{aligned}
 [\text{CEDE for Inhalation}] &= [\text{Exposure Duration for Renovation}] \\
 &\times [\text{Volumetric Breathing Rate}] \\
 &\times [\text{Airborne Dust-Loading Factor}] \\
 &\times [\text{Inhalation Dose Factor}] \\
 &\times [\text{Average Concentration of Radionuclides in BuildingMaterial}]
 \end{aligned}
 \tag{3.7}$$

The mathematical formulation for calculating inhalation dose for the building renovation scenario is given by

$$\text{DHB}_i = 24 t_b V_b \text{CDB} \sum_{j=1}^{J_i} \text{DFH}_j S\{C_{bj}, t_{tb}\} / t_{tb}
 \tag{3.8}$$

where DHB_i = CEDE for inhalation for parent radionuclide i for the specified renovation work period (mrem for renovation work in 1 year)

CDB = dust-loading factor in air for renovation work (g/m^3)

DFH_j = inhalation CEDE factor for radionuclide j (mrem per pCi inhaled)

V_b = volumetric breathing rate for building renovation work (m^3/h)

and other terms are as previously defined. A detailed discussion of the airborne dust model and parameter values selected for calculating the inhalation dose during building renovation is provided in Section 6.

3.1.5 Ingestion Dose for Renovation

The final pathway considered for the building renovation scenario is inadvertent ingestion of dust generated during renovation activities. The concepts involved in calculating the CEDE for the inadvertent ingestion are described in the following word equation:

$$\begin{aligned}
 [\text{CEDE for Ingestion}] &= [\text{Exposure Duration for Renovation}] \\
 &\times [\text{Effective Transfer Rate for Ingestion}] \\
 &\times [\text{Ingestion Dose Factor}] \\
 &\times [\text{Average Concentration of Radionuclides in Loose Dust}]
 \end{aligned} \tag{3.9}$$

The mathematical formulation for calculating ingestion dose for the building renovation scenario is given by

$$\text{DGB}_i = 24 t_b \text{GB} \sum_{j=1}^{J_i} \text{DFG}_j S \{C_{bj}, t_{tb}\} / t_{tb} \tag{3.10}$$

where DGB_i = ingestion CEDE for parent radionuclide i for renovation work (mrem for renovation work in 1 year)

GB = effective transfer rate for ingestion of loose dust transferred from building surfaces, to hands, to mouth (g/h of work)

DFG_j = ingestion CEDE factor for radionuclide j (mrem per pCi ingested)

and other terms are as previously defined. A detailed discussion of the parameter values selected for calculating ingestion dose during building renovation is provided in Section 6.

3.1.6 Annual TEDE for the Building Renovation Scenario

The annual TEDE for the building renovation scenario is evaluated as the sum of the contributions from the three exposure pathways, as shown in the following word equation:

$$\begin{aligned}
 [\text{Annual TEDE for Renovation}] &= [\text{External Dose}] \\
 &+ [\text{CEDE for Inhalation}] \\
 &+ [\text{CEDE for Ingestion}]
 \end{aligned} \tag{3.11}$$

The mathematical formulation for calculating the annual TEDE for the building renovation scenario is

$$\text{TEDEB}_i = \text{DEXB}_i + \text{DHB}_i + \text{DGB}_i \tag{3.12}$$

where TEDEB_i is the TEDE for parent radionuclide i (in mrem for renovation work in 1 year) and other terms are as previously defined.

When mixtures of radionuclides are considered, the total dose for the building renovation scenario is evaluated as the sum of the dose from each decay chain:

$$\text{TEDEB}_m = \sum_{i=1}^M (\text{DEXB}_i + \text{DHB}_i + \text{DGB}_i) \tag{3.13}$$

where $TEDEB_m$ is the TEDE for the mixture of radionuclides (in mrem for renovation work in 1 year), M is the number of parent radionuclides in the mixture, and other terms are as previously defined.

When the initial concentration is expressed in Bq/g and the result is expressed in μSv , the evaluation is performed as above, except that the unit conversion factor is required, as follows:

$$TEDEB_{iSI} = 270.3 TEDEB_i \quad (3.14)$$

where $TEDEB_{iSI}$ is the annual TEDE for parent radionuclide i (in μSv for renovation work in 1 year), and the constant 270.3 is a unit conversion factor, relating $\mu\text{Sv/Bq}$ to mrem/pCi.

3.2 Building Occupancy Scenario

At many facilities, the residual radioactive inventory will be associated with surface sources. Because surface decontamination operations may not remove all of the surface sources, a scenario describing surface contamination must be considered. For this analysis, the building occupancy scenario accounts for potential exposure to both fixed and removable thin-layer or surface-contamination sources. This assumption is a conservative representation of residual radioactive contamination that will bound the dose rates from volume sources, when equal initial activities are assumed. That is, for an equal activity in surface and volume sources, the dose rate from surface sources will exceed the dose rate from volume sources because of self-shielding. A further discussion of the selection of external dose rate factors is provided in Section 6.2.1. This scenario is used to derive the surface contamination annual TEDE.

The conceptual model used for the building occupancy scenario defined for this study is shown in Figure 3.3. Quite simply, an individual is assumed to occupy a commercial facility in a passive manner without deliberately disturbing surface sources of residual contamination. This means that the levels of "loose" contamination are likely to be substantially less than those encountered in the building renovation scenario. The following sections describe the scenario time frame, the potential exposure scenarios (those that are included and excluded from the analysis), and the mathematical formulations needed to describe the exposure pathways in the building occupancy scenario.

3.2.1 Time Frame of Building Occupancy Scenario

The building occupancy scenario involves chronic exposure to an individual for a full work year in a commercial facility. The time frame for exposures is shown in Figure 3.4. Although occupancy of a building may occur at any time after license termination, for this study occupancy is assumed to begin immediately after release of the building, before significant radioactive decay occurs. Except for exposure duration, Figures 3.2 and 3.4 are identical, showing both the exact and mathematical representation of exposure to a radioactive source. For building renovation, the exposure duration will likely be a fraction of a work year, and for building occupancy, it will likely be a full work year. As in the building renovation scenario, the average activity per unit area is evaluated using the time-integral operator, $S\{\}$ (discussed in Section 2 and Appendix B), divided by the duration of the building occupancy period.

3.2.2 Exposure Pathways

As with the building renovation scenario, numerous potential exposure pathways can be identified during building occupancy. The potential pathways are shown in the following list, with those selected for analysis shown in bold type:

- **external exposure to penetrating radiation from surface sources**

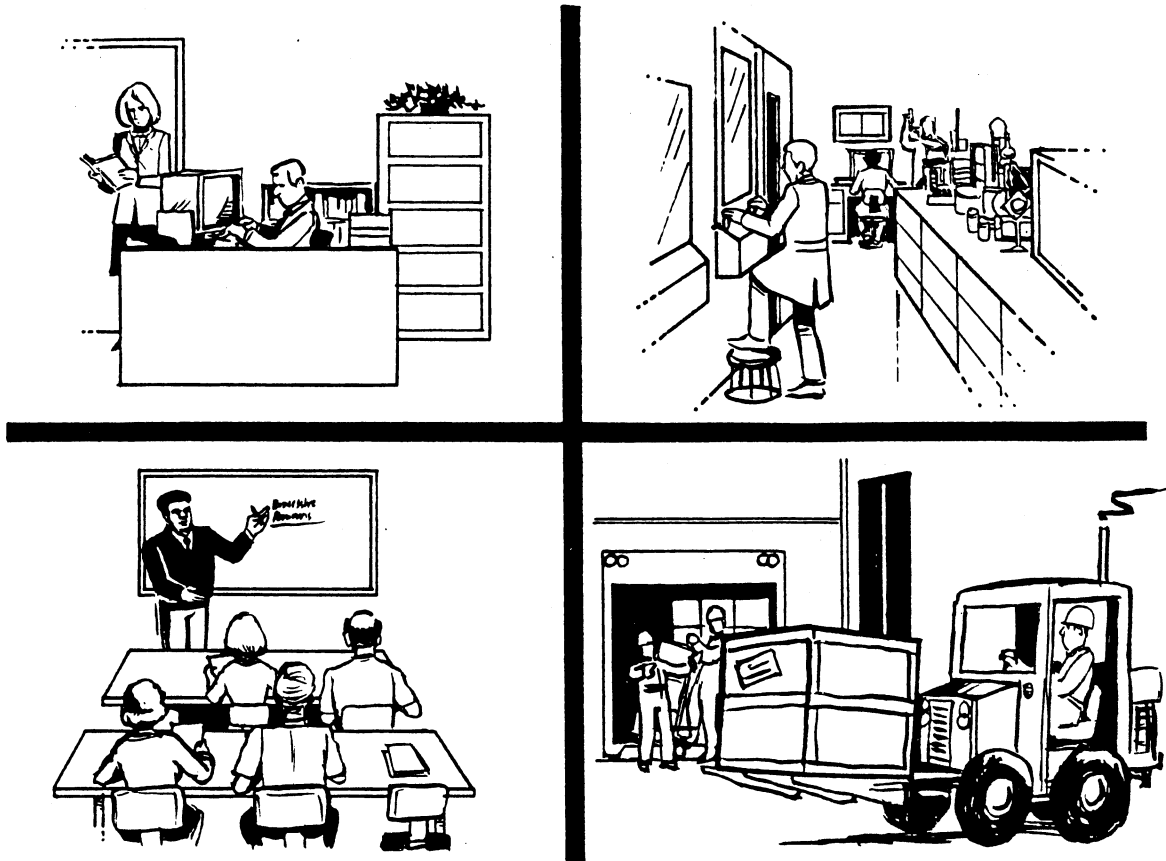

Figure 3.3 Potential activities within the building occupancy scenario

- **inhalation of resuspended surface contamination**
- **inadvertent ingestion of surface contamination**
- external exposure during submersion in airborne radioactive dust
- internal contamination from puncture wounds inflicted by contaminated surfaces
- dermal absorption of radionuclides
- inhalation of indoor radon aerosol.

The exposure pathways selected for analysis in the building occupancy scenario include external exposure to penetrating radiation from surface sources, inhalation of resuspended surface contamination, and inadvertent ingestion of surface contamination. The selection of these pathways, with prudently conservative parameter values, provides a balanced analysis for

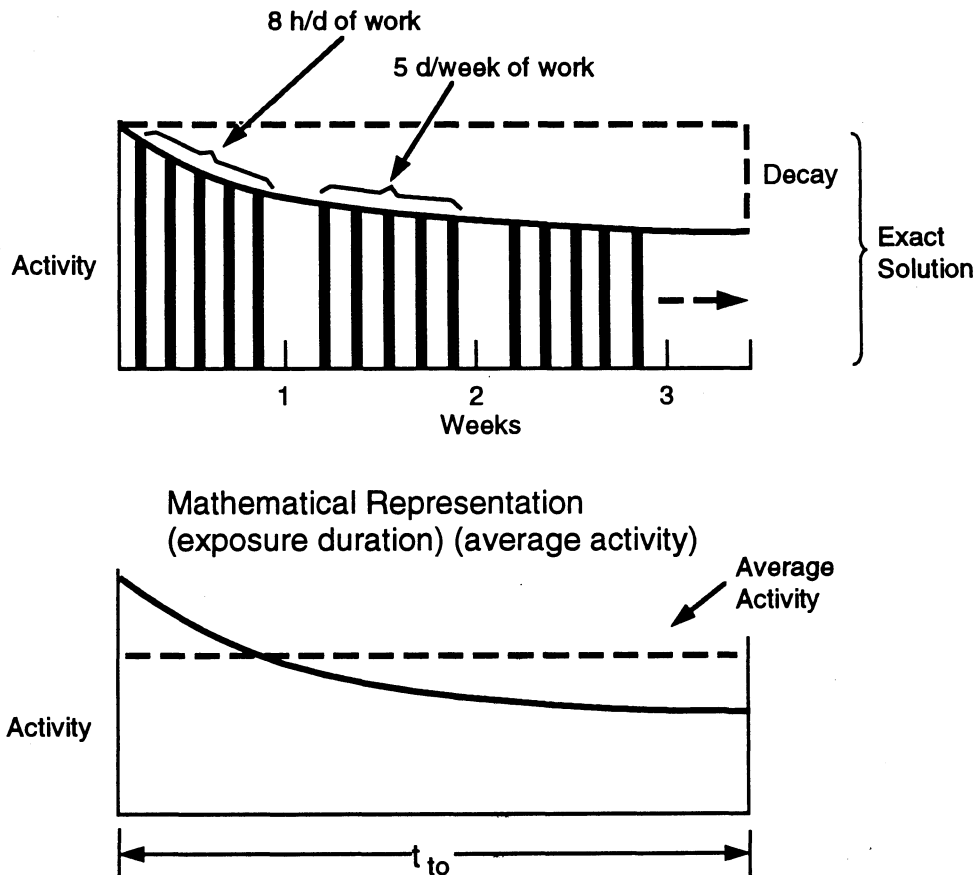

Figure 3.4 Building occupancy time line

- photon-emitters, through the external exposure
- alpha-emitters, through the inhalation exposure pathway
- beta-emitters, through the inadvertent ingestion pathway.

The potential pathways identified above but not included in this analysis are external exposure during submersion in airborne radioactive dust, internal contamination from puncture wounds, dermal absorption, and inhalation of the indoor radon aerosol. The justification for eliminating these pathways is the same as provided in Section 3.1.2 for the building renovation scenario. In addition, airborne contamination levels for air submersion are likely to be quite low during occupancy compared with renovation, further reducing the potential importance of air submersion. Puncture wounds from contaminated surfaces are even less likely for building occupancy because there are no construction-related activities. As with the building renovation scenario, additional pathways can be included, as necessary, in site-specific ALARA evaluations using site-specific data.

3.2.3 External Dose for Building Occupancy

The concepts involved in the external dose calculation for the building occupancy scenario are described in the following word equation:

$$\begin{aligned}
 [\text{External Dose}] &= [\text{Exposure Duration for Occupancy}] \\
 &\times [\text{Surface Source Dose Rate Factor}] \\
 &\times [\text{Average Surface Activity per Unit Area}]
 \end{aligned}
 \tag{3.15}$$

The mathematical formulation for calculating external dose for the building occupancy scenario is given by

$$\text{DEXO}_i = 24 t_o \sum_{j=1}^{J_i} \text{DFES}_j S\{C_{oj}, t_{to}\} / t_{to}
 \tag{3.16}$$

where DEXO_i = external dose for parent radionuclide i (mrem for 1 year of building occupancy)

DFES_j = external dose rate factor for radionuclide j , for exposure from contamination uniformly distributed on surfaces, compatible with the surface-source intent of the building occupancy scenario, as described in Section 6 (mrem/h per dpm/100 cm²)

C_{oj} = initial activity per unit area for radionuclide j on building surfaces (dpm/100 cm²)

$S\{C_{oj}, t_{to}\}$ = time-integral operator used to develop the radionuclide j activity over the exposure period t_{to} (dpm•d/100 cm²)

t_{to} = length of the occupancy period (d)

t_o = time that exposure occurs during the 1-year building occupancy period (d)

24 = unit conversion factor (h/d).

The formulation is similar to the external dose formulation in Equation (3.4), with the exception that for the building occupancy scenario, surface sources instead of volume sources are considered. The time-integral of activity, $S\{C_{oj}, t_{to}\}$, is evaluated for parent radionuclides, as discussed in Section 2 and Appendix B and illustrated in sample equations for parent and first progeny for the building renovation scenario (see Equations [3.5] and [3.6]). A detailed discussion of parameter values for calculating the external dose during building occupancy is provided in Section 6.

3.2.4 Inhalation Dose for Building Occupancy

Inhalation exposure is evaluated for residual material resuspended from building surfaces. The concepts involved in calculating the inhalation CEDE are described in the following word equation:

$$\begin{aligned}
 [\text{CEDE for Inhalation}] &= [\text{Exposure Duration for Occupancy}] \\
 &\times [\text{Resuspension Factor for Surface Contamination}] \\
 &\times [\text{Volumetric Breathing Rate}] \\
 &\times [\text{Inhalation Dose Factor}] \\
 &\times [\text{Average Surface Activity per Unit Area}].
 \end{aligned}
 \tag{3.17}$$

The mathematical formulation for calculating inhalation dose for the building occupancy scenario is given by

$$\text{DHO}_i = 45.05 [24 t_o] \text{RF}_o V_o \left(\sum_{j=1}^{J_i} \text{DFH}_j S \{C_{oj}, t_o\} / t_o \right)
 \tag{3.18}$$

where DHO_i = CEDE for inhalation for parent radionuclide i (mrem for 1 year of building occupancy)

RF_o = resuspension factor for building occupancy (m^{-1})

DFH_j = inhalation CEDE factor for radionuclide j , as described in Section 6 (mrem per pCi inhaled)

45.05 = unit conversion factor (pCi/m^2 per $\text{dpm}/100 \text{ cm}^2$)

24 = unit conversion factor (h/d)

V_o = volumetric breathing rate for building occupancy (m^3/h) p12000 ?

and other terms are as previously defined. A detailed discussion of the resuspension model and the parameter values selected for calculating the inhalation dose during building occupancy is provided in Section 6.

3.2.5 Ingestion Dose for Building Occupancy

The concepts involved in calculating the CEDE for inadvertent ingestion are described in the following word equation:

$$\begin{aligned}
 [\text{CEDE for Ingestion}] &= [\text{Exposure Duration for Occupancy}] \\
 &\times [\text{Effective Transfer Rate for Ingestion}] \\
 &\times [\text{Ingestion Dose Factor}] \\
 &\times [\text{Average Surface Activity per Unit Area}].
 \end{aligned}
 \tag{3.19}$$

Building Scenarios

The mathematical formulation for calculating ingestion dose for the building occupancy scenario is given by

$$DGO_i = 45.05 [24 t_o] GO \sum_{j=1}^{J_i} DFG_j S \{C_{oj}, t_{to}\} / t_{to} \quad (3.20)$$

where DGO_i = CEDE for ingestion for parent radionuclide i (mrem for 1 year of building occupancy)

GO = effective transfer rate for ingestion of removable surface contamination transferred from surfaces, to hands, then to mouth for the building occupancy scenario (m^2/h)

DFG_j = ingestion CEDE for radionuclide j , as described in Section 6 (mrem per pCi ingested)

45.05 = unit conversion factor (pCi/ m^2 per dpm/100 cm^2)

24 = unit conversion factor (h/d)

and other terms are as previously defined.

A discussion of the parameter values selected for calculating ingestion dose during building occupancy is provided in Section 6.

3.2.6 Annual TEDE for the Building Occupancy Scenario

The annual TEDE for the building occupancy scenario is evaluated as the sum of the contributions from the three exposure pathways, as shown in the following word equation:

$$\begin{aligned} [\text{Annual TEDE for Occupancy}] &= [\text{External Dose}] \\ &+ [\text{CEDE for Inhalation}] \\ &+ [\text{CEDE for Ingestion}]. \end{aligned} \quad (3.21)$$

The mathematical formulation for calculating the annual TEDE for the building occupancy scenario is

$$TEDEO_i = DEXO_i + DHO_i + DGO_i \quad (3.22)$$

where $TEDEO_i$ is the annual TEDE for radionuclide i (in mrem for 1 year of building occupancy) and the other terms are as previously defined.

When mixtures of radionuclides are considered, the annual TEDE for the building occupancy scenario is evaluated as the sum of the annual TEDE from each decay chain:

$$TEDEO_m = \sum_{i=1}^M (DEXO_i + DHO_i + DGO_i) \quad (3.23)$$

where $TEDEO_m$ is the annual TEDE for the mixture of radionuclides (in mrem for 1 year of building occupancy) and other terms are as previously defined.

When initial activity per unit area is defined in units of $Bq/100\text{ cm}^2$, the following equation is used to evaluate the annual TEDEO values in μSv :

$$TEDEO_{iSI} = 600 TEDEO_i \quad (3.24)$$

where $TEDEO_{iSI}$ is the annual TEDE for the parent radionuclide i (in μSv for a year of building occupancy), and the constant 600 is a unit conversion factor ($\mu Sv/Bq$ per mrem/dpm).

4 Drinking Water Scenario

The drinking water scenario (presented schematically in Figure 4.1) models the dose to persons whose sole exposure is from drinking ground water that contains radionuclides leached from surface soil, as determined by a generic water-use model. This scenario is included to permit a comparison with the drinking water standards of the EPA. The individual exposed via drinking water is assumed to obtain all of his or her drinking water from the contaminated aquifer over a period of 1 year, with a constant ingestion rate. The concentration of radionuclides in the ground water is taken as an annual average value based on the total activity of a radionuclide, or mixture of radionuclides, that is in the ground water during the year of exposure. The time frame for the drinking water scenario is shown in Figure 4.2. The concentration of a radionuclide or mixture of radionuclides in ground water will conceptually be a function of the physical and chemical properties of the radionuclides, soil, and ground-water system. Figure 4.3 is a simple representation of how the concentration of two radionuclides (shown as "a" and "b") in ground water may vary with time. It is important, therefore, to account for time-dependent behavior in the generic water-use model.

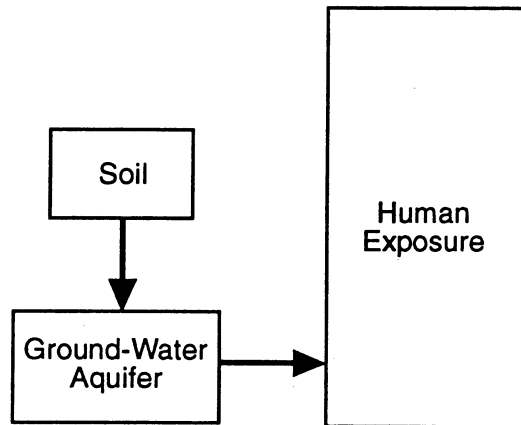

Figure 4.1 Drinking water dose pathway

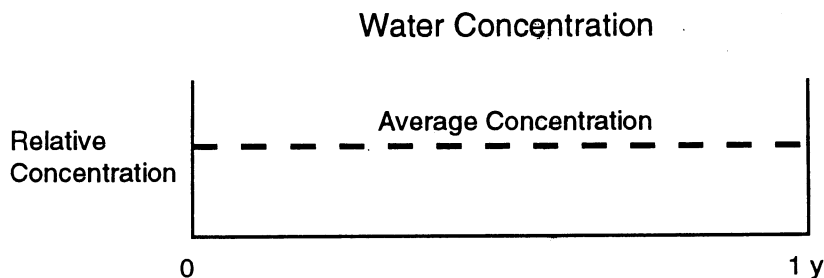

Figure 4.2 Time frame for drinking water scenario

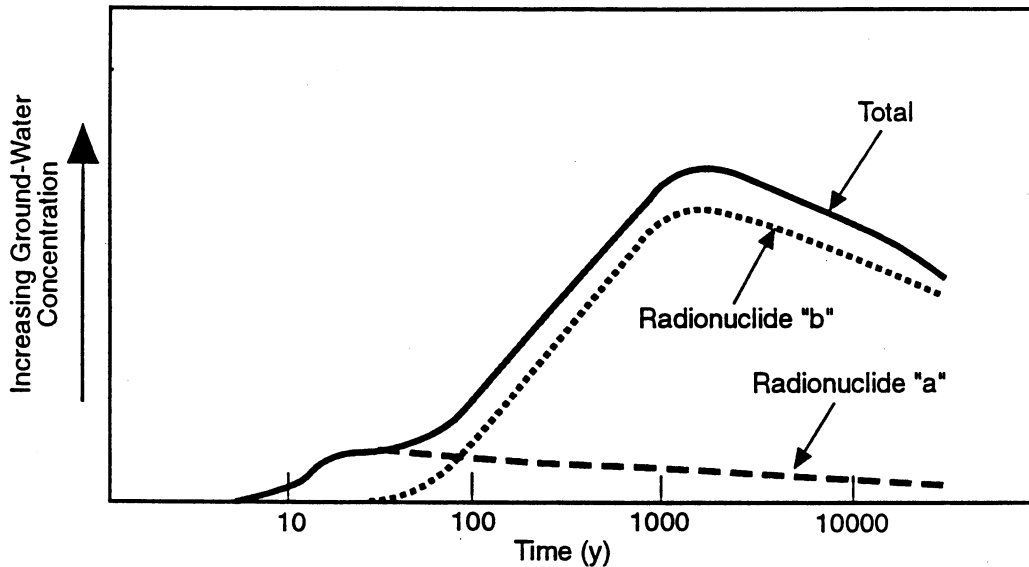

Figure 4.3 Example of time dependence of ground-water concentration

This section discusses the three-box water-use model used to estimate time-dependent ground-water concentrations and the methods used to calculate annual TEDE for the drinking water scenario.

4.1 Water-Use Model

This section describes the method used to evaluate the ground-water concentration as a function of time in order to determine the maximum dose (and year of maximum dose) for the drinking water scenario. The initial activity in surface soils or in buildings that may be left as buried rubble onsite is defined at the time the land is released for public use.

4.1.1 Characteristics of Water-Use Model Suitable for Screening

Residual radioactive contamination in soil has the potential to contaminate ground water in either the saturated or unsaturated zones. The primary mechanisms controlling potential ground-water contamination include infiltration and leaching, transport through the unsaturated zone, and transport through the saturated zone. Many additional characteristics of the site influence these mechanisms, including precipitation rates, the land's surface properties, soil properties, the chemical nature of the radioactive contamination, spatial distributions of the contamination, and advection/retardation in the aquifer. More complete discussions of ground water can be found in Freeze and Cherry (1979), Isherwood (1981), and Wilson and Miller (1979). Previous efforts by the NRC have established a family of models that have fairly broad application to matters related to waste management. These models include those by Goode et al. (1986); Konikow and Bredehoeft (1978); Tracy (1982); Codell, Key, and Whelan (1982); and Codell (1984).

The wide variability of physical and chemical conditions that potentially influence ground water, and the dependence on many parameters that may have a coupled dependency, make it difficult to model ground-water systems. In

addition, a conceptual model of a ground-water system is only an approximation of reality and may not represent all of the behavior of that system. The cost of site characterization, model selection, and model validation may be prohibitive if a trivial source of contamination exists. Because of the system's potential variability, its modeling uncertainty, and the costs of collecting and modeling the data, generic modeling generally encourages the use of worst-case (overly conservative) predictions of the ground-water system's responses. The existence of site data may allow the use of more realistic and sophisticated models, but the data may be point values (in both location and time) and may still not appropriately represent the actual system being modeled.

A middle ground between costly site-characterization and overly conservative generic modeling may be the use of simple, generic screening models for estimating drinking water concentrations with the use of data and assumptions that should be readily available for any site. The purpose of the generic screening modeling conducted for this document is to derive concentration values in an aquifer from residual radioactive materials in soil in a conservative manner that will indicate when additional site-specific data or modeling sophistication are warranted. It is recognized that the results may be prohibitive for all but trivial cases. However, it is also recognized that the types of data and assumptions used in the generic screening approach should be easily obtained for any given site so that some site-specific modifications may be possible.

The modeling approach developed for the onsite disposal of radioactive wastes (Goode et al. 1986) is potentially applicable to residual radioactive soil contamination. Goode et al. (1986) provide a discussion of a methodology for estimating the potential contamination of ground water by materials disposed in soils by licensees. Their methodology includes the formulation of a conceptual model, representation of the conceptual model mathematically, estimation of conservative parameters, and prediction of receptor concentrations. Conservative models, assumptions, and parameter selections (i.e., those that are likely to overestimate the receptor concentration) are used for their methodology because of the need to ensure that underestimates of the potential consequences do not occur. When valid site data exist, they recommend that more realistic parameters and models should be used to refine the predictions. In an appendix, Goode et al. (1986) provide an overview of the types of mathematical models that should be considered when developing a detailed evaluation of potential waste disposal impacts on ground-water resources.

4.1.2 Three-Box Water-Use Model

For the soil scenarios, a conservative method of estimating the concentration of radionuclides in a ground-water aquifer is to use a simple leach-rate model accounting for total water use. Leach rates are dependent on the chemical properties of the radionuclides and soil and the rate of local water movement. For this water-use model, it was assumed that radionuclides would be transferred to the ground water because of contact with infiltrating water (i.e., as a function of the solubility of material in water with no retardation in soils). To account for potential *saturated* and *unsaturated* conditions, a three-box compartmental model is used for this study to estimate the transfer of activity from the surface to the ground-water aquifer over time.

A conceptual representation of the three-box water-use model for the drinking water scenario is shown in Figure 4.4. This figure shows the three boxes and indicates the flow of water through the system with infiltration being the driving force for transfer from the surface soil to the ground-water aquifer. The following assumptions are implied by the model:

- Initial radioactivity is contained within the top layer (box 1).
- The unsaturated-soil layer (box 2) and the aquifer (box 3) are initially free of contamination.
- The vertical saturated hydraulic conductivity is greater than the infiltration rate.

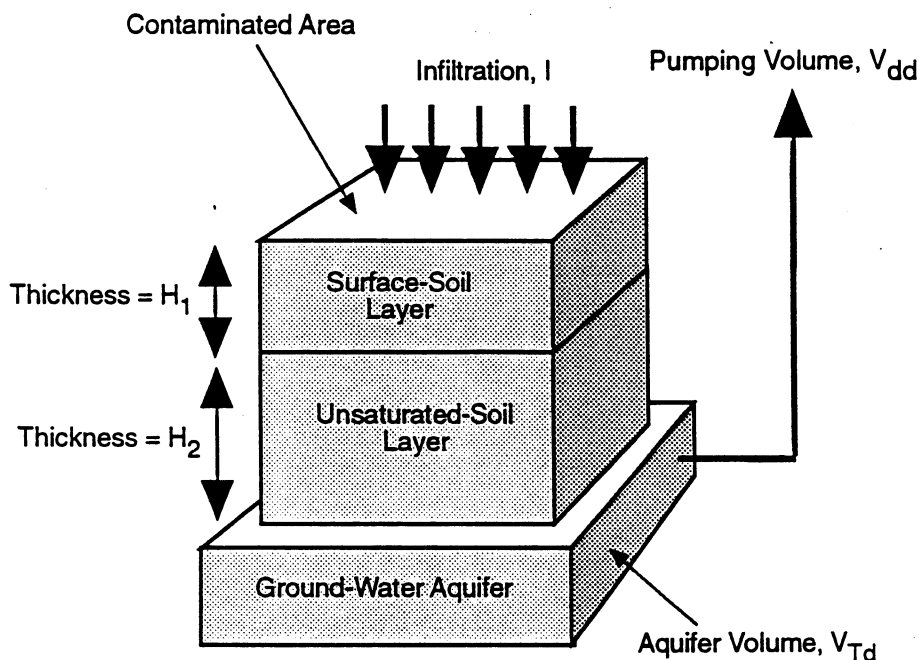

Figure 4.4 Conceptual representation of the drinking water scenario water-use model

- There is no retardation in the aquifer.
- The activity in the aquifer is diluted by the volume of water in the aquifer.
- The volume of water in the aquifer volume is considered to be the greater of the following: 1) the volume of infiltrating water or 2) the volume of water used for domestic purposes.
- The infiltration volume is the product of the infiltration rate and the area of land contaminated.
- Water is removed from the aquifer at a constant rate during all years of interest in the analysis.

The initial activity is assumed to be contained within the first soil layer as a reasonable approach for a generic water-use model. While some sites may exist that have contamination spread through all layers and even into the aquifer, these cases should be evaluated on a site-specific basis, rather than by using this generic model.

The annual volume of water in the aquifer is defined as the greater of two volumes: 1) the volume of water pumped annually for domestic uses or 2) the volume of water infiltrating through the surface-soil layer during one year. This definition is used to avoid the unrealistic case that can result when the area of contaminated land is large. For cases involving large areas of contamination, the annual volume of infiltrating water can exceed the annual volume of water required to meet domestic water demands. Without the above definition of aquifer water volume, the concentration in

the aquifer would unrealistically increase over the concentration in the unsaturated-soil layer because the volume of water delivering the contaminant to the aquifer (i.e., the volume of infiltrating water) would be greater than the volume of the water in the aquifer.

The assumption regarding the vertical saturated hydraulic conductivity means that the soil conditions will allow water to move vertically downward at least as fast as the infiltration rate (expressed as distance per year).

Figure 4.5 represents the movement of material in the simple three-box leach model. Box 1 in the figure represents the initial inventory in a surface layer, with removal of material by either radioactive decay (λ parameters) or leaching (L parameters) into box 2, an unsaturated zone. The initial quantity of material in box 1, $C_{1i}(0)$ is defined for each radionuclide of interest in total activity, pCi. The initial quantity of material in boxes 2, $C_{2i}(0)$, and 3, $C_{3i}(0)$, are both zero. The material in box 2 is transferred to the aquifer (box 3). The material in box 3 is removed by pumping to provide domestic water for an individual. The material in box 3 is used to determine the annual average concentration in the ground-water system. The ground-water concentration is evaluated for the year in which the dose via a scenario reaches a maximum, with consideration of the ingrowth of decay progeny.

The human exposure pathway from the three-box water-use model for the drinking water scenario is illustrated in Figure 4.1. Exposure via ingestion of drinking water originates directly from box 3 of the three-box water-use model (the ground-water aquifer). The concentration of radionuclides in the aquifer (box 3) is evaluated as the quotient of the activity in box 3 (the aquifer) and the annual volume of water in the aquifer.

4.1.3 Equations for Radionuclide Transfer in Soil Using the Water-Use Model

Figure 4.5 includes a simple representation of a three-member radionuclide decay chain. In this representation, each radionuclide has its own radioactive decay constant and transfer rate constant between boxes. Evaluation of the year in which the maximum annual TEDE occurs requires that annual TEDEs be calculated over a number of years until all radionuclides have reached a maximum annual activity in the third box. The following discussion gives the mathematical description of the three-box water-use model for the drinking water scenario where no irrigation recycling occurs; the irrigation recycling is included in the water-use model for the residential scenario, as described in Section 5.6.6.

The equations consider decay chain members produced in each of the boxes from precursor radionuclides. The amounts of each chain member (parameter C) are represented as the total activity present. This representation is made for consistency with the operation of the chain decay equations described below and in Appendix B. The concepts involved in accounting for the quantity of radionuclide j in box 1 at time t are described in the word equation below:

$$\begin{aligned}
 [\text{Rate of Change of } j \text{ in Box 1 at Time } t] &= [\text{Production of } j \text{ from Decay of Precursor } n \text{ at Time } t] \\
 &\quad - [\text{Removal of } j \text{ from Box 1 by Decay at Time } t] \\
 &\quad - [\text{Removal of } j \text{ from Box 1 by Leaching at Time } t].
 \end{aligned}
 \tag{4.1}$$

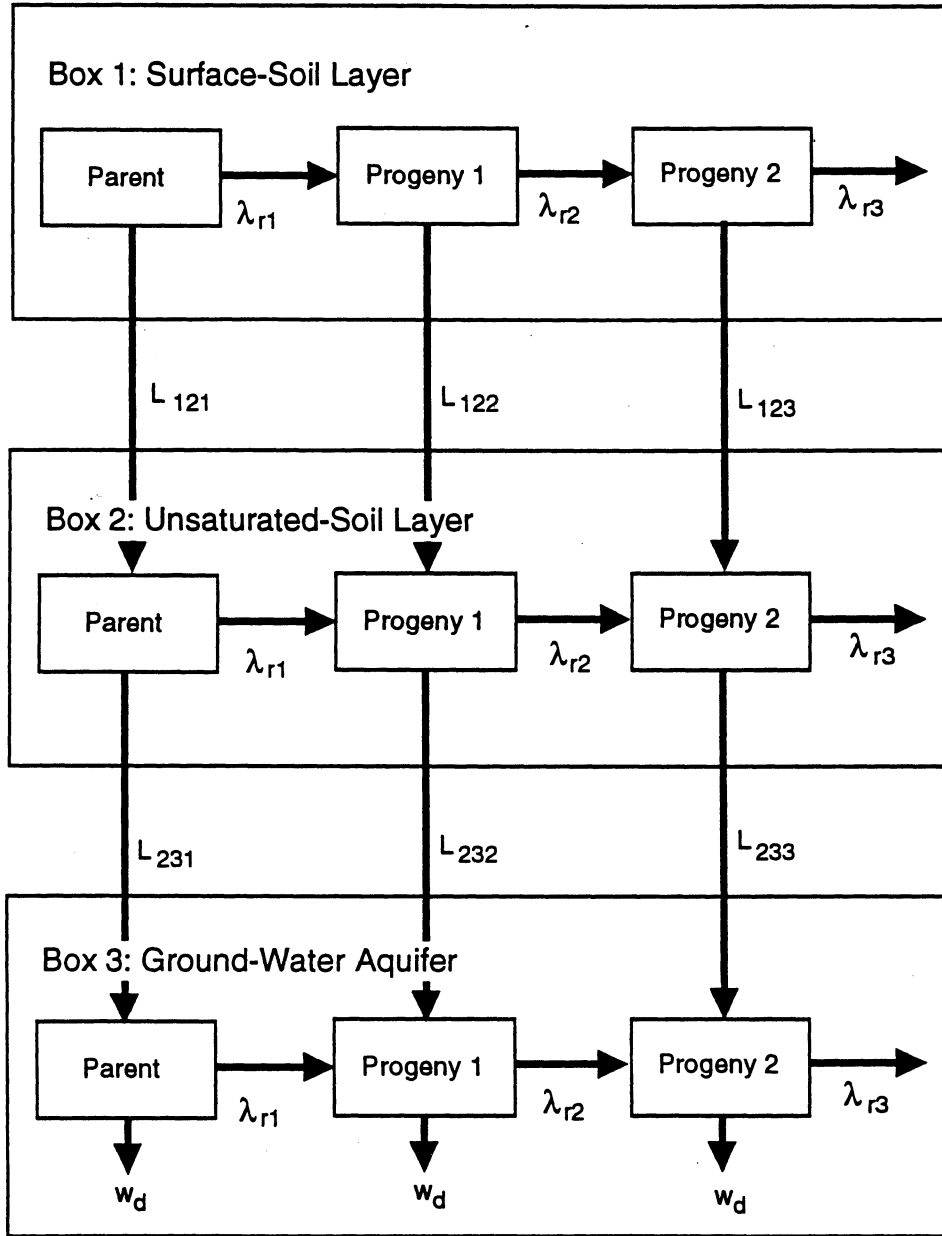

Figure 4.5 Three-box water-use model for the drinking water scenario

The basic differential equation for box 1 has the following form, accounting for original quantities and for radioactive decay (λ terms), and the rate of leaching (L term):

$$\frac{dC_{1j}}{dt} = \lambda_{rj} \sum_{n=1}^{j-1} d_{nj} C_{1n} - (\lambda_{rj} + L_{12j}) C_{1j} \quad (4.2)$$

where C_{1j} = activity of radionuclide j in box 1 at time t (pCi)

C_{1n} = activity of precursor radionuclide n in box 1 at time t (pCi)

j = index of current chain member position in decay chain

n = index of precursor chain members in decay chain ($n < j$)

L_{12j} = rate constant for movement of radionuclide j from box 1 to box 2 (d^{-1})

d_{nj} = fraction of radionuclide n transitions that result in production of radionuclide j (dimensionless)

λ_{rj} = decay rate constant for decay of radionuclide j (d^{-1}).

For box 2, the concepts involved in accounting for the quantity of radionuclide j at time t are described in the word equation shown below:

$$\begin{aligned} [\text{Rate of Change of } j \text{ in Box 2 at Time } t] &= [\text{Production of } j \text{ from Decay of Precursor } n \text{ at Time } t] \\ &+ [\text{Transfer of } j \text{ by Leaching from Box 1 at Time } t] \\ &- [\text{Removal of } j \text{ from Box 2 by Decay at Time } t] \\ &- [\text{Removal of } j \text{ from Box 2 by Leaching at Time } t]. \end{aligned} \quad (4.3)$$

For box 2, the basic differential equation accounts for not only original quantities, radioactive decay, and leaching, but also for quantities entering from box 1:

$$\frac{dC_{2j}}{dt} = \lambda_{rj} \sum_{n=1}^{j-1} d_{nj} C_{2n} + L_{12j} C_{1j} - (\lambda_{rj} + L_{23j}) C_{2j} \quad (4.4)$$

where C_{2j} = activity of radionuclide j in box 2 at time t (pCi)

C_{2n} = activity of precursor radionuclide n in box 2 at time t (pCi)

L_{23j} = rate constant for movement of radionuclide j from box 2 to box 3 (d^{-1})

and other terms are as defined above.

For box 3, the concepts involved in accounting for the quantity of radionuclide j at time t are described in the word equation shown below:

Drinking Water

$$\begin{aligned}
 [\text{Change in } j \text{ in Box 3 at Time } t] = & [\text{Production of } j \text{ from Decay of Precursor } n \text{ at Time } t] \\
 & + [\text{Transfer of } j \text{ by Leaching from Box 2 at Time } t] \\
 & - [\text{Removal of } j \text{ from Box 3 by Decay at Time } t] \\
 & - [\text{Removal of } j \text{ from Box 3 by Pumping at Time } t].
 \end{aligned} \tag{4.5}$$

The differential equation for box 3 is similar to box 2:

$$\frac{dC_{3j}(t)}{dt} = \lambda_{rj} \sum_{n=1}^{j-1} d_{nj} C_{3n}(t) + L_{23j} C_{2j}(t) - \lambda_{rj} C_{3j}(t) - w_d C_{3j}(t) \tag{4.6}$$

where $C_{3j}(t)$ = activity of radionuclide j in box 3 at time t (pCi)

$C_{3n}(t)$ = activity of precursor radionuclide n in box 3 at time t (pCi)

w_d = rate constant for pumping of water from the aquifer for the drinking water scenario (d^{-1})

and other terms are as defined above. The summation term in each of the above equations is evaluated for only those terms for which a transition occurs.

The rate constants for movement between compartments are evaluated as follows. The leach rate from the surface layer is

$$L_{12j} = \frac{I}{H_1 \theta_1 R_{t1j} 365.25} \tag{4.7}$$

where I = the infiltration rate (m/y)

H_1 = the assumed thickness of the surface-soil layer containing the residual radioactive material (m)

θ_1 = volumetric water content of the surface-soil layer (dimensionless)

R_{t1j} = retardation factor for movement of radionuclide j from the surface-soil layer to the unsaturated-soil layer (dimensionless)

365.25 = unit conversion factor (d/y). (Note: a year is represented in this study as 365.25 d to include a correction for leap year so that exact hand calculations may be performed.)

The volumetric water content for the surface-soil layer can be expressed in terms of the total porosity and saturation ratio as follows:

$$\theta_1 = n_1 f_1 \quad (4.8)$$

where n_1 is the total porosity of the surface-soil layer (dimensionless) and f_1 is the saturation ratio for the surface-soil layer (dimensionless).

The retardation factor is calculated from the partition coefficient for the radionuclide in the surface-soil layer, the bulk density of the surface-soil layer, and the total porosity as follows:

$$Rt_{1j} = 1 + \frac{Kd_{1j} \rho_1}{n_1} \quad (1) \quad \frac{cm^3}{ml} \quad (4.9)$$

where Kd_{1j} is the partition coefficient for radionuclide j in the surface-soil layer (mL/g) and ρ_1 is the bulk density of surface-soil layer (g/mL). Evaluation of the retardation factor is based on the total porosity, n_1 , rather than the volumetric water content, θ_1 , for conservatism because the total porosity, and thus all sorption sites, comes into play as the pulses of moisture move through the surface and the unsaturated layers.

The leach rate from the second layer is defined as follows:

$$L_{23j} = \frac{I}{H_2 \theta_2 Rt_{2j} 365.25} \quad (4.10)$$

where θ_2 = volumetric water content of the unsaturated-soil layer (dimensionless)

Rt_{2j} = retardation factor for movement of radionuclide j from the unsaturated-soil layer to the aquifer (dimensionless)

H_2 = the assumed thickness of the second layer (m)

and the other parameters are as previously defined.

The volumetric water content for the unsaturated-soil layer can be expressed in terms of the total porosity and saturation ratio as follows:

$$\theta_2 = n_2 f_2 \quad (4.11)$$

where n_2 is the total porosity of the unsaturated-soil layer (dimensionless) and f_2 is the saturation ratio for the unsaturated-soil layer (dimensionless).

The retardation factor is calculated from the partition coefficient for the radionuclide in the unsaturated-soil layer, the bulk density of the unsaturated-soil layer, and the volumetric water content, as follows:

$$Rt_{2j} = 1 + \frac{Kd_{2j} \rho_2}{n_2} \quad (1) \quad \frac{cm^3}{ml} \quad (4.12)$$

Drinking Water

where Kd_{2j} is the partition coefficient for radionuclide j in the unsaturated-soil layer (mL/g) and ρ_2 is the bulk density of unsaturated-soil layer ($\frac{g}{m^3}$).

The annual average water concentration taken from the ground-water aquifer is evaluated assuming that all of the radionuclide activity that reaches the aquifer is diluted in the total volume of water in the aquifer. This calculation is represented by the time integral of activity in box 3 divided by the dilution volume and the time period. For the first year after release of the site, the average water concentration of a radionuclide in a decay chain is given as follows:

$$C_{swjt} = \frac{1}{V_{Td} t_y} \int_0^{t_y} C_{3j}(t) dt = S_{d3} \{ C_{kj} t_y \} / \left[\frac{C_{ti}(0)}{V_{Td} t_y} \right] \quad (4.13)$$

where C_{swjt} = average annual water concentration factor for radionuclide j for the year of exposure, t , per unit activity of parent radionuclide i in soil at time zero (pCi/L per pCi in soil)

$S_{d3} \{ C_{kj} t_y \}$ = time-integral operator notation for the drinking water scenario used to develop the time integral of activity of radionuclide j in the aquifer (box 3) over a time period t_y of 365.25 d per unit activity of parent radionuclide i in soil at time zero (pCi · d per pCi in soil)

C_{kj} = array of activities of each radionuclide j in each box k at the start of the current year t per unit activity of parent radionuclide i in soil at time zero (pCi per pCi in soil)

$C_{3j}(t)$ = array of activities of each radionuclide j in the aquifer (box 3) as a function of time over the period of integration (pCi per pCi in soil)

k = index on boxes in the three-box water-use model

t_y = averaging time period over 1 year (d)

V_{Td} = total volume of water in the aquifer, constant during a 1-year period (L).

The total water volume in the aquifer or dilution volume, V_{Td} , is taken to be the greater of the volume pumped for domestic uses during a year or the annual volume of infiltrating water. The annual volume of infiltrating water is related to the infiltration rate and the contaminated area as follows:

$$V_{Id} = I A_d 1000 \cdot 1 \quad (4.14)$$

where V_{Id} = annual infiltration volume through the contaminated area (L)

A_d = area of contaminated land defined for the drinking water scenario (m^2)

1000 = unit conversion factor (L/m^3)

1 = time period for infiltration (y)

and other terms are as previously defined. The dilution volume (V_{Td}) must be no less than the infiltration volume. Use of a smaller volume would represent concentration of radionuclides between the surface layer and the aquifer, which is unrealistic.

The pumping rate constant, w_d , is evaluated as a fractional removal rate with the total volume removed during a year being set to the volume of water pumped for domestic uses, V_{dd} (L). The pumping rate constant can be expressed as follows:

$$w_d = \left[\frac{\text{Fractional Removal}}{y} \right] \left[\frac{y}{365.25 \text{ d}} \right] \quad (4.15)$$

where 365.25 is the units conversion factor (d/y). The fractional removal is the fraction of the total water volume, V_{Td} , removed per year. The fractional removal can be expressed as follows:

$$\text{Fractional Removal} = \frac{V_{dd}}{V_{Td}} \quad (4.16)$$

- where V_{dd} = volume of water used for domestic purposes during a year (y) and other terms are as previously defined. Note that when the total volume is equal to the pumping volume (i.e., the infiltration volume is less than the pumping volume), then the fractional removal is 1.

The evaluation of average radionuclide concentration in ground water for time periods beyond the first year is made by application of the decay equations as described in Appendix B. Explicit equations for the decay operator notation, $S_{d3}\{\}$, are presented in Section B.6.

4.2 Calculation of Annual TEDE

Calculation of the annual TEDE involves multiplying the ingestion rate by the ingestion dose rate factor, and then multiplying that product by the average concentration of radionuclides in ground water for 1 year:

$$\begin{aligned} [\text{TEDE for Drinking Water}] &= [\text{Water Ingestion Rate}] \\ &\times [\text{Ingestion Period}] \\ &\times [\text{Ingestion Dose Factor}] \\ &\times [\text{Average Concentration of Radionuclides in Water for 1 Year}]. \end{aligned} \quad (4.17)$$

Drinking Water

In mathematical notation, this equation is

$$\text{TEDED}_i = U_w t_d C_{ti} \sum_{j=1}^{J_i} C_{swjt} \text{DFG}_j \quad (4.18)$$

where TEDED_i = TEDE for radionuclide i for the drinking water scenario (mrem for a year of drinking water scenario with inventory in pCi in soil)

C_{ti} = total activity of parent radionuclide i in soil at time zero (pCi)

C_{swjt} = average annual water concentration factor for radionuclide j for the year of exposure, t , per unit activity of parent radionuclide i in soil at time zero (pCi/L per pCi in soil)

DFG_j = CEDE for ingestion of radionuclide j (mrem per pCi ingested)

U_w = amount of contaminated drinking water ingested during the drinking water exposure period (L/d)

t_d = period over which drinking water is consumed (days for a year of drinking water scenario).

The average concentration of a radionuclide in water for the year of interest is represented in Equation (4.18) as the product of C_{ti} and C_{swjt} . The average annual water concentration factor (C_{swjt}) is evaluated as described below in this section and in Appendix B.

For periods longer than 1 year, the annual average concentration of radionuclides in the ground water is evaluated using the three-box model for each year of the analysis until the maximum value of TEDED_i is found. For radionuclide decay chains, the analysis is continued until all members of the chain have reached a peak concentration and have begun to decrease.

For mixtures of radionuclides, the annual TEDE is evaluated for the year in which the sum of doses from all radionuclides in the inventory is a maximum. This calculation is as follows:

$$\text{TEDED}_m = \sum_{i=1}^M \text{TEDED}_i \quad (4.19)$$

The year in which the maximum dose is obtained will vary by parent radionuclide. For a mixture of radionuclides, the year of the maximum dose may be different than the year of maximum dose for individual radionuclides. It is, therefore, necessary to evaluate Equation (4.19) for the mixture for each year rather than simply using the TEDED_i values for the maximum years of individual decay chains.

When the activity is in units of Bq, the following equation is used to evaluate the TEDED value in μSv :

$$\text{TEDED}_{iSI} = 270.3 \text{ TEDED}_i \quad (4.20)$$

where TEDED_{iSI} is the annual TEDE for radionuclide i (μSv for a year of drinking water scenario with initial inventory in units of Bq in soil) and 270.3 is a unit conversion factor (to convert from mrem/pCi to $\mu\text{Sv}/\text{Bq}$).

In addition to evaluation of the annual TEDE from drinking water, the highest committed dose equivalent to any organ is determined. The highest organ committed dose equivalent (HOCDE) is evaluated for the year in which the annual TEDE is a maximum value. The calculation of the highest organ committed dose equivalent is performed by repeated application of the following equation for each organ (based on Equation [4.18]) and selection of the highest value that results:

$$\text{HOCDE}_i = U_w t_d C_{ti} \sum_{j=1}^{J_i} C_{swjt} \text{DFO}_{jo} \quad (4.21)$$

where HOCDE_i = highest organ committed dose equivalent for radionuclide i from ingestion of drinking water (mrem per year of drinking water scenario for inventory in pCi)

DFO_{jo} = committed dose equivalent to organ o from radionuclide j from ingestion (mrem per pCi ingested)

and other terms are as previously defined. Equation (4.21) is evaluated for all organs (subscript o) and the highest value for HOCDE_i represents the result of the analysis.

The highest organ dose for a mixture is calculated by summing the contributions from all parent radionuclides and chain members contributing to each organ dose. The highest dose is not evaluated from the previously calculated HOCDE_i values because each radionuclide will likely have a different organ associated with its highest organ committed dose equivalent. It is necessary, therefore, to sum all dose contributions across radionuclides in the mixture before the organ receiving the highest dose can be determined. The highest effective organ dose for a mixture of radionuclides is evaluated by repeated application of the following equation and selection of the highest dose result:

$$\text{HOCDE}_m = U_w t_d C_{ti} \sum_{i=1}^M \sum_{j=1}^{J_i} C_{swjt} \text{DFO}_{jo} \quad (4.22)$$

where HOCDE_m is the highest organ committed dose equivalent for a mixture of radionuclides (mrem per year of drinking water scenario for inventory in pCi) and other terms are as previously defined.

Conversion of HOCDE values to units of $\mu\text{Sv/y}$ of drinking water scenario for initial activity in Bq in soil is performed using Equation (4.20) with HOCDE values in place of the corresponding TEDED value.

Criteria and algorithms for finding the year of maximum dose will be established during the software development and reported in Volume 2.

5 Residential Scenario

As with residual radioactive materials in buildings, contaminated soil from licensed operations can exist in a wide diversity of conditions. For example, radionuclides in soil can originate from intentional disposal, accidental spills, or long-term accumulation of material deposited from airborne releases during plant operation. The complexity of the environmental setting also influences the potential pathways and components that may need to be considered in modeling human exposures. Therefore, the conceptual model for residual soil contamination must be broad enough to account for many different, and potentially complex, pathways and conditions. Figure 5.1 shows a variety of potential exposure situations that can result from soil contamination. These potential situations range from simply inhaling air that contains resuspended contaminated soil to ingesting drinking water from a contaminated well or fish from contaminated surface water, or a variety of plant and animal products that may be grown in the contaminated soil. For this generic screening analysis, the radiation doses resulting from contaminated soil are described by the residential scenario. The following sections introduce the concepts used in the residential scenario, the approach for evaluating doses from complex agricultural pathways, the mathematical formulations needed to model concentrations and radionuclide transfer in the agricultural pathways, and the calculation of the annual TEDE for the residential scenario.

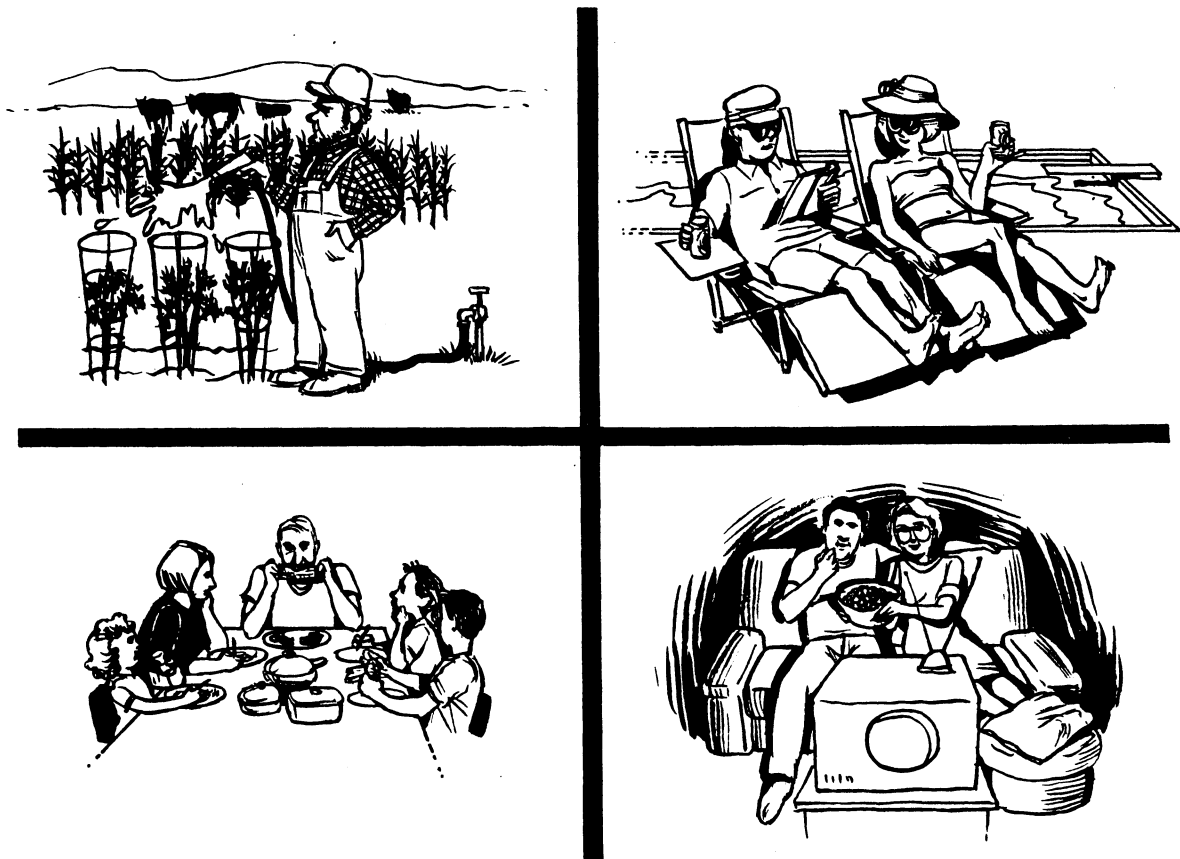

Figure 5.1 Potential activities within the residential scenario

5.1 Residential Scenario: Concepts and Assumptions

The residential scenario defines the potential pathways that can be used to estimate human radiation exposures resulting from residual radioactive contamination in soil. For this scenario, the residual radioactive materials are assumed to be contained in a surface-soil layer on property that can be used for residential and light farming activities. The following sections describe the scenario time frame, the potential exposure pathways (describing both those that are included and those excluded from the analysis), and the radionuclide inventory and transfer associated with agricultural pathways.

5.1.1 Time Frame for the Residential Scenario

The time frame for the residential scenario must potentially account for continuous exposure to multiple exposure pathways during a year; however, the time frame for each pathway during the year can vary significantly. For example, ingestion of agricultural foods may be dependent on the growing season, and the duration of external and inhalation exposure may be limited to account for time spent away from home. For the agricultural pathways, the time frame must account for the change in radionuclide concentrations in various media during holdup and consumption periods after harvest. More complete descriptions of the time frames for the agricultural pathway are given in Sections 5.3 and 5.4. As with the scenarios for release of buildings, the time-dependent concentrations of residual radioactive contamination are evaluated using exposure durations and average concentrations, as appropriate for each pathway. Again, the average concentrations are described using the concentration time-integral operator, $S\{\}$ or $S_{rk}\{\}$ (as discussed in Section 2 and Appendix B), divided by the duration of the exposure period. A detailed discussion of the selection of parameter values for calculating dose from residual soil contamination is provided in Section 6.

5.1.2 Exposure Pathways for the Residential Scenario

As can be inferred from Figure 5.1, numerous potential exposure pathways can be identified for residual radioactive contamination in soil. The potential importance of these pathways depends on several factors, including the nature and distribution of the contamination (i.e., surface or subsurface sources), the radionuclides (i.e., their chemical and physical properties), and the environmental setting (i.e., a humid or arid, warm or cold climate). The potential pathways for human exposure are shown in the following list, with those selected for analysis shown in bold type:

- **external exposure to penetrating radiation from volume soil sources while outdoors**
- **external exposure to penetrating radiation from volume soil sources while indoors**
- external exposure to soil tracked indoors (surface source)
- external exposure to penetrating radiation from submersion in airborne radioactive soil
- external exposure from swimming and shoreline activities associated with a contaminated surface-water source
- **inhalation exposure to resuspended soil while outdoors**
- **inhalation exposure to resuspended soil while indoors**
- **inhalation exposure to resuspended surface sources of soil tracked indoors**
- inhalation of the radon aerosol while outdoors

- inhalation of the radon aerosol while indoors
- **direct ingestion of soil**
- **inadvertent ingestion of soil tracked indoors**
- **ingestion of drinking water from a ground-water source**
- **ingestion of plant products grown in contaminated soil**
- **ingestion of plant products irrigated with contaminated ground water**
- **ingestion of animal products grown onsite (i.e., after the animals ingest contaminated drinking water, plant products, and soil)**
- ingestion of drinking water from a contaminated surface-water source
- **ingestion of fish from a contaminated surface-water source**
- internal contamination from puncture wounds
- dermal absorption of radionuclides.

In addition, within these major pathways there may be several mechanisms for establishing a concentration of radionuclides in a specific medium. For example, food crops can be contaminated by direct root uptake from soil, deposition of resuspended soil on plant surfaces, deposition of radionuclides in irrigation water on plant surfaces, and "rainsplash" (deposition of soil on plant surfaces splashed from rainfall or irrigation). This screening analysis includes direct root uptake, deposition of resuspended radionuclides from soil, and deposition of radionuclides in irrigation water. Rainsplash is not included. The potential importance of rainsplash is related to the type of crop, soil properties, and intensity of the rainfall (or irrigation) events. For some situations, the quantity of material on plant leaves from rainsplash may equal or exceed deposition by other mechanisms. Although rainsplash is not included in this analysis, it is compensated for by assuming that there is no removal of deposited material from plant surfaces during food preparation and through inclusion of a direct soil-ingestion pathway. These assumptions form the prudently conservative basis for the agricultural pathways of the residential scenario. Figure 5.2 shows the relationship of soil contamination to plant and animal products in the agricultural pathways. Note that Figure 5.2 accounts for resuspension of soil contamination in the air and migration of radionuclides in soil to a ground-water source used for irrigation of land and drinking by animals.

The exposure pathways selected for analysis in the residential scenario (shown in bold type in the list above) include external exposure to volume soil sources (for exposures outdoors and indoors), inhalation of resuspended soil (for exposures outdoors and indoors), inhalation of resuspended surface sources of soil tracked indoors, inadvertent ingestion of surface sources of soil (indoors and outdoors, based on the total quantity of soil ingested), ingestion of drinking water from a ground-water source, ingestion of plant products grown in contaminated soil (using irrigation water from the ground-water source), ingestion of animal products grown onsite (after the animals ingest contaminated drinking water, plant products, and soil), and ingestion of fish from a contaminated surface-water source. This set of pathways, along with the selection of prudently conservative parameter values, provides a balanced analysis for

- photon-emitters, through the external exposure pathway

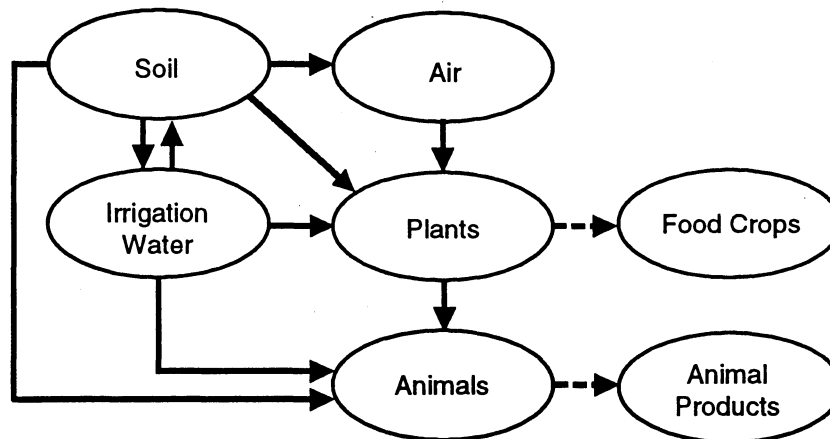

Figure 5.2 Relationship of soil contamination to agricultural pathways

- alpha-emitters, through the inhalation exposure pathway, and
- beta-emitters, through ingestion.

As described in Section 4 and Appendix B, time-dependent concentrations of radionuclides in ground water from surface-soil sources are estimated using a generic three-box water-use model that accounts for leaching of radionuclides.

It should be noted that there are numerous potential exposure pathways that are not included in this generic analysis, although they may be important under some circumstances. Air submersion, internal exposure from puncture wounds, dermal absorption, and inhalation of the radon aerosol are eliminated for the same reasons described in Sections 3.1.2 and 3.2.2 for buildings.

Although direct ingestion of soil is often considered by the EPA in generic situations (EPA 1989), it is an activity typically associated with children and constitutes a worst-case assessment. For purposes of this generic study, it is assumed that everyone inadvertently ingests some soil using assumptions about the total quantity of soil that may be ingested. Additionally, direct soil ingestion by animals is included in the pathway analysis.

Several of the pathways associated with surface-water runoff (i.e., drinking by man and farm animals, irrigation, and external exposure from swimming or shoreline activities) are not included in this study. As with the ground-water pathway, migration of radionuclides from surface soil to surface water is dependent on many conditions that are difficult to capture in a generic model. These conditions include the climate (amount of rainfall), features of the surrounding terrain (distance to the affected surface water and land use), leachability (or solubility) of specific radionuclides, surface-soil erosion rates, and sediment formation. In arid parts of the country, rainfall may move large amounts of soil in a short amount of time (through flash floods). However, evaluation of flash flood events would likely provide a worst-case, not a prudently conservative, analysis. In general, increased dilution occurs with increased distance from an environmental source; therefore, exposures to materials at the contaminated site are likely to exceed those that result from radionuclide migration to the nearby vicinity. Furthermore, the water-use model used in this study does not account for removal of radionuclides through surface runoff and assumes limited dilution in an aquifer of limited size (as described in Section 6). Thus, the water-use model is considered to be a conservative and simple

model when compared with a real situation. Finally, because of the poor quality of most surface water in the United States, it is rarely used directly (without treatment) for drinking by humans. Treating drinking water lowers the concentrations of certain radionuclides. Thus, the potential doses resulting from drinking surface water are assumed to be generally bounded by the drinking water pathway and the water-use model included in this screening analysis.

To produce a more complete set of pathways for the first and second levels of screening, ingestion of fish raised in contaminated water is included in the residential scenario. The concentrations of radionuclides in the fish are determined using a simple bioaccumulation factor and the time-dependent concentration of radionuclides in the surface water. Rather than developing a special surface-water concentration model, the surface-water concentration is determined from the overall water-use model applied to the residential scenario.

The modeling details for the residential scenario exposure pathways are shown in Figure 5.3. This figure serves as a master figure and shows each of the environmental media, exposure pathway models, unit dose factors, and pathway doses used to construct the annual TEDE for the residential scenario. The major media are air (from resuspended soil), soil, and water. The water concentrations and soil concentrations for each year of the model analysis are determined using the water-use model. Boxes are included in Figure 5.3 showing the exposure pathways with a reference to the sections of this report that contain descriptions of the model formulations. The exposure pathways shown in double boxes are described by additional figures that show the details of the pathway analysis and linkages to this master figure. Finally, specific equation numbers are shown in Figure 5.3 to help identify the mathematical formulations used at key points in the exposure pathway analysis.

5.2 Steps for Calculating Annual Dose from Agricultural Pathways

As discussed in the previous section, agricultural pathways for estimating doses from residual radioactive contamination in surface soil are quite complex. In addition to direct uptake by the roots of plants, radionuclides deposited from resuspended soil in air and those deposited in irrigation water can provide additional mechanisms for establishing radionuclide concentrations in plant and animal products. As Figure 5.4 shows, the process of estimating the annual TEDE for the agricultural pathways can be broken into seven steps. The first three steps are used to estimate radionuclide concentrations per unit concentration in soil (dry weight) or water, in plant or animal material, and in food products (using partial pathway transfer factors [PPTFs]). The fourth step is used to estimate the intake of activity from all agricultural pathways as a function of unit concentration in soil (using pathway factors [PFs]). The fifth step is used to account for the dose per unit concentration in soil for root uptake, resuspension or irrigation (using agricultural dose factors [AFs]). The sixth step is used to account for the radionuclide inventory and the CEDE for ingestion of all agricultural foods, and the seventh step is used to account for the annual TEDE by summing over all exposure pathways considered in the residential scenario.

The equations in the following sections describe calculation of the PPTFs for initial unit activity of a parent radionuclide in soil or water. For these calculations, all progeny radionuclides are assumed to have zero initial activity. This convention provides an estimate of PPTFs related to the initial activity of the parent (independent of any assumptions about progeny activities) that can be used in conjunction with measured or estimated activities for a particular site. By calculating PPTF values normalized to the activity present at the beginning of a year, the PPTF values can be applied to any year in the future by multiplying the PPTF values by the activities of the parent and progeny radionuclides present at the beginning of the future year. Contributions from progeny that may be present at the site initially and for each year in the calculation are evaluated using PPTF values for a series of decay chains, each starting with a progeny in the chain as the parent. This is shown by the double-lined boxes in Figure 5.5, which shows the calculations for a decay chain with four members. The example analysis shows a series of four decay chains, one for each chain member as the parent of a shorter chain. In each chain, the decay and progeny in-growth calculations for each

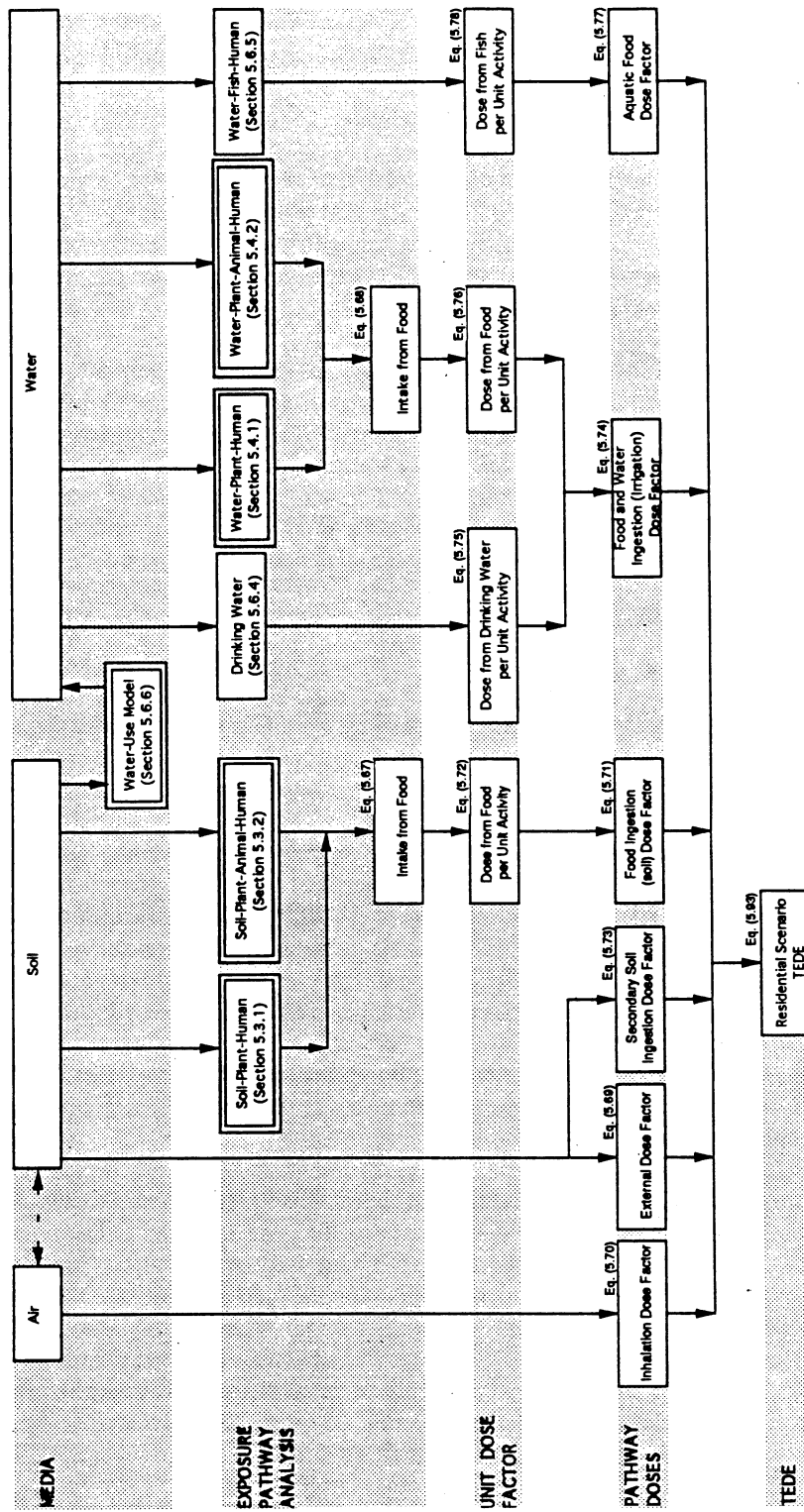

Figure 5.3 Modeling details for the residential scenario exposure pathways

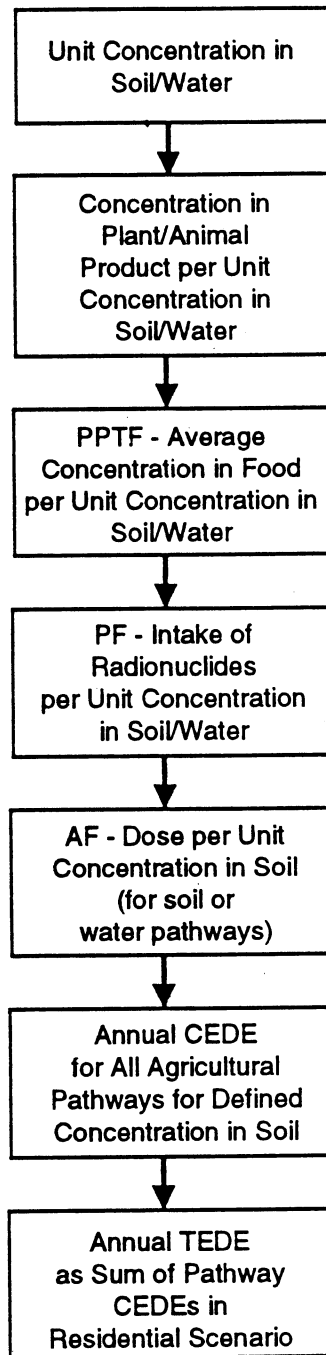

Figure 5.4 Process for estimating annual TEDEs for the agricultural pathways

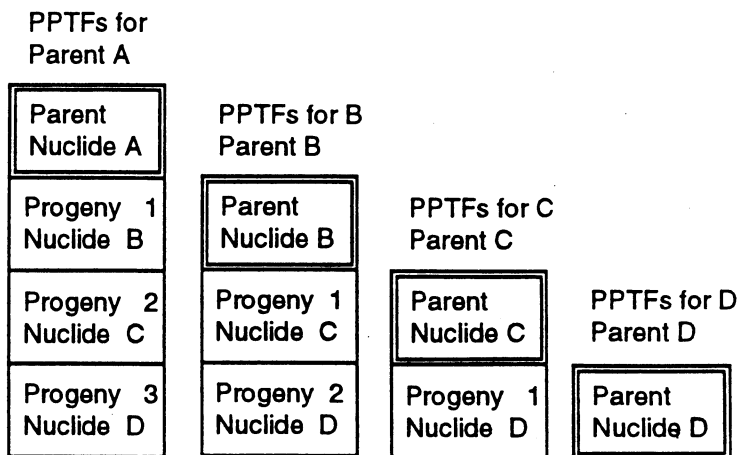

Figure 5.5 PPTF analysis for decay chain radionuclides

year of analysis result in an estimate of the activity of each chain member. Progeny in-growth is shown in Figure 5.5 by the single boxes. The total activity of each chain member at the end of a year is found by summing the activities of each chain member over each of the shorter chains. For example, the activity of radionuclide C present at the end of a year of analysis is the sum of the activity produced by decay of parent B in the decay chain with parents A and B, plus the activity of radionuclide C as a parent remaining after the year of radioactive decay.

Special cases for selected radionuclides are also considered for evaluation of unit TEDE values when secular equilibrium is assumed to occur. The progeny activities for the secular equilibrium cases are determined from the decay chain branching data.

The PPTF evaluations in the following sections relate initial activities in each medium (or average activity in ground water) to the human intake of radionuclides. These analyses are performed for a "current" 1-year period. The doses for future years are evaluated from these "current" year PPTF values, using estimates of initial activity in each medium for the future year. This process is discussed in Section 5.6.6.

The following sections describe the comprehensive models and mathematical formulations used to calculate doses for the agricultural pathways associated with air deposition of resuspended soil, root uptake, and deposition in irrigation water. The transfer of activity from soil to plants includes two pathways: deposition of resuspended particles onto plant surfaces and uptake of activity directly from soil via roots. Both of these transfer mechanisms are included in the models to estimate radionuclide concentrations in plants grown in contaminated soil. The uptake via roots is based on use of concentration ratios between plant and soil. A similar model is used for the resuspension pathway. A plant soil mass-loading parameter is defined that relates the transfer of activity deposited from resuspended soil onto the plant. This approach eliminates the need to define dose parameters based on unit activity in air, as was done in the January 1990 issue of NUREG/CR-5512 (Kennedy and Peloquin 1990). The models used for this pathway are defined in Section 5.3.

5.3 Concentrations and Transfer Factors for Resuspension and Root Uptake From Soil

This section discusses evaluation of PPTFs for the following three pathways: the soil-plant-human pathway, the soil-stored feed-animal-human pathway, and the soil-forage feed-animal-human pathway.

5.3.1 Soil-Plant-Human Pathway

An overview of the modeling processes included in the soil-plant-human pathway is shown in Figure 5.6. The bold box in this figure relates to the double-lined box in master Figure 5.3, showing the overall modeling details for the residential scenario. As shown in Figure 5.6, three significant processes are accounted for in this pathway: 1) calculation of the concentration of radionuclides in plants at the time of harvest (accounting for root uptake and deposition from resuspended soil), 2) calculation of the concentration at the start of the consumption period (accounting for radioactive decay during holdup), and 3) calculation of the time integral of activity in consumed food (calculation of the partial pathway transfer factor for the soil-plant-human pathway). Equation numbers are included in Figure 5.6 to help identify the specific mathematical formulations used in the models. Figure 5.6 also shows linkages to the other significant processes needed to estimate the annual TEDE for the residential scenario. The double-lined boxes in Figure 5.6 show linkages to the other pathways considered in the residential scenario.

The transfer of radionuclides from soil to plants is evaluated for an initial unit concentration of a parent radionuclide in the soil at the start of the growing period. The assumptions for the soil-to-food-crop pathway are as follows:

- Parent radionuclide concentration in soil is defined at the start of the crop-growing period.
- The plant concentration for each decay chain member radionuclide is in equilibrium with the soil concentration at all times.
- The concentration of radionuclides in edible parts of the plant at the end of the first growing period (i.e., first crop) is used as the harvest concentration. Multiple harvesting of plant crops is not addressed.
- The harvested crops are held for a short holdup time before being consumed by humans. The concentration at harvest is reduced by radioactive decay during the holdup time.
- The consumption period by an individual for plant food crops is taken to be 1 year. Radioactive decay during the consumption period is accounted for in the intake calculation.

Figure 5.7 illustrates the change in relative concentration in soil and plants (v) as a function of time. The concentrations of parent radionuclides in soil and food decrease with time because of radioactive decay. The relative concentrations in Figure 5.7 have similar shapes because the plant concentration is assumed to be in constant equilibrium with the soil concentration.

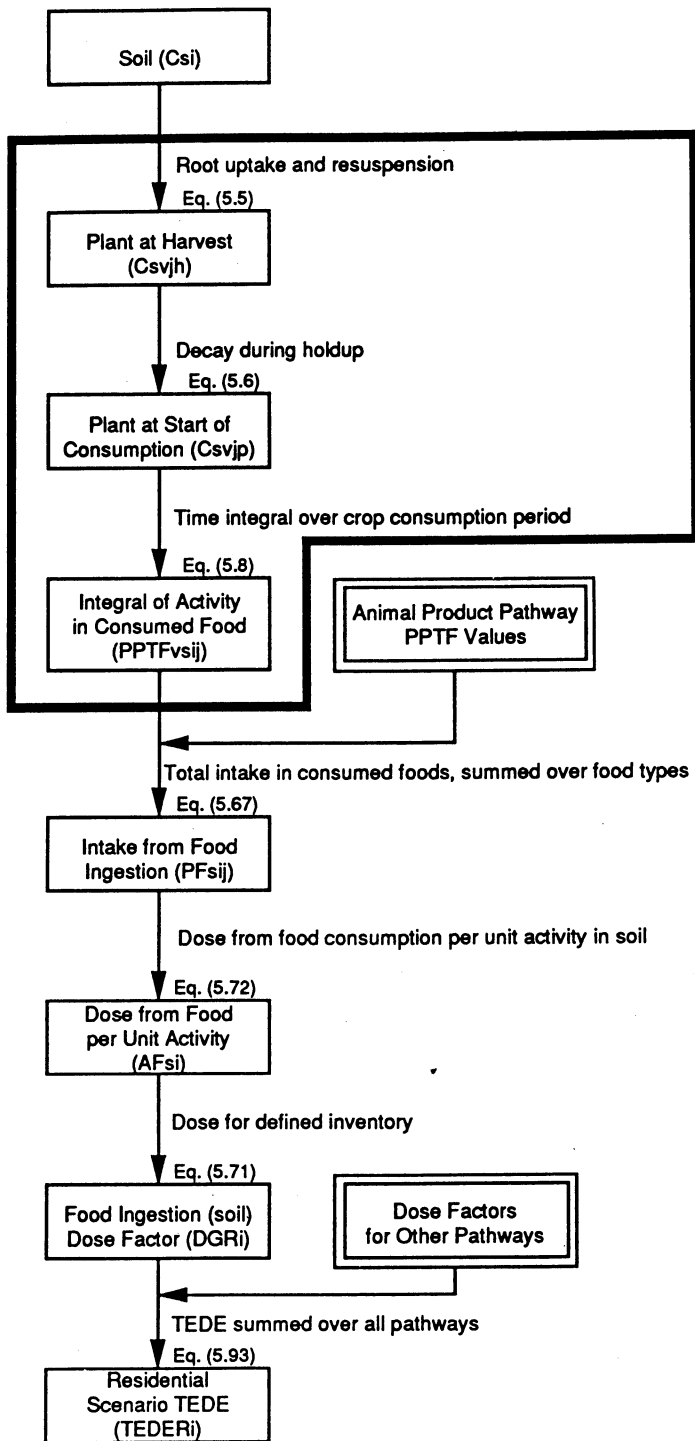

Figure 5.6 Soil-plant-human pathway

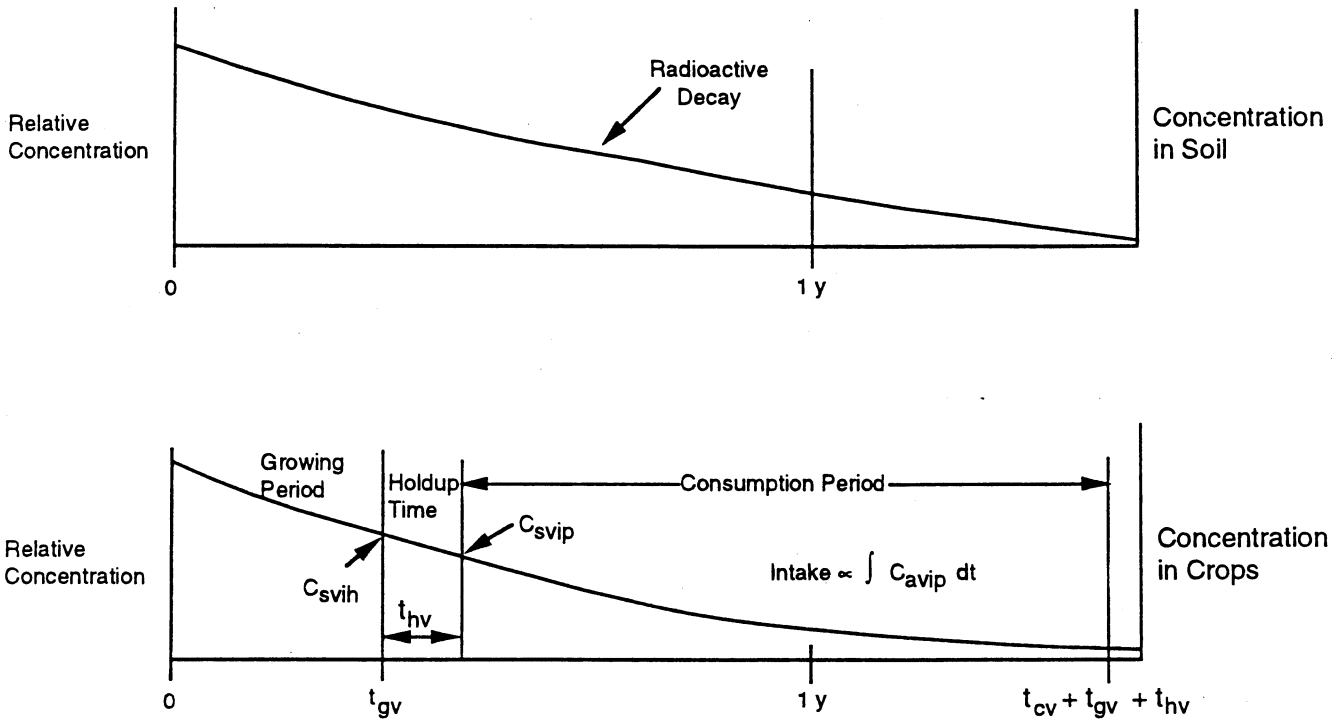

Figure 5.7 Change in relative concentrations over time for soil and plant crops from root uptake

The differential equation defining the change of radionuclide concentration in soil is represented as follows:

$$\frac{dC_{sj}(t)}{dt} = \sum_{n=1}^{j-1} d_{nj} \lambda_{rj} C_{sn} \frac{dC_{sn}(t)}{dt} - \lambda_{rj} C_{sj}(t) \quad (5.1)$$

where $C_{sj}(t)$ = concentration of radionuclide j in soil during the growing period (pCi/g dry soil)

$C_{sn}(t)$ = concentration of radionuclide n in soil during the growing period (pCi/g dry soil)

d_{nj} = decay branching fraction for transitions of radionuclide n to radionuclide j (dimensionless)

λ_{rj} = decay rate constant for radionuclide j (d^{-1}).

The solution to the above equation is evaluated using the decay equations described in Appendix B. The solution to Equation (5.1) can be written as follows:

for the parent ($j=1$),

$$C_{s1}(t) = C_{s1}(0) e^{-\lambda_{r1}t} \quad (5.2)$$

Residential

and for the first progeny (J=2),

$$C_{s2}(t) = \frac{d_{12}\lambda_{r2}C_{s1}(0)}{\lambda_{r2} - \lambda_{r1}} e^{-\lambda_{r1}t} + \left[C_{s2}(0) - \frac{d_{12}\lambda_{r2}C_{s1}(0)}{\lambda_{r2} - \lambda_{r1}} \right] e^{-\lambda_{r2}t} \quad (5.3)$$

where $C_{s1}(0)$, $C_{s2}(0)$, $C_{s1}(t)$, and $C_{s2}(t)$ represent the initial concentration of a radionuclide in soil and the concentration at time t, respectively.

The solutions shown by Equations (5.2) and (5.3) can be represented in decay operator notation as follows:

$$A\{C_{sj}, t\} \quad (5.4)$$

where $A\{C_{sj}, t\}$ = decay operator notation for evaluation of chain member radionuclide concentrations in soil after decay for a time period t (pCi/g dry soil).

This notation is used extensively in the following presentation of models for the agricultural pathways. Details of the decay operator equations are given in Appendix B with a sample application showing the generation of Equations (5.2) and (5.3) in Section B.2.2.

The concentration factors for parent and progeny radionuclides in edible parts of the plant at the time of harvest are evaluated by the following equation:

$$C_{svjh} = 1000 (ML_v + B_{jv}) W_v A\{C_{sj}, t_{gv}\} / C_{si}(0) \quad (5.5)$$

where C_{svjh} = concentration factor for radionuclide j in plant v at harvest from an initial unit concentration of parent radionuclide i in soil (pCi/kg wet-weight plant per pCi/g dry-weight soil)

B_{jv} = concentration factor for uptake of radionuclide j from the soil in plant v (pCi/kg dry-weight plant per pCi/kg dry-weight soil)

ML_v = plant soil mass-loading factor for resuspension of soil to plant type v (pCi/kg dry-weight plant per pCi/kg dry-weight soil)

W_v = dry-weight-to-wet-weight conversion factor for plant v (kg dry-weight plant per kg wet-weight plant)

$A\{C_{sj}, t_{gv}\}$ = decay operator notation used to develop the concentration of radionuclide j in soil at the end of the crop-growing period, t_{gv} (pCi/g dry weight soil)

C_{sj} = ^{initial} concentration of radionuclide j in soil ^{at start of} during the growing period (pCi/g dry-weight soil)

$C_{si}(0)$ = initial concentration of parent radionuclide i in soil (pCi/g dry-weight soil)

t_{gv} = growing period for food crop v (d)

1000 = unit conversion factor (g/kg).

The plant soil mass-loading factor represents transfer of activity from soil to plants via resuspension and deposition. This approach has been suggested by Martin and Bloom (1980) and Pinder and McLeod (1989) for estimating radionuclide concentrations in plants for cases in which the root uptake pathway is not significant. Numerical values for the plant soil mass-loading factor are discussed in Section 6.

Equation (5.5) contains the ratio of two concentration parameters: C_{sj} in the decay operator and $C_{si}(0)$ in the denominator. This ratio represents normalization of plant concentration to unit initial concentration of parent radionuclide in soil. The concentration of decay-chain-member radionuclide j (C_{sj}) is evaluated from the initial concentration of parent radionuclide i using decay equations given in Appendix B and represented in Equation (5.5) by the decay operator, $A\{\}$.

The radionuclide concentration in the plant undergoes radioactive decay during the holdup period following harvest according to the following equation:

$$C_{svjp} = A \{C_{svjh}, t_{hv}\} \quad (5.6)$$

where C_{svjp} = concentration factor for radionuclide j after decay during the holdup period (to the start of the consumption period) for plant v , for initial unit concentration of parent radionuclide i in soil (pCi/kg wet-weight plant per pCi/g dry-weight soil)

$A \{C_{svjh}, t_{hv}\}$ = decay operator notation used to develop the concentration factor for radionuclide j after decay during the holdup period (to the start of the consumption period) for plant v , for initial unit concentration of parent radionuclide i in soil (pCi/kg wet-weight plant per pCi/g dry-weight soil)

t_{hv} = holdup time between harvest and human consumption of food crop v (d).

Equation (5.6) may be expressed for the parent radionuclide ($j=1$) as follows:

$$C_{sv1p} = C_{sv1h} e^{-\lambda_{r1} t_{hv}} \quad (5.7)$$

where C_{sv1p} = concentration factor for the parent radionuclide (first member of the decay chain) after decay during the holdup period for plant v , for an initial unit concentration of parent radionuclide i in soil (pCi/kg wet-weight plant per pCi/g dry-weight soil)

C_{sv1h} = concentration factor for the parent (first member of the decay chain) in plant v at harvest for an initial unit concentration of the parent radionuclide in soil (pCi/kg wet-weight plant per pCi/g dry-weight soil)

and other terms are as previously defined.

Consumption is assumed to occur over an extended time period, t_{cv} . The time integral of concentration in the food crop, $S\{C_{svjp}, t_{cv}\}$, is evaluated between the start of consumption, defined by the growing period and minimum holdup time, and the end of consumption, as defined for each type of plant. The time integral of radionuclide concentration in a plant over the consumption period t_{cv} , which is equivalent to the PPTF, is evaluated as follows:

Residential

$$\text{PPTF}_{\text{vsij}} = S \{C_{\text{svjp}}, t_{\text{cv}}\} / 365.25 \quad (5.8)$$

where $\text{PPTF}_{\text{vsij}}$ = partial pathway transfer factor for plant v, for radionuclide j as a progeny of radionuclide i, for unit initial concentration of parent radionuclide i in soil (pCi•y/kg wet-weight plant per pCi/g dry-weight soil for a year of residential scenario)

$S\{C_{\text{svjp}}, t_{\text{cv}}\}$ = time-integral operator used to develop the concentration time-integral factor for radionuclide j over the consumption period of plant v for the soil pathway, for initial unit concentration of parent radionuclide i in soil (pCi•d/kg wet-weight plant per pCi/g dry-weight soil for a year of residential scenario)

t_{cv} = consumption period of plant v by humans (d for a year of residential scenario)

365.25 = unit conversion factor (d/y).

The PPTF expression in Equation 5.8 can be expanded using expressions for the time-integral operator notation as follows:

for the parent,

$$\text{PPTF}_{\text{vs11}} = \frac{C_{\text{sv1p}}}{365.25} \left[\frac{1 - e^{-\lambda_{r1} t_{\text{cv}}}}{\lambda_{r1}} \right] \quad (5.9)$$

and for the first progeny (j=2),

$$\begin{aligned} \text{PPTF}_{\text{vs12}} = \frac{1}{365.25} & \left[\frac{d_{12} \lambda_{r2} C_{\text{sv1p}}}{(\lambda_{r2} - \lambda_{r1})} \left(\frac{1 - e^{-\lambda_{r1} t_{\text{cv}}}}{\lambda_{r1}} \right) \right. \\ & \left. + \left(C_{\text{sv2p}} - \frac{d_{12} \lambda_{r2} C_{\text{sv1p}}}{\lambda_{r2} - \lambda_{r1}} \right) \left(\frac{1 - e^{-\lambda_{r2} t_{\text{cv}}}}{\lambda_{r2}} \right) \right] \end{aligned} \quad (5.10)$$

where $\text{PPTF}_{\text{vs11}}$ = PPTF value for the parent radionuclide, i=j=1 (pCi• y/kg wet-weight plant per pCi/g dry-weight soil for a year of residential scenario)

$\text{PPTF}_{\text{vs12}}$ = PPTF value for the first progeny (j=2), for unit initial concentration of parent radionuclide, i=1 (pCi• y/kg wet-weight plant per pCi/g dry-weight soil for a year of residential scenario)

and other terms are as previously defined. The time-integral operator notation is defined in Section B.1.1 and derived in Section B.3.

5.3.2 Animal Products Contaminated by Soil Sources

This section describes the calculation of the PPTF values for the soil-stored feed-animal-human pathway and the soil-forage feed-animal-human pathway. An overview of the modeling processes included in the soil-plant-animal-human

pathway is shown in Figure 5.8. The bold box in this figure relates to the double-lined box in master Figure 5.3, showing the overall modeling details for the residential scenario. As shown in Figure 5.8, three significant processes are accounted for in this pathway: 1) calculation of the concentration of radionuclides in plants used for animal forage, hay, or grain at the time of harvest (accounting for root uptake and deposition from resuspended soil), 2) calculation of the concentration in forage, stored hay, stored feed, and soil at the start of the animal feeding period (accounting for radioactive decay), and 3) calculation of the time integral of activity over all animal intake routes (calculation of the PPTF for the soil-plant-animal-human pathway). Equation numbers are included in Figure 5.8 to help identify the specific mathematical formulations used in the models. Figure 5.8 also shows linkages to the other significant processes needed to estimate the annual TEDE for the residential scenario. The double-lined boxes in Figure 5.8 show linkages to the other pathways considered in the residential scenario.

The assumptions for the pathways are as follows:

- Parent radionuclide concentration in soil is defined at the start of the crop growing period.
- Fresh forage crops are eaten by the animal continuously (starting at time zero) over the entire feeding period of the animal.
- Stored feed crops are eaten continuously during a feeding period offset by the stored feed crop's growing period (i.e., feeding begins at crop harvest).
- The harvested crops (fresh and stored) are immediately available for feeding to animals. (No holdup period is used.)
- A representative mix of fresh and stored feeds is assumed for each type of animal product, constant over the feeding period. These are described in Section 6.
- Stored feeds may consist of hay and/or grain.
- Instantaneous equilibrium occurs between the radionuclide concentration in the soil and the concentration in the plants (fresh forage and stored feed plants).
- Instantaneous equilibrium occurs between daily intake in the feed and radionuclide concentrations in the animal products.
- Animal products are harvested (e.g., milked, slaughtered, or eggs gathered) continuously over the feeding period and then distributed for human consumption.
- The human consumption period is equal in length to the feeding period for each animal product type, offset by the time between harvest and consumption.
- Decay during the holdup time between animal product harvest and consumption by humans is evaluated.

5.3.2.1 Soil-Stored Hay-Animal-Human Pathway

Figure 5.9 illustrates the variation of the relative parent radionuclide concentration in soil, stored hay plants, and animals as a function of time. In this pathway, the stored hay plants are contaminated by resuspension and root uptake from soil. Radionuclide concentrations in stored hay plants from soil uptake are evaluated using Equation (5.7). The

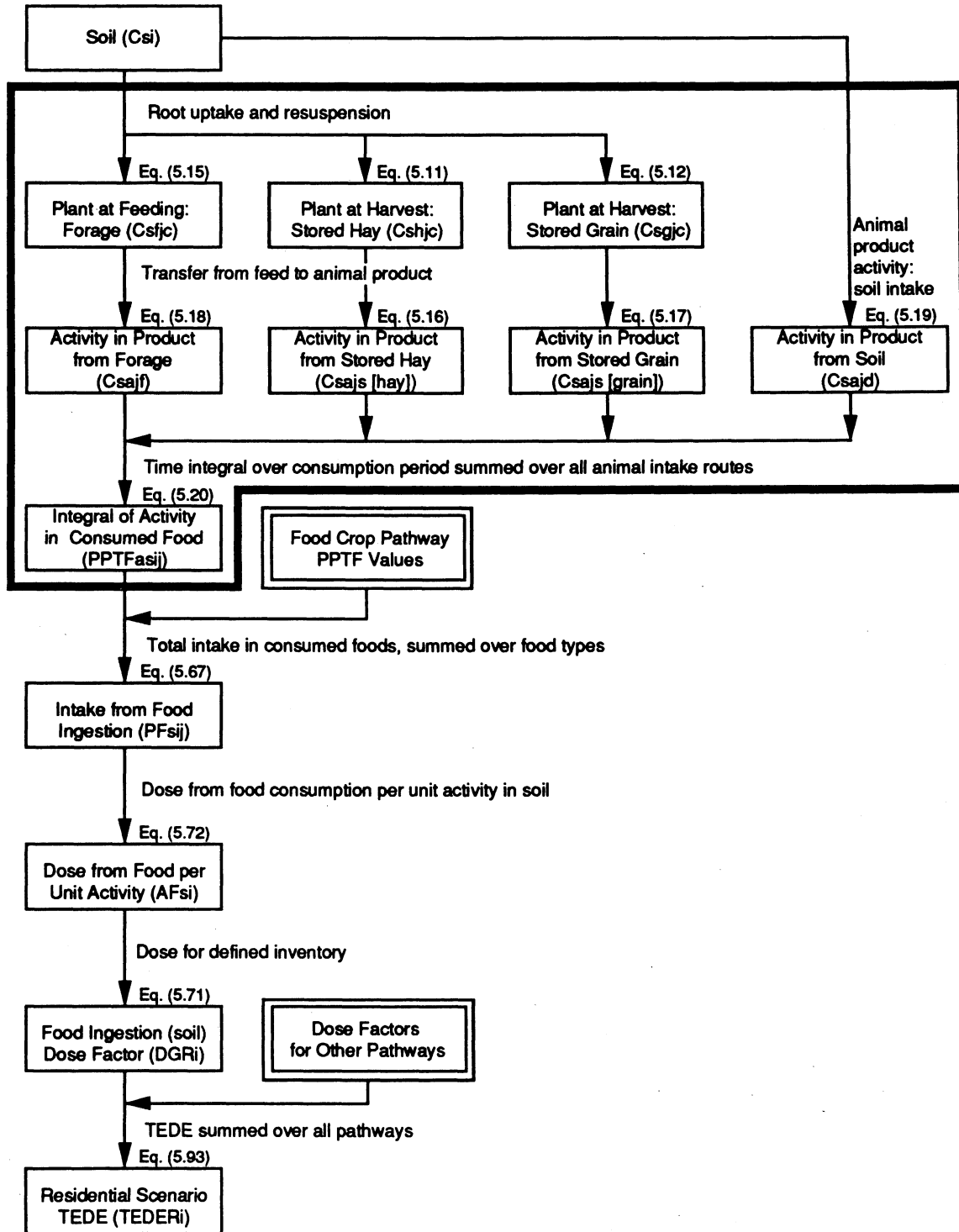

Figure 5.8 Soil-plant-animal-human pathway

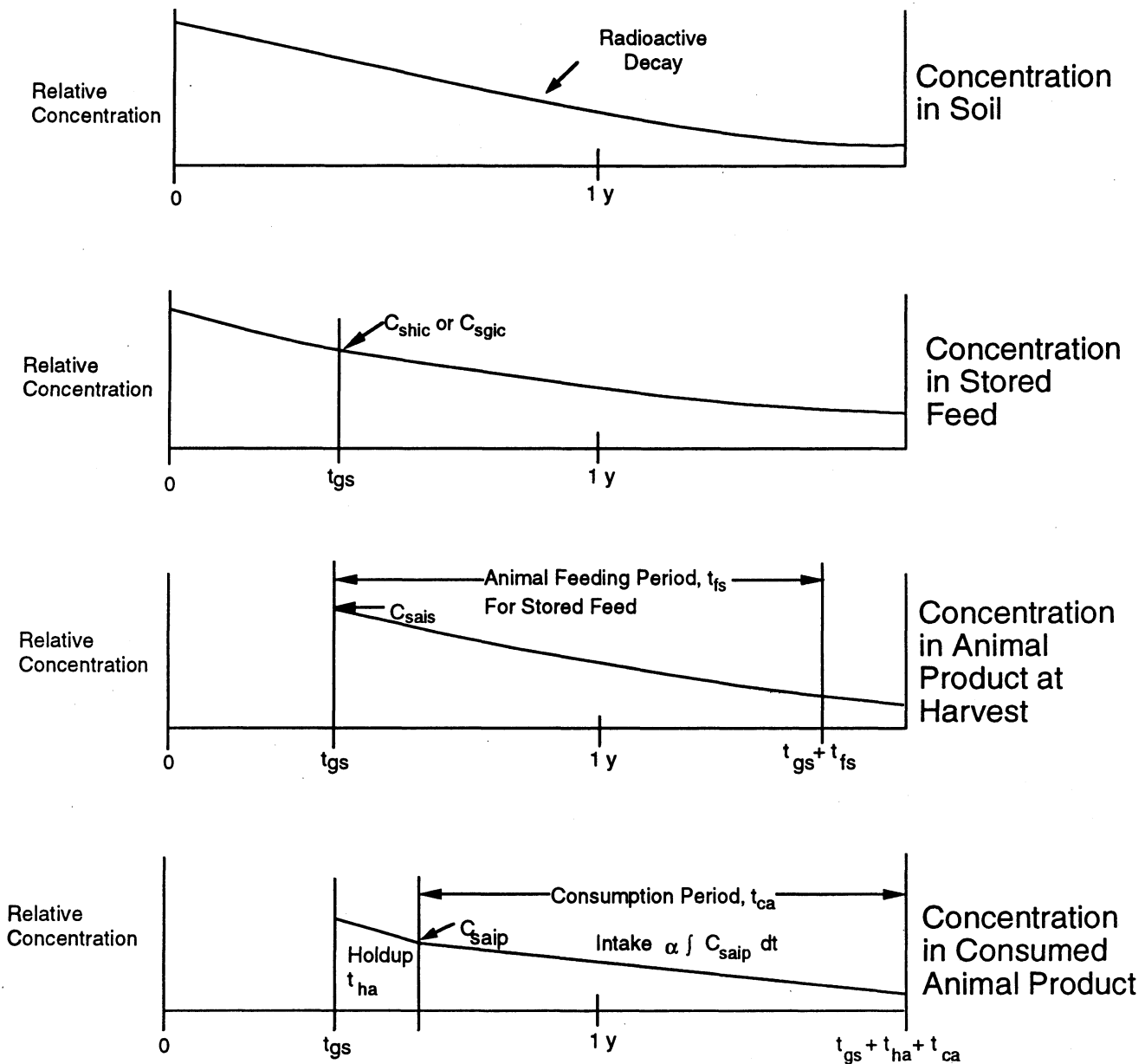

Figure 5.9 Change in relative concentrations over time for soil, stored feed, animal products, and human foods from the root-uptake pathway

appropriate stored hay crop parameters are used. The radionuclide concentration in stored hay from resuspension and root uptake from soil is evaluated as follows based on equilibrium with the concentration in soil:

$$C_{shjc} = 1000 (ML_h + B_{jh}) W_h A\{C_{sj}, t_{gh}\} / C_{si}(0) \quad (5.11)$$

where C_{shjc} = concentration factor for radionuclide j in stored hay crop h at time of initial feeding to animals from an initial unit concentration of parent radionuclide i in soil (pCi/kg wet-weight plant per pCi/g dry-weight soil)

B_{jh} = concentration factor for uptake of radionuclide j from the soil in stored hay crop h (pCi/kg dry-weight plant per pCi/kg dry-weight soil)

ML_h = plant soil mass-loading factor for resuspension of soil onto hay plant h (pCi/kg dry-weight plant per pCi/kg dry-weight soil)

W_h = dry-weight-to-wet-weight conversion factor for stored hay crop h (kg dry-weight hay per kg wet-weight hay)

$A\{C_{sj}, t_{gh}\}$ = decay operator notation used to develop the concentration of radionuclide j in soil at the end of the hay-crop growing season, t_{gh} (pCi/g dry-weight soil)

C_{sj} = ^{initial} concentration of radionuclide j in soil ^{at start of} during the growing period (pCi/g dry-weight soil)

$C_{si}(0)$ = initial concentration of parent radionuclide i in soil at start of growing period (pCi/g dry-weight soil)

t_{gh} = growing period for stored hay crop h (d)

1000 = unit conversion factor (g/kg)

and other terms are as previously defined.

For stored hay, the concentration is defined at the time of crop harvest (see Equation [5.11]), which is also assumed to be the time at which feeding to animals begins (i.e., there is assumed to be no holdup between feed harvest and start of feeding).

5.3.2.2 Soil-Stored Grain-Animal-Human Pathway

The evaluations for radionuclide concentrations in stored grain are analogous to those for stored hay, as defined in the previous section. The equation for radionuclide concentration at the beginning of the feeding period is evaluated using Equation (5.11) with the subscript "h" (for hay) replaced by "g" (for grain). The resulting equation for radionuclide concentration in stored grain from resuspension and root uptake from soil is evaluated as follows, based on equilibrium with the concentration in soil:

$$C_{sgjc} = 1000 (ML_g + B_{jg}) W_g A\{C_{sj}, t_{gg}\} C_{si}(0) \quad (5.12)$$

- where C_{sgjc} = concentration factor for radionuclide j in stored grain crop g at time of initial feeding to animals from an initial unit concentration of parent radionuclide i in soil (pCi/kg wet-weight plant per pCi/g dry-weight soil)
- B_{jg} = concentration factor for uptake of radionuclide j from the soil into stored grain crop g (pCi/kg dry-weight plant per pCi/kg dry-weight soil)
- ML_g = plant soil mass-loading factor for resuspension of soil onto grain plant g (pCi/kg dry-weight plant per pCi/kg dry-weight soil)
- W_g = dry-weight-to-wet-weight conversion factor for stored grain crop g (kg dry-weight grain per kg wet-weight grain)
- $A\{C_{sj}, t_{gg}\}$ = decay operator notation used to develop the concentration of radionuclide j in soil at the end of the crop-growing season, t_{gg} (pCi/g dry-weight soil)
- t_{gg} = growing period for stored grain crop g (d)
- 1000 = unit conversion factor (g/kg)

and other terms are as previously defined.

For stored grain, the concentration is defined at the time of crop harvest (see Equation [5.12]), which is also assumed to be the time at which feeding to animals begins (i.e., there is assumed to be no holdup between feed harvest and start of feeding).

5.3.2.3 Soil-Forage Feed-Animal-Human Pathway

Figure 5.10 illustrates the variation of the relative parent radionuclide concentration in soil, fresh forage plants, and animals as a function of time. In this pathway, fresh forage consumed by animals is contaminated by resuspension and root uptake from soil. The animal product activity from the forage crop pathway is proportional to the soil concentration at all times during the feeding period. This is because of the assumptions of equilibrium between soil and forage plant and between forage plant intake and animal product. The animal is assumed to consume the fresh forage continuously over the grazing period with no delay time between harvest and feeding.

The concentration in forage consumed by the animal (at any time) is evaluated as follows:

$$C_{sfjt} = 1000 (ML_f + B_{jf}) W_f A\{C_{sj}, t\} / C_{si}(0) \quad (5.13)$$

where C_{sfjt} = concentration factor for radionuclide j in fresh forage crop f at time t , from an initial unit concentration of parent radionuclide i in soil (pCi/kg wet-weight plant per pCi/g dry-weight soil)

B_{jf} = concentration factor for uptake of radionuclide j from the soil in fresh forage crop f (pCi/kg dry-weight plant per pCi/kg dry-weight soil)

ML_f = plant soil mass-loading factor for resuspension of soil onto forage plant f (pCi/kg dry-weight plant per pCi/kg dry-weight soil)

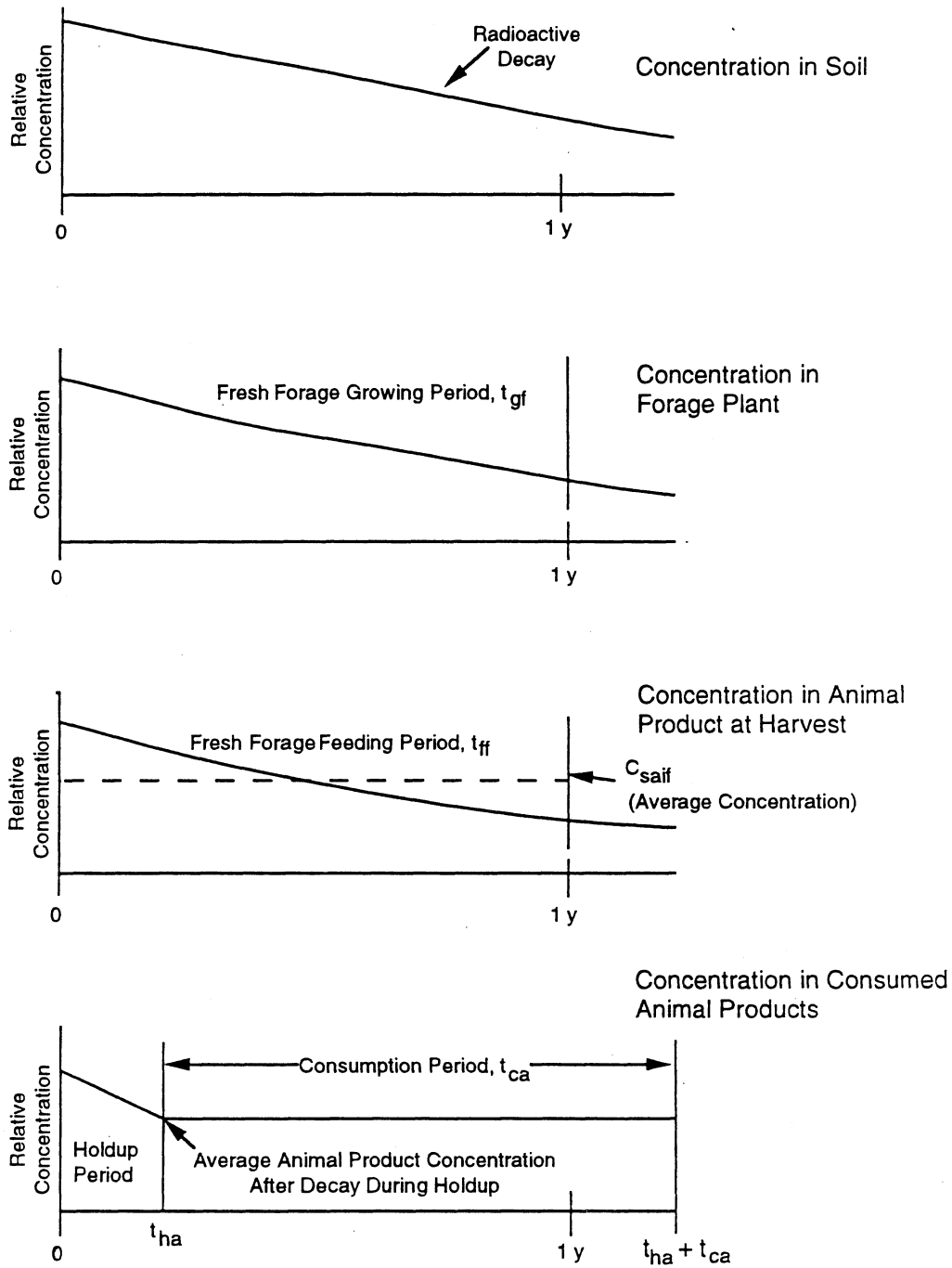

Figure 5.10 Changes in relative concentrations over time for soil, fresh feed, animal products, and human foods from the root uptake pathway

W_f = dry-weight-to-wet-weight conversion factor for fresh forage crop f (kg dry-weight forage per kg wet-weight forage)

$A\{C_{sj},t\}$ = decay operator notation used to develop the concentration of radionuclide j in soil at time t during the feeding period for fresh forage crop f (pCi/g dry-weight soil)

t = any point in time during the fresh-forage feeding period (d)

and other terms are as previously defined. Equation (5.13) provides the fresh forage concentration as a function of time during the fresh forage feeding period, t_{ff} . The integral of this equation divided by the feeding period provides the average plant concentration over the feeding period. The integral of the forage plant concentration over the feeding period can be expressed in operator notation as follows:

$$\int_0^{t_{ff}} C_{sfjt} dt = \int_0^{t_{ff}} A\{C_{sj},t\} dt = S\{C_{sj},t_{ff}\} \quad (5.14)$$

where terms are as previously defined. Using this expression and dividing by the feeding period, t_{ff} , the average plant concentration is evaluated as follows:

$$C_{sfjc} = 1000 (ML_f + B_{jf}) W_f S\{C_{sj},t_{ff}\} / [t_{ff} C_{si}(0)] \quad (5.15)$$

where C_{sfjc} = average concentration factor for radionuclide j in fresh forage crop f over the feeding period at time of animal consumption of forage from an initial unit concentration of parent radionuclide i in soil (pCi/kg wet-weight plant per pCi/g dry-weight soil)

$S\{C_{sj},t_{ff}\}$ = concentration time-integral factor for radionuclide j in soil over the feeding period, t_{ff} (pCi•d/g dry-weight soil)

t_{ff} = feeding period for forage crop f (d)

and other terms are as previously defined.

5.3.2.4 Calculation of PPTFs for Animal Products Contaminated by Soil

The animal product concentration factor is proportional to the plant concentration factor. The animal product concentration factor for stored hay intake is

$$C_{sajs(hay)} = F_{aj} Q_h x_h C_{shjc} \quad (5.16)$$

For stored grain the animal concentration factor is

$$C_{sajs(grain)} = F_{aj} Q_g x_g C_{sgjc} \quad (5.17)$$

and for fresh forage the average animal product concentration factor is

$$C_{sajf} = F_{aj} Q_f x_f C_{sfjc} \quad (5.18)$$

where $C_{sajs(\text{hay})}$ = concentration factor for animal product a, at initial time of feeding of stored hay for radionuclide j for initial unit concentration of parent radionuclide i in soil (pCi/kg wet-weight hay [or pCi/L for milk] per pCi/g dry-weight soil)

$C_{sajs(\text{grain})}$ = concentration factor for animal product a, at initial time of feeding of stored grain for radionuclide j for initial unit concentration of parent radionuclide i in soil (pCi/kg wet-weight grain [or pCi/L for milk] per pCi/g dry-weight soil)

C_{sajf} = average concentration factor for animal product a, over time period of feeding of fresh forage for radionuclide j for initial unit concentration of parent radionuclide i in soil (pCi/kg wet-weight animal product [or pCi/L for milk] per pCi/g dry-weight soil)

F_{aj} = transfer coefficient that relates daily intake in animal feed and ingested soil to the concentration of radionuclide j in an animal product a (pCi/L per pCi/d for milk or pCi/kg wet-weight animal product per pCi/d for other animal products)

Q_f = consumption rate of fresh forage by the animal (kg wet-weight plant/d)

Q_g = consumption rate of stored grain by the animal (kg wet-weight plant/d)

Q_h = consumption rate of stored hay by the animal (kg wet-weight plant/d)

x_f = fraction of animal forage intake that is contaminated (dimensionless)

x_g = fraction of animal stored grain intake that is contaminated (dimensionless)

x_h = fraction of animal stored hay intake that is contaminated (dimensionless)

and other terms are as previously defined. Note that the concentration factors for stored feeds are evaluated at the time of initial feeding to animals; for forage crops, the factor represents an average over the feeding (grazing) period. This difference is important to the evaluation of the PPTF contribution from each pathway (see Equation [5.20]).

Animals on fresh forage may also take in soil while grazing. The amount of soil ingested is assumed to be a constant fraction of the fresh forage intake rate, Q_f , expressed per kg dry weight. The average concentration in animal products from intake during the feeding period is evaluated in the same way as the average feed intakes of Equations (5.15) and (5.18):

$$C_{sajd} = 1000 F_{aj} Q_d W_f Q_f x_f S \{ C_{sj}, t_{ff} \} / [t_{ff} C_{si}(0)] \quad (5.19)$$

where C_{sajd} = average concentration factor for animal product a, over the fresh forage feeding period for soil ingestion by animals for radionuclide j for initial unit concentration of parent radionuclide i in soil (pCi/kg wet-weight animal product per pCi/g dry-weight soil)

Q_d = soil intake as a fraction of forage intake for the animal (kg dry-weight soil per kg dry-weight forage)

and other terms are as previously defined. The ratio of $S\{\}$ to time represents the average concentration of soil-contaminated crops for plant material taken in by the animal over the feeding or grazing period.

To evaluate the PPTF from animal products for the soil pathway, the animal product concentration at time of human consumption is estimated as the sum of contributions from the two feed types and soil. First, the decay between harvest and consumption by humans is evaluated for the average animal product concentration for each feed type, and then the total intake by humans is evaluated. For the forage pathway and soil ingestion, the total intake is calculated as the product of average concentrations multiplied by the time period of intake (consumption period). For the stored feed pathways, the total intake is evaluated as a time integral using the time-integral operator:

$$\begin{aligned} \text{PPTF}_{\text{asij}} = & \left[S \left\{ A \left\{ C_{\text{sajs(hay)}, t_{\text{ha}}}, t_{\text{ca}} \right\} + S \left\{ A \left\{ C_{\text{sajs(grain)}, t_{\text{ha}}}, t_{\text{ca}} \right\} + A \left\{ C_{\text{sajf}, t_{\text{ha}}}, t_{\text{ca}} \right\} \right. \right. \\ & \left. \left. + A \left\{ C_{\text{sajd}, t_{\text{ha}}}, t_{\text{ca}} \right\} \right\} / 365.25 \right] \end{aligned} \quad (5.20)$$

where $\text{PPTF}_{\text{asij}}$ = partial pathway transfer factor for animal product a, for radionuclide j as a progeny of radionuclide i for an initial unit concentration of parent radionuclide i in soil (pCi•y/L for milk and pCi•y/kg for other animal products per pCi/g dry-weight soil for a year of residential scenario)

$A\{C_{\text{sajs(hay)}, t_{\text{ha}}}\}$ = decay operator notation used to develop the concentration factor for radionuclide j in animal product a, from stored-hay intake after decay during holdup (t_{ha}) for initial unit concentration of parent radionuclide i in soil (pCi/kg wet-weight animal product per pCi/g dry-weight soil)

$A\{C_{\text{sajs(grain)}, t_{\text{ha}}}\}$ = decay operator notation used to develop the concentration factor for radionuclide j in animal product a, from stored grain intake after decay during holdup (t_{ha}) for initial unit concentration of parent radionuclide i in soil (pCi/kg wet-weight animal product per pCi/kg dry-weight soil)

$A\{C_{\text{sajf}, t_{\text{ha}}}\}$ = decay operator notation used to develop the concentration factor for radionuclide j in animal product a, from fresh forage intake after decay during holdup (t_{ha}) for initial unit concentration of parent radionuclide i in soil (pCi/kg wet-weight animal product per pCi/g dry-weight soil)

$A\{C_{\text{sajd}, t_{\text{ha}}}\}$ = decay operator notation used to develop the concentration factor for radionuclide j in animal product a, from soil ingestion while grazing, after decay during holdup (t_{ha}) for initial unit concentration of parent radionuclide i in soil (pCi/kg wet-weight animal product per pCi/g dry-weight soil)

$S\{A\{\}, t_{\text{ca}}\}$ = time-integral operator notation used to develop the concentration time-integral factor for radionuclide j in animal product a, over the consumption period by humans for initial unit concentration of parent radionuclide i in soil (pCi•d/kg per pCi/g dry-weight soil for a year of residential scenario)

t_{ca} = consumption period for animal product a (d for a year of residential scenario)

t_{ha} = holdup time for animal product a between harvest and consumption by humans (d)

365.25 = unit conversion factor (d/y).

A description of nested operator notation (e.g., $S\{A\}$) is given in Section 2.2, and an example case is described in Section 5.4.1.3.

5.4 Concentrations and Transfer Factors for Irrigation Water as the Contaminating Medium

Use of contaminated water in sprinkler-type irrigation systems results in deposition of radionuclides directly onto plant surfaces or to the soil with subsequent resuspension and plant uptake and transfer to edible parts of the plant. The contaminated plant can then be eaten by humans or animals, resulting in the same exposure pathways as defined above for air and soil. Material deposited on soil may also be ingested directly by animals while grazing. Using the average water concentrations provided by the water-use model, evaluations are made for each year that doses are to be evaluated.

5.4.1 Food Crops Contaminated by Irrigation Water

Two pathways are used for estimating radionuclide transfer from irrigation water to food crops: deposition directly onto plant leaves (the irrigation water-plant-human pathway) and deposition onto soil with uptake via roots to food crops (the irrigation water-soil-plant-human pathway). An overview of the modeling processes included in the water-plant-human pathway and the water-soil-plant-human pathway is shown in Figure 5.11. The bold box in this figure relates to the double-lined box in master Figure 5.3, showing the overall modeling details for the residential scenario. As shown in Figure 5.11, three significant processes are accounted for in this pathway: 1) calculation of the deposition of radionuclides onto plants and soil with calculation of the concentration at the time of harvest, 2) calculation of the concentration in plants at the time of harvest (accounting for root uptake and for radioactive decay during holdup), and 3) calculation of the time integral of activity over all food consumption routes (calculation of the PPTF for these pathways). Equation numbers are included in Figure 5.11 to help identify the specific mathematical formulations used in the models. Figure 5.11 also shows linkages to the other significant processes needed to estimate the annual TEDE for the residential scenario. The double-lined boxes in Figure 5.11 show linkages to the other pathways considered in the residential scenario.

The assumptions for evaluation of these pathways are as follows:

- The concentration of radionuclides in irrigation water is constant over the year of irrigation (i.e., an average water concentration is used).
- Material deposited on plant surfaces is removed at a constant weathering half-time.
- Radionuclide concentrations in soil from deposition are immediately in equilibrium with radionuclide concentrations in edible portions of the plants grown in the soil.
- Harvested plants are held for a short period of time (holdup time) before being consumed by humans.

5.4.1.1 Irrigation Water-Plant-Human Pathway

Figure 5.12 illustrates the variation over time of the relative parent radionuclide concentration in irrigation water, growing plants, and consumed plants for the water-plant-human pathway. The concentration in water is constant over the year of exposure. The concentration in plants increases as material is deposited onto plant surfaces and is incorporated into edible parts of the plant. After harvest of the food crop, the concentration decays during the holdup time

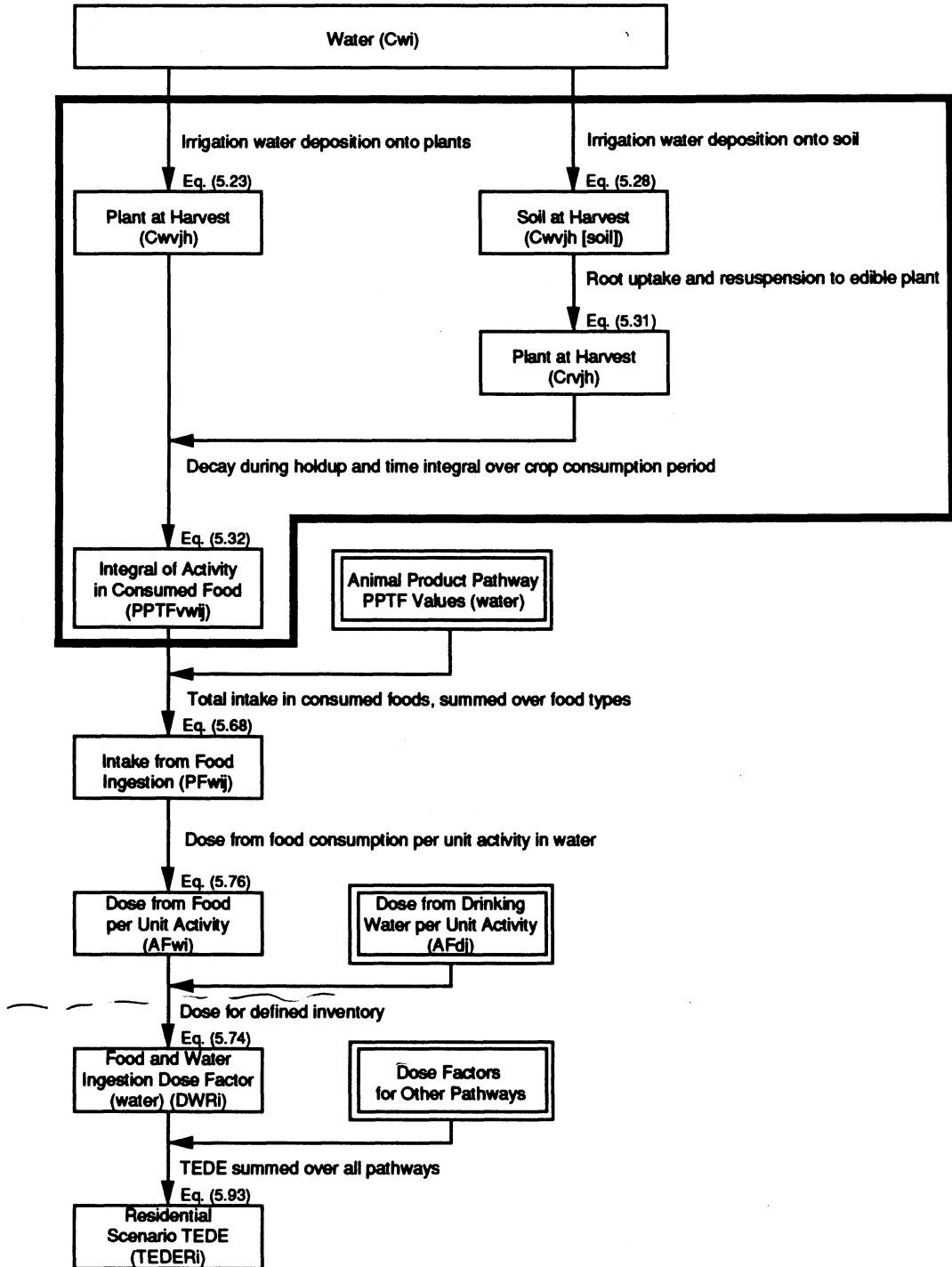

Figure 5.11 Water-plant-human pathway and water-soil-plant-human pathway

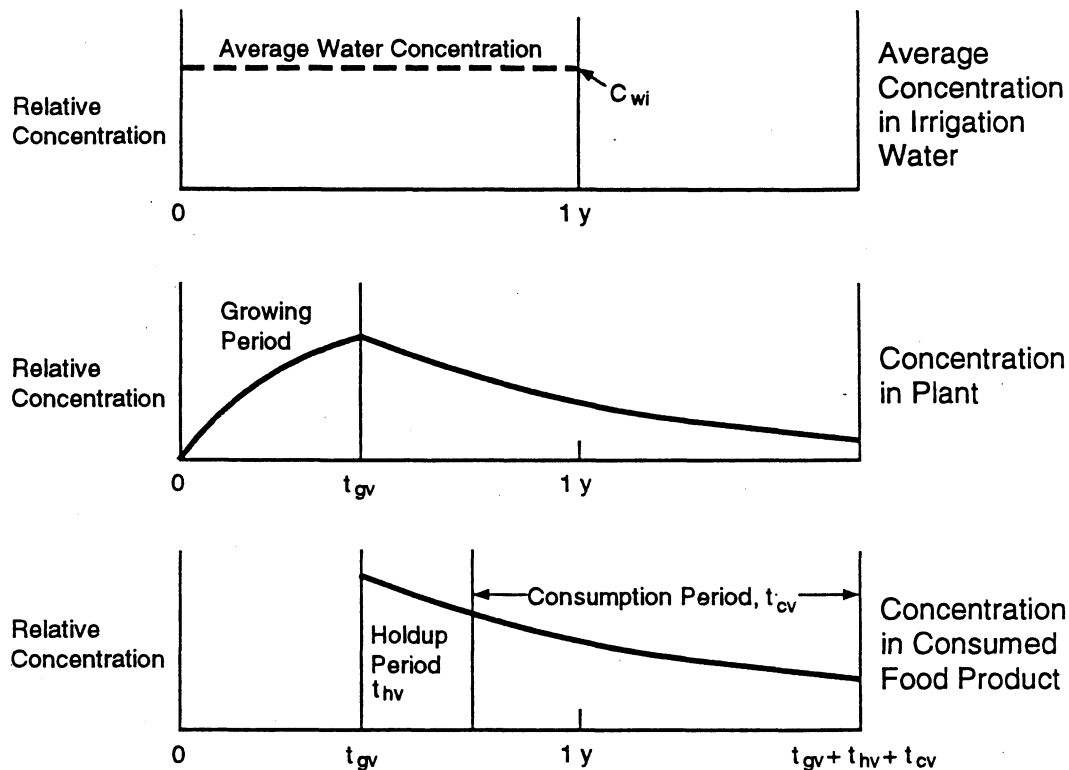

Figure 5.12 Changes in relative concentrations over time for irrigation water, plants, and human food from deposition of irrigation water onto plant surfaces

before the crop is consumed. During the consumption period, t_{cv} , the concentration continues to change. The PPTF for the year is evaluated as the time integral of the radionuclide concentrations in the food crop over the consumption period.

The change in radionuclide concentration in plants from irrigation deposition is described by the following general differential equation for each chain member:

$$\frac{dC_{wvjt}}{dt} = R_{wv jg} + \sum_{n=1}^{j-1} d_{nj} \lambda_{rj} C_{wvnt} - (\lambda_{rj} + \lambda_w) C_{wvjt} \tag{5.21}$$

where C_{wvjt} = concentration of radionuclide j in plant type v at time t during the growing period from application of irrigation water per unit average concentration of parent radionuclide i in water (pCi/kg wet-weight plant per pCi/L water)

C_{wvnt} = concentration of radionuclide n in plant type v at time t during the growing period from application of irrigation water per unit average concentration of parent radionuclide i in water (pCi/kg wet-weight plant per pCi/L water)

R_{wvjg} = average deposition rate of radionuclide j to edible parts of plant v from application of irrigation water per unit average concentration of parent radionuclide i in water (pCi/d • kg wet-weight plant per pCi/L water)

d_{nj} = decay branching fraction for transitions of radionuclide n to radionuclide j (dimensionless)

λ_{rj} = decay rate constant for radionuclide j (d^{-1})

λ_w = rate constant for loss of activity from plant surfaces due to weathering (d^{-1}).

The constant average rate of deposition of radionuclide j to plants is evaluated as follows:

$$R_{wvjg} = IR \ r_v \ T_v / Y_v \left[C_{wj} / C_{wi} \right] \quad (5.22)$$

where R_{wvjg} = average deposition rate of radionuclide j to edible parts of plant v from application of irrigation water per unit average concentration of parent radionuclide i in water (pCi/d • kg wet-weight plant per pCi/L water)

C_{wi} = average annual concentration of parent radionuclide i in irrigation water over the current annual period (pCi/L water)

C_{wj} = average annual concentration of radionuclide j in irrigation water over the current annual period (pCi/L water)

IR = average annual application rate of irrigation water ($L/m^2 \cdot d$)

r_v = fraction of initial deposition (in water) retained on the plant (pCi retained per pCi deposited)

T_v = translocation factor for transfer of radionuclides from plant surfaces to edible parts of the plant (pCi in edible plant part per pCi retained)

Y_v = yield of plant v (kg wet-weight plant/ m^2).

The deposition rate to plants, R_{wvjg} , is constant over the irrigation period because the concentration in water is constant (at the average value for C_{wj}). The evaluation of agricultural pathways is performed for 1 year of irrigation practice, normalized to initial unit concentration of the parent radionuclide in the irrigation water. All progeny are assumed to have zero concentration in water (i.e., $C_{wj} = 0.0$, $j \neq i$). The contributions from the progeny radionuclides are included in PPTF values calculated for each progeny as a parent of a decay chain. This convention is described in Section 5.2. With use of this convention, the PPTF values can be applied to any year of irrigation, as indicated in Sections 5.5 and 5.6.4. The ratio of radionuclide concentrations in water is included to indicate the source of activity units (pCi) and to provide consistency with other equations for radionuclide transfer to plants (e.g., Equation [5.5]).

The concentration factor for each radionuclide in edible parts of plants at the time of harvest is evaluated as the solution to Equation (5.21). The concentration factors can be written as follows using the deposition, accumulation with removal operator notation:

Residential

$$C_{wvjh} = R_e \{ R_{wvjg}, t_{gv} \} \quad (5.23)$$

where C_{wvjh} = concentration factor for radionuclide j in plant v at harvest from deposition onto plant surfaces for an average unit concentration of parent radionuclide i in water (pCi/kg wet-weight plant per pCi/L water)

t_{gv} = growing period for plant v (d)

$R_e \{ R_{wvjg}, t_{gv} \}$ = deposition, accumulation operator used to develop the concentration factor for radionuclide j in plant v at harvest from deposition onto plant surfaces for an average unit concentration of parent radionuclide i in water (pCi/kg wet-weight plant per pCi/L water).

Equation (5.23) applies to all members of the decay chain including the parent.

The deposition, accumulation operator notation can be expanded using equations of Section B.1 and B.4 to give the explicit equations for the parent and progeny radionuclide concentrations in the plant at harvest. The equations are as follows:

for the parent,

$$C_{ww1h} = R_{ww1g} \left[\frac{1 - e^{-\lambda_{e1} t_{gv}}}{\lambda_{e1}} \right] \quad (5.24)$$

and for the first progeny ($j=2$),

$$C_{ww2h} = \left[\frac{d_{12} \lambda_{r2} R_{ww1g}}{(\lambda_{e2} - \lambda_{e1})} \left(\frac{1 - e^{-\lambda_{e1} t_{gv}}}{\lambda_{e1}} \right) + \left(R_{ww2g} - \frac{d_{12} \lambda_{r2} R_{ww1g}}{\lambda_{e2} - \lambda_{e1}} \right) \left(\frac{1 - e^{-\lambda_{e2} t_{gv}}}{\lambda_{e2}} \right) \right] \quad (5.25)$$

where C_{ww1h} = concentration factor for parent radionuclide in plant v at harvest from deposition onto plant surfaces for an average unit concentration of parent in water ($i=j=1$), (pCi/kg wet-weight plant per pCi/L water)

C_{ww2h} = concentration factor for the first progeny radionuclide ($j=2$) in plant v at harvest from deposition onto plant surfaces for an average unit concentration of parent in water, (pCi/kg wet-weight plant per pCi/L water)

λ_{e1} = effective weathering and decay constant for the parent radionuclide ($j=1$) evaluated as the sum of the weathering rate constant, λ_w , and the radioactive decay constant, λ_{r2} (d^{-1})

λ_{e2} = effective weathering and decay constant for radionuclide 2 (second chain member) evaluated as the sum of the weathering rate constant, λ_w , and the radioactive decay constant, λ_{r2} (d^{-1})

and other terms are as previously defined for parent radionuclide (subscript 1) and first progeny (subscript 2) radionuclide.

5.4.1.2 Irrigation Water-Soil-Plant-Human Pathway

Figure 5.13 illustrates the variation with time of the relative parent radionuclide concentration in irrigation water, growing plants, and consumed plants for the water-soil-plant-human pathway. For this pathway, the concentration in plants results from resuspension and root uptake of radionuclides in irrigation water applied to the soil. As before, the radionuclide concentration in water is constant over the year of exposure. Radionuclides that enter the soil via irrigation water accumulate with time and are assumed to be contained in the top 15-cm soil layer. This activity will consequently be available for root uptake. The radionuclide concentration in plants is assumed to be in constant equilibrium with the radionuclide concentration in soil. The radionuclide concentration in plants at harvest will change during the holdup period before the plant is consumed by humans. The total radionuclide intake during the

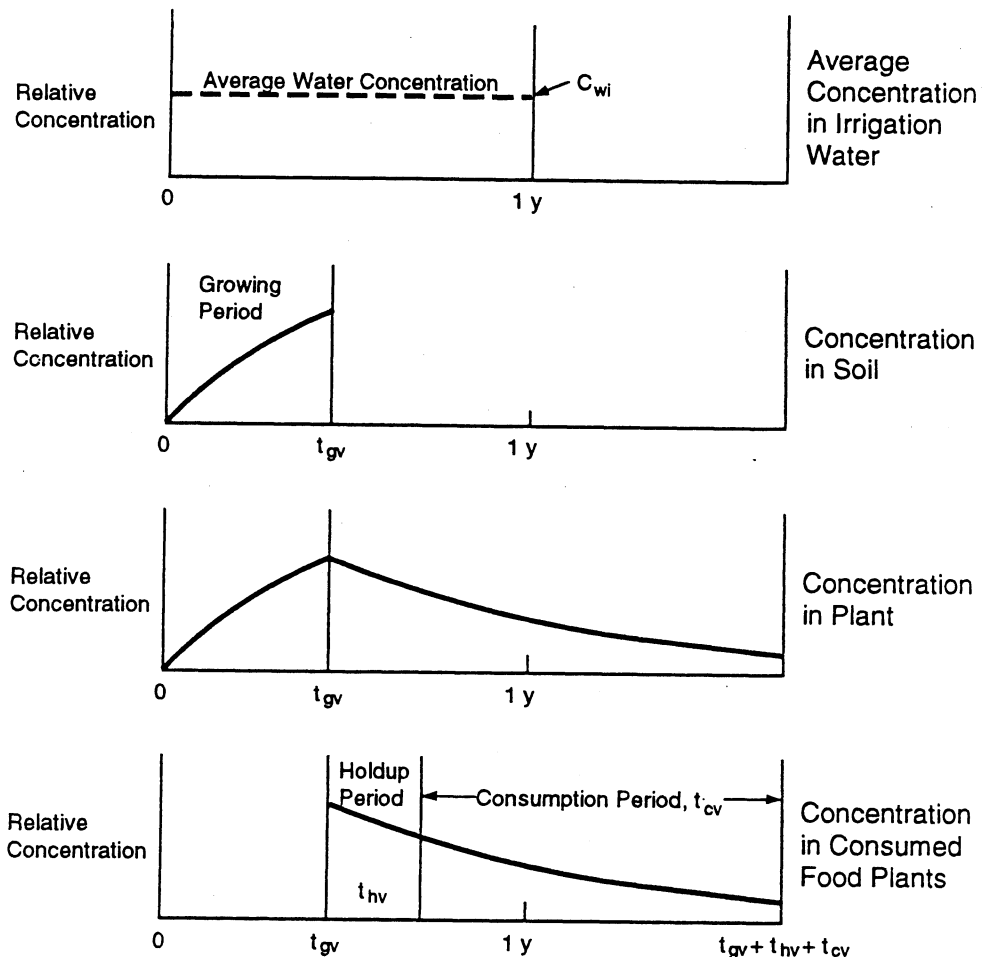

Figure 5.13 Change in relative concentrations over time for irrigation water, soil, plants, and human foods from deposition of irrigation water on soil with subsequent root uptake

consumption period is evaluated as the time integral of concentration in the plant over the consumption period, starting with the plant concentration at the beginning of the period (after decay during holdup).

The transfer is modeled in a manner analogous to that for deposition directly onto plants, as described in Section 5.4.1.1. The concentration in soil at the end of the growing period is evaluated as the solution to the following differential equation for concentration of a radionuclide in soil. Because the concentration of radionuclides in plants is assumed to be continuously in equilibrium with the concentration in soil, the concentration in crops at the end of the growing season is proportional to the soil concentration at the end of the growing season.

The change in radionuclide concentration in soil from irrigation deposition is described by the following general differential equation for each chain member:

$$\frac{d C_{wsjt}}{dt} = R_{wsjg} + \sum_{n=1}^{j-1} d_{nj} \lambda_{rj} C_{wsnt} - \lambda_{rj} C_{wsjt} \quad (5.26)$$

where C_{wsjt} = concentration of radionuclide j in soil at time t during the growing period for an average unit concentration of parent radionuclide i in water (pCi/kg dry-weight soil per pCi/L water)

C_{wsnt} = concentration of radionuclide n in soil at time t during the growing period for an average unit concentration of parent radionuclide i in water (pCi/kg dry-weight soil per pCi/L water)

R_{wsjg} = average deposition rate of radionuclide j to soil from application of irrigation water onto soil during the growing period for an average unit concentration of parent radionuclide i in water (pCi/d • kg dry-weight soil per pCi/L water)

and other terms are as previously defined.

The average deposition rate of radionuclide j to soil is evaluated as follows:

$$R_{wsjg} = IR / P_s \left[C_{wj} / C_{wi} \right] \quad (5.27)$$

where R_{wsjg} = average deposition rate of radionuclide j to soil from irrigation water application onto soil during the growing period for an average unit concentration of parent radionuclide i in water (pCi/d • kg dry-weight soil per pCi/L water)

C_{wj} = average concentration of radionuclide j in irrigation water over the current annual period (pCi/L water)

C_{wi} = average concentration of parent radionuclide i in irrigation water over the current annual period (pCi/L water)

IR = annual average application rate of irrigation water (L/m²•d)

P_s = areal soil density (kg dry weight soil/m²).

The contribution from irrigation to radionuclide concentration in soil at the time of harvest of plant v is evaluated as follows using the deposition, accumulation operator notation:

$$C_{wvjh(\text{soil})} = R\{R_{wsjg}, t_{gv}\} \quad (5.28)$$

where $C_{wvjh(\text{soil})}$ = concentration factor for radionuclide j in soil at harvest time for plant v for an average unit concentration of parent radionuclide i in water (pCi/kg dry-weight soil per pCi/L water)

$R\{R_{wsjg}, t_{gv}\}$ = deposition, accumulation operator used to develop the concentration factor for radionuclide j in soil at the time of harvest of plant v for an average unit concentration of parent radionuclide i in water (pCi/kg dry-weight soil per pCi/L water)

and other terms are as previously defined.

Equation (5.28) can be expanded using operator notation defined in Section B.1 and B.4 to give an explicit equation for the parent and first progeny radionuclide concentration factors in soil at the end of the plant-growing season. The equations are as follows:

for the parent,

$$C_{wv1h(\text{soil})} = R_{ws1g} \left[\frac{1 - e^{-\lambda_{r1} t_{gv}}}{\lambda_{r1}} \right] \quad (5.29)$$

and for the progeny ($j=2$),

$$C_{wv2h(\text{soil})} = \left[\frac{d_{12} \lambda_{r2} R_{ws1g} \left(\frac{1 - e^{-\lambda_{r1} t_{gv}}}{\lambda_{r1}} \right)}{(\lambda_{r2} - \lambda_{r1})} \right] + \left[R_{ws2g} - \frac{d_{12} \lambda_{r2} R_{ws1g}}{\lambda_{r2} - \lambda_{r1}} \right] \left[\frac{1 - e^{-\lambda_{r2} t_{gv}}}{\lambda_{r2}} \right] \quad (5.30)$$

where terms are as previously defined for parent radionuclide (subscript 1) and first progeny radionuclide (subscript 2).

The concentration of radionuclides in edible portions of plants at the time of harvest is evaluated from the concentration of radionuclides in soil at the time of harvest. The evaluation is made using the soil-to-plant concentration factor as follows:

$$C_{rvjh} = (ML_v + B_{jv}) W_v C_{wvjh(\text{soil})} \quad (5.31)$$

where C_{rvjh} = concentration factor for radionuclide j in plant v at time of harvest resulting from resuspension and root uptake for an average unit concentration of parent radionuclide i in water (pCi/kg wet-weight plant per pCi/L water)

B_{jv} = concentration factor for uptake of radionuclide j from soil in plant v (pCi/kg dry-weight plant per pCi/kg dry-weight soil)

ML_v = plant soil mass-loading factor for resuspension of soil to edible plant parts for plant v (pCi/kg dry-weight plant per pCi/kg dry-weight soil)

W_v = factor for conversion of mass of plant v from a dry-weight to a wet-weight basis (kg dry-weight plant per kg wet-weight plant)

and other terms are as previously defined. Equations (5.28) and (5.31) apply to all members of the decay chain including the parent.

5.4.1.3 Calculation of PPTFs for Food Crops Contaminated by Irrigation Water

The PPTFs for food crops are calculated starting with the radionuclide concentration in plants at harvest, as evaluated using Equations (5.23) and (5.31). The harvest concentration first undergoes decay for a holdup time before initial consumption by humans. The total intake by humans is then evaluated as the time integral of the radionuclide concentration in food crops during the consumption period, t_{cv} . As a conservative assumption, removal of radionuclides by washing during food preparation is not considered. The contributions from each pathway (direct deposition of irrigation water onto plants and deposition onto soil with resuspension and root uptake) are summed to give a total PPTF:

$$PPTF_{vwij} = \left[S \left\{ A \left\{ C_{wvjh}, t_{hv} \right\}, t_{cv} \right\} + S \left\{ A \left\{ C_{rvjh}, t_{hv} \right\}, t_{cv} \right\} \right] / 365.25 \quad (5.32)$$

where $PPTF_{vwij}$ = partial pathway transfer factor for the irrigation pathway for plant v, for radionuclide j as a progeny of radionuclide i for an average unit concentration of parent radionuclide i in water (pCi•y/kg wet-weight plant per pCi/L in water for a year of residential scenario)

$A\{C_{wvjh}, t_{hv}\}$ = decay operator notation used to develop the concentration factor for radionuclide j in plant v (as a result of deposition onto plants) at time of human consumption after holdup (t_{hv}) for an average unit concentration of parent radionuclide i in water (pCi/kg wet-weight plant per pCi/L water)

$A\{C_{rvjh}, t_{hv}\}$ = decay operator notation used to develop the concentration factor for radionuclide j in plant v (as a result of root uptake) at time of human consumption after holdup (t_{hv}) for an average unit concentration of parent radionuclide i in water (pCi/kg wet-weight plant per pCi/L water)

$S\{A\}, t_{cv}\}$ = time-integral operator notation used to develop the concentration time-integral factor for radionuclide j over the consumption period of plant v for the irrigation water pathway for an average unit concentration of parent radionuclide i in water (pCi•d/kg wet-weight plant per pCi/L water for a year of residential scenario)

t_{cv} = consumption period of plant v by humans (d for 1 y of residential scenario)

t_{hv} = holdup time between harvest and consumption of plant v (d)

365.25 = unit conversion factor (d/y).

The decay operator notation in Equation (5.32) can be expanded for specific radionuclides in the decay chain using the formulas of Appendix B for radioactive chain decay. As an illustration of this expansion for nested operators, consider the second term on the right side of Equation (5.32) for food crops contaminated by the root uptake and resuspension

pathways. The starting point in the evaluation is the activity of each chain member in the plant at the time of harvest, given by the parameter C_{rvjh} of Equation (5.31). The concentration of the parent after decay during the holdup period can be expressed as follows:

$$C_{rv1p}(t_{hv}) = C_{rv1h}(t_{gv}) e^{-\lambda_{r1}t_{hv}} \quad (5.33)$$

where $C_{rv1p}(t_{hv})$ is the concentration factor for the parent radionuclide in plant v at the start of the consumption period (pCi/kg wet-weight plant per pCi/L water) and other terms are as previously defined. The activity of the first progeny radionuclide ($j=2$) in the plant at the start of consumption is given by the following expression:

$$C_{rv2p}(t_{hv}) = \frac{d_{12} \lambda_{r2} C_{rv1h}(t_{gv})}{\lambda_{r2} - \lambda_{r1}} e^{-\lambda_{r1}t_{hv}} + \left[C_{rv2h}(t_{gv}) - \frac{d_{12} \lambda_{r2} C_{rv1h}(t_{gv})}{\lambda_{r2} - \lambda_{r1}} \right] e^{-\lambda_{r2}t_{hv}} \quad (5.34)$$

where $C_{rv1h}(t_{gv})$ and $C_{rv2h}(t_{gv})$ represent the initial concentrations of the parent and first progeny radionuclide in plant v at the start of the decay period (holdup period), and $C_{rv2p}(t_{hv})$ represents the concentrations after decay for the holdup period. The integral evaluation, indicated by the time-integral operator $S\{\}$, is applied to the results of Equations (5.33) and (5.34). The expression can be written as follows for the parent radionuclide:

$$\int_{t_{hv}}^{t_{hv} + t_{cv}} C_{rv1p}(t) dt = C_{rv1p}(t_{hv}) \left[\frac{1 - e^{-\lambda_{r1}t_{cv}}}{\lambda_{r1}} \right] \quad (5.35)$$

where the result is the time integral of the concentration factor for parent radionuclide i in plant v over the consumption period (pCi·d/kg wet-weight plant per pCi/L water) and other terms are as previously defined. The time integral for the first progeny radionuclide ($j=2$) in the plant over the consumption period is given by the following expression:

$$\int_{t_{hv}}^{t_{hv} + t_{cv}} C_{rv2p}(t) dt = \frac{d_{12} \lambda_{r2} C_{rv1p}(t_{hv})}{\lambda_{r2} - \lambda_{r1}} \left[\frac{1 - e^{-\lambda_{r1}t_{cv}}}{\lambda_{r1}} \right] + \left[C_{rv2p}(t_{hv}) - \frac{d_{12} \lambda_{r2} C_{rv1p}(t_{hv})}{\lambda_{r2} - \lambda_{r1}} \right] \cdot \left[\frac{1 - e^{-\lambda_{r2}t_{cv}}}{\lambda_{r2}} \right] \quad (5.36)$$

where the result represents the concentration time integral of the first progeny radionuclide in plant v over the consumption period and other terms are as previously defined with subscripts 1 and 2 for parent and first progeny, respectively.

5.4.2 Animal Products Contaminated by Irrigation Water

This section discusses seven pathways involving the consumption of animal products by humans, each beginning with irrigation water as the source of radionuclides; three involve irrigation water directly applied to animal feed (stored hay, stored grain, and fresh forage) and three involve irrigation water applied to soil and thence to plants (evaluated

again for stored hay, stored grain, and fresh forage feed). The seventh pathway involves animals drinking the irrigation water. An overview of the modeling processes included in the water-plant-animal-human pathway and the water-soil-plant-animal-human pathway is shown in Figure 5.14. The bold box in this figure relates to the double-lined box in master Figure 5.3, showing the overall modeling details for the residential scenario. As shown in Figure 5.14, four significant processes, and numerous subprocesses, are accounted for in this pathway: 1) calculation of the deposition of radionuclides onto plants used to feed animals and soil with calculation of the concentration at the time of feeding or harvest, 2) calculation of the concentration in plants at the time of harvest, accounting for root uptake and for radioactive decay during holdup, 3) calculation of the concentration in animal products from animal ingestion of forage, stored hay, stored grain, and water, and 4) calculation of the time integral of activity for human ingestion of animal products over the consumption period (calculation of the PPTF for these pathways). Equation numbers are included in Figure 5.14 to help identify the specific mathematical formulations used in the models. Figure 5.14 also shows linkages to the other significant processes needed to estimate the annual TEDE for the residential scenario. The double-lined boxes in Figure 5.14 show linkages to the other pathways considered in the residential scenario.

The assumptions for evaluation of these pathways are as follows:

- The concentration of radionuclides in irrigation water (and animal drinking water) is constant over the year of irrigation (i.e., an average water concentration is used).
- Material deposited onto plant surfaces is removed at a constant weathering half-time.
- Radionuclide concentrations in soils are continuously in equilibrium with radionuclide concentrations in edible portions of the plants grown in the soil.
- Animals take in soil while grazing. The intake amount is a constant fraction of the forage intake rate, Q_f .
- Stored feeds are used for animal feed as soon as they are harvested. Feeding continues after harvest during the stored-feed feeding period.
- The concentration in animal products is immediately in equilibrium with the concentration in intake (feed, water, and soil).
- Animal products are harvested (e.g., milked, slaughtered, or eggs gathered) continuously over the feeding period and then distributed for human consumption.
- The harvested animal products are held for a short time before being consumed by humans.

Animal products may be contaminated when the animal eats crops (forage or stored feeds) produced using contaminated irrigation water. Each of these crop types may be contaminated by direct deposition of water onto leaves, or from deposition onto soil with uptake via roots and resuspension. These routes of animal feed contamination are described below.

5.4.2.1 Irrigation Water-Forage-Animal-Human Pathway

Figure 5.15 illustrates the variation with time of the relative parent radionuclide concentration in irrigation water, forage plants, animal products, and consumed plants for the water-forage plant-animal-human pathway. As before, the

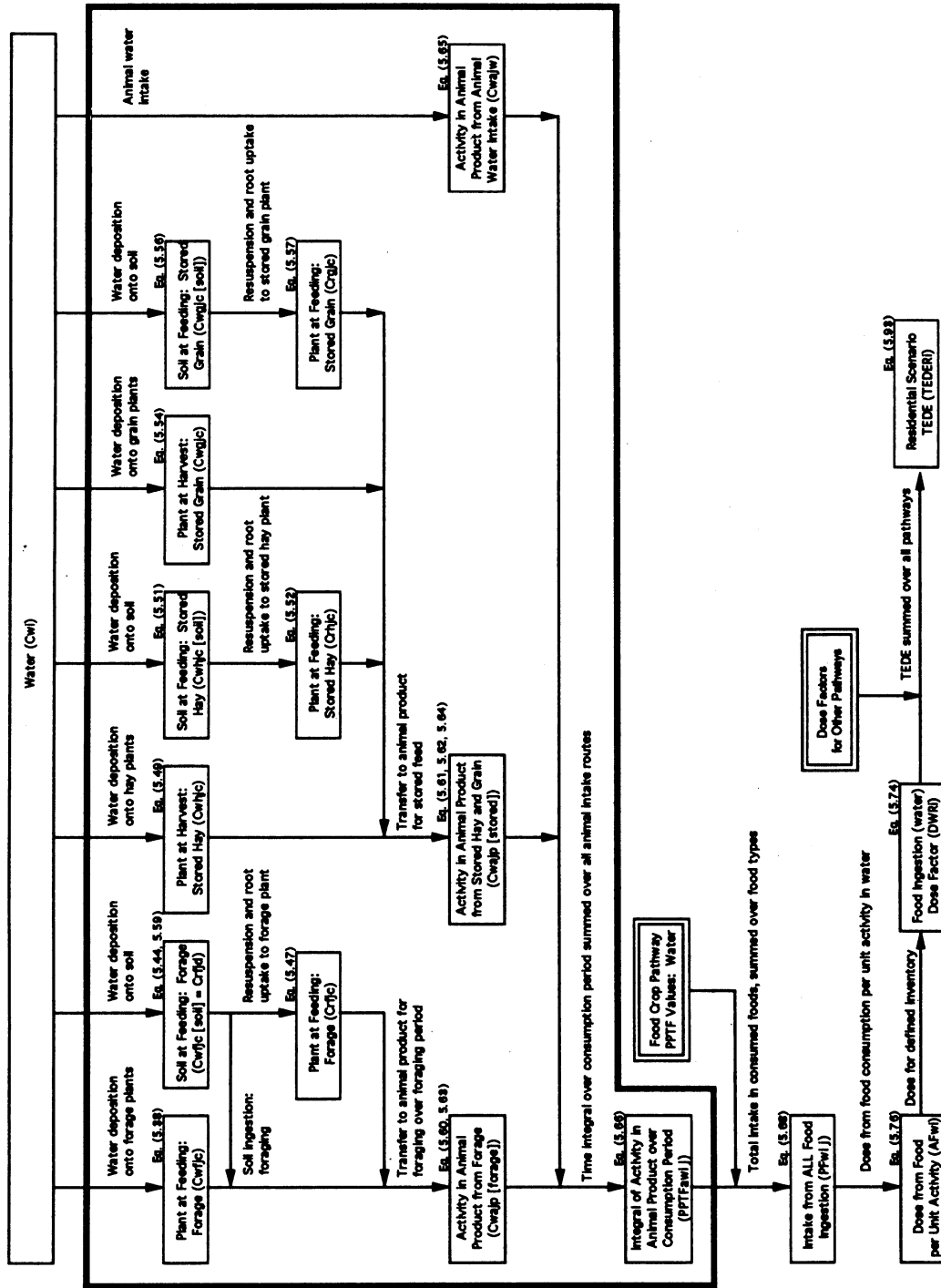

Figure 5.14 Water-plant-animal-human pathway and water-soil-plant-animal-human pathway

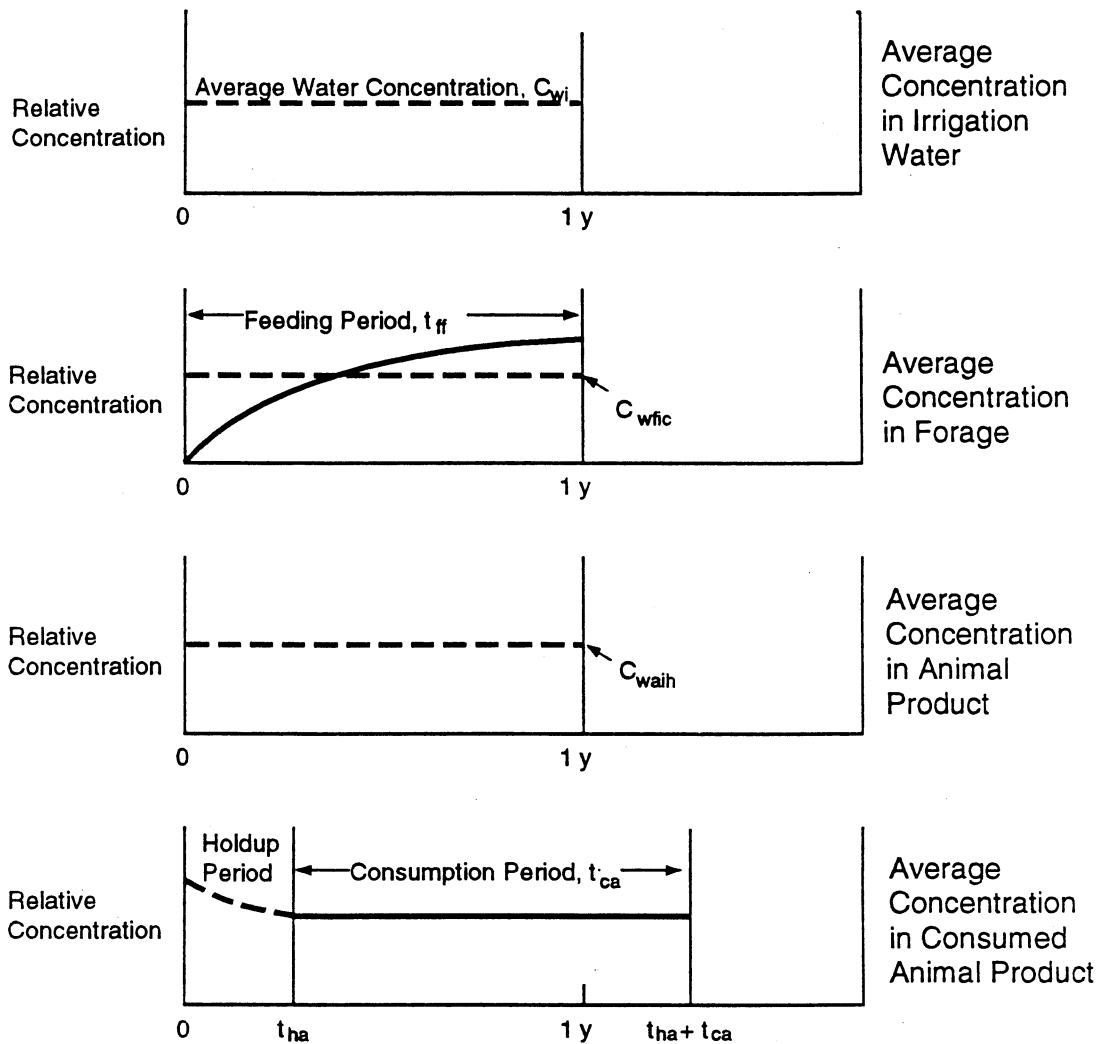

Figure 5.15 Change in relative concentrations over time for irrigation water, forage, animal products, and human foods from deposition of irrigation water on animal forage

water concentration is constant over the year of exposure. The differential equation defining the radionuclide concentration in forage plants is the same as Equation (5.21) for food crops. The constant deposition rate of radionuclide j to forage plants is evaluated according to Equation (5.22) with parameters defined for the forage crop:

$$R_{wffj} = IR \ I_f \ T_f / Y_f \ [C_{wj} / C_{wi}] \quad (5.37)$$

where R_{wffj} = average deposition rate of parent radionuclide j to forage crop f from application of irrigation water during the feeding period for an average unit concentration of parent radionuclide i in water (pCi/d • kg wet-weight plant per pCi/L water)

C_{wi} = average annual concentration of parent radionuclide i in irrigation water over the current annual period (pCi/L water)

C_{wj} = average annual concentration of radionuclide j in irrigation water over the current annual period (pCi/L water)

IR = annual average application rate of irrigation water ($L/m^2 \cdot d$)

r_f = fraction of initial deposition of radionuclides in water retained on the plant (pCi retained per pCi deposited)

T_f = translocation factor for transfer of radionuclides from plant surfaces to edible parts of the plant (pCi in edible plant part per pCi retained)

Y_f = yield of forage crop f (kg wet-weight plant/ m^2).

The concentration of radionuclides in forage feed is evaluated as an average over the consumption period because the animals are assumed to graze continuously over the consumption period. The evaluation of the average radionuclide concentration in forage involves integrating the concentration in the plants over the time period, and then dividing the result by the feeding period. This average value is then used to estimate the concentration of radionuclides in the animal product. Evaluating the radionuclide concentration in plants involves the solution to Equation (5.21) for deposition, accumulation, and time integration of the resulting plant concentration, C_{wfjc} . The general solution is indicated in operator notation as follows:

$$C_{wfjc} = G_e \{R_{wfjf}, t_{ff}\} / t_{ff} \quad (5.38)$$

where C_{wfjc} = average concentration factor for radionuclide j in forage crop f at time of animal consumption from direct deposition onto plant surfaces for an average unit concentration of parent radionuclide i in water (pCi/kg wet-weight plant per pCi/L water)

t_{ff} = period of feeding of forage crop f (d)

$G_e \{R_{wfjf}, t_{ff}\}$ = operator notation used to develop the deposition, accumulation, and time integration of the concentration of radionuclide j in forage crop f over the animal forage consumption period for an average unit concentration of parent radionuclide i in water (pCi/kg wet-weight plant per pCi/L water)

and other terms are as previously defined. The operator $G_e \{ \}$ represents the deposition, accumulation, and time integration of the concentration over the forage-feeding period with continuous deposition and weathering.

For parent and first progeny radionuclides, the concentrations in forage plants from direct deposition onto plant surfaces are represented by the following two equations:

for the parent radionuclide,

$$C_{wf1c} = R_{wf1f} \left\{ t_{ff} - \left[1 - e^{-\lambda_{e1} t_{ff}} \right] / (\lambda_{e1}) \right\} / (t_{ff} \lambda_{e1}) \quad (5.39)$$

and for decay-chain-member radionuclides, noting that the average concentration and deposition rate for the progeny in irrigation water are zero,

$$C_{wf2c} = \frac{d_{12} \lambda_{r2} R_{wf1f}}{\lambda_{r2} - \lambda_{r1}} \left[t_{ff} - \frac{1 - e^{-\lambda_{e1} t_{ff}}}{\lambda_{e1}} \right] / (\lambda_{e1} t_{ff})$$

$$- \frac{d_{12} \lambda_{r2} R_{wf1f}}{\lambda_{r2} - \lambda_{r1}} \left[t_{ff} - \frac{1 - e^{-\lambda_{e2} t_{ff}}}{\lambda_{e2}} \right] / (\lambda_{e2} t_{ff})$$
(5.40)

where the terms are as previously defined with subscripts 1 and 2 referring to the parent and first progeny in the decay chain, respectively.

As described above and in Section B.5, the deposition, accumulation and time-integral operator, $G_e \{ \}$, involves two steps: solution of the differential equation for plant concentration, Equation (5.21), followed by a time integration over the period of interest. The solution to the differential equation is equivalent to the deposition-accumulation operator, $R_e \{ \}$, for accumulation with removal. The solution can be written for a parent radionuclide for any time t as follows:

$$C_{wf1t} = R_{wf1f} \left[\frac{1 - e^{-\lambda_{e1} t}}{\lambda_{e1}} \right]$$
(5.41)

where C_{wf1t} = concentration factor for the parent radionuclide in forage crop f at any time t after beginning of irrigation deposition for an average unit concentration of parent radionuclide in water (pCi/kg wet-weight plant per pCi/L water)

and other terms are as previously defined. The average concentration factor is evaluated as the time integral of plant concentration divided by the forage-crop feeding period. This calculation can be represented in operator notation as follows:

$$C_{wfjc} = \frac{1}{t_{ff}} \int_{t_{ff}^o}^{t_{ff}} R_e \{ R_{wfjf}, t \} dt = \frac{1}{t_{ff}} G_e \{ R_{wfjf}, t_{ff} \}$$
(5.42)

where terms are as previously defined. Evaluation of this equation for the parent and first progeny is shown above in Equation (5.39) and (5.40).

5.4.2.2 Irrigation Water-Soil-Forage-Animal-Human Pathway

Figure 5.16 illustrates the time variation of the relative parent radionuclide concentration in water, soil, forage plants, animal products, and food eaten by humans for the water-soil-forage-animal-human pathway. Radionuclides that enter the soil via irrigation water are assumed to be contained in the top 15-cm soil layer (i.e., the top box of the three-box water-use model described in Section 5.6.6 and Appendix B). This activity will be available for immediate root uptake and resuspension to forage plants. The differential equation describing the change in radionuclide concentration in soil from irrigation deposition is given by Equation (5.26). The average deposition rate to soil is evaluated as follows (as in Equation [5.27]):

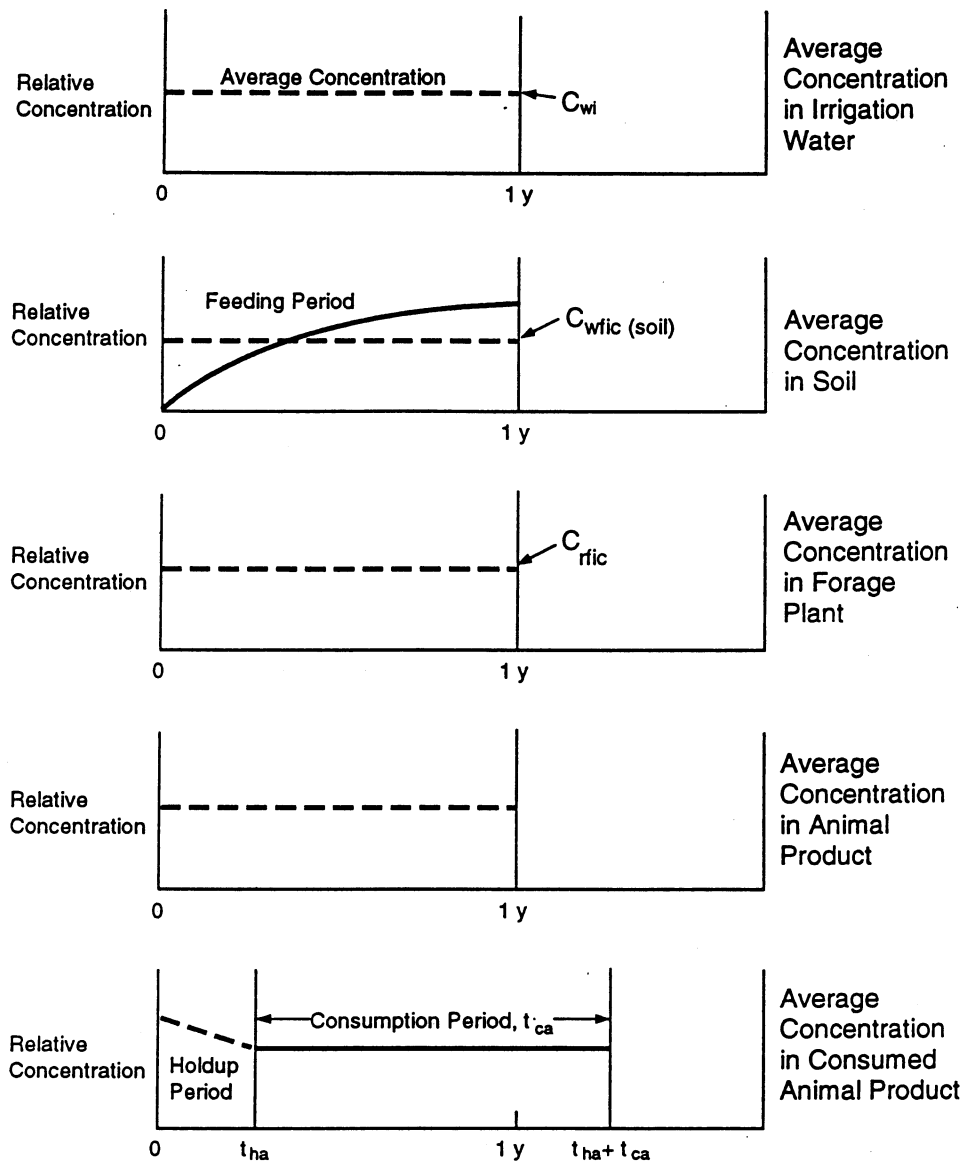

Figure 5.16 Change in relative concentrations over time for irrigation water, soil, forage, animal products, and human foods from deposition of irrigation water on soil with subsequent resuspension and root uptake to forage plants

$$R_{wsjf} = IR / P_s \left[C_{wj} / C_{wi} \right] \quad (5.43)$$

where R_{wsjf} = average deposition rate of radionuclide j to soil from irrigation water application onto the soil during the feeding period for an average unit concentration of parent radionuclide i in water (pCi/d • kg dry-weight soil per pCi/L water)

C_{wi} = average concentration of parent radionuclide i in irrigation water over the current annual period (pCi/L water)

C_{wj} = average concentration of radionuclide j in irrigation water over the current annual period (pCi/L water)

IR = annual average application rate of irrigation water (L/m²•d)

P_s = areal soil density (kg dry-weight soil/m²).

The radionuclide concentration in forage plants (averaged over the animal feeding period) from irrigation-water deposition and uptake from soil by forage plants is evaluated from the average soil concentration. The general equation using the deposition, accumulation, and time integration notation is

$$C_{wfjc(\text{soil})} = G \left\{ R_{wsjf}, t_{ff} \right\} / t_{ff} \quad (5.44)$$

where $C_{wfjc(\text{soil})}$ = average concentration factor for radionuclide j in soil at time of animal consumption of forage crop f for an average unit concentration of parent radionuclide i in water (pCi/kg dry-weight soil per pCi/L water)

$G \{ R_{wsjf}, t_{ff} \}$ = operator notation used to develop the deposition, accumulation, and time integration of the concentration of radionuclide j in soil over the animal consumption period of forage crop f for an average concentration of parent radionuclide i in water (pCi/kg dry-weight soil per pCi/L water)

and other terms are as previously defined.

Explicit equations can be written for the parent radionuclide as follows:

$$C_{wf1c(\text{soil})} = R_{ws1f} \left\{ t_{ff} - \left[1 - e^{-\lambda_{r1} t_{ff}} \right] / \lambda_{r1} \right\} / (\lambda_{r1} t_{ff}) \quad (5.45)$$

and for the first progeny radionuclides,

$$C_{wf2c(\text{soil})} = \frac{d_{12} \lambda_{r2} R_{ws1f}}{\lambda_{r2} - \lambda_{r1}} \left[t_{ff} - \frac{1 - e^{-\lambda_{r1} t_{ff}}}{\lambda_{r1}} \right] / (\lambda_{r1} t_{ff}) \\ - \frac{d_{12} \lambda_{r2} R_{ws1f}}{\lambda_{r2} - \lambda_{r1}} \left[t_{ff} - \frac{1 - e^{-\lambda_{r2} t_{ff}}}{\lambda_{r2}} \right] / (\lambda_{r2} t_{ff}) \quad (5.46)$$

where terms are as previously defined, with subscripts 1 and 2 referring to the parent and first progeny in the decay chain, respectively.

The average concentration of radionuclides in forage during the forage-feeding period is evaluated from the average concentration of radionuclides in soil over the feeding period. The evaluation is made using the forage plant concentration factor as follows:

$$C_{rfjc} = (ML_f + B_{jf}) W_f C_{wfjc}(\text{soil}) \quad (5.47)$$

where C_{rfjc} = average concentration factor for radionuclide j in forage crop f at time of forage feeding, resulting from resuspension and root uptake from soil for an average unit concentration of parent radionuclide i in water (pCi/kg wet-weight forage per pCi/L water)

B_{jf} = concentration factor for uptake of radionuclide j from soil in forage crop f (pCi/kg dry-weight forage per pCi/kg dry-weight soil)

ML_f = plant soil mass-loading factor for resuspension of soil to forage plant f (pCi/kg dry-weight forage per pCi/kg dry soil)

W_f = factor for conversion of mass of forage crop f from a dry-weight to a wet-weight basis (kg dry-weight forage per kg wet-weight forage)

and C_{wfjc} is as previously defined. Equation (5.47) applies to all members of the decay chain including the parent.

5.4.2.3 Irrigation Water-Stored Hay-Animal-Human Pathway

Figure 5.17 illustrates the time variation of relative parent radionuclide concentration in irrigation water, stored hay plants, animal products, and food eaten by humans for the water-stored hay-animal-human pathway. For this pathway, the radionuclide concentration in stored hay is derived from radionuclides in irrigation water deposited on stored hay plant surfaces. The concentration at stored hay harvest is evaluated for a constant deposition rate of radionuclides from irrigation water onto the hay crop. Loss by weathering from plant surfaces is considered. The stored hay is fed to the animal over a feeding period that begins immediately after harvest and continues for the feeding period. The differential equation describing the change in radionuclide concentration in stored hay plants from irrigation deposition is analogous to Equation (5.21). The average deposition rate of radionuclide j to stored hay plants is evaluated as follows (per Equation [5.22]):

$$R_{whjg} = IR r_h T_h / Y_h [C_{wj} / C_{wi}] \quad (5.48)$$

where R_{whjg} = average deposition rate of radionuclide j to stored hay crop h from irrigation water application for an average unit concentration of parent radionuclide i in water (pCi/d•kg wet-weight plant per pCi/L water)

C_{wi} = average concentration of parent radionuclide i in irrigation water over the current annual period (pCi/L water)

C_{wj} = average concentration of radionuclide j in irrigation water over the current annual period (pCi/L water)

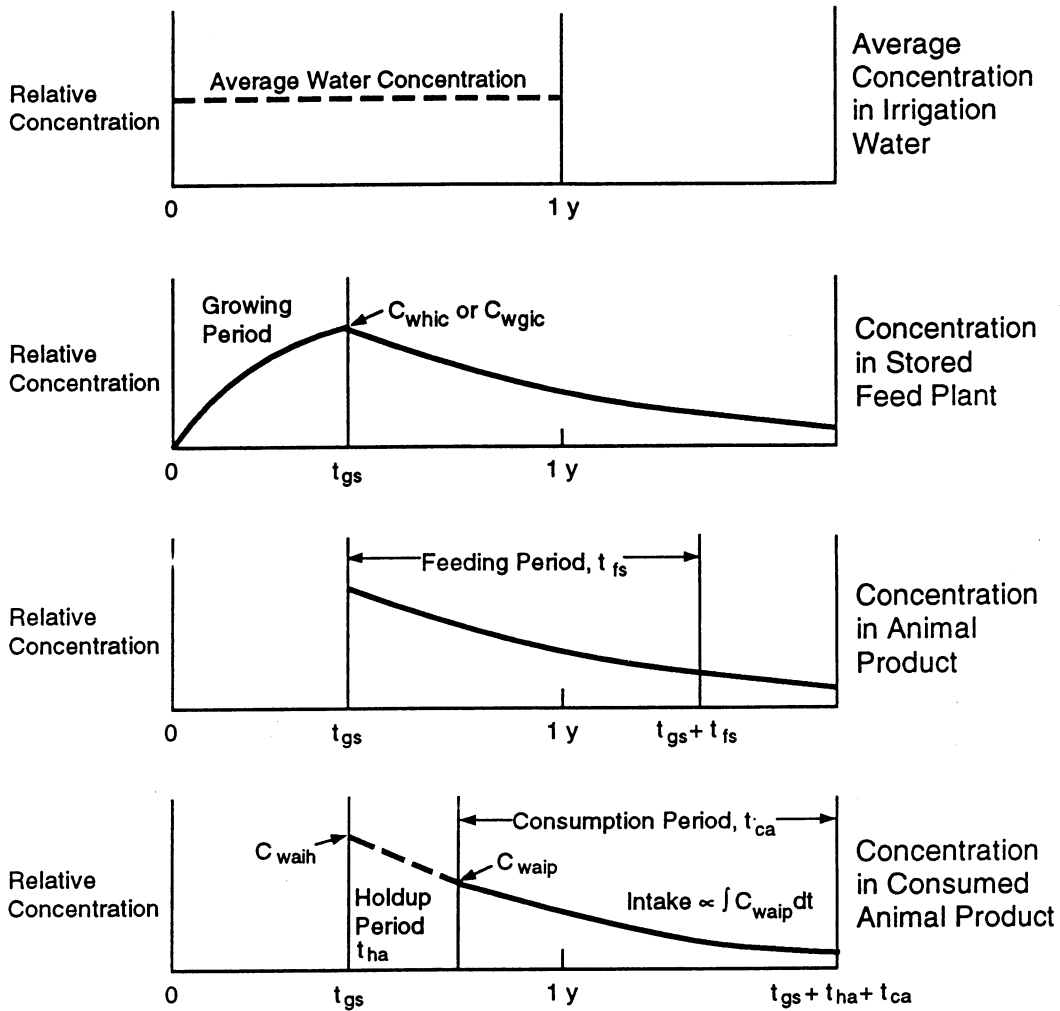

Figure 5.17 Change in relative concentrations over time for irrigation water, stored feed, animal products, and human food from deposition of irrigation water on stored feed plants

IR = annual average application rate of irrigation water ($L/m^2 \cdot d$)

r_h = fraction of initial deposition of radionuclides in water retained on plant h (pCi retained per pCi deposited)

T_h = translocation factor for transfer of radionuclides from plant surfaces to edible parts of the plant (pCi in edible plant parts per pCi retained)

Y_h = yield of stored hay crop h (kg wet-weight plant/ m^2).

The concentration of radionuclides in stored hay crops from deposition onto plant surfaces at the time of animal initial feeding is evaluated using Equation (5.23) with parameters defined for stored hay plants:

$$C_{whjc} = R_e \{R_{whjg}, t_{gh}\} \quad (5.49)$$

where C_{whjc} = concentration factor for radionuclide j in stored hay crop h at initial time of consumption by animal, from deposition onto plant surfaces for an average unit concentration of parent radionuclide i in water (pCi/kg wet-weight plant per pCi/L water)

t_{gh} = growing period of stored hay type h (d)

$R_e \{R_{whjg}, t_{gh}\}$ = deposition, accumulation operator notation used to develop the concentration factor for radionuclide j in stored hay crop h at the initial time of harvest, from irrigation water deposition onto plants for an average unit concentration of parent radionuclide i in water (pCi/kg wet-weight plant per pCi/L water)

and other terms are as previously defined. Explicit equations for the parent and first progeny have the same form as the example equations shown in Section 5.4.1.1 (Equations [5.24] and [5.25]). A detailed description of the operator notation is given in Section 2 and Appendix B.

5.4.2.4 Irrigation Water-Soil-Stored Hay-Animal-Human Pathway

As with the water-soil-food crop-human pathway, the deposition from irrigation water is assumed to transfer to soil with subsequent uptake via resuspension and through roots to plants. Figure 5.18 illustrates the time variation of relative parent radionuclide concentrations for this pathway. The differential equation describing the time rate of change of radionuclide concentrations in soil is given by Equation (5.26). The constant deposition rate for a radionuclide to soil is evaluated according to Equation (5.27) with parameters defined for stored hay plants. The deposition rate of radionuclides to soil is evaluated as follows:

$$R_{wsjg} = IR / P_s [C_{wj} / C_{wi}] \quad (5.50)$$

where R_{wsjg} = average deposition rate of radionuclide j to soil from irrigation water application onto the soil during the crop-growing period for stored hay for an average unit concentration of parent radionuclide i in water (pCi/d • kg dry-weight soil per pCi/L water)

C_{wi} = average concentration of parent radionuclide i in irrigation water over the current annual period (pCi/L water)

C_{wj} = average concentration of radionuclide j in irrigation water over the current annual period (pCi/L water)

IR = annual average application rate of irrigation water (L/m²•d)

P_s = areal soil density (kg dry-weight soil/m²).

The concentration of radionuclides in soil at the time of stored hay crop harvest (beginning of feed consumption by animals) is evaluated as the solution to Equation (5.26) with the deposition rate defined by Equation (5.50) as follows:

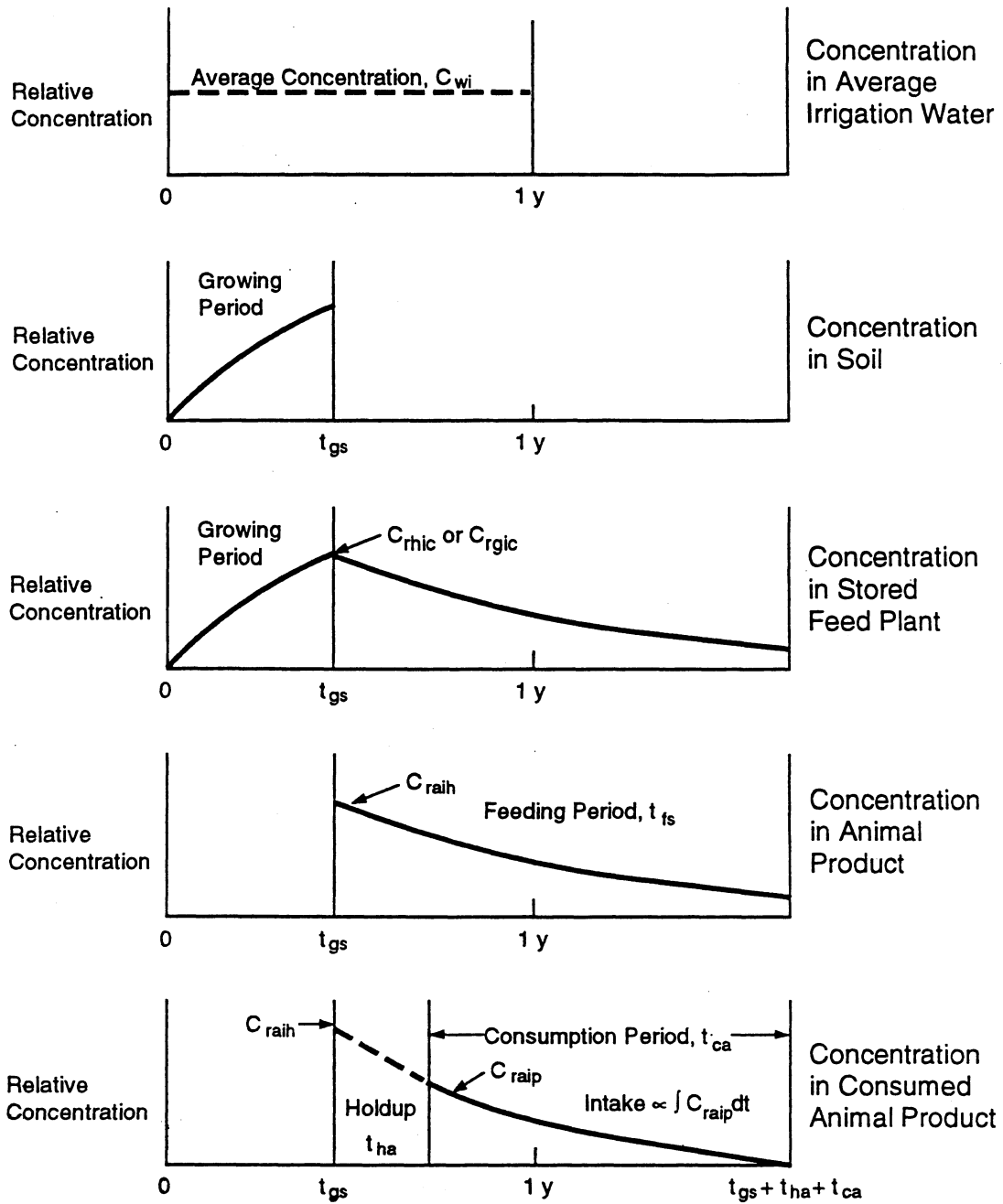

Figure 5.18 Change in relative concentrations over time for irrigation water, soil, stored feed, animal products, and human foods from deposition of irrigation water on soil with subsequent resuspension and root uptake by stored feed crops

$$C_{whjc(\text{soil})} = R \{R_{wsjg}, t_{gh}\} \quad (5.51)$$

where $C_{whjc(\text{soil})}$ = concentration factor for chain member j in soil at time of initial animal consumption of stored hay crop h , for an average concentration of parent radionuclide in water (pCi/kg dry-weight soil per pCi/L water)

t_{gh} = growing period of stored hay crop h (d)

$R \{R_{wsjg}, t_{gh}\}$ = deposition, accumulation operator used to develop the concentration factor for chain member j in soil at time of initial animal consumption of stored hay crop h , for an average concentration of parent radionuclide in water (pCi/kg dry-weight soil per pCi/L water)

and other terms are as previously defined. Explicit equations for the parent and first progeny can be written in a similar manner as shown in the example equations of Section 5.4.1.2 (Equations [5.29] and [5.30]).

The concentration of radionuclides in stored hay plants at the time of harvest (initial feeding to animals) is evaluated from the concentration of radionuclides in soil at the time of harvest. The evaluation is made using the stored hay crop concentration factor as follows:

$$C_{rhjc} = (ML_h + B_{jh}) W_h C_{whjc(\text{soil})} \quad (5.52)$$

where C_{rhjc} = concentration factor for radionuclide j in stored hay crop h at time of initial feeding to animals (harvest), resulting from root uptake and resuspension for an average unit concentration of parent radionuclide i in water (pCi/kg wet-weight plant per pCi/L water)

B_{jh} = concentration factor for uptake of radionuclide j from soil in stored hay crop h (pCi/kg dry-weight plant per pCi/kg dry-weight soil)

ML_h = plant soil mass-loading factor for resuspension of soil to stored hay plant h (pCi/kg dry-weight plant per pCi/kg dry-weight soil)

W_h = factor for conversion of mass of stored hay crop h from a dry-weight to a wet-weight basis (kg dry-weight hay per kg wet-weight hay)

and other terms are as previously defined. Equation (5.52) applies to all members of the decay chain for parent radionuclide i , including the parent.

5.4.2.5 Irrigation Water-Stored Grain-Animal-Human Pathway

This exposure pathway is analogous to the pathway involving stored hay described in Section 5.4.2.3. The time variation of relative parent radionuclide concentration in irrigation water, stored grain plants, animal products, and food eaten by humans for this pathway is as shown in Figure 5.17. The concentration of radionuclides in stored grain plants at harvest is evaluated assuming a constant deposition rate of radionuclides from irrigation water onto the grain crop during the growing season. Loss of activity from plant surfaces by weathering is considered. The stored grain is fed to the animals over a feeding period that begins immediately after harvest and continues for the feeding period.

Residential

The time rate of change of radionuclide concentration in stored grain plants is as described by Equation (5.21) for deposition onto food crop plants. The average deposition rate of radionuclides from irrigation water to plants is described by Equation (5.48) with subscript "h" for hay replaced by subscript "g" for grain, as follows:

$$R_{wgjg} = IR r_g T_g / Y_g [C_{wj} / C_{wi}] \quad (5.53)$$

where R_{wgjg} = average deposition rate of radionuclide j to stored grain crop g from irrigation water application for an average unit concentration of parent radionuclide i in water (pCi/d • kg wet-weight plant per pCi/L water)

C_{wi} = average concentration of parent radionuclide i in irrigation water over the current annual period (pCi/L water)

C_{wj} = average concentration of radionuclide j in irrigation water over the current annual period (pCi/L water)

IR = annual average application rate of irrigation water ($L/m^2 \cdot d$)

r_g = fraction of initial deposition of radionuclides in water retained on grain plant g (pCi retained on plants per pCi deposited)

T_g = translocation factor for transfer of radionuclides from plant surfaces to edible parts of grain plant g (pCi in edible plant parts per pCi retained on plant)

Y_g = yield of stored grain crop g (kg wet-weight plant/ m^2 of land)

The concentration of radionuclides in stored grain crops from deposition onto plant surfaces at the time of animal consumption is evaluated by using Equation (5.23) but with parameters defined for stored grain plants:

$$C_{wgjc} = R_e \{R_{wgjg}, t_{gg}\} \quad (5.54)$$

where C_{wgjc} = concentration factor for radionuclide j in stored grain crop g at initial time of animal consumption, from deposition onto grain plant surfaces for an average unit concentration of parent radionuclide i in water (pCi/kg wet-weight plant per pCi/L water)

t_{gg} = growing period of stored grain type g (d)

$R_e \{R_{wgjg}, t_{gg}\}$ = deposition, accumulation operator representing the concentration factor for radionuclide j in stored grain crop g at the initial time of harvest, from deposition of irrigation water onto plants for an average unit concentration of parent radionuclide i in water (pCi/kg wet-weight plant per pCi/L water)

and other terms are as previously defined. Explicit equations for the parent and first progeny radionuclides can be written as shown in the example equations in Section 5.4.1.1 (Equations [5.24] and [5.25]).

5.4.2.6 Irrigation Water-Soil-Stored Grain-Animal-Human Pathway

This exposure pathway is analogous to the pathway involving stored hay described in Section 5.4.2.4. The time variation of relative parent radionuclide concentration in irrigation water, soil, stored grain plants, animal products, and food eaten by humans for this pathway is as shown in Figure 5.18. The differential equation describing the time rate of change of radionuclide concentrations in soil is given by Equation (5.26). The constant deposition rate for a radionuclide to soil is evaluated according to Equation (5.27) with parameters defined for stored grain plants:

$$R_{wsjg} = IR / P_s [C_{wj}/C_{wi}] \quad (5.55)$$

where R_{wsjg} = average deposition rate of radionuclide j to soil from irrigation water application for an average unit concentration of parent radionuclide i in water (pCi/d • kg dry-weight soil per pCi/L water)

C_{wi} = average concentration of parent radionuclide i in irrigation water over the current annual period (pCi/L water)

C_{wj} = average concentration of radionuclide j in irrigation water over the current annual period (pCi/L water)

IR = annual average application rate of irrigation water ($L/m^2 \cdot d$).

The concentration of radionuclides in soil at the time of stored grain crop harvest is evaluated using Equation (5.51) with parameters defined for the stored grain feed type as follows:

$$C_{wgjc(\text{soil})} = R \{R_{wsjg}, t_{gg}\} \quad (5.56)$$

where $C_{wgjc(\text{soil})}$ = concentration factor for radionuclide j in soil at time of initial animal consumption of stored grain crop g , from irrigation water applied to soil for an average unit concentration of parent radionuclide i in water (pCi/kg dry-weight soil per pCi/L water)

t_{gg} = growing period of stored grain type g (d)

$R \{R_{wsjg}, t_{gg}\}$ = deposition, accumulation operator representing the concentration factor for radionuclide j in soil at time of initial animal consumption of stored grain crop g , from irrigation water applied to soil for an average unit concentration of parent radionuclide i in water (pCi/kg dry-weight soil per pCi/L water)

and other terms are as previously defined.

The concentration of radionuclides in stored grain plants from resuspension and root uptake at the time of harvest (initial feeding to animals) is evaluated from the concentration of radionuclides in soil at the time of harvest. The evaluation is made using Equation (5.52) with parameters defined for the stored grain crop as follows:

$$C_{rgjc} = [ML_g + B_{jg}] W_g C_{wgjc(\text{soil})} \quad (5.57)$$

Residential

where C_{rgjc} = concentration factor for radionuclide j in stored grain crop g at time of initial feeding to animals (harvest), resulting from resuspension and root uptake for an average unit concentration of parent radionuclide i in water (pCi/kg wet-weight plant per pCi/L water)

B_{jg} = concentration ratio for uptake of radionuclide j from soil in stored grain crop g (pCi/kg dry-weight plant per pCi/kg dry-weight soil)

ML_g = plant soil mass-loading factor for resuspension of soil to stored grain plant g (pCi/kg dry-weight plant per pCi/kg dry-weight soil)

W_g = factor for conversion of mass of stored grain crop g from a dry-weight to a wet-weight basis (kg dry-weight grain per kg wet-weight grain)

and other terms are as previously defined. Equation (5.57) applies to all members of the decay chain including the parent.

5.4.2.7 Irrigation Water-Soil-Animal-Human Pathway

This pathway results from animal ingestion of soil while grazing on fresh forage. The differential equation for the soil concentration given in Equation (5.26) applies to this pathway. Animal intake of soil while grazing is evaluated for a constant deposition rate to soil. The amount of soil ingestion by the animal is evaluated as a constant fraction of the animal intake of forage over the forage-feeding period. The deposition onto soil is evaluated as defined in Equation (5.43) and is represented as follows:

$$R_{wsjf} = IR / P_s [C_{wj}/C_{wi}] \quad (5.58)$$

where R_{wsjf} is the average deposition rate of radionuclide j to soil from irrigation water application onto soil during forage-feeding period for an average unit concentration of parent radionuclide i in water (pCi/d • kg dry-weight soil per pCi/L water) and other terms are as previously defined.

The average concentration in soil eaten by animals over the forage period is evaluated as the time integral of the soil concentration over the forage-feeding period, divided by the feeding period. The average soil concentration is evaluated according to Equation (5.44) using terms for ingestion of soil by animals:

$$C_{rfjd} = G \{ R_{wsjf}, t_{ff} \} / t_{ff} \quad (5.59)$$

where C_{rfjd} = average concentration factor for radionuclide j in soil eaten by animals during the forage period for crop f for an average unit concentration of parent radionuclide i in water (pCi/kg dry-weight soil per pCi/L water)

$G \{ R_{wsjf}, t_{ff} \}$ = operator notation used to develop the deposition, accumulation, and time integral of the transfer rate to soil for radionuclide j over the forage-feeding period for an average unit concentration of parent radionuclide i in water (pCi • d/kg dry-weight soil per pCi/L water)

and other terms are as previously defined. Explicit equations can be written for the parent and first progeny radionuclides as shown in Section 5.4.2.2 (Equations [5.45] and [5.46]).

5.4.2.8 Calculation of PPTFs for Animal Products Contaminated by Irrigation Water

The PPTFs for animal products involve summation of contributions for animal intake of forage crops (including soil ingestion), stored feed crops, and water (feeding contaminated irrigation water directly to animals). The concentration of radionuclides in forage crops (determined by Equations [5.38], [5.47], and [5.59]) are average concentrations over the feeding period. The radionuclide concentration in animal products is assumed to be in equilibrium with animal intake of these plant concentrations at all times during the feeding period. The concentration in animal products is, therefore, also constant (average) over the feeding period, evaluated as follows:

$$C_{wajh(\text{forage})} = F_{aj} Q_f x_f [C_{wfjc} + C_{rfjc} + Q_d W_f C_{rfjd}] \quad (5.60)$$

where $C_{wajh(\text{forage})}$ = average concentration at time of fresh forage intake by animal product a, for radionuclide j, for irrigation water pathway for an average unit concentration of parent radionuclide i in water (pCi/kg wet-weight animal product per pCi/L water)

F_{aj} = transfer factor that relates the concentration in an edible animal product a, to the daily intake in animal feed (stored, fresh forage, soil, or water) (pCi/L per pCi/d for milk, and pCi/kg wet-weight animal product per pCi/d for other animal products)

Q_d = fractional soil intake of fresh forage intake (kg dry-weight soil per kg dry-weight forage)

Q_f = consumption rate of fresh forage by the animal (kg wet-weight plant/d)

x_f = fraction of forage intake that is contaminated

and other terms are as previously defined.

The concentration of radionuclides in stored feed crops (determined in Equations [5.49], [5.52], [5.54], and [5.57]) represents the concentration at the beginning of the animal feeding period. The concentration in animal product at the beginning of the feeding period (instantaneous equilibrium between feed and animal product) is evaluated as the sum of the contributions from the direct deposition to plants and the root-uptake pathways:

$$C_{wajc(\text{stored})} = F_{aj} \left[Q_h x_h (C_{whjc} + C_{rhjc}) + Q_g x_g (C_{wgjc} + C_{rgjc}) \right] \quad (5.61)$$

where $C_{wajc(\text{stored})}$ = concentration factor at beginning of stored feed intake by animal product a, for radionuclide j, for irrigation water pathway for an initial unit concentration of parent radionuclide i in water (pCi/kg wet-weight animal product per pCi/L water)

Q_h = consumption rate of stored hay by the animal (kg wet-weight plant/d)

Q_g = consumption rate of stored grain by the animal (kg wet-weight plant/d)

x_h = fraction of stored hay intake that is contaminated

x_g = fraction of stored grain intake that is contaminated

and other terms are as previously defined.

Residential

The animal product concentration at the beginning of the feeding period (time of harvest) is equal to $C_{wajc(stored)}$:

$$C_{wajh(stored)} = C_{wajc(stored)} \quad (5.62)$$

The radionuclide concentration at harvest in animal products will change during the holdup period between harvest and consumption by humans. The change is represented as follows for the forage pathway:

$$C_{wajp(forage)} = A\{C_{wajh(forage)}, t_{ha}\} \quad (5.63)$$

and for the stored-feed pathway,

$$C_{wajp(stored)} = A\{C_{wajh(stored)}, t_{ha}\} \quad (5.64)$$

where $C_{wajp(forage)}$ = average concentration factor over the consumption period by humans of animal product a, for radionuclide j, for irrigation water pathway via forage crops for an average unit concentration of parent radionuclide i in water (pCi/kg wet-weight animal product per pCi/L water)

$C_{wajp(stored)}$ = concentration factor at initial time of consumption by humans of animal product a, for radionuclide j, for irrigation water pathway via stored feed crops for an average unit concentration of parent radionuclide i in water (pCi/kg wet-weight animal product per pCi/L water)

$A\{C_{wajh(forage)}, t_{ha}\}$ = decay operator notation used to develop the average concentration factor over the consumption period by humans of animal product a, for radionuclide j, for irrigation water pathway via forage crops for an average unit concentration of parent radionuclide i in water (pCi/kg wet-weight animal product per pCi/L water)

$A\{C_{wajh(stored)}, t_{ha}\}$ = decay operator notation used to develop the concentration factor at initial time of consumption period by humans of animal crop a, for radionuclide j, for irrigation water pathway via stored feed crops for an average unit concentration of parent radionuclide i in water (pCi/kg wet-weight animal product per pCi/L water)

and other terms are as previously defined.

The contribution to animal product concentration from animal intake of irrigation water over the consumption period is evaluated as follows:

$$C_{wajw} = F_{aj} Q_w x_w [C_{wj}/C_{wi}] \quad (5.65)$$

where C_{wajw} is the average concentration factor from animal ingestion of water at the time of harvest of animal product v for animal ingestion of water for an average unit concentration of parent radionuclide i in water (pCi/kg wet-weight animal product per pCi/L water), Q_w is the consumption rate of water by the animal (L/d), and x_w is the fraction of water intake that is contaminated.

The total PPTF for animal products is evaluated as follows:

$$PPTF_{awij} = \left[t_{ca} C_{wajp}(\text{forage}) + S\{C_{wajp}(\text{stored}), t_{ca}\} + t_{ca} A\{C_{wajw}, t_{ha}\} \right] / 365.25 \quad (5.66)$$

where $PPTF_{awij}$ = partial pathway transfer factor for irrigation pathway for animal product a, for radionuclide j as a progeny of radionuclide i, for an average unit concentration of parent radionuclide i in water (pCi•y/kg wet-weight animal product per pCi/L water for a year of residential scenario)

$A\{C_{wajw}, t_{ha}\}$ = decay operator notation used to develop the concentration factor for animal product a for an average unit concentration of parent radionuclide i in water from animal intake of water at the time of consumption by humans for an average unit concentration of parent radionuclide i in water (pCi/kg wet-weight animal product per pCi/L water)

$S\{\}$ = time-integral operator used to develop the concentration factor for radionuclide j concentration in animal product v over the consumption period by humans for an average unit concentration of parent radionuclide i in water (pCi•d/kg wet-weight animal product per pCi/L water)

t_{ca} = consumption period of animal product a by humans (d for a year of residential scenario)

and other terms are as previously defined.

5.5 Calculation of Pathway Transfer Factors

The PFs include the daily consumption rate of specific foods in an individual's diet and the radionuclide concentration in those foods as determined by the PPTFs. The PFs are evaluated for unit concentration in soil at the beginning of the growing season and unit concentration in irrigation water averaged over the year of exposure.

The PF for initial unit concentration of a parent radionuclide in soil is evaluated as follows:

$$PF_{sij} = \sum_{v=1}^{N_v} U_v PPTF_{vsij} + \sum_{a=1}^{N_a} U_a PPTF_{asij} \quad (5.67)$$

where PF_{sij} = agricultural pathway transfer factor for radionuclide j as a progeny of radionuclide i per unit initial concentration of parent radionuclide i in soil (pCi ingested per pCi/g dry-weight soil for a year of residential scenario)

$PPTF_{vsij}$ = partial pathway transfer factor for food crop type v, radionuclide j as a progeny of radionuclide i, for unit average concentration of parent radionuclide i in soil (pCi•y/kg wet-weight food per pCi/g dry-weight soil for a year of residential scenario)

$PPTF_{asij}$ = partial pathway transfer factor for animal product type a, radionuclide j as a progeny of radionuclide i, for unit average concentration of parent radionuclide i in soil (pCi•y/kg wet-weight food per pCi/g dry-weight soil for a year of residential scenario)

N_a = number of animal products considered in the diet

N_v = number of food crops considered in the diet

Residential

U_a = ingestion rate of animal product type a by an individual (kg wet-weight/y)

U_v = ingestion rate of food crop type v by an individual (kg wet-weight/y).

A similar expression is used to evaluate the PFs for unit average concentration of a parent radionuclide in irrigation water:

$$PF_{wij} = \sum_{v=1}^{N_v} U_v PPTF_{vwij} + \sum_{a=1}^{N_a} U_a PPTF_{awij} \quad (5.68)$$

where PF_{wij} = agricultural pathway transfer factor for radionuclide j as a progeny of radionuclide i per unit average concentration of parent radionuclide i in water (pCi ingested per pCi/L water for a year of residential scenario)

$PPTF_{vwij}$ = partial pathway transfer factor for food crop type v, radionuclide j as a progeny of radionuclide i, for unit average concentration of parent radionuclide i in water (pCi•y/kg wet-weight food per pCi/L water for a year of residential scenario)

$PPTF_{awij}$ = partial pathway transfer factor for animal product type a, radionuclide j as a progeny of radionuclide i, for unit average concentration of parent radionuclide i in water (pCi•y/kg wet-weight food per pCi/L water for a year of residential scenario)

and other terms are as previously defined. The food types and annual consumption rates are given in Section 6.

5.6 Calculation of Total Dose From Pathways for the Residential Scenario

Computing the dose for the agricultural pathways (ingestion) involves using the information provided by computation of the PPTFs and PFs. The TEDE for the residential scenario (designated as "TEDER") is obtained by adding the dose rates from the five primary pathways: external exposure, inhalation exposure, ingestion exposure without irrigation, ingestion exposure with contaminated irrigation water, and secondary soil ingestion.

5.6.1 External Dose for the Residential Scenario

For external exposure, the residential exposure scenario involves an individual who spends time at home--receiving exposure indoors, in leisure outdoors, and in gardening activities outdoors--and away from home, during which no exposure is received. The starting time for the scenario (when the unit concentration in soil is defined) is assumed to be at the start of the gardening season during the year of license termination. The external dose, designated "DEXR," involves the pathways to human exposure shown in Figure 5.19.

The external dose contribution is calculated as the sum of exposure during indoor and outdoor activities (i.e., gardening exposure + indoor exposure + outdoor exposure):

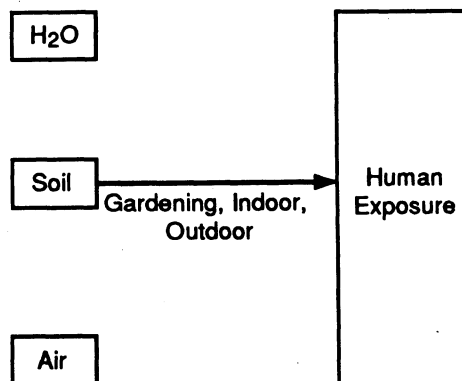

Figure 5.19 Residential scenario external dose pathway

$$\begin{aligned}
 \text{DEXR}_i = & \left[24 \left(t_g/t_{1g} \right) \text{SFO} \left(\overset{C_{si}(t)}{\underset{\downarrow}{e_{si}}} \sum_{j=1}^{J_i} S \{ A_{stj}, t_{1g} \} \text{DFER}_j \right) \right] \\
 & + \left[24 \left(t_x/t_{1r} \right) \text{SFO} \left(\underset{\downarrow}{e_{si}} \sum_{j=1}^{J_i} S \{ A_{stj}, t_{1r} \} \text{DFER}_j \right) \right] \\
 & + \left[24 \left(t_i/t_{1r} \right) \text{SFI} \left(\underset{\downarrow}{C_{si}} \sum_{j=1}^{J_i} S \{ A_{stj}, t_{1r} \} \text{DFER}_j \right) \right]
 \end{aligned} \tag{5.69}$$

where DEXR_i = external dose from 1 year of residential scenario exposure to radionuclide i in soils (mrem for a year of residential scenario)

DFER_j = external dose rate factor for radionuclide j for exposure to contamination uniformly distributed in the top 15 cm of residential soil (mrem/h per pCi/g)

A_{stj} = concentration factor for radionuclide j in soil at the beginning of the current annual exposure period per initial unit concentration of parent radionuclide i in soil at time of site release (pCi/g per pCi/g)

C_{si} = concentration of parent radionuclide i in soil at time of site release (pCi/g dry-weight soil)

SFI = shielding factor by which external dose rate is reduced during periods of indoor residence (dimensionless)

SFO = shielding factor by which external dose rate is reduced during periods of outdoor residence and gardening (dimensionless)

Residential

J_i = number of explicit members of the decay chain for parent radionuclide i

$S\{A_{stj}, t_{tr}\}$ = time-integral operator used to develop the concentration time integral of radionuclide j for exposure over a 1-year period per unit initial concentration of parent radionuclide i in soil (pCi•d/g per pCi/g dry-weight soil)

$S\{A_{stj}, t_{tg}\}$ = time-integral operator used to develop the concentration time integral of radionuclide j for exposure outdoors over one gardening season during 1-year period per unit initial concentration of parent radionuclide i in soil (pCi•d/g per pCi/g dry-weight soil)

t_g = time during the gardening period that the individual spends outdoors gardening (d for a year of residential scenario)

t_i = time in the 1-year exposure period that the individual spends indoors (d for a year of residential scenario)

t_x = time in the 1-year exposure period that the individual spends outdoors, other than gardening (d for a year of residential scenario)

t_{tg} = total time in the gardening period (d)

t_{tr} = total time in the residential exposure period (d)

24 = unit conversion factor (h/d).

The concentration time-integral factors, $S\{\}$, are evaluated for all radionuclides in a decay chain. The factors represent the time integral of concentration during the exposure period of interest.

The concentration factor, A_{stj} , defines the concentration of each radionuclide in soil in a decay chain at the beginning of the current year of the dose evaluation. The concentration includes material initially present in the soil, plus material that has migrated to ground water and been redeposited onto the farmland soil by irrigation with the contaminated water during the previous year. Evaluation of the concentration factor is described in Section 5.6.6.

5.6.2 Inhalation Dose for the Residential Scenario

Inhalation of resuspended soil dust (designated "DHR") also involves the three periods of exposure used for the external dose pathway (above), i.e., gardening, outdoor activities, and indoor activities. The indoor component includes contributions from material blown into the house (mass-loading method) and soil tracked into the house and suspended (resuspension factor method), as indicated in Figure 5.20 and the following expression:

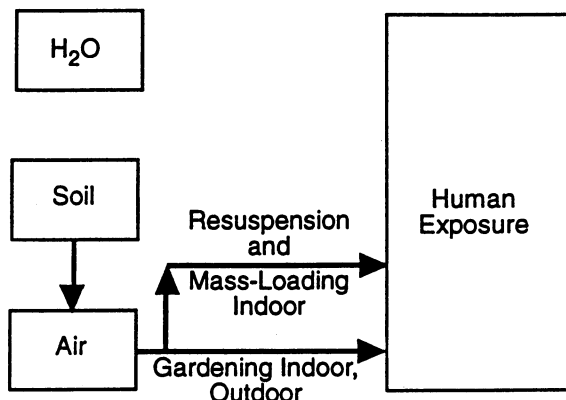

Figure 5.20 Residential scenario inhalation dose pathways

$$\begin{aligned}
 DHR_i = & \left[24 V_g \left(t_g/t_g \right) CDG \left(\epsilon_{si} \sum_{j=1}^{J_i} S \{ A_{stj}, t_{tg} \} DFH_j \right) \right] \\
 & + \left[24 V_x \left(t_x/t_{tr} \right) CDO \left(\epsilon_{si} \sum_{j=1}^{J_i} S \{ A_{stj}, t_{tr} \} DFH_j \right) \right] \\
 & + \left[24 V_r \left(t_i/t_{tr} \right) \left(CDI + P_d RF_r \right) \left(\epsilon_{si} \sum_{j=1}^{J_i} S \{ A_{stj}, t_{tr} \} DFH_j \right) \right]
 \end{aligned} \tag{5.70}$$

where DHR_i = inhalation committed effective dose equivalent from 1 year of residential activity (mrem for a year of residential scenario)

V_g = volumetric breathing rate for time spent gardening (m^3/h)

CDI = dust-loading for indoor exposure periods (g/m^3)

V_r = volumetric breathing rate for time spent indoors (m^3/h)

CDO = dust-loading for outdoor exposure periods (g/m^3)

CDG = dust-loading for gardening activities (g/m^3)

V_x = volumetric breathing rate for time spent outdoors (m^3/h)

DFH_j = inhalation committed effective dose equivalent factor for radionuclide j for exposure to contaminated air (in units of mrem per pCi inhaled)

Residential

P_d = indoor dust-loading on floors (g/m^2)

RF_r = indoor resuspension factor (m^{-1})

and other terms are as previously defined. A discussion of dust-loadings and resuspension is provided in Section 6. Evaluation of the concentration factor, A_{stj} , is described in Section 5.6.6.

5.6.3 Ingestion Dose for the Residential Scenario

This section describes the calculation of ingestion dose from agricultural products grown in contaminated soil and from secondary ingestion of soil. The pathway that involves ingestion of crops and animal products from deposition of resuspended soils on plant surfaces and root uptake (designated "DGR") is shown in Figure 5.21. The contribution to dose from this pathway is evaluated as follows:

$$DGR_i = C_{si}^{(0)} \lambda \text{DIET} \sum_{j=1}^{J_i} A_{stj} AF_{sj} \quad (5.71)$$

where DGR_i = ingestion committed effective dose equivalent from a 1-year intake of home-grown food and animal products (mrem for a year of residential scenario)

DIET = fraction of annual diet derived from home-grown foods (dimensionless)

AF_{sj} = committed effective dose equivalent factor for ingestion of agricultural product per unit concentration of radionuclide j in soil at the beginning of a growing season (mrem per pCi/g for a year of residential scenario)

$C_{si}^{(0)} \lambda$ = initial concentration of parent radionuclide in soil at the time of release of the site, i.e., the start of growing season for the first year (pCi/g)

and other terms are as previously defined.

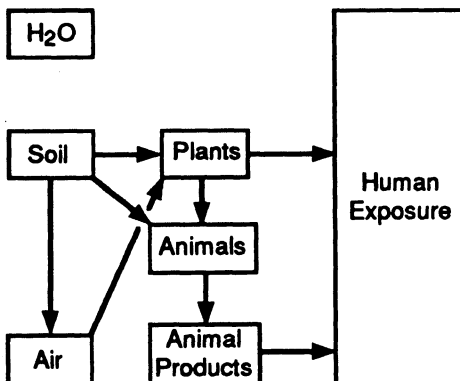

Figure 5.21 Residential scenario ingestion dose pathway for plants and animal products contaminated from soil

The agricultural product ingestion factor for soil (AF_{si}) is calculated from pathway transfer factors as follows:

$$AF_{si} = \sum_{j=1}^{J_i} PF_{sij} DFG_j \quad (5.72)$$

where PF_{sij} is the pathway transfer factor for agricultural products for soil for radionuclide j as a progeny of radionuclide i (pCi ingested per pCi/g dry-weight soil for a year of residential scenario) and DFG_j is the ingestion CEDE factor for radionuclide j (mrem per pCi ingested). Equation (5.72) is written to be applied to parent radionuclides (thus the subscript "i"). For progeny radionuclides of Equation (5.71), the AF_{sj} value is evaluated for progeny radionuclides as if for a parent of its own decay chain.

The dose from secondary (inadvertent) ingestion of soil or house dust is included in the residential scenario analysis. This pathway is shown in Figure 5.22. The individual is assumed to ingest soil at a constant rate over the duration of the scenario, t_{tr} . The dose is evaluated as follows:

$$DSR_i = GR \frac{C_{s_i}(0)}{\lambda} \sum_{j=1}^{J_i} DFG_j S\{A_{s_{ij}}, t_{tr}\} \quad (5.73)$$

$(t_i + t_k + t_g) / t_{tr}$

where DSR_i = committed effective dose equivalent for radionuclide i from ingestion of soil (mrem for 1 year of residential scenario)

GR = effective transfer rate for ingestion of soil and dust transferred to the mouth (g/d)

$S\{A_{s_{ij}}, t_{tr}\}$ = time-integral operator used to develop the radionuclide j concentration in soil, over the residential exposure period for a unit initial concentration of parent radionuclide i in soil at the time of site release (pCi•d/g per pCi/g for 1 year of residential scenario)

and other terms are as previously defined.

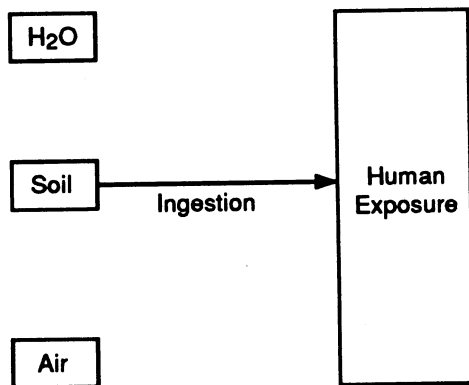

Figure 5.22 Residential scenario soil ingestion dose pathway

5.6.4 Irrigation and Drinking Water Dose for the Residential Scenario

The contribution to the ingestion dose from the use of contaminated ground water (designated "DWR") is represented in Figure 5.23. It is evaluated for drinking water and ingestion of irrigated foods, as follows:

$$DWR_i = \frac{C_{si}(0)}{C_{si}} \left[\sum_{j=1}^{J_i} A_{wtj} AF_{dj} + DIET \sum_{j=1}^{J_i} A_{wtj} AF_{wj} \right] \quad (5.74)$$

where DWR_i = committed effective dose equivalent for radionuclide i for ingestion of drinking water and irrigated food from a 1-year intake (mrem for 1 year of residential scenario)

C_{si} = initial concentration of radionuclide i in soil at the time of site release (pCi/g)

AF_{dj} = committed effective dose equivalent factor for ingestion of drinking water per unit average concentration of radionuclide j (as a parent radionuclide) in water (mrem per pCi/L for 1 year of residential scenario)

AF_{wj} = committed effective dose equivalent factor for radionuclide j per unit average concentration of radionuclide j (as a parent radionuclide) in ground water used for irrigation for the current 1-year period (mrem per pCi/L for 1 year of residential scenario)

A_{wtj} = average concentration factor for radionuclide j in water over the current 1-year exposure period per initial unit concentration of parent radionuclide i in soil at time of site release (pCi/L water per pCi/g soil)

and other terms are as previously defined.

The average water concentration factor, A_{wtj} , is evaluated according to the water-use model described in Section 5.6.6. The water concentration is based on the initial radionuclide concentration in soil, C_{si} , as used in the inhalation and external dose equations. Therefore, the ingestion dose is on the same concentration basis as the other dose values.

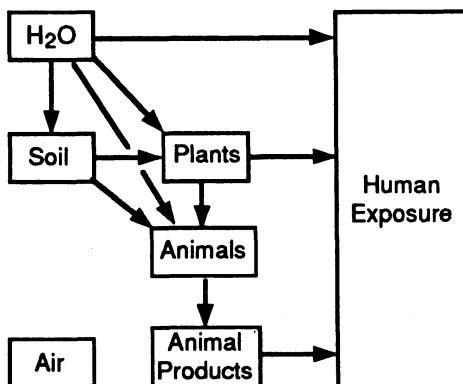

Figure 5.23 Residential scenario ingestion dose from use of contaminated ground water

The drinking water ingestion factor is calculated as follows:

$$AF_{dj} = U_w DFG_j t_d (C_{wj}/C_{wj}) \quad (5.75)$$

where U_w = daily intake of drinking water (L/d)

t_d = duration of water intake period (d for 1 year of residential scenario)

and other terms are as previously defined. The concentration ratio, C_{wj}/C_{wj} (equal to 1), indicates normalization to unit average concentration in water over the year of the residential scenario. The concentration is defined for radionuclide j as a parent radionuclide, consistent with the definition of AF_{dj} . The duration of water intake defines the amount of the individual's intake that comes from the ground-water well.

The agricultural product ingestion factor for irrigation of crops is calculated from pathway transfer factors as follows:

$$AF_{wi} = \sum_{j=1}^{J_i} PF_{wij} DFG_j \quad (5.76)$$

where PF_{wij} is the pathway transfer factor for agricultural products for irrigation for radionuclide j as a progeny of radionuclide i (pCi ingested per pCi/L for 1 y of residential scenario) and other terms are as previously defined.

5.6.5 Aquatic Food Ingestion Dose for the Residential Scenario

Ingestion of fish grown in contaminated surface waters is included as a potential exposure pathway for the residential scenario as shown in Figure 5.24. The following assumptions are made in evaluation of the dose from this pathway:

- The fish are grown in a surface-water pond of constant volume.
- The concentration of radionuclides in the surface water is equal to the concentration in the ground-water aquifer.
- The volume of the aquifer (for dilution of activity) includes the volume of the surface-water pond.
- The fish are harvested and eaten continually during the year.
- The radionuclide concentration in the fish is proportional to the radionuclide concentration in water, as determined by the bioaccumulation factor.

The dose from this pathway is based on the average annual water concentration as defined for the water-use model (see Section 5.6.6) and represented by the parameter C_{wj} for radionuclide j . The annual dose from ingestion of aquatic foods is calculated as follows:

$$DAR_i = \frac{C_{sj}(t)}{C_{sl}} \sum_{j=1}^{J_i} A_{wtj} AF_{fj} \quad (5.77)$$

Residential

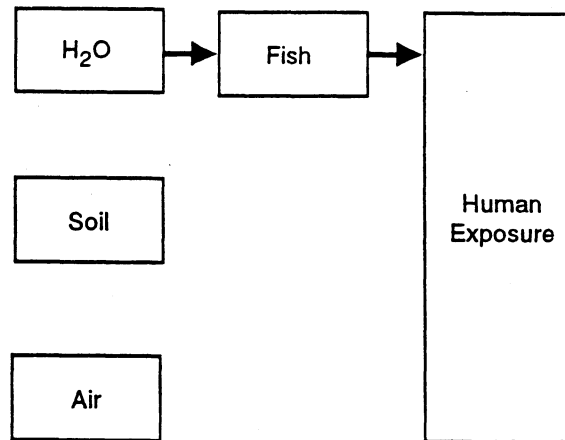

Figure 5.24 Residential scenario ingestion dose from use of contaminated ground water to grow fish in a surface-water pond

where DAR_i = ingestion committed effective dose equivalent from a 1-year intake of aquatic foods (mrem for 1 year of residential scenario)

C_{si} = initial concentration of parent radionuclide in soil at the time of site release (pCi/g dry-weight soil)

A_{wj} = average concentration factor for radionuclide j in water over the current 1-year exposure period per initial unit concentration of parent radionuclide i in soil at time of site release (pCi/L per pCi/g dry-weight soil)

AF_{fj} = committed effective dose equivalent factor for ingestion of aquatic foods per unit average concentration of radionuclide j (as a parent radionuclide) in water (mrem per pCi/L for 1 year of the residential scenario)

and other terms are as previously defined.

The aquatic food ingestion factor for water (AF_{fj}) is calculated as follows:

$$AF_{fj} = U_f t_f DFG_j BA_{jf} (C_{wj} / C_{wj}) / 365.25 \quad (5.78)$$

where U_f = ingestion rate of aquatic foods produced in contaminated surface water (kg/y)

BA_{jf} = bioaccumulation factor for radionuclide j in aquatic foods (pCi/kg wet-weight aquatic food per pCi/L water)

C_{wj} = average annual concentration of radionuclide j (as a parent radionuclide) in water (pCi/L)

t_f = duration of fish consumption period (d)

$365.25 = \text{units conversion factor (d/y)}$

and other terms are as previously defined. The ratio of concentrations of radionuclide j (as a parent radionuclide of its own chain) in water is included for consistency with representations given for other pathways, showing normalization of the concentration to the average concentration of the parent for a decay chain.

5.6.6 Water-Use Model for the Residential Scenario

This section describes the water-use model for the residential scenario and methods for evaluation of the concentration factors for soil, A_{stj} , and water, A_{wtj} . A conceptual representation of the water-use model for the residential scenario is shown in Figure 5.25. Residential radioactive contamination is assumed to be in a surface-soil layer (15-cm thick) above an unsaturated-soil layer (1-m thick), which is above a water table that feeds a surface-water pond. Activity in the surface-soil layer leaches through the unsaturated-soil layer to the aquifer. Water in the aquifer is removed from a well for application to the surface-soil layer via irrigation and for domestic uses (i.e., drinking water). The irrigation water application represents a recycling pathway from the aquifer to the surface-soil layer. The concentration of radionuclides in the surface-water pond is assumed to be the same as the concentration in the aquifer at all times. The water-use model is a three-box model similar to the water-use model described for the drinking water scenario in Section 4. The primary differences between the two models are that the residential scenario model includes a surface-water pond and recycling of activity from the aquifer to the surface-soil layer. Figure 5.25 shows the

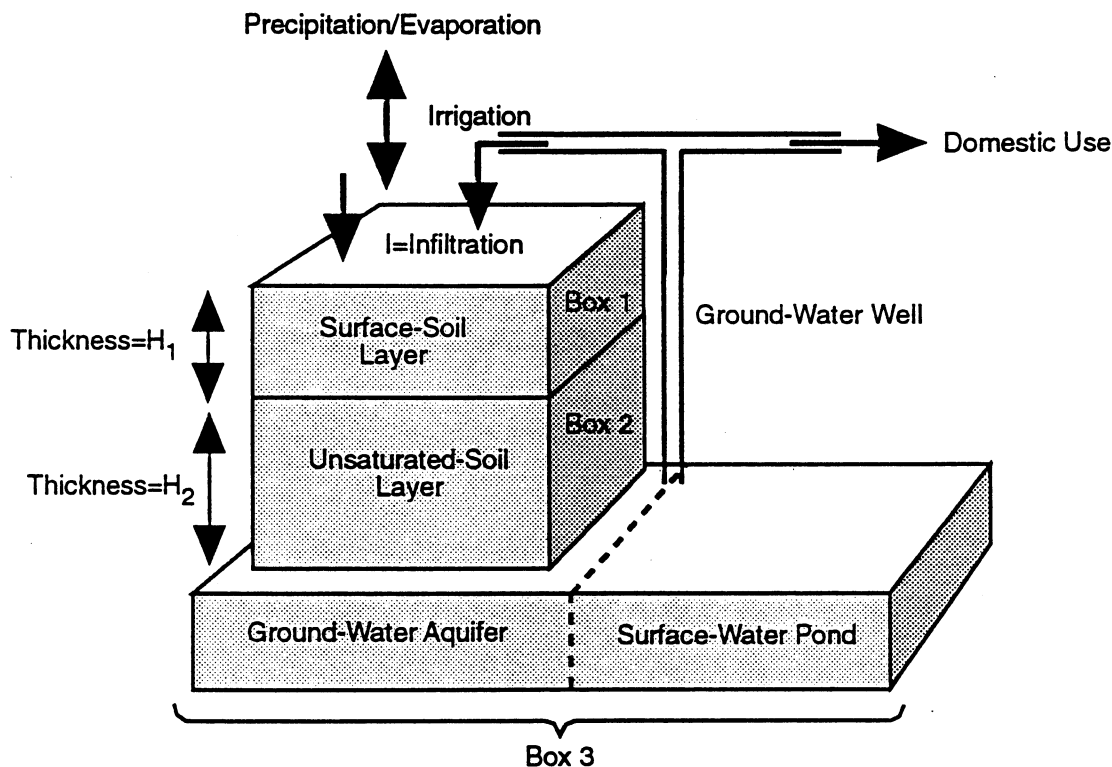

Figure 5.25 Concept representations of the residential scenario water-use model

Residential

three boxes and indicates the flow of water through the system with infiltration being the driving force for transfer from the surface soil to the ground-water aquifer. The model implies the following assumptions:

- Initial radioactivity is contained within the top layer (box 1).
- The unsaturated-soil layer (box 2) and the aquifer (box 3) are initially free of contamination.
- The vertical saturated hydraulic conductivity is greater than the infiltration rate.
- The infiltration volume is the product of the infiltration rate and the area of land contaminated.
- There is no retardation in the aquifer.
- The activity in the aquifer is diluted by the total volume of water in the aquifer.
- The radionuclide concentrations in all parts of the aquifer (including the surface-water pond) are the same: radionuclides entering box 3 are immediately uniformly mixed with the total volume of water in the aquifer.
- The total volume of water in the aquifer is constant at all times during the year.

The volume of water in the aquifer is considered to be the greater of the following: 1) the volume of infiltration water or 2) the sum of the volume of water removed annually for domestic uses and irrigation, plus the volume of the surface-water pond. The volume of infiltrating water is considered to be the product of infiltration rate, area of land irrigated, and infiltration period.

- The entire contaminated area is assumed to be irrigated and under cultivation.
- Water is removed from the aquifer at a constant rate during the year to meet the needs of irrigation and domestic water uses. The water removed is immediately replaced with uncontaminated water.
- Water is removed from the aquifer at a constant rate during all years of interest in the analysis.
- Radionuclides not removed during a year remain in the aquifer and contribute to the initial radionuclide concentration for the next annual period.
- Activity in the irrigation water is assumed to be deposited in the surface-soil layer (box 1).
- The water infiltration rate is a fraction of the total water application rate (i.e., the sum of the irrigation application rate and the annual precipitation rate).
- Evaporative losses remove only water from the system (i.e., surface soil and surface-water pond): radionuclides are not lost by evaporation.

To provide a realistic conceptual model, the volume of water in the aquifer is defined as the greater of two volumes: 1) the volume of infiltration water or 2) the volume in the surface water pond, plus the volume pumped annually for domestic and irrigation uses. This definition avoids any unrealistic case in which the volume of infiltrating water exceeds the total volume of water in the pond plus the volume of water pumped. Not using such a definition would lead to an unrealistic increase of aquifer water concentration over the concentration of the water in the unsaturated-soil layer (the source of the radionuclides reaching the aquifer).

The assumption regarding the vertical saturated hydraulic conductivity means that the soil conditions will allow water to move vertically downward at least as fast as the infiltration rate (expressed as distance per year).

Irrigation is assumed to occur continuously during a year, even during non-growing periods. This approach has been selected for simplicity for the screening model and may or may not provide conservative results, depending on the radionuclides involved.

The residential scenario water-use model can be described mathematically as a three-box model shown schematically in Figure 5.26. This figure is a diagram of the water-use model showing irrigation recycling and domestic use transfers from the ground-water aquifer. The figure also includes representation of a three-member decay chain. Equations for this water-use model are similar to the equations for the drinking water scenario, but are repeated here (with slight modification for recycling) for completeness. Recycling occurs as a result of water being removed from box 3 and used to irrigate surface soil (box 1), such as in a garden, for food production.

The water-use model is used in the residential scenario to determine the change in surface soil and aquifer concentration with time, starting with the initial activity of each radionuclide in soil at the time of site release. The process of dose evaluation for food (farm products and fish) and water-ingestion pathways, as illustrated in Figure 5.27, is evaluated sequentially, year-by-year.

The initial activity in the surface-soil layer is the starting parameter in the calculation. The dose from soil pathways is evaluated using unit dose factors for soil multiplied by the initial activity for the initial year. Unit dose factors for soil, AF_{si} , are evaluated using Equation (5.72). The average water concentration is evaluated using the water-use model. The dose from water pathways (Equations [5.74] and [5.77]) is evaluated using the average water concentration over the first year, multiplied by unit dose factors for water. The unit dose factors for water include the farm product dose factors (AF_{wi} , in Equation [5.76]), the drinking water unit dose factors (AF_{dj} , in Equation [5.75]), and the aquatic food unit dose factors (AF_{fj} , in Equation [5.78]).

The equations for the water-use model account for decay chain members produced in each of the boxes from precursor radionuclides and the transfer of each chain member between boxes and from box 3 for domestic use (drinking) and irrigation (recycling to surface soil of box 1). The amounts of each chain member are represented as the total activity present. The concepts involved in accounting for the quantity of radionuclide j in box 1 at time t are described in the word equation below:

$$\begin{aligned}
 \text{[Rate of Change of } j \text{ in Box 1 at Time } t] &= \text{[Deposition of } j \text{ from Irrigation Water]} \\
 &+ \text{[Production of } j \text{ from Decay of Precursor } n \text{ at Time } t] \\
 &- \text{[Removal of } j \text{ from Box 1 by Decay at Time } t] \\
 &- \text{[Removal of } j \text{ from Box 1 by Leaching at Time } t].
 \end{aligned}
 \tag{5.79}$$

The basic differential equation for box 1 has the following form, accounting for original quantities for irrigation deposition (w term), radioactive decay (λ terms), and rate of leaching (L term):

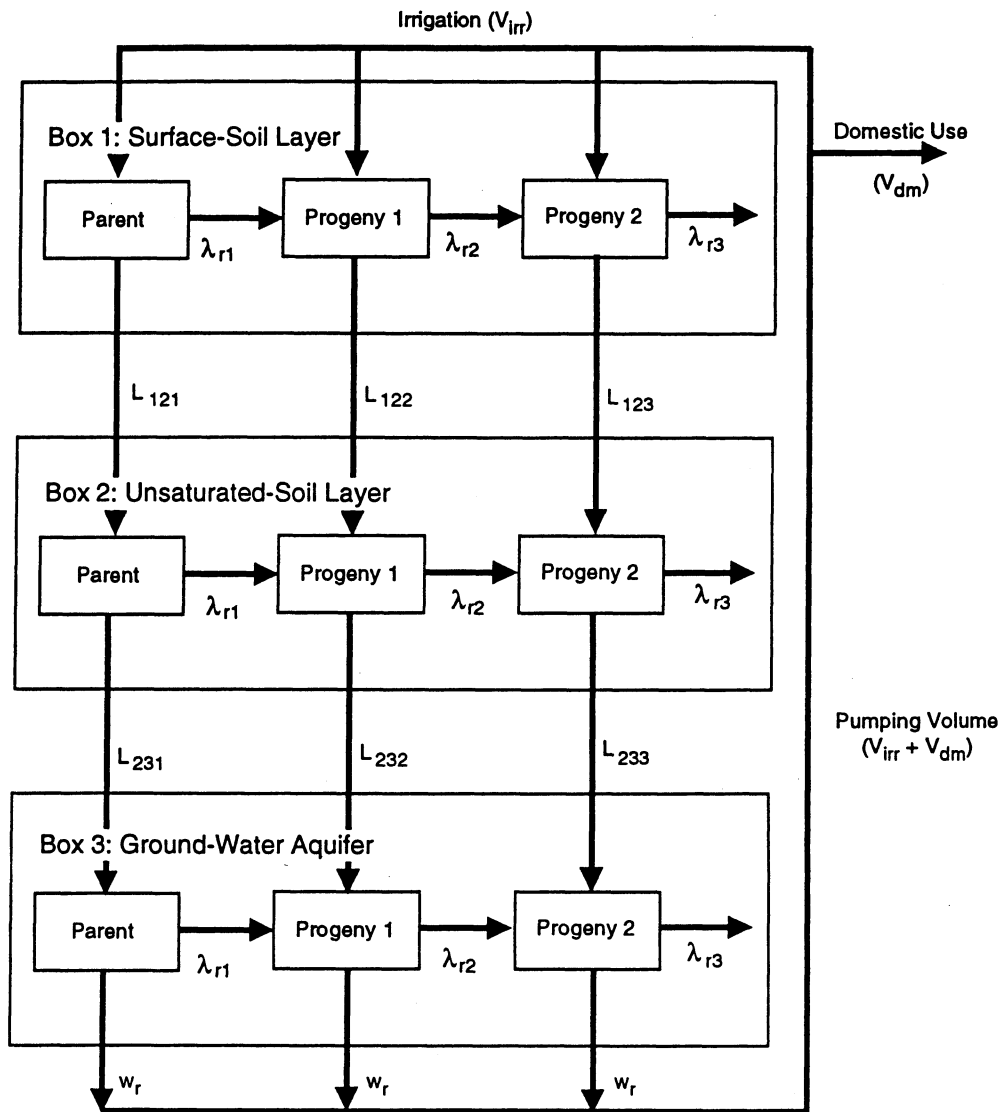
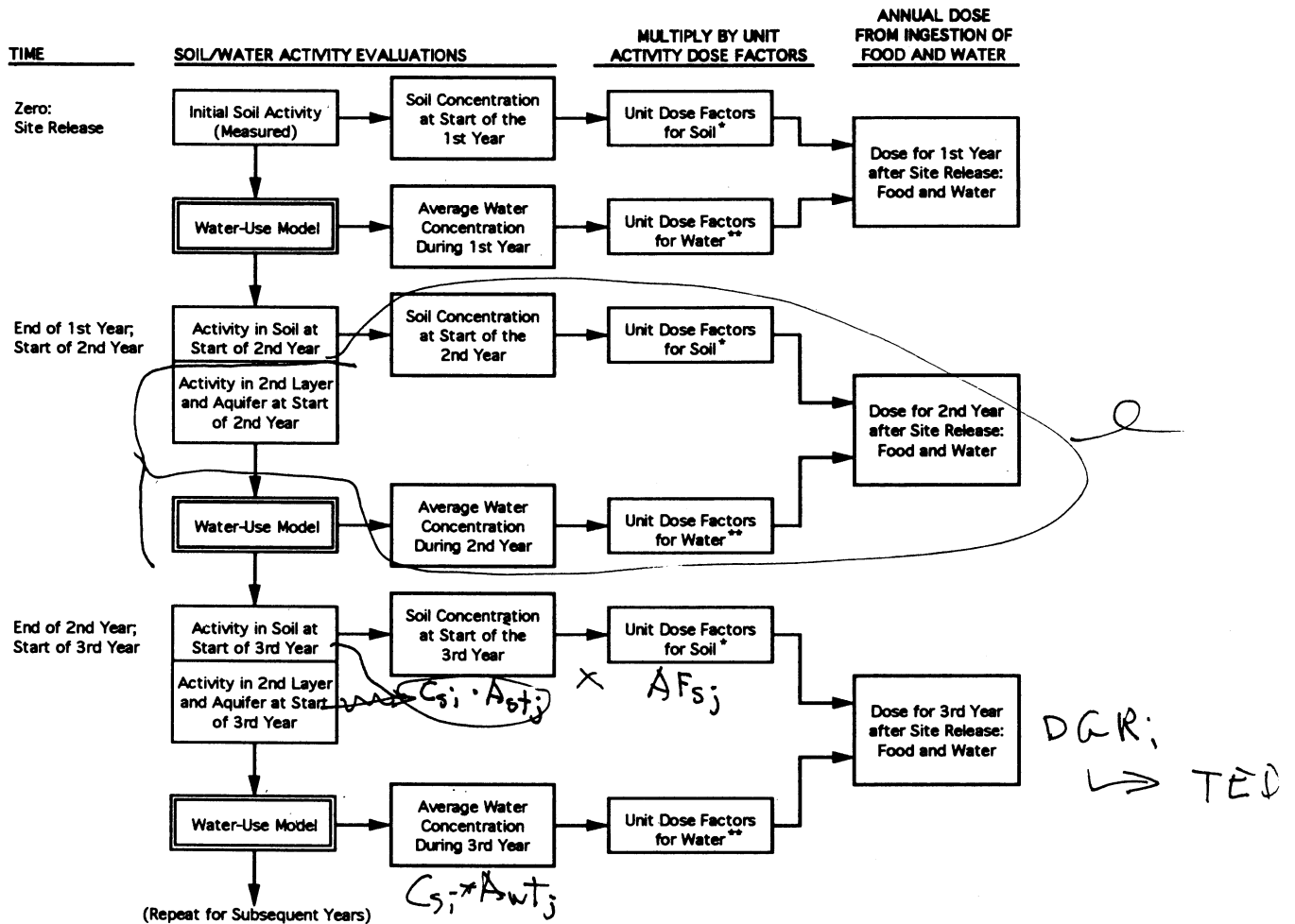

Figure 5.26 Residential three-box water-use model



* Unit dose factors for soil are AFsi [Equation (5.72)]
 ** Unit dose factors for water are AFwi [Equation (5.76)], AFdj [Equation (5.75)], and AFfj [Equation (5.78)]

Figure 5.27 Annual sequence of analyses

$$\frac{dC_{1j}}{dt} = F_r w_r C_{3j} + \lambda_{rj} \sum_{n=1}^{j-1} d_{nj} C_{1n} - (\lambda_{rj} + L_{12j}) C_{1j} \quad (5.80)$$

where C_{1j} = total activity of radionuclide j in box 1 at time t (pCi)

C_{3j} = total activity of radionuclide j in box 3 at time t (pCi)

F_r = fraction of water removed from box 3 that is deposited on the surface layer (box 1) by irrigation

w_r = removal rate constant for pumping of water from box 3 (d^{-1})

Residential

j = index of current chain-member position in decay chain

n = index of precursor chain members in decay chain ($n < j$)

C_{1n} = total activity of precursor radionuclide n in box 1 at time t (pCi)

L_{12j} = rate constant for movement of radionuclide j from box 1 to box 2 (d^{-1})

d_{nj} = fraction of transitions of radionuclide n that result in production of radionuclide j (dimensionless)

λ_{rj} = decay rate constant for decay of radionuclide j (d^{-1}).

For box 2, the concepts involved in accounting for the quantity of radionuclide j at time t are described in the word equation shown below:

$$\begin{aligned}
 &[\text{Rate of Change of } j \text{ in Box 2 at Time } t] = [\text{Production of } j \text{ from Decay of} \\
 &\quad \text{Precursor } n \text{ at Time } t] \\
 &+ [\text{Transfer of } j \text{ by Leaching from Box 1 at Time } t] \\
 &- [\text{Removal of } j \text{ from Box 2 by Decay at Time } t] \\
 &- [\text{Removal of } j \text{ from Box 2 by Leaching at Time } t].
 \end{aligned} \tag{5.81}$$

The basic differential equation for box 2 can be written as follows:

$$\frac{dC_{2j}}{dt} = \lambda_{rj} \sum_{n=1}^{j-1} d_{nj} C_{2n} + L_{12j} C_{1j} - (\lambda_{rj} + L_{23j}) C_{2j} \tag{5.82}$$

where C_{2j} = activity of radionuclide j in box 2 at time t (pCi)

C_{2n} = activity of precursor radionuclide n in box 2 at time t (pCi)

L_{23j} = rate constant for movement of radionuclide j from box 2 to box 3 (d^{-1})

and other terms are as previously defined.

For box 3, the concepts involved in accounting for the quantity of radionuclide j at time t are described in the word equation shown below:

$$\begin{aligned}
& \text{[Rate of Change of } j \text{ in Box 3 at Time } t] = \text{[Production of } j \text{ from Decay of} \\
& \quad \text{Precursor } n \text{ at Time } t] \\
& + \text{[Transfer of } j \text{ by Leaching from Box 2 at Time } t] \\
& - \text{[Removal of } j \text{ from Box 3 by Decay at Time } t] \\
& - \text{[Removal of } j \text{ from Box 3 by Pumping at Time } t].
\end{aligned} \tag{5.83}$$

The basic differential equation for box 3 can be written as follows:

$$\frac{dC_{3j}}{dt} = \lambda_{rj} \sum_{n=1}^{j-1} d_{nj} C_{3n} + L_{23j} C_{2j} - \lambda_{rj} C_{3j} - w_r C_{3j} \tag{5.84}$$

where C_{3j} = activity of radionuclide j in box 3 at time t (pCi)

C_{3n} = activity of precursor radionuclide n in box 3 at time t (pCi)

and other terms are as defined above.

The summation term in each of the above equations is evaluated for only those terms for which a transition occurs (depending on the decay scheme for the decay chain). The rate constants for movement between compartments are evaluated using the same equations as defined for the drinking water scenario water-use model (see Equations [4.7] through [4.12]).

The recycling of activity from the aquifer to the surface soil is defined by the first term on the right side of Equations (5.79) and (5.80). The pumping-rate constant, w_r , is evaluated for complete removal of the irrigation and domestic use water volume in a 1-year period. The rate constant is then the fractional removal of the total aquifer volume per year and is expressed as follows:

$$w_r = \frac{\text{Fractional Removal}}{y} \left(\frac{y}{365.25 \text{ d}} \right) \tag{5.85}$$

where 365.25 is the units conversion factor (d/y). The fractional removal is the fraction of total aquifer volume that is removed during a year. The volume removed is that associated with irrigation water use plus domestic use; the water in the farm pond is not removed. The fractional removal is then evaluated as follows:

$$\text{Fractional Removal} = \frac{V_{\text{irr}} + V_{\text{dr}}}{V_{\text{Tr}}} \tag{5.86}$$

where V_{irr} = volume of water used for irrigation during a 1-year period (L)

V_{dr} = volume of water used for domestic purposes during a 1-year period (L)

Residential

where V_{Tr} = total volume of water in the aquifer for dilution of activity over a 1-year period for the residential scenario (L).

The total volume of water in the aquifer is used as the dilution volume in determining the annual average water concentration. The total water volume is taken as the greater of the infiltration water volume or the sum of the water volumes used for irrigation, domestic purposes, and the surface-water pond. The infiltration volume is evaluated as follows:

$$V_{Ir} = I A_v 1000 \cdot 1 \quad (5.87)$$

where V_{Ir} = annual infiltration and irrigation volume through the cultivated farmland area (L)

I = infiltration rate (m/y)

A_v = area of land under cultivation (m²)

1000 = unit conversion factor (L/m³)

1 = time period for infiltration and irrigation (y).

The total volume of water in the aquifer for the residential scenario is then evaluated as follows:

$$V_{Tr} = \text{greater of: } V_{Ir} \text{ and } V_{irr} + V_{dr} + V_{sw} \quad (5.88)$$

where V_{sw} = volume of water in surface-water pond used for growing fish during a 1-year period (L)

and other terms are as previously defined.

The fraction of removal water that is applied to the surface layer is evaluated from the water usage volumes for irrigation and domestic uses as follows:

$$F_r = V_{irr} / (V_{irr} + V_{dr}) \quad (5.89)$$

The soil concentration factor for radionuclide j at the beginning of the current 1-year exposure period is represented in terms of the residential scenario water-use model operator as follows:

$$A_{stj} = A_{r1} \{ C_{kj}^{(0)} \} / C_{si}^{(0)} \quad (5.90)$$

where A_{stj} = concentration factor for radionuclide j in soil at the beginning of the current 1-year exposure period per initial unit concentration of parent radionuclide i in soil at time of site release (pCi/g dry-weight soil per pCi/g dry-weight soil)

$A_{r1}\{\}$ = residential scenario water-use model decay operator notation used to develop the concentration factor for radionuclide j in soil at the beginning of the current 1-year exposure period per initial unit concentration of parent radionuclide i in soil at time of site release (pCi/g dry-weight soil per pCi/g dry-weight soil)

$C_{kj}(0)$ = concentration array of radionuclides (j) in box k at the time of site release (pCi/g dry-weight soil)
 $C_{si}(0)$ → $C_{kj}(0)$ = initial concentration of radionuclide i in soil at the time of site release (pCi/g dry-weight soil)
 t = time between site release and the beginning of the current 1-year period (d).
water-use model

The normalization of the concentration factor results from setting the initial concentrations in surface soil to unit concentration (pCi/g of parent radionuclide). A detailed description of the water-use operator is given in Appendix B, Section B.7).

To evaluate the water concentration factor, the total activity in the farmland soil must be determined. The initial inventory for the residential scenario is given per gram of soil (box 1), unlike the drinking water scenario, in which the initial inventory is defined as the total activity in soil. The water-use model equations involve activity independent of any normalization by mass. Therefore, the total activity present in the surface layer must be determined in order to evaluate the water concentration in the aquifer. For the first level of screening, the total activity in the soil layer (per unit activity in soil, pCi/g dry-weight soil) is calculated from the total mass of soil using the irrigated area, soil depth, and soil density as follows:

$$QT = A_r H_1 d_s 10^6 \quad (5.91)$$

where QT = total mass of soil in the irrigated surface-soil layer (box 1) (g dry-weight soil)

A_r = area of land contaminated for the residential scenario (m^2)

H_1 = thickness of surface-soil layer, i.e., plow depth (m)

d_s = average density of surface-soil layer (g dry-weight soil/ cm^3)

10^6 = unit conversion factor (cm^3/m^3).

The average water concentration factor, A_{wtj} , is evaluated from the time integral of radionuclide activity in the aquifer (box 3), $S_{r3}\{C_{kj}, t_y\}$ over the current year. The total activity in the aquifer is the product of the time integral and the total soil mass, QT , divided by the time period (1 year). This total activity is divided by the total water volume to obtain the average water concentration during the current year. The calculation of the average water concentration factor is performed as follows:

$$A_{wtj} = \frac{QT S_{r3}\{C_{kj}^{(t)}, t_y\}}{V_{Tr} t_y C_{si}(0)} \quad (5.92)$$

where A_{wtj} = average concentration factor for radionuclide j in ground water during a year t per initial unit concentration of parent radionuclide i at time of site release (pCi/L per pCi/g dry-weight soil)

$C_{kj}^{(t)}$ = *concentration* initial activity of chain member radionuclide j in water-use model box k per unit activity of parent radionuclide i at the beginning of the current year (pCi/g dry-weight soil per pCi/g dry-weight soil) *in surface layer*

Residential

t_y = 1-year period of integration (d)

$S_{r3}\{\}$ = time-integral operator used to develop the residential scenario water-use model total aquifer activity for radionuclide j in ground water over a 1-year period per initial unit concentration of parent radionuclide i at time of site release (pCi•d/g dry-weight soil per pCi/g dry-weight soil)

and other terms are as previously defined. A detailed description of the residential scenario water-use time-integral operator is given in Section B.7.

5.7 Total Dose for Residential Scenario

The annual TEDE (designated "TEDER") for the residential scenario is evaluated as the sum of the contributions from the six exposure pathways:

$$\text{TEDER}_i = \text{DEXR}_i + \text{DHR}_i + \text{DGR}_i + \text{DWR}_i + \text{DSR}_i + \text{DAR}_i \quad (5.93)$$

where TEDER_i is the annual TEDE for radionuclide i (mrem for a year of residential scenario) and other terms are as previously defined. To obtain normalized annual TEDEs, the calculations are performed with a normalized source term (i.e., 1 Bq/g or 1 pCi/g). The annual TEDE is evaluated for each year until a maximum is found.

The evaluation of the annual TEDE for the residential scenario for mixtures involves calculation of the annual TEDE summed over all radionuclides in the inventory. The year of maximum dose is the year during which this *summed* dose is maximum. The annual TEDE for a mixture can be represented as the sum of annual TEDEs from individual radionuclides:

$$\text{TEDER}_m = \sum_{i=1}^M \text{TEDER}_i \quad (5.94)$$

where TEDER_m is the annual TEDE for the mixture of radionuclides, evaluated at the year in which the total is a maximum value (mrem for a year of residential scenario), and M is the number of radionuclides in the mixture.

The corresponding annual TEDEs in units of μSv , when inventory is given in units of Bq/g, are evaluated as follows:

$$\text{TEDER}_{iSI} = 270.3 \text{ TEDER}_i \quad (5.95)$$

where the constant 270.3 is a unit conversion factor ($\mu\text{Sv/Bq}$ per mrem/pCi).

6 Selected Parameter Values

As described in the previous sections, the calculation of radiation doses for the generic screening scenarios and pathways established for residual radioactive contamination in buildings and soil rely on numerous parameters and data values. These include radioactive decay data, basic dose conversion factors, media-specific concentration data, water-use model data, and data used to describe the agricultural pathways. This section explains the selection of data used in this study and justifies the selections made.

6.1 Radioactive Decay Data

Many of the models employed in the calculation of the annual TEDE require consideration of radioactive decay for radionuclide decay chains. The most notable decay chains include the multiple radionuclides in the neptunium, uranium, actinium, and thorium series. A method for handling chain decay in preparation of dose factors has been devised that is easy to implement in a computer program. This section describes the conventions developed for handling radioactive decay chains, the method for evaluation of decay with time, and the radioactive decay database.

6.1.1 Conventions for Handling Radioactive Chain Decay

The following basic conventions for handling radioactive chain progeny are defined for the calculation of annual TEDEs for residual radioactive materials:

1. A single master set of radionuclides (shown in Appendix E, Table E.1), with over 200 entries for single and multiple member decay chains, was selected by the authors for this screening model. This master set is intended to include the more significant radionuclides used by NRC licensees, including numerous short-lived radionuclides.
2. All dose values generated by the scenario analysis will be normalized to unit activity of the parent radionuclide.
3. The radiations included in the dose factor for a parent are those associated with decay of the parent, plus radiations from progeny that are always in secular equilibrium (constant ratio of activity as a function of time). For this study, radioactive decay chain members are assumed to be in secular equilibrium with parent radionuclides if they have half-lives 1) less than 9 hours and 2) less than one-tenth the listed parent half-life. Radiations from decay chain members that meet these criteria are included with the radiations from their parent radionuclides as *implicit* progeny in the dose factor listings. Several implicit progeny may be defined under one parent. Progeny that are not implicit are defined as *explicit*.

The 9-hour half-life cutoff value was selected as a convenient break point. For the master listing of radionuclides considered in this study, there is a group of radionuclides (within decay chains) with half-lives just above 9 hours, but only a few with half-lives immediately below 9 hours. Use of other notation, such as the "+ I" or "+ D" found in the public comment draft version of this document (Kennedy and Peloquin 1990), is not necessary because the progeny contributions are always included (for external or internal dose factors). Thus, it makes no practical sense to define factors without such progeny contributions. For inhalation and ingestion dose factors, the entries include radiations from all radionuclides contributing to internal dose following intake of the parent (within the 50-year dose commitment period). The inclusion of such contributions is justified by recommendations of the ICRP 26 (1977) and in EPA Federal Guidance Report No. 11 (Eckerman, Wolbarst, and Richardson 1988). These contributions are included in the inhalation and ingestion dose factors to be used for the calculations.

4. For decay chains having two or more radionuclides of significant half-life that reach secular equilibrium (constant ratio of activity as a function of time), an entry is provided giving dose factors for the entire chain. Such decay chains have a long-lived parent with progeny of varying shorter half-lives. This representation is of particular value for radionuclides in the four actinide decay series (the neptunium, uranium, actinium, and thorium series). The radionuclide notation includes a "+C" to indicate that *all* progeny in the chain are included in the dose factors. Entries are included for a decay chain member with a "+C" representation when *all* progeny of the chain have half-lives less than one-tenth the half-life of the listed member.

These conventions are sufficient to define a useful and consistent method of handling radioactive decay chains for use in development of dose factors for both internal and external exposures. It should be noted, with respect to internal dose factors, that the users of the tabulated dose factors need only be concerned about the radionuclide inventory present at the time of site release; the contributions from progeny radionuclides after intake (inhalation or ingestion) are automatically included in the evaluation of the annual TEDE.

6.1.2 Decay Chain Data

The radioactive decay chain database contains decay data for the master list of radionuclides defined for this report. The decay chain representations in the database are taken from ICRP Publication 38 (ICRP 1983). The database contains a data set for each radionuclide or chain, except natural thorium and natural uranium, for which dose factors are calculated from entries for the radionuclides in the decay chain. For single-member chains (i.e., no progeny), the data set contains the radionuclide name, decay half-life, and atomic number. Decay chains having progeny also contain listings for each chain member, including the radionuclide name, decay half-life (explicit members only), atomic number, and branching information. A complete tabulation of radioactive decay chain data contained in the database is presented in Appendix E, Table E.1. The tables in Appendix E were generated from computer-readable electronic files anticipating their direct use in the user-friendly software implementing the scenario/pathway analysis for residual radioactive contamination.

The entries in the radioactive decay chain database in Table E.1 are organized by increasing atomic number and by decay chain. Within each decay chain, members follow according to their decay sequence. The treatment of progeny radionuclides as implicit or explicit is indicated in Table E.1 by the presence of a value for the radioactive half-life. Implicit radionuclides have no value for the radioactive half-life, while explicit radionuclides have the half-life listed. The table also includes a chain member position index, with the parent always having position 1. The position indices are used to indicate the decay sequence, which is necessary when branching occurs. Implicit radionuclides have no chain member position index because they are not included in the decay calculations performed by the decay processor.

As an example of definition of implicit and explicit radionuclides, consider the entry for ^{232}U . The ^{232}U chain has three explicit progeny: ^{228}Th , ^{224}Ra , and ^{212}Pb . The data set for ^{232}U contains data for all four radionuclides as explicit chain members. Another data set is included with ^{228}Th as the parent with two explicit progeny, ^{224}Ra and ^{212}Pb . A third data set is included with ^{224}Ra as the parent with one explicit progeny, ^{212}Pb . The ^{224}Ra data set also has two implicit progeny, ^{220}Rn and ^{216}Po . Note that no half-life values are given for the two implicit progeny. The ^{212}Pb data set has three implicit progeny: ^{212}Bi , ^{212}Po , and ^{208}Tl . Note that implicit progeny are listed only once in the database and are listed under the explicit radionuclide that is their immediate precursor. This method for definition of decay chain data involves some duplication of information but greatly simplifies input and usage of the decay data in the calculations performed. It permits direct consideration of a complete or partial decay chain.

The branching information listed in Appendix E defines the sequence and fraction of parent decays that result in the production of each chain member. The branching fractions defined for each member indicate the source of production of the chain member. This convention is the opposite of the usual method of defining the fractions for the parent and

an indication of the radionuclides produced by the parent decay. A chain member may be produced by one or two precursor chain members. The decay chain database in Appendix E contains the following information:

- index of the first precursor (if any) for the chain member
- fraction of first precursor decays that result in production of the chain member
- index of the second precursor (if any) for the chain member
- fraction of second precursor decays that result in production of the chain member.

The decay fractions for implicit progeny represent the *total* fraction of explicit precursor decays that result in production of the implicit progeny. The atomic number as provided in the radioactive decay database is used as a cross-reference index with other element-specific data.

6.2 Dosimetry Database

For purposes of the generic screening analysis for evaluating the annual TEDE for the building and soil scenarios, a standardized database of external dose rate conversion factors and internal CEDE factors is required. These conversion factors are obtained from existing Federal Guidance published by the EPA, implementing the recommendations of the ICRP. A complete listing of these factors is provided in Appendix E (Table E.2). Ingestion organ dose equivalents, used to determine the organ with the highest dose in the drinking water scenario (as described in Section 4), are given in Tables E.3 through E.5.⁽¹⁾ The following sections discuss the literature sources for the external dose rate conversion factors and the internal CEDE rate conversion factors, and additional details on their selection and use.

6.2.1 External Dose Rate Conversion Factors

The external dose rate conversions used in this study were obtained directly from the EPA Federal Guidance report No. 12 developed by Oak Ridge National Laboratory (ORNL) (Eckerman and Ryman 1992). These factors provide the external effective dose equivalent by summing the product of individual organ doses and organ weighting factors over the body organs. These factors are consistent with ICRP 26 (1977) guidance; however, they are inconsistent with the concept of deep dose equivalent, as defined by the NRC (see Appendix F, "Glossary"). For purposes of this generic study, the EPA factors are judged to be an adequate representation of the external dose because skin is not considered as one of the organs. For most radionuclides, the numerical difference between the effective dose equivalent evaluated without skin and the deep dose equivalent will be a few percent. If skin were included, the difference would likely be greater for radionuclides with low photon energies. The external dose rate conversion factors from the EPA are used to determine factors for the three source conditions used for this study: 1) infinite surface (thin-layer) contamination (for surface sources in the building occupancy scenario), 2) volume contamination in a 15-cm-thick slab source (for thin volume sources used in the building renovation scenario), and 3) volume contamination in a 15-cm-thick slab source (for surface-soil sources used in the residential scenario). A listing of the external dose conversion factors for exposure to surface and volume sources is provided in Table E.2 for the radionuclides considered in this study. These factors are in units of

- Sv/d per Bq/m² for external exposure to surface sources and

(1) Please refer to the text of Appendix E for a description of the structure of these dose factor tables.

Parameter and Data Values

- Sv/d per Bq/m³ for external exposure to volume sources.

As described in Sections 2 and 5, the dose rate conversion factors need to generically account for different conditions. For the building scenarios, a variety of contamination conditions could exist, including inhomogeneous distributions of residual radioactivity on building walls, ceilings, and floors, and surface or volume sources. As described in Appendix A of the 1990 review draft of this document (Kennedy and Peloquin 1990), sensitivity studies were conducted to determine the best geometries for use in a generic analysis. A sensitivity study was conducted with an arrangement of surface (disk) sources contaminated with ⁶⁰Co and using the ISOSHL D computer program (Engel, Greenberg, and Hendrickson 1966) to model potential external doses in a room. The room was assumed to have a fixed distance 3 m from ceiling to floor, with variable floor and ceiling areas to represent different room volumes. The dose location was assumed to be the center of the room. Figure 6.1 illustrates the potential effect of uniform and nonuniform distributions on the relative external dose rate within a room, as a function of room size (volume). For further comparison, the figure contains a line that represents the dose rate from an infinite flat plane source. The room surface results for a uniform distribution of surface contamination are based on the assumption that the same contamination level exists on all interior building surfaces (walls, floor, and ceiling). The nonuniform distribution results are intended to represent a perhaps more common situation, where the floors are more contaminated than the walls or ceiling. The nonuniform distribution results are based on walls and a ceiling that have contamination levels 50% and 10%, respectively, of the contamination level on the floor. The results show that the uniform distribution dose rates are about

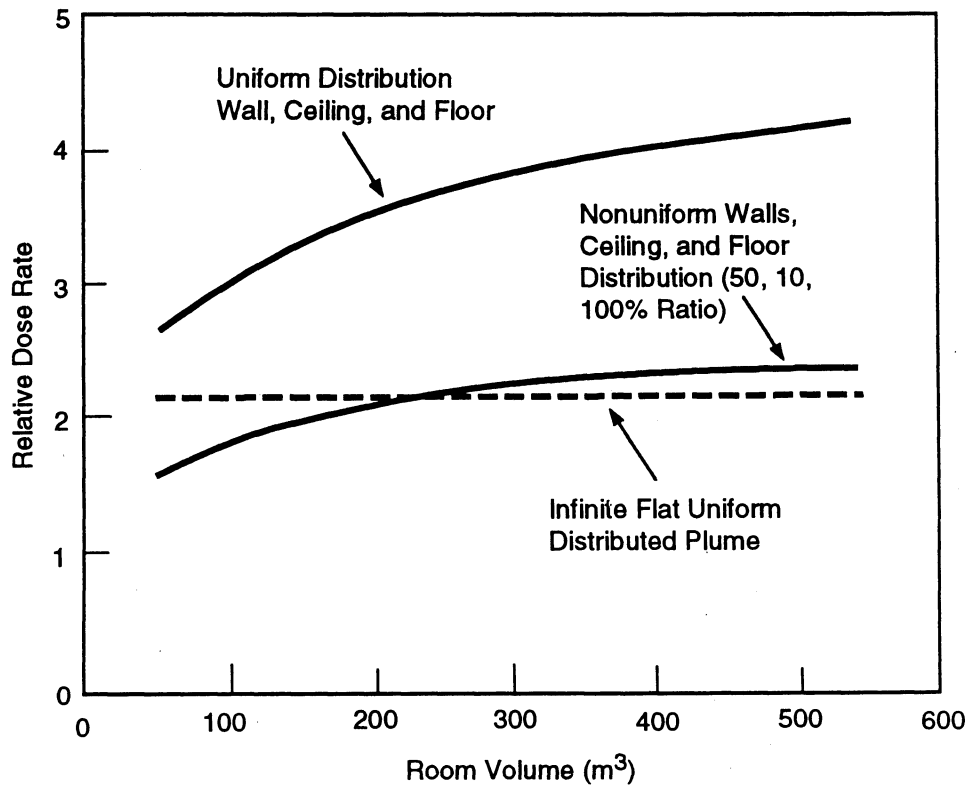

Figure 6.1 Relative external dose rate for uniform and nonuniform source distributions on interior surfaces of a room as a function of room volume

twice the dose rates from the nonuniformly distributed sources. The reason is that the contribution from the ceiling has the effect of doubling the dose rate from the floor when contamination is uniformly distributed. The contributions from the walls are minimal for medium-to-large rooms. (They are farther away from the receptor than the floor or ceiling, and thus have little contribution to the total dose.)

The results shown in Figure 6.1 indicate that external dose rate results for the infinite flat plane (with a uniform distribution of radioactive contamination) provide a good approximation of the external dose rate for rooms with non-uniform distributions of contamination levels. For reference, the two results are about equal for rooms with a volume of about 200 m^3 (a floor area of $8 \times 8 \text{ m}$ with a ceiling height of 3 m). For smaller rooms, such as most offices, the infinite flat plane result provides a conservative estimate of the potential dose rates when nonuniform contamination conditions are present. For this reason, external doses are estimated using an infinite plane source for the building occupancy scenario and an infinite slab source with a thickness of 15 cm for the building renovation scenario. These geometries are assumed to provide a prudently conservative basis for estimating external radiation doses inside contaminated rooms.

For the building renovation scenario, special consideration was given to the selection of a prudently conservative external exposure volume source configuration. With the exception of sources resulting from neutron activation, most volume activity in buildings will be limited to small areas (hot spots) or rather shallow sources (i.e., liquid spills absorbed into wall or floor surfaces). For the case of neutron activation, volume sources could extend deep into the volume of a building structure; however, these volume sources will likely be identified and removed during decontamination. The construction of most building walls and floors will likely range from thicknesses of about 10 to 30 cm . The thickness of building structural materials will place a limit on the potential thickness for volume sources. As a prudently conservative assumption, building surfaces are assumed to be represented by slab sources, of infinite extent, with a thickness of 15 cm . For external exposure calculations, this thickness will approximate an infinite thickness for alpha-emitters, beta-emitters, and x-ray or low-energy photon-emitters. For high-energy photon-emitters, a source thickness of 15 cm represents 85% of the dose rate from an infinite source as described by the sensitivity analysis for soils that follows. For contaminated soil, a sensitivity study was conducted to determine the best source geometry for estimating radiation doses in the residential scenario. Appendix A of the January 1990 comment draft (Kennedy and Peloquin 1990) report shows the external dose rates as a function of various source geometries and source areas. Figure 6.2 in this report illustrates relative external dose rates for ^{60}Co for five source thicknesses: 1 , 15 , and 50 cm and 1 and 2 meters for effective source areas between 10 and $10,000 \text{ m}^2$. The units used in the sensitivity study have been normalized to a unit activity per unit mass, and the relative dose rates are shown. As can be expected, the relative external dose rate increases as a function of source area and thickness because of an increase of the total activity present. This increase occurs over a range until an approximation to an infinite source area and thickness is reached (at a surface area of about $1,000 \text{ m}^2$ and a source thickness of about 0.5 m , as shown in Figure 6.2). It should be noted that the effect of increasing source thickness and area will also be a function of the photon energy associated with the radionuclides in the residual contamination. However, it should also be noted that the use of ^{60}Co in the sensitivity study, with two high-energy gammas, provides a prudently conservative basis for understanding the change in relative external dose rate as a function of source area and thickness.

As shown in Figure 6.2, the difference in the estimated external dose rate for source thicknesses of 15 cm and 1 m is about 15% over all source areas. It should be noted that the 15-cm solution can be assumed to represent sources thinner than 15-cm if part of the scenario considers plowing the land. Plowing is assumed to create a homogeneous volume source, 15-cm thick.

For this generic analysis, external doses from contaminated soil are modeled with a single source representation: a slab source, 15-cm thick, and of infinite extent. As described by the EPA (Eckerman and Ryman 1992), the volume source geometry used to calculate the external dose rate conversion factors is a slab source of infinite extent (a distance

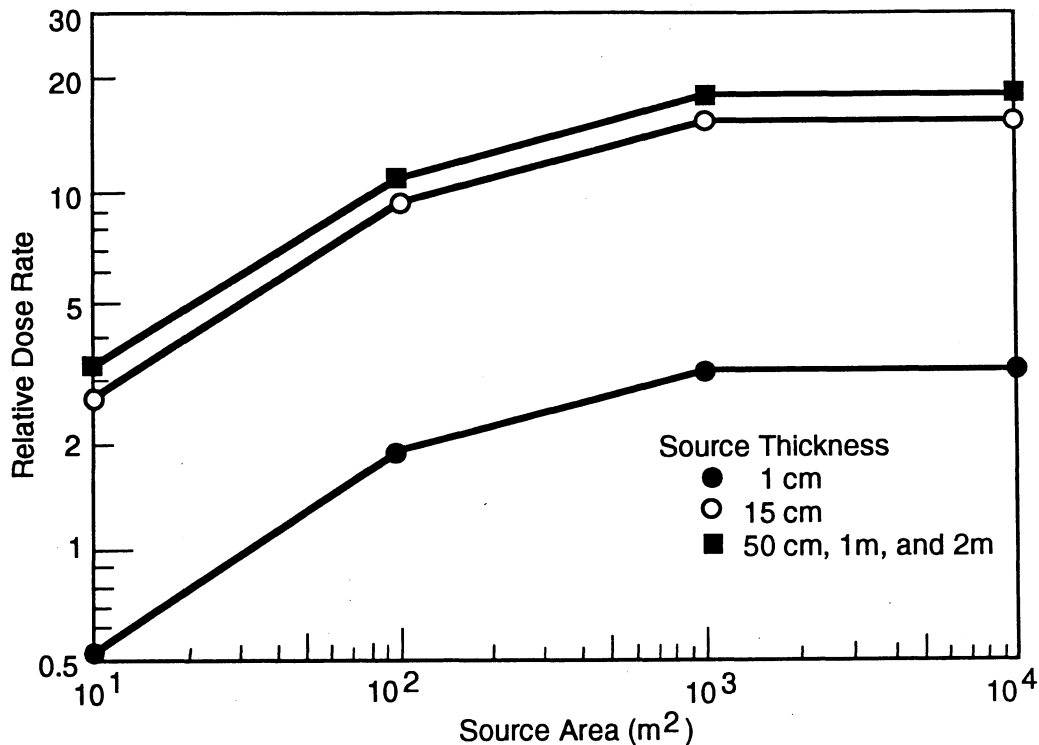

Figure 6.2 Relative external dose rate as a function of soil source area and thickness for ⁶⁰Co

of four mean free paths for each photon energy group). This geometry represents a prudently conservative approximation and is consistent with the soil thickness assumed for the plow layer in the agricultural pathway analysis.

The intent of this study is to produce screening values that should adequately bound most situations. When more complex situations arise, such as the presence of inhomogeneous, buried sources in soil, site-specific modeling or the use of external exposure measurements may better describe the situation and should be used instead of the simple model representations provided here.

6.2.2 Inhalation and Ingestion Dose Conversion Factors

For inhalation and ingestion of radioactive materials, unit CEDE conversion factors are obtained from EPA Federal Guidance Report No. 11 (Eckerman, Wolbarst, and Richardson 1988). This Federal Guidance Report supersedes previous Federal Radiation Council (FRC) guidance and, in addition to listing CEDE conversion factors per unit intake, it presents values for derived annual limits on intake (ALIs) and derived air concentrations (DACs). The unit CEDE conversion factors for inhalation and ingestion from the EPA references are included in Table E.2 in Appendix E for the radionuclides considered in this study. These factors are in units of Sv/Bq inhaled or ingested. Ingestion organ dose equivalents for the drinking water scenario are listed in Tables E.3 through E.5. These internal dose conversion factors are based on the recommendations of the ICRP in Publication 30 (1979-1988). For plutonium and related elements, the factors include the revised ICRP recommendations concerning metabolic data found in Publication 48 (1986). The dose conversion factors in EPA Federal Guidance Report No. 11 are intended for general use in assessing average individual committed doses in any population that can be characterized by Reference Man, as described by the ICRP (1975).

6.2.3 Dose and Dose Rate Factor Working Units

The dose and dose rate factors provided in the dosimetric files by the EPA are presented in units different from those needed for the scenario analyses. Conversion of the factors to the desired units, consistent with the units described in Sections 3, 4, and 5, is performed using unit conversion factors presented in this section.

Estimates of external doses from exposure to direct penetrating radiation require the use of dose rate conversion factors that are given in units of mrem/h per pCi/g (and $\mu\text{Sv/h}$ per Bq/g) for soil or volume contamination in a building, or mrem/h per dpm/100 cm^2 (and $\mu\text{Sv/h}$ per Bq/100 cm^2) for surface contamination in a building. Table 6.1 lists the unit conversion factors used to convert the basic dose rate factors in the EPA data files (Table E.2) to the desired units for this study.

Table 6.1 Unit conversion factors for external dose

Units of EPA database parameter	Multiply by	To obtain value in units
Sv/d per Bq/m ²	6.944E+03	mrem/h per dpm/100 cm ²
Sv/d per Bq/m ²	4.167E+06	$\mu\text{Sv/h}$ per Bq/100 cm ²
Sv/d per Bq/m ³	2.505E+08	mrem/h per pCi/g
Sv/d per Bq/m ³	6.771E+10	$\mu\text{Sv/h}$ per Bq/g

The conversion factors of Table 6.1 are determined as follows:

$$6.944\text{E}+3 \frac{\left[\frac{\text{mrem}}{\text{h}} \frac{100 \text{ cm}^2}{\text{dpm}} \right]}{\left[\frac{\text{Sv}}{\text{d}} \frac{\text{m}^2}{\text{Bq}} \right]} = \left[\frac{(100) 100 \text{ cm}^2}{\text{m}^2} \right] \left(\frac{1 \text{ Bq}}{\text{dps}} \right) \left(\frac{1 \text{ dps}}{60 \text{ dpm}} \right) \left(\frac{10^5 \text{ mrem}}{\text{Sv}} \right) \left(\frac{1 \text{ d}}{24 \text{ h}} \right) \quad (6.1)$$

$$4.167\text{E}+6 \frac{\left[\frac{\mu\text{Sv}}{\text{h}} \frac{100 \text{ cm}^2}{\text{Bq}} \right]}{\left[\frac{\text{Sv}}{\text{d}} \frac{\text{m}^2}{\text{Bq}} \right]} = \left(\frac{10^6 \mu\text{Sv}}{\text{Sv}} \right) \left(\frac{1 \text{ d}}{24 \text{ h}} \right) \left[\frac{(100) 100 \text{ cm}^2}{\text{m}^2} \right] \quad (6.2)$$

Parameter and Data Values

$$2.505E+8 \frac{\left[\frac{\text{mrem g}}{\text{h pCi}} \right]}{\left[\frac{\text{Sv m}^3}{\text{d Bq}} \right]} = \left(\frac{1.625E+6 \text{ g}}{\text{m}^3} \right) \left(\frac{0.037 \text{ Bq}}{\text{pCi}} \right) \left(\frac{10^5 \text{ mrem}}{\text{Sv}} \right) \left(\frac{1 \text{ d}}{24 \text{ h}} \right) \quad (6.3)$$

$$6.771E+10 \frac{\left[\frac{\mu\text{Sv g}}{\text{h}} \right]}{\left[\frac{\text{Sv m}^3}{\text{d}} \right]} = \left(\frac{1.625E+6 \text{ g}}{\text{m}^3} \right) \left(\frac{10^6 \mu\text{Sv}}{\text{Sv}} \right) \left(\frac{1 \text{ d}}{24 \text{ h}} \right) \quad (6.4)$$

The inhalation CEDE conversion factors for exposure to contaminated air are provided in units of mrem per pCi inhaled (and μSv per Bq inhaled).

Table 6.2 lists unit conversion factors used to convert the basic dose rate factors in the EPA data file to the desired units for this study.

Table 6.2 Unit conversion factors for inhalation dose factors

Units of EPA database parameter	Multiply by	To obtain value in units
Sv per Bq	3.700E+03	mrem per pCi inhaled
Sv per Bq	1.000E+06	μSv per Bq inhaled

The conversion factors of Table 6.2 are determined as follows:

$$3.700E+3 \frac{\left[\frac{\text{mrem}}{\text{pCi}} \right]}{\left[\frac{\text{Sv}}{\text{Bq}} \right]} = \left(\frac{10^5 \text{ mrem}}{\text{Sv}} \right) \left(\frac{0.037 \text{ Bq}}{\text{pCi}} \right) \quad (6.5)$$

$$1.000E+6 \left[\frac{\mu\text{Sv}}{\text{Sv}} \right] = \left(\frac{10^6 \mu\text{Sv}}{\text{Sv}} \right) \quad (6.6)$$

Ingestion of radionuclides can occur through several pathways, including ingestion of agricultural crops, ingestion of drinking water, and secondary ingestion of removable contamination in buildings. Secondary ingestion occurs when removable radioactive contamination found on facility surfaces is transferred from a surface to hands, foodstuffs, cigarettes, or other items that enter the mouth. Doses for ingestion pathways are estimated using ingestion CEDE conversion factors obtained from EPA Federal Guidance Report No. 11 (Eckerman, Wolbarst, and Richardson 1988), shown in Table E.2. These dose conversion factors are converted to units of mrem per pCi and μSv per Bq ingested, using

unit conversion factors given in Table 6.3. These unit conversion factors are used for the organ-specific dose factors (for the drinking water scenario), as well as for the CEDE factors.

Table 6.3 Unit conversion factors for ingestion dose factors

Units of starting database parameter	Multiply by	To obtain value in units
Sv per Bq	3.700E+03	mrem per pCi ingested
Sv per Bq	1.000E+06	μ Sv per Bq ingested

The conversion factors of Table 6.3 are determined in the same manner as described above in Equations (6.5) and (6.6) for the conversion factors of Table 6.2.

6.2.4 Dose Factors for Decay Chains

The basic internal and external dose factors used to calculate the annual TEDEs are taken directly from the dose factor files provided by ORNL. However, special consideration has been given to radioactive decay chains having short-lived progeny following a parent, or for cases in which equilibrium of progeny is assumed, as described in Section 6.1.1.

Radiations from short-lived progeny are assigned to the parent radionuclide immediately preceding the short-lived radionuclide. When short-lived progeny contributions are included, the dose factor for the parent is evaluated using the following expression:

$$DFC_i = DF_i + \sum_{j=1}^{N_d} DF_j F_j \quad (6.7)$$

where DFC_i = combined dose factor (internal or external) for the parent radionuclide i , in appropriate units for the dose factor type

DF_i = dose factor for the parent radionuclide as taken from the database, in appropriate units for the dose factor type

N_d = number of short-lived progeny for which contributions are to be included with the parent radionuclide dose factors, as defined by criteria of Section 6.1.1

j = index of short-lived progeny to be included

DF_j = dose factor for the short-lived radionuclide j , as taken from the database, in appropriate units for the dose factor type

F_j = the fraction of parent transitions that result in production of short-lived radionuclide j .

The progeny transition fractions, F_j , are provided in column 2 of Tables E.2 through E.5.

6.3 Media-Specific Considerations for Exposure Scenarios

The annual TEDEs produced by the scenario analysis are based on the dose rate and CEDE conversion factors described in Section 6.1 and pathway-specific assumptions and parameters, including exposure durations, quantities inhaled or ingested, and media concentrations. This section describes the media-specific considerations used to produce concentrations and doses for inhalation, secondary ingestion, ingestion of agricultural foods, and ingestion or agricultural use of ground water.

6.3.1 Air Concentrations for Inhalation

Evaluation of CEDE for inhalation is performed using equations of the following general form:

$$\begin{aligned} [\text{CEDE for Inhalation}] &= [\text{Exposure Duration for Scenario}] \\ &\times [\text{Volumetric Breathing Rate}] \\ &\times [\text{Airborne Dust-Loading}] \\ &\times [\text{Inhalation Dose Factor}] \\ &\times [\text{Mean Activity Level}]. \end{aligned} \tag{6.8}$$

The concentration of respirable dust in the air will vary depending upon a variety of factors, including the physical condition (such as the particle size) of the material being handled, the quantity of the material present, and the building ventilation or wind conditions. For this study, concentrations of respirable dust in the air are estimated using mass-loading factors and resuspension factors.

Perhaps the simplest method of estimating air concentrations is to use mass-loading factors. For this method, the average air concentration is defined in terms of g/m^3 of air. This concentration is converted to units of activity using the concentration of the source material. Although dust-loading in itself is not a topic that is widely studied or reported in the literature, topics related to dust-loading are reported, including concentrations of particles, aerosols, and total suspended particulates (TSP). The field of air pollution has the greatest amount of relevant literature, including representative entries in several leading reference books (MaGill, Holden, and Ackley 1956; Stern 1968; U.S. Department of Health, Education, and Welfare [HEW] 1969; Lillie 1970; and Hinton et al., 1986). In addition, health hazard evaluation reports listed in the *Energy Research Abstracts* sometimes contain data for indoor or outdoor concentrations of particles for specific industrial settings. Additional information can be found in the *Air Pollution Control Association Journal* for specific situations.

For indoor dust, 29 CFR 1910.1000 (1990) provides the regulatory limits authorized by the Occupational Safety and Health Administration (OSHA), Department of Labor. The 8-hour time-weighted-average (TWA) value allowed for dust ranges from 5 to 15 mg/m^3 . The value for total dust is 15 mg/m^3 , but is reduced to 10 mg/m^3 for certain compounds. The respirable fraction of dust is regulated at 5 mg/m^3 . Other dusts have specific concentration limits based on their harmful characteristics. Cadmium and crystalline quartz silica are the most restrictive, with limits of 0.02 and 0.05 mg/m^3 . Other dusts have limits up to 5 mg/m^3 . The American Conference of Governmental Industrial Hygienists

(ACGIH 1987) recommends threshold limit values (TLVs) of 10 mg/m^3 of total dust. This limit is for a "normal workday" and does not apply for short periods of exposure to high concentrations.

For this analysis, the radioactive concentrations in indoor air for the building renovation and residential scenarios have been assumed to be 10^{-4} and $5 \times 10^{-5} \text{ g/m}^3$, respectively. This range is a fraction of the maximum total dust limits, representing longer-term average concentrations and accounting for airborne dust from nonradioactive sources. This range provides a prudently conservative estimate of actual radioactive dust-loadings in the workplace or household, and serves as an adequate basis for the first-level generic screening analysis.

For outdoor air concentrations, a number of references provide information for a wide variety of situations. In *Air Pollution, Vol. I* (Stern 1968), measurements from the National Air Sampling Network for urban stations are summarized for the period 1957-1963. Chemical analysis for suspended particles (soot and ash) of 14,494 urban and 3,114 non-urban samples in the United States yielded a geometric mean of $98 \text{ } \mu\text{g/m}^3$, with a maximum of $1706 \text{ } \mu\text{g/m}^3$. Information in *Air Quality Criteria for Particulate Matter* (HEW 1969) indicated that

...average suspended particle mass concentrations range from about $10 \text{ } \mu\text{g/m}^3$ in remote nonurban areas to about $60 \text{ } \mu\text{g/m}^3$ near urban locations. In urban areas, averages range from $60 \text{ } \mu\text{g/m}^3$ to $220 \text{ } \mu\text{g/m}^3$, depending on the size of the city and its industrial activity.

The *Air Pollution Handbook* (MaGill, Holden, and Ackley 1956) reported that suspended particles in the atmosphere of a number of communities in the United States can range from $100 \text{ } \mu\text{g/m}^3$ to 1000 or $2000 \text{ } \mu\text{g/m}^3$. The London smog disaster of December 1952 had concentrations of soot and ash particles that were more than $4000 \text{ } \mu\text{g/m}^3$ for 6 days with a reported 4000-fold increase over the normal death rate during that period.

Measurements of suspended dust were made at the Bikini Atoll in an effort to determine potential inhalation exposures from plutonium-contaminated soil (Shinn, Homan, and Robinson 1989). Background dust concentrations of $21 \text{ } \mu\text{g/m}^3$ and sea spray concentrations of $34 \text{ } \mu\text{g/m}^3$ were measured. The highest suspended dust concentrations measured were for tilling a bare field and were $136 \text{ } \mu\text{g/m}^3$.

Upper and lower limits of airborne-soil mass-loadings as a function of particle size were estimated for the Hanford Site near Richland, Washington (Sehmel 1975; 1977a; 1984). The volume distributions were for wind erosion, without mechanical disturbance, for a semi-arid climate. For particle sizes less than $10 \text{ } \mu\text{m}$, the upper limit for mass-loading was estimated to be about $700 \text{ } \mu\text{g/m}^3$. For particle diameters, larger than $10 \text{ } \mu\text{m}$, the upper limit for mass-loading was $232,000 \text{ } \mu\text{g/m}^3$. The effect of mechanical disturbances is to create somewhat higher localized air concentrations than for wind erosion alone. For comparison, relatively clean air has a dust-loading of about $20 \text{ } \mu\text{g/m}^3$ (Sehmel 1977b); a dust-loading of $110,000 \text{ } \mu\text{g/m}^3$ is barely tolerable for breathing (Stewart 1964); and the dust concentration measured in a dust devil (whirlwind) is approximately 5 g/m^3 (Sinclair 1976).

Previous efforts have been made to determine a long-term average dust-loading for purposes of radiation dose assessment. A 1973 study assessed the potential environmental impacts of the interim storage of commercial high-level wastes in a retrievable surface storage (Soldat et al. 1973). This high-level waste assessment used an average atmospheric dust-loading of $100 \text{ } \mu\text{g/m}^3$ as being a typical annual average dust-loading. In 1975, Anspaugh et al. suggested the use of $100 \text{ } \mu\text{g/m}^3$ for predictive purposes. This value was partly based on measurements for 30 nonurban locations with arithmetic averages from 9 to $70 \text{ } \mu\text{g/m}^3$ (Anspaugh et al. 1975).

For the residential scenario, long-term average outdoor dust-loadings are assumed to be $1 \times 10^{-4} \text{ g/m}^3$ ($100 \text{ } \mu\text{g/m}^3$), consistent with the value selected by previous studies. Short-term gardening activities are likely to produce localized, elevated dust-loadings. To account for this possibility, the dust-loading for gardening is assumed to be $5 \times 10^{-4} \text{ g/m}^3$.

Parameter and Data Values

(500 $\mu\text{g}/\text{m}^3$). These dust-loadings are within the ranges established from literature sources and should result in a prudently conservative first-level generic screening analysis.

For the building occupancy scenario and indoor exposure to house dust in the residential scenario, the resuspension factor method is used. For this method, the average airborne concentration is a function of a resuspension factor and the surface contamination level, as follows:

$$c = S_f S_A \quad (6.9)$$

where c = average airborne concentration (pCi/m^3 or Bq/m^3)

S_f = resuspension factor (m^{-1})

S_A = activity per unit area (pCi/m^2 or Bq/m^2).

The typical ranges for reported resuspension factors, as shown in Table 6.4 is from about 10^{-11} to 10^{-4} m^{-1} .

To apply a resuspension factor analysis, there must be a reasonably uniform level of removable surface contamination, as would be found for soil contamination conditions. The IAEA suggested an indoor resuspension factor of $5 \times 10^{-5} \text{ m}^{-1}$ (IAEA 1970). This factor was intended to apply to operating nuclear facilities. Inside buildings after decontamination operations, it is unlikely that significant removable surface contamination would be present. This value is within the range of resuspension factors cited by Sehmel (1980) for activities conducted within rooms. For the building occupancy scenario of this study, a lower value of 10^{-6} is used because surfaces are assumed to be cleaned of easily removable contamination at the time of license termination. This value provides a prudently conservative basis for the generic analysis of the building occupancy scenario. For the residential scenario, the IAEA-suggested indoor resuspension factor value of $5 \times 10^{-5} \text{ m}^{-1}$ is used because the airborne material is largely soil tracked into the house.

For this analysis, the inhalation CEDEs are calculated using an assumed particle size distribution of 1- μm average median aerodynamic diameter (AMAD). A listing of the assumed inhalation classes that were selected to provide a prudently conservative estimate of the potential inhalation dose, as calculated using the ICRP lung model, is shown in Table E.6 of Appendix E. In most cases, the inhalation class selection will maximize the potential inhalation dose. For plutonium, the inhalation class selection represents the most common chemical form that will likely be encountered in environmental situations.

Local annual averaged dust-loadings may be higher or lower than the values assumed in this study, depending on soil and wind conditions.

6.3.2 Secondary Ingestion Rates

Ingestion of removable surface contamination inside buildings after transfer to hands, foods, or other items entering the mouth is referred to as secondary ingestion. This pathway can be of importance for beta-emitters and is included in the building renovation and building occupancy scenarios to provide a balanced set of pathways for evaluation. The ingestion CEDE conversion factors are used to evaluate secondary ingestion in the scenario analysis. The secondary ingestion doses for building renovation and building occupancy are described in Section 3. The equations for secondary ingestion are of the general form of Equation (6.10):

Table 6.4 Reported resuspension information

Condition, author, and reference	Resuspension factor range (m ⁻¹)	Comments
<u>Wind Stress</u>		
Stewart (1964)	2×10^{-11} to 8×10^{-9}	Bare soil, ⁹¹ Y aqueous chloride.
Stewart (1964)	9×10^{-8} to 1×10^{-7}	²¹⁰ Po as oxide.
Stewart (1964)	9×10^{-8} to 5×10^{-7}	U ₃ O ₈ .
Anspaugh et al. (1974)	1×10^{-4} to 1×10^{-9}	Time-dependent model for plutonium in soil.
Sehmel (1980)	9×10^{-11} to 3×10^{-4}	Literature review.
Shinn, Homan, and Hofmann (1986)	1.8×10^{-13} to 6.1×10^{-10}	Nevada Test Site, plutonium aerosols.
Garland and Pattenden (1990)	$< 2 \times 10^{-9}$ $< 5 \times 10^{-10}$	Nuclear weapon test debris: 13 years after deposition 22 years after deposition.
Garland and Pattenden (1990)	3.6×10^{-9} to 4.9×10^{-8}	Chernobyl ¹³⁷ Cs deposition: initial factor, reduce by 0.23 to 0.64 within the first year.
<u>Vegetation</u>		
Healy and Fuquay (1959)	2.9×10^{-8} to 6×10^{-7}	Fluorescent powder.
Stewart (1964)	3×10^{-8} to 5×10^{-5}	U ₃ O ₈ .
<u>Mechanical Disturbances</u>		
Stewart (1964)	1.5×10^{-6} to 3×10^{-4}	Plutonium.
Sehmel (1974)	4.8×10^{-5} to 1.1×10^{-2}	ZnS, per disturbance.
Sehmel (1977a)	1×10^{-5} to 2×10^{-4}	ZnS, per disturbance.
Sehmel (1980)	1×10^{-10} to 4×10^{-2}	Literature review.
<u>Indoor Buildings</u>		
IAEA (1970)	5×10^{-5}	Surface contamination.
Sehmel (1980)	1×10^{-6} to 2×10^{-2} 2×10^{-4} to 4×10^{-2} 2×10^{-5} to 1.5×10^{-2}	Walking. Vigorous sweeping. Fan.

$$\begin{aligned}
 [\text{CEDE for Ingestion}] &= [\text{Exposure Duration for Scenario}] \\
 &\times [\text{Effective Transfer Rate for Ingestion}] \\
 &\times [\text{Ingestion Dose Factor}] \\
 &\times [\text{Mean Volume Activity}].
 \end{aligned}
 \tag{6.10}$$

To estimate the secondary ingestion effective transfer rate, a literature survey was conducted. Previous dose evaluations for ingestion of loose surface contamination have been directed toward chronic occupational exposure situations (Dunster 1962; Gibson and Wrixon 1979; Healy 1971; Kennedy et al. 1981). Additional studies have been conducted in estimating the quantities of lead contamination that could be ingested by different age groups (Sayre et al. 1974; Lepow et al. 1975; Walter, Yankel, and Von Lindern 1980; Gallacher et al. 1984; LaGoy 1987). A summary of the referenced surface contamination ingestion data is given in Table 6.5. A review of previous work on secondary ingestion pathways indicates that no quantitative data for radioactive materials are available. Because of this lack of data, previous dose estimates for secondary ingestion have relied on assumed effective transfer rates. Quantitative data for ingestion of lead by children indicate that they may ingest 11 to 50 mg of lead from hand surfaces with a frequency of up to 10 times per day (Sayre et al. 1974; Lepow et al. 1975; Walter, Yankel, and Von Lindern 1980; Gallacher et al. 1984; LaGoy 1987). The total quantity ingested per day by children may range upward from about 0.1 g.

For our analysis, adult workers are assumed to ingest less removable contamination than children, and renovation workers are assumed to ingest at a higher rate than workers who have routine occupancy. To estimate the potential radiation doses resulting from secondary ingestion, adult renovation workers are assumed to ingest 10 mg of loose surface contamination per hour of exposure. Workers during routine building occupancy are assumed to ingest surface loose contamination at a lesser rate because of the general reduction of removable surface contamination in the building. The assumed secondary ingestion effective transfer rate for building occupancy is the loose surface contamination associated with an area of 10^{-4} m^2 per hour of exposure. These assumed values are within the range of values reported in the literature for secondary ingestion. In general, the most soluble form of each element was assumed to maximize the calculated ingestion dose, as shown by the assumed f_1 values in Table E.6 of Appendix E. These assumptions should form a conservative basis for the first-level generic screening analysis.

Evaluation of the dose from ingestion of soil for the residential scenario requires an estimate of the average daily intake of soil by an individual. Considerable uncertainty (and variability) exists in estimating values for soil intake. Also, most experiments designed to estimate effective transfer rates for soil ingestion have been directed toward children. Early estimates of soil ingestion rates were based largely on observations of mouthing behavior and measurements of soil on hands (LaGoy 1987). Calabrese and Stanek (1991) have recently reviewed and reported on attempts to estimate soil ingestion rates experimentally by measuring tracer metal concentrations in soil and feces. Table 6.6 lists effective transfer rates for soil ingestion reported in literature cited by Calabrese and Stanek (1991), plus other studies as identified in the table.

Calabrese and Stanek (1991) reviewed four major studies of soil ingestion rates (Binder, Sokal, and Maughan [1986], Calabrese et al. [1989], Davis et al. [1990], and Van Wijnen, Clausing, and Brunekreef [1990]). They concluded, based on an evaluation of experimental design and statistics related to tracer detection, that the quantitative results of the Binder and Van Wijnen studies were questionable. The other two studies were concluded to be of value and indicate that soil intake by children is generally less than 100 mg/d (except for children who exhibit unusual soil ingestion habits).

Table 6.5 Referenced surface-contamination ingestion data

Author and reference	Reported ingestion rate or other value	Comments
Dunster (1962)	10^{-3} m ² /d	Chronic ingestion of MPC _w values of ²²⁶ Ra, ⁹⁰ Sr, and ²¹⁰ Pb to derive permissible levels of skin contamination.
Gibson and Wrixon (1979)	10^{-3} m ² /d	Chronic ingestion. No data available to improve Dunster's model (MPC _w analysis).
Healy (1971)	10^{-4} m ² /h	Chronic ingestion during 8 h for workers, 24 h for members of the public. These are arbitrary assumptions in an effort to account for presumed higher intake by children-- 2.4×10^{-3} m ² /d.
Kennedy et al. (1981)	10^{-4} m ² /h	Chronic ingestion of removable surface contamination on transportation containers. Dose estimates for both workers and members of the public (2000 h/y exposure).
Sayre et al. (1974)	0.018 m ² of dust on hands (children)	Dirt-hand-mouth ingestion route by children for intake of lead dust. Measurement of the amount of lead dust on children's hands compared with the level present on surfaces in a house.
Lepow et al. (1975)	0.1 g/d (children)	"Hands-in-mouth" exposure route is the principal cause of excessive lead ingestion. Mean measured weight on children's hands was 11 mg. Assuming a mouthing frequency of 10 times/d for small children yields an estimate of 0.1 g of dirt ingested/d.
Walter, Yankel, and Von Lindern (1980)	Age-dependent	Secondary risk factors for lead ingestion were found to be age-dependent. Household dustiness is a factor for ages 2 years and under; soil lead is a factor for ages 2 to 7 years.
Gallacher et al. (1984)	10^{-3} to 3×10^{-3} m ² /h (children)	Data comparing environmental and hand contamination of lead on children's hands was equivalent by 20 to 50 mg. This level was estimated to equal about 1×10^{-3} to 3×10^{-3} m ² at the level present in outdoor areas.

The 1990 study by Calabrese et al. is the only reported study in which adult soil intake rates were measured (mean intake range was 5-77 mg/d depending on the tracer used in the evaluation). Based largely on this study and the belief that the adult soil ingestion rate would be less than that for small children (the age examined by most other studies), a soil ingestion rate of 50 mg/d (0.05 g/d) was selected as a reasonably conservative value for the residential scenario. This parameter selection should provide a prudently conservative basis for the first-level generic screening analysis.

Table 6.6 Referenced secondary soil ingestion rates

Author and reference	Reported ingestion rate (mg/d)	Age	Comments
National Academy of Science (1980)	day20	Adult	Suggested value for adults (estimated).
Lepow et al. (1975)	100	Child	Estimated from mouthing and measurements of soil on hands.
Hawley (1985)	66 30-160	Adult Child	Estimated values. Estimated values.
Binder, Sokal, and Maughan (1986)	130	Child	Arithmetic mean using tracers (Al and Si).
Calabrese et al. (1989)	9-40	Child	Median measured values using tracers (Al, Si, and Y) with food ingestion taken into account.
Davis et al. (1990)	39-82	Child	Mean measured values using tracers (Al and Si).
Calabrese et al. (1990)	5-77	Adult	Mean measured values using tracers (Al, Si, Y, and Zr) with food ingestion taken into account.
Van Wijnen, Clausing, and Brunekreef (1990)	0-90	Child	Geometric mean values using tracers (Al, Ti, and acid-insoluble residue) for children in daycare centers.
Van Wijnen, Clausing, and Brunekreef (1990)	30-200	Child	Geometric mean values using tracers (Al, Ti, and acid-insoluble residue) for children in campgrounds.
EPA (1991)	200 100	Child Adult	Values selected for use in exposure analyses for individuals in an agricultural setting.
EPA (1991)	50	Adult	Value selected for use in exposure analyses for individuals in an industrial setting.

6.4 Water-Use Model Data

This section discusses the parameter values selected for implementation of the three-box water-use model for the drinking water and residential scenarios.

Selection of 0.18 m/y as the infiltration rate determined for humid areas should provide a bounding assumption because many sites are located in areas of lower annual rainfall. This value was obtained from the waste management literature (Oztunali et al. 1981), and the same value is used for both scenarios. The application of irrigation water is relevant to arid areas and is necessary to supplement a lack of precipitation. The total infiltration for such areas is therefore expected to be approximately the same as for humid areas that do not involve irrigation. Also, selection of 0.3 as the porosity of the soil is intended to provide a bounding analysis. The irrigation rate is set to 76 cm/y (about 30 in./y) or 2.08 L/m²·d. This is a representative value sufficient to produce most crops.

The partition coefficients are used to develop the leach-rate constants between the surface-soil layer, the unsaturated-soil layer, and the aquifer. Sheppard and Thibault (1990) have suggested values for solid/liquid partition coefficients for several elements and for four types of soil: sand, loam, clay, and organic. Sand soil was characterized as mineral soils with >70% sand-sized particles. Clay soil was characterized as mineral soils with >35% clay-sized particles. Loam soils had approximately even distributions of sand-, clay-, and silt-sized particles, or consisted of up to 80% silt-sized particles. Soils with >30% organic matter were classified as organic soils and were either peat or muck soils, or the litter horizon of mineral soils. A set of partition coefficients was presented in Sheppard and Thibault (1990), based on either experimental values from the literature or derived from soil-to-plant concentration ratio data. For this study, experimental values are used, when available. The smallest partition coefficients (over all four types of soils) were selected, which represents the most mobile prediction. For the remainder of the elements, partition coefficients have been estimated from soil-to-plant concentration ratios as defined for leafy vegetables (essentially whole plant values), using the following correlation (Thibault, Sheppard, and Smith 1990) for sand soils:

$$\ln(Kd_{ki}) = 2.11 - 0.56 \ln(B_{iv}/4) \quad (6.11)$$

where Kd_{ki} = partition coefficient for radionuclide i in soil layer k (mL/g)

B_{iv} = concentration ratio for vegetative parts of the plant v (dry-weight basis) for radionuclide i

4 = factor for conversion of B_{iv} values from dry-weight to wet-weight basis.

The value for k is either 1 (for the surface-soil layer) or 2 (for the unsaturated-soil layer). The B_{iv} values were taken from the transfer factor database described in Section 6.5. It should be noted that the coefficient to the concentration ratio logarithm term (-0.56) is taken from Thibault, Sheppard, and Smith (1990) and was incorrectly printed as -0.5 in Sheppard and Thibault (1990).^(a)

The partition coefficients (Kd_{ki}) resulting from the above selection methods are listed in Table 6.7, which was prepared from computer-readable electronic files, anticipating their direct use in user-friendly software implementing the scenario/pathway analysis. It should also be noted that a single value for Kd_{ki} is defined for each element to be used for both soil layers for the first level of screening analysis.

The use of the simple three-box water-use model with these conservative default parameter values provides a conservative estimate of the potential concentrations that could be present in ground-water systems from residual radioactive contamination in soil. This approach is intentionally adopted to ensure that the first-level generic screening produces conservative results.

(a) Confirmed by personal communication with Dr. Marsha Sheppard by D. L. Strenge on May 19, 1992.

Parameter and Data Values

fraction parameters: x_f (fresh forage), x_h (stored hay), x_g (stored grain), and x_w (water). The default values for these feed fractions are set to 1.0, representing total intake being derived from contaminated sources.

The intake rate of soil by animals during grazing is quite variable and depends on seasonal factors and the behavior of specific animals. For cattle, the intake rate can vary from 1% to 18% of the dry-matter intake (data summarized by Thorton and Abrahams 1983), based on studies of grazing animals in Britain and New Zealand. One study reported by Fries (1982 and 1987), indicated that cattle in areas where grazing can occur during the entire year ingest about 6% of dry-matter intake as soil. Simmons, Linsley, and Jones (1979) suggest that soil can contribute 4% of the dry matter consumed by cows. Free-range poultry are expected to take in even more soil because of their need to supply sand to their gizzards. Thorne (1984) suggested a value of 10% of dry-matter intake be used for poultry, although no data are available to support that figure. Based on the above information and the suggestions of Thorne (1984), the default soil intake for cattle (beef and milk cows) is set to 5% of dry-matter intake. For poultry (poultry and egg hens), the intake value is set to 10% of dry-matter intake.

6.5.2 Plant Soil Mass-Loading Factor

The transfer of activity from soil to plants is represented by two pathways: root uptake and resuspension to plant surfaces. These pathways are included in equations of Section 5 through the concentration ratio, B_{pv} , and plant soil mass-loading factor, ML_v , respectively. The plant soil mass-loading factor measures the amount of soil on plants. Evaluation of the plant soil mass-loading factor is based on data from the literature for systems in which transfer is expected to be dominated by the resuspension pathway. (Concentration ratio values are presented in Section 6.5.9.) Note that the plant soil mass-loading factor is not a function of radionuclide because the controlling mechanism is assumed to be transfer of soil.

The dominant pathway depends mainly on the radionuclide and the ability of plants to take in the radionuclide via roots. For radionuclides that are easily taken in via roots, the root uptake pathway will dominate and the concentration ratio value will control the transfer from soil to plant. For radionuclides that are not readily taken in by plant roots (e.g., radionuclides that are bound to the soil), the resuspension pathway will dominate and the plant soil mass-loading factor will control the transfer from soil to plant.

Citing data from monitoring studies at the Nevada Test Site, Martin and Bloom (1980) suggest that 99% of the transfer of plutonium from soil to plants occurs via the resuspension route. Pinder et al. (1990) also found that plutonium resuspension was about an order of magnitude more important for transfer from soil to corn grains at the Savannah River Site. Estimation of plant concentrations for cases where resuspension dominates can be represented as follows:

$$C_{vi} = C_{si} ML_v \quad (6.13)$$

where C_{vi} = concentration of parent radionuclide i in food crop v in equilibrium with activity in soil (pCi/g dry plant)

C_{si} = concentration of parent radionuclide i in soil (pCi/g dry soil)

ML_v = plant mass-loading factor for plant type v (g dry soil/g dry plant).

The appropriate value for the plant soil mass-loading factor, as applied in Equation (6.13), includes consideration of translocation of activity in soil from plant surfaces to edible parts of the plant.

Martin and Bloom (1980) suggest that the estimation of activity on plants can be described by an effective concentration ratio that includes both routes of transfer. This approach can also be represented by Equation (6.13) if the mass-loading factor is replaced by the effective concentration ratio, as follows:

$$C_{vi} = C_{si} CR_v \quad (6.14)$$

where CR_v is the effective concentration ratio for transfer of material from soil to plants (pCi/g dry plant per pCi/g dry soil).

The effective concentration ratio and the plant mass-loading factor are equivalent for systems in which resuspension dominates the transfer from soil to plants. Table 6.9 provides a summary of reported values for the plant soil mass-loading factor, and Table 6.10 summarizes data on effective concentration ratios. The values presented show a considerable variation, ranging between a low of 0.0011 and a high of 0.26. A default value for the plant soil mass-loading factor of 0.1 is selected. Even though this value is more than a factor of two less than the highest reported values, it is believed to represent a prudently conservative estimate of resuspension transfer from soil to edible parts of plants. The reported values of plant soil mass-loading represent soil adhered to plant surfaces, and do not necessarily include the translocation of activity to edible parts of plants. Therefore, selection of a default value less than the maximum values is appropriate.

A review of concentration ratio values for elements of interest in the present study (Section 6.5.9) indicates that several radionuclides have reported values greater than the effective concentration ratios and plant mass-loading factors given in Tables 6.9 and 6.10. This suggests that the effective concentration ratio method (using data cited in the two tables) should not be based solely on plant mass-loading factors. In keeping with the desire to provide a prudently conservative analysis, the radionuclide concentration in edible parts of plants is evaluated as the sum of contributions from root uptake and resuspension: the pathways are not lumped into one effective concentration ratio. The summation over the two pathways is indicated in Equation (5.5) (and other equations of Section 5) as the sum of ML_v and B_{jv} .

6.5.3 Holdup Times

The time between harvest and consumption of each food product is based on values suggested by the NRC (1977) for a maximally exposed individual for food crops and beef. A nominal minimum time of 1 day is assigned to the other animal products, as indicated in Table 6.11.

6.5.4 Exposure Period/Animal Feeding Times

Because the animal products are assumed to be harvested continuously, the animal feeding is made to coincide (in length) with the human consumption period. Also, the residential scenario is to provide the dose for a 1-year period. For these reasons, the animal feeding times and human consumption periods are set to 1 year (365.25 days) for all food products.

6.5.5 Crop-Growing Periods

The growing periods for food crops and animal-fed crops are based on suggestions by Soldat and Harr (1971), Kennedy et al. (1987), and Napier et al. (1988). The values used for the crop-growing periods are given in Table 6.12. These values represent the time to produce one crop and may not be the same as the growing season, during which multiple crops may be harvested.

Table 6.9 Summary of plant mass-loading data*

Plant conditions	Reported values (g soil/g dry plant)	References
Bush beans	0.03 - 0.06	White, Hakonson, and Ahlquist (1981)
Squash (<2 m above soil)	0.14 - 0.26	White, Hakonson, and Ahlquist (1981)
Squash (>2 m above soil)	0.03 - 0.04	White, Hakonson, and Ahlquist (1981)
Broccoli	0.01	McLeod, Pinder, and Watts (1984)
Cabbage	0.0011	McLeod, Pinder, and Watts (1984)
Lettuce	0.26	McLeod, Pinder, and Watts (1984)
Turnips	0.032	McLeod, Pinder, and Watts (1984)
Sunflowers	0.0026	Pinder and McLeod (1988)
Tobacco	0.0021	McLeod et al. (1984)
Tomato plants	0.017	Dreicer et al. (1984)
Meadow vegetation	0.018 (mean) 0.25 (max)	Arthur and Alldredge (1982)
English pastures	0.07	Green and Dodd (1988)
English pastures	0.05 - 0.20	Sumerling, Dodd, and Green (1984)

*Data cited by Pinder and McLeod (1989)

Table 6.10 Summary of effective concentration ratio data

Radionuclide	Reported values	Units	References
^{241}Am	0.23, 0.19	g soil/g plant	Gilbert, Engel, and Anspaugh (1989)
$^{239}\text{Pu} + ^{240}\text{Pu}$	0.17, 0.18	g soil/g plant	Gilbert, Engel, and Anspaugh (1989)
^{137}Cs	0.15	g soil/g plant	Gilbert, Engel, and Anspaugh (1989)
Plutonium	0.1	g soil/g plant	Martin and Bloom (1980)

6.5.6 Translocation Fraction from Leaves to Edible Parts

The translocation fraction is the fraction of activity deposited on plant surfaces that reaches the edible parts of the plant. The values used are those recommended by the NRC (1977) and Napier et al. (1988). A value of 1.0 is used for leafy vegetables, grasses, and hay, and a factor of 0.1 is used for other plant types.

Table 6.11 Holdup time for food consumption*

Food product	Holdup time (d)
Leafy vegetables	1
Other vegetables	14
Fruit	14
Grains	14
Beef	20
Poultry	1
Milk	1
Eggs	1

*Based on information in Soldat and Harr (1971) and NRC (1977).

Table 6.12 Minimum crop-growing periods*

Crop type	period (d)
Leafy vegetables	45
Other vegetables	90
Fruit	90
Grains	90
Beef: forage	30
stored hay	45
stored grain	90
Poultry: forage	30
stored hay	45
stored grain	90
Milk cows: forage	30
stored hay	45
stored grain	90
Eggs: forage	30
stored hay	45
stored grain	90

*Based on information in Soldat and Harr (1971), Kennedy et al. (1987), and Napier et al. (1988).

6.5.7 Crop Yields

Values for crop yields are adapted from Shor, Baes, and Sharp (1982); Strenge, Bander, and Soldat (1987); and Napier et al. (1988). The animal feed crop yields are defined by standing biomass for estimation of interception fraction and for the plant concentration calculation. The recommended crop yield values for animal products are provided in Table 6.13, and crop yield values for food crops are given in Table 6.14.

Table 6.13 Crop yields for animal products (kg wet weight/m²)*

Crop type	Beef	Poultry	Milk	Eggs
Fresh forage	1.5	1.0	1.5	1.0
Stored hay	1.0	1.0	1.0	1.0
Stored feed	1.0	1.0	1.0	1.0

*Based on information in Shor, Baes, and Sharp (1982), Strenge, Bander, and Soldat (1987), and Napier et al. (1988).

Table 6.14 Crop yields for food crops (kg wet weight/m²)*

Food crop	Yield
Leafy vegetables	2.0
Other vegetables	4.0
Fruit	2.0
Grains	1.0

*Based on information in Shor, Baes, and Sharp (1982), Strenge, Bander, and Soldat (1987), and Napier et al. (1988).

6.5.8 Consumption and Intake Parameters for Humans

The internal dose received by an individual for a particular pathway is directly proportional to the amount of the contaminated medium taken in by the individual. Inhalation dose is dependent on the volumetric breathing rate, and ingestion dose is dependent on the rate of intake of food products and water.

Ingestion of drinking water is evaluated for a daily intake rate of 2 L/d, as suggested by the EPA (1989). This value represents the 90th percentile daily drinking water ingestion rate as tap water, including uses in cooking and for beverages prepared using tap water (coffee, tea, etc.). Use of this value provides a conservative basis for the first-level generic screening analysis.

The intake rates for food products defined for the agricultural pathways are based on data collected during the Nationwide Food Consumption Survey (Pao et al. 1985; U.S. Department of Agriculture 1983). This study involved the collection of 3-day food intake data for about 36,000 individuals in the 48 contiguous states. The data were collected over a period of 1 year (April 1977 through March 1978) and are, therefore, representative of average intakes and include seasonal variations of intake for the food categories. The Nationwide Food Consumption Survey identified several hundred classes of food, selected to include the major types of food in the diet of the general population. Higley and Strenge (1988) condensed the data to 18 food groups and reported mean and median intake values for each group. The present analysis used mean values from these 18 food groups, supplemented by data from Pao et al. (1985), to obtain the mean daily ingestion rates for the eight food groups used in this study. The eight food groups were selected to be representative of food products that would be produced on a farm for home consumption and, therefore, do not include foods such as fish, oils, and sugars. Higley and Strenge (1988) reported only one value for vegetables, rather than the desired breakdown by leafy and other vegetables. The Pao et al. (1985) data were reviewed to determine the leafy vegetable mean intake rate, which was then subtracted from the Higley and Strenge (1988) vegetable value to obtain the "other" vegetable intake rate. The daily ingestion rates for the eight food products are given in Table 6.15.

6.5.9 Agricultural Pathway Transfer Factors

The transfer factor database contains several parameters defined for each element that are used in the agricultural pathway models, plus a partition coefficient that is used in the ground-water analysis. The transfer factors include the

Table 6.15 Daily ingestion rates for foods

Food type	Individual annual consumption rate	Units
Leafy vegetables	11	kg/y
Other vegetables	51	kg/y
Fruit	46	kg/y
Grain	69	kg/y
Beef	59	kg/y
Poultry	9	kg/y
Milk	100	L/y
Eggs	10	kg/y

soil-to-plant concentration factor for each food crop (leafy vegetables, other vegetables, fruit, and grain) and the animal product transfer factors (beef meat, poultry meat, cow milk, and chicken eggs).

The selection of values for the soil-to-plant concentration factors was based on the following hierarchy. The primary reference was the compilation of the International Union of Radioecologists (IUR 1989). For parameter values not defined in that report, the compilation of Baes et al. (1984b) was used. Finally, for californium (not included in Baes et al. 1984b), the values were taken from Strenge, Bander, and Soldat (1987). Table 6.16 gives the values for

Table 6.16 Soil-to-plant concentration factors

Element/atomic number	Soil-to-plant concentration factors (pCi/kg dry weight per pCi/kg soil)			
	Leafy vegetables	Root vegetables	Fruit	Grain
H 1	(-)*	(-)*	(-)*	(-)*
Be 4	1.0E-2	1.5E-3	1.5E-3	1.5E-3
C 6	7.0E-1	7.0E-1	7.0E-1	7.0E-1
N 7	3.0E+1	3.0E+1	3.0E+1	3.0E+1
F 9	6.0E-2	6.0E-3	6.0E-3	6.0E-3
Na 11	7.5E-2	5.5E-2	5.5E-2	5.5E-2
Mg 12	1.0E+0	5.5E-1	5.5E-1	5.5E-1
Si 14	3.5E-1	7.0E-2	7.0E-2	7.0E-2
P 15	3.5E+0	3.5E+0	3.5E+0	3.5E+0
S 16	1.5E+0	1.5E+0	1.5E+0	1.5E+0
Cl 17	7.0E+1	7.0E+1	7.0E+1	7.0E+1
Ar 18	(-)**	(-)**	(-)**	(-)**
K 19	1.0E+0	5.5E-1	5.5E-1	5.5E-1
Ca 20	3.5E+0	3.5E-1	3.5E-1	3.5E-1
Sc 21	6.0E-3	1.0E-3	1.0E-3	1.0E-3
Cr 24	7.5E-3	4.5E-3	4.5E-3	4.5E-3
Mn 25	5.6E-1	1.5E-1	5.0E-2	2.9E-1
Fe 26	4.0E-3	1.0E-3	1.0E-3	1.0E-3
Co 27	8.1E-2	4.0E-2	7.0E-3	3.7E-3
Ni 28	2.8E-1	6.0E-2	6.0E-2	3.0E-2
Cu 29	4.0E-1	2.5E-1	2.5E-1	2.5E-1
Zn 30	1.4E+0	5.9E-1	9.0E-1	1.3E+0
Ga 31	4.0E-3	4.0E-4	4.0E-4	4.0E-4
As 33	4.0E-2	6.0E-3	6.0E-3	6.0E-3
Se 34	2.5E-2	2.5E-2	2.5E-2	2.5E-2
Br 35	1.5E+0	1.5E+0	1.5E+0	1.5E+0
Kr 36	(-)**	(-)**	(-)**	(-)**
Rb 37	1.5E-1	7.0E-2	7.0E-2	7.0E-2
Sr 38	1.6E+0	8.1E-1	1.7E-1	1.3E-1
Y 39	1.5E-2	6.0E-3	6.0E-3	6.0E-3
Zr 40	2.0E-3	5.0E-4	5.0E-4	5.0E-4
Nb 41	2.0E-2	5.0E-3	5.0E-3	5.0E-3
Mo 42	2.5E-1	6.0E-2	6.0E-2	6.0E-2
Tc 43	4.4E+1	1.1E+0	1.5E+0	7.3E-1

Table 6.16 Soil-to-plant concentration factors (Continued)

Element/atomic number	Soil-to-plant concentration factors (pCi/kg dry weight per pCi/kg soil)			
	Leafy vegetables	Root vegetables	Fruit	Grain
Ru 44	5.2E-1	2.0E-2	2.0E-2	5.0E-3
Rh 45	1.5E-1	4.0E-2	4.0E-2	4.0E-2
Pd 46	1.5E-1	4.0E-2	4.0E-2	4.0E-2
Ag 47	2.7E-4	1.3E-3	8.0E-4	1.0E-1
Cd 48	5.5E-1	1.5E-1	1.5E-1	1.5E-1
In 49	4.0E-3	4.0E-4	4.0E-4	4.0E-4
Sn 50	3.0E-2	6.0E-3	6.0E-3	6.0E-3
Sb 51	1.3E-4	5.6E-4	8.0E-5	3.0E-2
Te 52	2.5E-2	4.0E-3	4.0E-3	4.0E-3
I 53	3.4E-3	5.0E-2	5.0E-2	5.0E-2
Xe 54	(-)**	(-)**	(-)**	(-)**
Cs 55	1.3E-1	4.9E-2	2.2E-1	2.6E-2
Ba 56	1.5E-1	1.5E-2	1.5E-2	1.5E-2
La 57	5.7E-4	6.4E-4	4.0E-3	4.0E-3
Ce 58	1.0E-2	4.0E-3	4.0E-3	4.0E-3
Pr 59	1.0E-2	4.0E-3	4.0E-3	4.0E-3
Nd 60	1.0E-2	4.0E-3	4.0E-3	4.0E-3
Pm 61	1.0E-2	4.0E-3	4.0E-3	4.0E-3
Sm 62	1.0E-2	4.0E-3	4.0E-3	4.0E-3
Eu 63	1.0E-2	4.0E-3	4.0E-3	4.0E-3
Gd 64	1.0E-2	4.0E-3	4.0E-3	4.0E-3
Tb 65	1.0E-2	4.0E-3	4.0E-3	4.0E-3
Dy 66	1.0E-2	4.0E-3	4.0E-3	4.0E-3
Ho 67	1.0E-2	4.0E-3	4.0E-3	4.0E-3
Er 68	1.0E-2	4.0E-3	4.0E-3	4.0E-3
Hf 72	3.5E-3	8.5E-4	8.5E-4	8.5E-4
Ta 73	1.0E-2	2.5E-3	2.5E-3	2.5E-3
W 74	4.5E-2	1.0E-2	1.0E-2	1.0E-2
Re 75	1.5E+0	3.5E-1	3.5E-1	3.5E-1
Os 76	1.5E-2	3.5E-3	3.5E-3	3.5E-3
Ir 77	5.5E-2	1.5E-2	1.5E-2	1.5E-2
Au 79	4.0E-1	1.0E-1	1.0E-1	1.0E-1
Hg 80	9.0E-1	2.0E-1	2.0E-1	2.0E-1
Tl 81	4.0E-3	4.0E-4	4.0E-4	4.0E-4
Pb 82	5.8E-3	3.2E-3	9.0E-3	4.7E-3
Bi 83	3.5E-2	5.0E-3	5.0E-3	5.0E-3
Po 84	2.5E-3	9.0E-3	4.0E-4	4.0E-4
Rn 86	(-)**	(-)**	(-)**	(-)**
Ra 88	7.5E-2	3.2E-3	6.1E-3	1.2E-3
Ac 89	3.5E-3	3.5E-4	3.5E-4	3.5E-4
Th 90	6.6E-3	1.2E-4	8.5E-5	3.4E-5
Pa 91	2.5E-3	2.5E-4	2.5E-4	2.5E-4

Table 6.16 Soil-to-plant concentration factors (Continued)

Element/atomic number	Soil-to-plant concentration factors (pCi/kg dry weight per pCi/kg soil)			
	Leafy vegetables	Root vegetables	Fruit	Grain
U 92	1.7E-2	1.4E-2	4.0E-3	1.3E-3
Np 93	1.3E-2	9.4E-3	1.0E-2	2.7E-3
Pu 94	3.9E-4	2.0E-4	4.5E-5	2.6E-5
Am 95	5.8E-4	4.1E-4	2.5E-4	5.9E-5
Cm 96	3.0E-4	2.4E-4	1.5E-5	2.1E-5
Cf 98	1.0E-2	1.0E-2	1.0E-2	1.0E-2

* Concentration factors for ^3H are not needed because a special model is used to determine ^3H uptake in plants.

** Noble gas radionuclides are not assumed to be taken up by plants.

soil-to-plant concentration factors used in the present analysis. All soil-to-plant concentration factors are based on unit dry weight of plant. The IUR report (1989) provided values for several plant types. The values were combined by the food crop and animal feed crop types defined for the present study (Table 6.12). The values were combined using a weighted geometric mean formula, with the weights being the number of observation data values for each data value in the IUR report. The compilation by Baes et al. (1984a) provided soil-to-plant concentration factors for vegetative parts and for reproductive parts of the plant. The values for vegetative parts were used for leafy vegetables, forage, and hay, and the values for reproductive parts were used for other vegetables, fruit, grain, and stored animal feed (other than hay).

The soil-to-plant concentration factors are defined in terms of dry weight of plants, but are converted to wet weight values for use in the agricultural models. The dry-to-wet-weight conversion factors given in Table 6.17 are from Till and Meyer (1983). These values apply to the edible parts of plants and may differ from the whole-plant values used in the interception fraction calculation (Section 6.5.2).

The primary source of animal product transfer factors was Napier et al. (1988). Additional values were found in Baes et al. (1984b) for beef and milk. Values for poultry and eggs were difficult to obtain and came primarily from Napier et al. (1988), who took them largely from Ng, Colsher, and Thompson (1982). However, there were several elements for which no information was available. For these elements, transfer factors for poultry and eggs were calculated from data for similar elements in the periodic chart. Values for transfer factors used for the present analysis are given in Table 6.18.

The deposition of contaminated irrigation water on plant surfaces may result in contamination of plants used for food and animal feed. The fraction of deposited activity that is retained on plant surfaces is given by the interception fraction. A value of 0.25 is used for all plant types as recommended by the NRC (1977).

Table 6.17 Dry-to-wet-weight conversion factors

Plant type	Conversion factor	
Leafy vegetables	0.2	
Other vegetables	0.25	
Fruit	0.18	
Grain	0.91	
Beef	Forage	0.22
	Stored hay	0.22
	Stored grain	0.91
Poultry	Forage	0.22
	Stored hay	0.22
	Stored grain	0.91
Milk	Forage	0.22
	Stored hay	0.22
	Stored grain	0.91
Eggs	Forage	0.22
	Stored hay	0.22
	Stored grain	0.91

6.6 Aquatic Food Pathway Data

Evaluation of dose from the aquatic food pathway requires definition of the consumption rate of aquatic foods, the volume of the surface-water pond, and the bioaccumulation factors for transfer of activity from water to edible parts of fish for elements of interest.

The consumption rate of aquatic foods is expressed as the mass of fish consumed during 1 year of the residential scenario. The EPA (1989) has published a value of 2.37 kg/y (6.5 g/d) for use in exposure assessments for the general population, with intake being from recreational and commercial harvests of marine and freshwater finfish and shellfish. Rupp, Miller, and Baes (1980) summarized consumption rates of fish by region in the United States and also provided U.S. averages. They reported that over 85% of the population eat no freshwater fish. They further report that the U.S. freshwater fish consumption rate is 1.87 kg/y at the 90th percentile; 8.39 at the 99th percentile; and 57.68 as a maximum observed value. The highest 90th percentile value reported was 2.63 kg/y for the West South Central region (Arkansas, Louisiana, Oklahoma, and Texas), and the highest 99th percentile value was 10.03 for the East South Central region (Alabama, Kentucky, Mississippi, and Tennessee). These percentiles are based on the entire population, including those individuals who eat no fish. Because the current scenario involves a resident who is assumed to eat freshwater fish from an available supply, a prudently conservative estimate of annual intake is selected as the 99th percentile value for the highest regional rate, which is 10 kg/y. This represents approximately the 93rd percentile for those individuals who eat freshwater fish within the region.

The volume of the surface-water pond is selected to represent the volume of water necessary to raise enough fish to provide the annual consumption for one individual. Water requirements for raising fish depend on the type of fish and the aquaculture practices used by the resident. For example, if the fish are left to eat natural foods in the pond, a large volume of water will be needed to sustain the food necessary for the fish throughout the entire food chain. On the

Table 6.18 Animal product transfer factors

Element	Animal product transfer factors, wet-weight basis			
	Beef (d/kg)	Poultry (d/kg)	Milk (d/L)	Eggs (d/kg)
H 1	(-)**	(-)**	(-)**	(-)**
Be 4	1.0E-3	4.0E-1	9.0E-7	2.0E-2
C 6	(-)**	(-)**	(-)**	(-)**
N 7	7.5E-2	1.0E-1*	2.5E-2	8.0E-1*
F 9	1.5E-1	1.0E-2*	1.0E-3	2.0E+0*
Na 11	5.5E-2	1.0E-2	3.5E-2	2.0E-1
Mg 12	5.0E-3	3.0E-2*	4.0E-3	1.6E+0
Si 14	4.0E-5	2.0E-1*	2.0E-5	8.0E-1*
P 15	5.5E-2	1.9E-1	1.5E-2	1.0E+1
S 16	1.0E-1	9.0E-1*	1.5E-2	7.0E+0*
Cl 17	8.0E-2	3.0E-2	1.5E-2	2.0E+0*
Ar 18	(-)**	(-)**	(-)**	(-)**
K 19	2.0E-2	4.0E-1*	7.0E-3	7.0E-1*
Ca 20	7.0E-4	4.4E-2	1.0E-2	4.4E-1
Sc 21	1.5E-2	4.0E-3	5.0E-6	3.0E-3*
Cr 24	5.5E-3	2.0E-1*	1.5E-3	8.0E-1*
Mn 25	4.0E-4	5.0E-2	3.5E-4	6.5E-2
Fe 26	2.0E-2	1.5E+0	2.5E-4	1.3E+0
Co 27	2.0E-2	5.0E-1	2.0E-3	1.0E-1
Ni 28	6.0E-3	1.0E-3	1.0E-3	1.0E-1
Cu 29	1.0E-2	5.1E-1	1.5E-3	4.9E-1
Zn 30	1.0E-1	6.5E+0	1.0E-2	2.6E+0
Ga 31	5.0E-4	3.0E-1*	5.0E-5	8.0E-1*
As 33	2.0E-3	8.3E-1	6.0E-5	8.0E-1*
Se 34	1.5E-2	8.5E+0	4.0E-3	9.3E+0
Br 35	2.5E-2	4.0E-3	2.0E-2	1.6E+0
Kr 36	(-)**	(-)**	(-)**	(-)**
Rb 37	1.5E-2	2.0E+0	1.0E-2	3.0E+0
Sr 38	3.0E-4	3.5E-2	1.5E-3	3.0E-1
Y 39	3.0E-4	1.0E-2	2.0E-5	2.0E-3
Zr 40	5.5E-3	6.4E-5	3.0E-5	1.9E-4
Nb 41	2.5E-1	3.1E-4	2.0E-2	1.3E-3
Mo 42	6.0E-3	1.9E-1	1.5E-3	7.8E-1
Tc 43	8.5E-3	3.0E-2	1.0E-2	3.0E+0
Ru 44	2.0E-3	7.0E-3	6.0E-7	6.0E-3
Rh 45	2.0E-3	5.0E-1*	1.0E-2	1.0E-1*
Pd 46	4.0E-3	3.0E-4	1.0E-2	4.0E-3
Ag 47	3.0E-3	5.0E-1*	2.0E-2	5.0E-1*
Cd 48	5.5E-4	8.4E-1	1.0E-3	1.0E-1
In 49	8.0E-3	3.0E-1*	1.0E-4	8.0E-1*

Table 6.18 Animal product transfer factors (Continued)

Element	Animal product transfer factors, wet-weight basis			
	Beef (d/kg)	Poultry (d/kg)	Milk (d/L)	Eggs (d/kg)
Sn 50	8.0E-2	2.0E-1*	1.0E-3	8.0E-1*
Sb 51	1.0E-3	6.0E-3	1.0E-4	7.0E-2
Te 52	1.5E-2	8.5E-2	2.0E-4	5.2E+0
I 53	7.0E-3	1.8E-2	1.0E-2	2.8E+0
Xe 54	(-) ^{***}	(-) ^{***}	(-) ^{***}	(-) ^{***}
Cs 55	2.0E-2	4.4E+0	7.0E-3	4.9E-1
Ba 56	1.5E-4	8.1E-4	3.5E-4	1.5E+0
La 57	3.0E-4	1.0E-1	2.0E-5	9.0E-3
Ce 58	7.5E-4	1.0E-2	2.0E-5	5.0E-3
Pr 59	3.0E-4	3.0E-2	2.0E-5	5.0E-3
Nd 60	3.0E-4	4.0E-3	2.0E-5	2.0E-4
Pm 61	5.0E-3	2.0E-3	2.0E-5	2.0E-2
Sm 62	5.0E-3	4.0E-3	2.0E-5	7.0E-3
Eu 63	5.0E-3	4.0E-3	2.0E-5	7.0E-3
Gd 64	3.5E-3	4.0E-3*	2.0E-5	7.0E-3*
Tb 65	4.5E-3	4.0E-3	2.0E-5	7.0E-3
Dy 66	5.5E-3	4.0E-3*	2.0E-5	7.0E-3*
Ho 67	4.5E-3	4.0E-3	2.0E-5	7.0E-3
Er 68	4.0E-3	4.0E-3*	2.0E-5	7.0E-3*
Hf 72	1.0E-3	6.0E-5*	5.0E-6	2.0E-4*
Ta 73	6.0E-4	3.0E-4*	3.0E-6	1.0E-3*
W 74	4.5E-2	2.0E-1*	3.0E-4	8.0E-1*
Re 75	8.0E-3	4.0E-2*	1.5E-3	4.0E-1*
Os 76	4.0E-1	1.0E-1*	5.0E-3	9.0E-2*
Ir 77	1.5E-3	5.0E-1*	2.0E-6	1.0E-1*
Au 79	8.0E-3	5.0E-1*	5.5E-6	5.0E-1*
Hg 80	2.5E-1	1.1E-2	4.5E-4	2.0E-1*
Tl 81	4.0E-2	3.0E-1*	2.0E-3	8.0E-1*
Pb 82	3.0E-4	2.0E-1*	2.5E-4	8.0E-1*
Bi 83	4.0E-4	1.0E-1*	5.0E-4	8.0E-1*
Po 84	3.0E-4	9.0E-1*	3.5E-4	7.0E+0*
Rn 86	(-) ^{***}	(-) ^{***}	(-) ^{***}	(-) ^{***}
Ra 88	2.5E-4	3.0E-2*	4.5E-4	2.0E-5
Ac 89	2.5E-5	4.0E-3	2.0E-5	2.0E-3
Th 90	6.0E-6	4.0E-3	5.0E-6	2.0E-3
Pa 91	1.0E-5	4.0E-3	5.0E-6	2.0E-3
U 92	2.0E-4	1.2E+0	6.0E-4	9.9E-1
Np 93	5.5E-5	4.0E-3	5.0E-6	2.0E-3
Pu 94	5.0E-7	1.5E-4	1.0E-7	8.0E-3
Am 95	3.5E-6	2.0E-4	4.0E-7	9.0E-3

Table 6.18 Animal product transfer factors (Continued)

Element	Animal product transfer factors, wet-weight basis			
	Beef (d/kg)	Poultry (d/kg)	Milk (d/L)	Eggs (d/kg)
Cm 96	3.5E-6	4.0E-3	2.0E-5	2.0E-3
Cf 98	5.0E-3	4.0E-3	7.5E-7	2.0E-3

- * Transfer factors derived from data for similar elements.
- ** Transfer factors for ^3H and ^{14}C are not needed because special models for transfer in animals are used for these two radionuclides.
- *** Noble gases are assumed not to be transferred to animal products.

other hand, if the resident feeds the fish supplemental food, the water volume requirement will be much less. Data provided by Bardach, Ryther, and McLarney (1972) indicate that the mean production rate of catfish for pond culture is about 2600 kg/y per ha of pond area. This should be considered to be a maximum production rate involving a commercial operation using large ponds, with the production representing total fish weight. The area of pond needed to produce the annual ingestion amount of 10 kg/y (edible) can be estimated as follows:

$$\text{Pond Area} = (10 \text{ kg/y}) / [(0.6 \text{ edible fraction}) (2600 \text{ kg/y/ha})] = 0.0064 \text{ ha} \quad (6.15)$$

or 64 m², where the edible fraction of catfish is taken to be a nominal value of 0.6 (Bardach, Ryther, and McLarney 1972). This area represents a very small pond in which the fish are provided their feeding requirements. No information is available on fish production rates in farm pond systems in which the fish are totally dependent on aquatic biota produced within the pond ecosystem. For the present analysis, the pond is taken to be 10 times the minimum pond size for cultured ponds, with a water depth assumed to be 2 m. This pond depth will provide protection for aquatic species from temperature extremes plus allow light penetration needed to support the ecosystem. With these assumptions, the volume of water needed for production of the annual fish consumption amount is 1300 m³ or 1.3 x 10⁶ L.

The transfer of activity from water to edible parts of fish is based on bioaccumulation factors defined for each element of interest. The bioaccumulation factor is the ratio of radionuclide concentration in fish to the radionuclide concentration in water. Table 6.19 lists the default values for bioaccumulation factors. The primary reference for these values is a compilation of recommended freshwater fish bioaccumulation factors by Poston and Klopfer (1988), supplemented by data from Streng, Peloquin, and Wehlan (1986). The latter reference contains bioaccumulation factors for freshwater fish as used in the NRC computer program LADTAP II in support of NRC Regulatory Guide 1.109 (NRC 1977).

6.7 Summary of Parameters That May Vary and Default Value Assignments

The mathematical formulations contained in Sections 2 through 5 of this report contain numerous parameters that have been identified for each exposure scenario and pathway. Most of these parameters can have a significant range, and the selection of specific values is an important part of the generic evaluation of radiation doses from residual radioactive material. This section summarizes by scenario the model parameters that may vary and provides the assigned default values. The default values are used to generate the first-level screening unit concentration annual

Fish Fish
↓

Table 6.19 Fish bioaccumulation factors (BA_f) for the residential scenario

<u>Bioaccumulation</u>			<u>Bioaccumulation</u>		
<u>Element</u>	<u>Factor</u>	<u>Basis*</u>	<u>Element</u>	<u>Factor</u>	<u>Basis*</u>
H	1.0E+0	A	Sn	3.0E+3	B
Be	2.0E+0	B	Sb	2.0E+2	A
C	4.6E+3	B	Te	4.0E+2	B
N	1.5E+5	B	I	5.0E+2	A
F	1.0E+1	B	Cs	2.0E+3	B
Na	1.0E+2	A	Ba	2.0E+2	A
P	7.0E+4	A	La	2.5E+1	B
S	7.5E+2	B	Ce	5.0E+2	B
Cl	5.0E+1	B	Pr	2.5E+1	B
K	1.0E+3	B	Nd	2.5E+1	B
Ca	4.0E+1	B	Pm	2.5E+1	B
Sc	1.0E+2	A	Sm	2.5E+1	B
Cr	2.0E+2	B	Eu	2.5E+1	B
Mn	4.0E+2	A	Gd	2.5E+1	B
Fe	2.0E+3	A	Tb	2.5E+1	B
Co	3.3E+2	A	Ho	2.5E+1	B
Ni	1.0E+2	A	W	1.2E+3	B
Cu	5.0E+1	B	Re	1.2E+2	B
Zn	2.5E+3	A	Os	1.0E+1	B
As	1.0E+2	B	Ir	1.0E+1	B
Se	1.7E+2	B	Au	3.3E+1	B
Br	4.2E+2	B	Hg	1.0E+3	B
Rb	2.0E+3	B	Pb	1.0E+2	B
Sr	5.0E+1	A	Bi	1.5E+1	B
Y	2.5E+1	B	Po	5.0E+2	B
Zr	2.0E+2	A	Ra	7.0E+1	A
Nb	2.0E+2	A	Ac	2.5E+1	B
Mo	1.0E+1	A	Th	1.0E+2	A
Tc	1.5E+1	A	Pa	1.1E+1	B
Ru	1.0E+2	A	U	5.0E+1	A
Rh	1.0E+1	B	Np	2.5E+2	A
Pd	1.0E+1	B	Pu	2.5E+2	A
Ag	2.3E+0	B	Am	2.5E+2	A
Cd	2.0E+2	B	Cm	2.5E+2	A
In	1.0E+5	B	Cf	2.5E+1	B

*Values for fish bioaccumulation factors are based on: A - Poston and Klopfer (1988), B - Strenge, Peloquin, and Whelan (1986).

TEDEs in Volume 2 of this report. The parameters are described using the consistent symbol nomenclature defined in Section 2.1. Users of the screening model software will substitute site-specific values for the default values identified in this section, when they can justify doing so.

6.7.1 Parameters for the Building Renovation Scenario

Table 6.20 lists the parameters that may vary for the pathway analysis described in Section 3.1 for the building renovation scenario. Because this is a relatively simple scenario, only five parameters that may vary have been defined. The first two parameters (t_b and t_{tb}) are the time parameters for the scenario used for all exposure pathways. The next two parameters (V_b and CDB) define the volumetric breathing rate and the average airborne dust-loading in air during renovation work (described in Section 6.3.1), respectively. The final parameter (GB) is the effective transfer rate for ingestion of loose dust, described in Section 6.3.2, in units of g/h.

The time parameters, t_b and t_{tb} , are needed to define the extent of exposure during the renovation period. The exposure is evaluated using the time integral of activity over the renovation period to determine the mean activity level of each radionuclide or decay chain. These parameters could vary from a very short time period to a full year, depending on the type of building encountered and the type of renovation activity considered. An attempt has been made to assign prudently conservative default values for these parameters. The actual time spent on the renovation job (t_b) is assumed to be about 25% of a work year, 500 h or 20.83 d. The total duration of the renovation period (t_{tb}) is also assumed to be about 25% of a calendar year, or 90 calendar days. The combination of these parameter values provides a prudently conservative basis for the first-level screening analysis.

6.7.2 Parameters for the Building Occupancy Scenario

Table 6.21 lists the parameters that may vary for the pathway analysis described in Section 3.2 for the building occupancy scenario. Again, because this is a relatively simple scenario, only five parameters that may vary have been

Table 6.20 Building renovation scenario parameters that may vary and generic default values

Parameter symbol	Default	Units	Description/comments
t_b	20.83	d/y	The time on the job (converted to effective 24-h days) during the renovation period is based on working 40-h weeks over a 90-d period.
t_{tb}	90.	d	The duration of the renovation period is set to 3 months during the year.
V_b	1.2	m ³ /h	The volumetric breathing rate is set to the ICRP "light activity" value as an average for the 8-h renovation work day.
CDB	1.E-4	g/m ³	The average dust-loading in air during renovation work activities, as described in Section 6.3.1.
GB	1.E-2	g/h	The effective transfer rate for ingestion of loose dust during building renovation, as described in Section 6.3.2.

Table 6.21 Building occupancy scenario parameters that may vary and generic default values

Parameter symbol	Default	Units	Description/comments
t_o	83.33	d/y	The time in the building (converted to effective 24-h days) during the occupancy period is based on working 40-h weeks (or 2000 h) over the year.
t_{to}	365.25	d	The duration of the occupancy period is set to 1 year, representing continuous use.
V_o	1.2	m ³ /h	The volumetric breathing rate is set to the ICRP "light activity" value as an average for the 8-h renovation work day.
RF_o	1.E-6	m ⁻¹	The resuspension factor during the occupancy period, as described in Section 6.3.1.
GO	1.E-4	m ² /h	The secondary ingestion transfer rate of removable surface activity during building occupancy, as described in Section 6.3.2.

defined. These parameters are parallel to the parameters identified for the building renovation scenario because similar exposure pathways are used. The first two parameters (t_o and t_{to}) are the time parameters for the scenario used for all exposure pathways. The next two parameters (V_o and RF_o) define the volumetric breathing rate and the resuspension factor during the building occupancy scenario (described in Section 6.3.1), respectively. The final parameter (GO) is the secondary ingestion transfer rate of removable surface activity, described in Section 3.2.5, in units of m²/h.

The time parameter t_{to} is needed to determine the time integral of activity over the building occupancy period. This time integral is used to determine the mean activity level of each radionuclide or decay chain. These parameters could vary from a very short time period to a full year, depending on how many hours per year an employee is assumed to spend in the office or room during the year. The actual time spent on the job (t_o) is assumed to be 100% of a work year, 2000 h or 83.33 d. This parameter selection is prudently conservative when compared with continuous exposure for a full year (8766 h). The total duration of the occupancy period (t_{to}) is also assumed to be 100% of a calendar year, or 365.25 d, including a correction for leap year so that exact hand calculations may be performed using the equations contained in this report.

6.7.3 Parameters for the Drinking Water Scenario

Table 6.22 summarizes the parameters that may vary for the drinking water scenario. This table lists 10 different parameters, most of which are used in the water-use model described in Section 4.1. Again, an attempt has been made to select values that will result in a prudently conservative (not worst-case) analysis. Only two of the parameters shown in Table 6.22 are not related to the water-use model. These are the drinking water ingestion period, t_d (assumed to be a full year or 365.25 d), and the drinking water ingestion rate, U_w (assumed to be 2.0 L/d).

Eight parameters in Table 6.22 that may vary are identified with the water-use model. The first two are used to define the thickness of the top two boxes in the model. These boxes represent the surface soil (H_1) and the unsaturated zone (H_2). For this analysis, the top box is assumed to be 15-cm thick, or the same thickness assumed for the plow layer in

Table 6.22 Drinking water scenario parameters that may vary and generic default values

Parameter symbol	Default	Units	Description/comments
t_d	365.25	d/y	The drinking water ingestion period is based on continuous use.
U_w	2.0	L/d	Drinking water ingestion rate.
H_1 Fixed,	0.15	m	The thickness of surface-soil layer is set to equal the assumed plow layer.
H_2	1.0	m	The thickness of unsaturated zone.
n_1	0.3	-	The porosity of surface-soil associated with only partially compacted soils, as described in Oztunali et al. (1981).
n_2	0.3	-	The porosity of unsaturated zone, assumed to equal the porosity of the surface-soil.
f_1	1.0	-	Saturation ratio for the surface-soil layer.
f_2	1.0	-	Saturation ratio for the unsaturated-soil layer.
V_{dd}	91250	L	The annual dilution flow is set to the volume of water used by an individual for all domestic purposes during the year, as defined in Miller (1980).
I	0.18	m/y	Infiltration rate based on the high end of the range of infiltration rates determined for humid areas of the United States (Oztunali et al. 1981).
A_d	507	m ²	Area of contaminated site.
Kd_{1i}	Table 6.7	-	Surface soil partition coefficient, as described in Section 6.4.
Kd_{2i}	Table 6.7	-	Subsurface soil partition coefficient, assumed to be the same as the surface soil partition coefficient, as described in Section 6.4.

the agricultural pathway analysis and the same thickness for which external dose factors are defined for the residential scenario. The unsaturated zone is assumed to be 1-m thick. The next parameters represent the porosities of the top two boxes in the three-box water-use model (n_1 and n_2). For this study, the porosity for the top two boxes is assigned a single value of 0.3. This value was selected from the low-level waste management literature as being representative of surface soil that is in a partially compacted condition, as described in Oztunali et al. (1981). The annual dilution flow (V_{dd}) is set equal to the volume of water used by an individual for all purposes during the year, as defined by Miller (1980). This volume is taken to be 91,250 L, of which 2 L/d (or about 730 L/y) is used for drinking. The infiltration rate (I) is based on the high end of the range of infiltration rates determined for humid areas of the United States

(Oztunali et al. 1981). The default value for area of the contaminated site, A_d , is calculated from the pumping volume and the infiltration rate, based on the relationship given by Equation (4.14). Finally, partition coefficients (Kd_{1i} and Kd_{2i}) are derived using the methods described in Section 6.4. Although it may be likely that surface and subsurface-soils will be different, for the generic model analysis, a single set of partition coefficients has been identified for use in both soil layers. The use of the simple three-box water-use model with these conservative default parameter values provides a conservative estimate of the potential concentrations that could be present from residual radioactive contamination in soil. This conservative approach is intentionally adopted to ensure that the first-level screening produces conservative results.

These assumed values allow a generic analysis without attempting to account for site-specific conditions. As noted earlier, it is intended that users of the software (produced and documented in Volume 2 of this report) substitute, whenever possible, site-specific values for default values identified for this scenario to better account for site-specific conditions.

6.7.4 Parameters for the Residential Scenario

The most complicated scenario included in this analysis is the residential scenario. This scenario accounts for future use of contaminated land and includes leaching of radionuclides through the soil into the ground water, with redeposition on the land surface through irrigation. This scenario defines conditions for an individual who resides most of the year onsite and is involved in outdoor gardening activities. The time and pathway assumptions may not be representative of other lifestyles, such as suburban living, where the individual may spend less time outdoors and more time away from home. However, these assumptions are assumed to provide a conservative, complete pathway analysis. The scenario is described in a manner that permits enough pathway flexibility to accommodate modification into a suburban scenario by changing certain default parameters. Table 6.23 lists the parameters that may vary for the residential scenario. Several of the parameters, and their default values, are discussed in other sections of this report. Only those parameters that are not discussed elsewhere are described in this section.

The first four parameters define the times that the individual spends during the year involved in various activities around a house constructed on the land. They account for time spent indoors (t_i), outdoors (t_x), gardening (t_g), and the total time in the year (t_{tr}). Again, the hours of exposure for each of the time categories have been converted to effective days for unit consistency. The default exposure times are 200 d for t_i , 70.83 d for t_x , 4.17 d for t_g , and 365.25 d for t_{tr} .

For the external exposure pathway, two shielding factors have been defined for indoor (SFI) and outdoor (SFO) exposures. These factors are assumed to provide a correction for shielding by either building materials or clean cover soil, when justified. Although these factors should be dependent on the photon energy, single factors across all photon energies are used in this study to match the generic nature of the other simplifying assumptions made in the external dose analysis. The shielding factor afforded by the house is dependent on the type of house construction and the nature of the contaminated soil (i.e., the source thickness, size, and depth of clean cover soil). Previous studies have considered shielding factors associated with the atmospheric deposition of radioactive material from passing plumes after accidental airborne releases (Aldrich, Ericson, and Johnson 1978; Kocher 1978; Jensen 1985). Estimated shielding factors from these studies range from about 0.02 to 0.7, with the majority of the values reported from 0.04 to about 0.4 (Aldrich, Ericson, and Johnson 1978). The situation being modeled in this study is a bit different than a nuclear accident analysis because the dose is from contaminated soil around the house without plume deposition on the roof of the house. For this reason, a shielding factor of 0.33 is used for SFI. Although the shielding factor for outdoor exposures may vary, for this study it is assumed to be 1.0, representing surface-soil contamination with no clean soil cover.

Table 6.23 Residential scenario parameters that may vary and generic default values

Parameter symbol	Default	Units	Description/comments
t_i	200	d/y	Time in the 1-year exposure period that the individual spends indoors (effective days).
t_x	70.83	d/y	Time in the 1-year exposure period that the individual spends outdoors (effective days).
t_g	4.17	d/y	Time in the 1-year exposure period that the individual spends gardening (effective days).
t_{tr}	365.25	d	Total time in the 1-year exposure period.
SFI	0.33	-	Indoor shielding factor.
SFO	1.0	-	Outdoor shielding factor.
P_d	4.E-1	g/m^2	Floor dust-loading.
RF_r	5.E-5	m^{-1}	Resuspension factor for indoor dust, discussed in Section 6.3.1.
CDI	5.E-5	g/m^3	Air dust-loading indoors, discussed in Section 6.3.1.
CDO	1.E-4	g/m^3	Air dust-loading outdoors, discussed in Section 6.3.1.
CDG	5.E-4	g/m^3	Air dust-loading gardening, discussed in Section 6.3.1.
V_r	1.2	m^3/h	Volumetric breathing rate while indoors, based on the ICRP "light activity" value as an average for time spent indoors.
V_x	1.2	m^3/h	Volumetric breathing rate while outdoors, based on the ICRP "light activity" value as an average for time spent outdoors.
V_g	1.2	m^3/h	Volumetric breathing rate while gardening, based on the ICRP "light activity" value as an average for time spent gardening.
GR	5.E-2	g/d	Soil ingestion transfer rate for the residential scenario, as discussed in Section 6.3.2.
U_w	2	L/d	Drinking water ingestion rate.
H_1	0.15	m	The thickness of surface-soil layer is set to equal the assumed plow layer.
H_2	1.0	m	The thickness of unsaturated zone.

Fixed value

Parameter and Data Values

Table 6.23 Residential scenario parameters that may vary and generic default values (Continued)

Parameter symbol	Default	Units	Description/comments
n_1	0.3	-	The porosity of surface-soil associated with only partially compacted soils, described in Oztunali et al. (1981).
n_2	0.3	-	The porosity of unsaturated zone, assumed to equal the porosity of the surface-soil.
f_1	1.0	-	Saturation ratio for the surface-soil layer.
f_2	1.0	-	Saturation ratio for the unsaturated-soil layer.
V_{dr}	91,250	L	Volume of water removed from the ground-water aquifer per year for domestic uses.
V_{irr}	*	L	Volume of water removed from the ground-water aquifer per year for irrigation use, based on the irrigation rate.
V_{sw}	1.3E+6	L	Volume of water in the surface-water pond used to grow fish for the aquatic food ingestion pathway.
I	0.18	m/y	Infiltration rate based on the high end of the range of infiltration rates for humid areas of the United States (Oztunali et al. 1981).
Kd_{1i}	Table 6.7	-	Surface-soil partition coefficient, described in Section 6.4.
Kd_{2i}	Table 6.7	-	Unsaturated-soil partition coefficient, assumed to be the same as the surface-soil partition coefficient, described in Section 6.4.
A_r	2500	m ²	Area of land cultivated.
IR	2.08	L/m ² •d	Irrigation water application rate, corresponding to 76 cm/y.
P_s	240	kg/m ²	Soil areal density of surface plow layer.
DIET	0.25	-	Fraction of diet from garden.
U_v	11 51 46 69	kg/y kg/y kg/y kg/y	Human diet of leafy vegetables, discussed in Section 6.5.8. Human diet of other vegetables, discussed in Section 6.5.8. Human diet of fruits, discussed in Section 6.5.8. Human diet of grains, discussed in Section 6.5.8.
U_a	59 9 100	kg/y kg/y L/y	Human diet of beef, discussed in Section 6.5.8. Human diet of poultry, discussed in Section 6.5.8. Human diet of milk, discussed in Section 6.5.8.

Table 6.23 Residential scenario parameters that may vary and generic default values (Continued)

Parameter symbol	Default	Units	Description/comments
	10	kg/y	Human diet of egg, discussed in Section 6.5.8.
U_f	10	kg/y	Human diet of fish, discussed in Section 6.6.
t_{cv}	365.25	d	Food consumption period for leafy vegetables, discussed in Section 6.5.4.
	365.25	d	Food consumption period for other vegetables, discussed in Section 6.5.4.
	365.25	d	Food consumption period for fruits, discussed in Section 6.5.4.
	365.25	d	Food consumption period for grains, discussed in Section 6.5.4.
t_{ca}	365.25	d	Food consumption period for beef, discussed in Section 6.5.4.
	365.25	d	Food consumption period for poultry, discussed in Section 6.5.4.
	365.25	d	Food consumption period for milk, discussed in Section 6.5.4.
	365.25	d	Food consumption period for eggs, discussed in Section 6.5.4.
t_{hv}	1	d	Holdup period for leafy vegetables, discussed in Section 6.5.3.
	14	d	Holdup period for other vegetables, discussed in Section 6.5.3.
	14	d	Holdup period for fruits, discussed in Section 6.5.3.
	14	d	Holdup period for grains, discussed in Section 6.5.3.
t_{ha}	20	d	Holdup period for beef, discussed in Section 6.5.3.
	1	d	Holdup period for poultry, discussed in Section 6.5.3.
	1	d	Holdup period for milk, discussed in Section 6.5.3.
	1	d	Holdup period for eggs, discussed in Section 6.5.3.
t_{gv}	45	d	Minimum growing period for leafy vegetables, discussed in Section 6.5.5.
	90	d	Minimum growing period for other vegetables, discussed in Section 6.5.5.
	90	d	Minimum growing period for fruits, discussed in Section 6.5.5.
	90	d	Minimum growing period for grains, discussed in Section 6.5.5.
t_{gf}	30	d	Minimum growing period for forage consumed by beef cattle, discussed in Section 6.5.5.
	30	d	Minimum growing period for forage consumed by poultry, discussed in Section 6.5.5.
	30	d	Minimum growing period for forage consumed by milk cows, discussed in Section 6.5.5.
	30	d	Minimum growing period for forage consumed by layer hens, discussed in Section 6.5.5.

Table 6.23 Residential scenario parameters that may vary and generic default values (Continued)

Parameter symbol	Default	Units	Description/comments
t_{gg}	90	d	Minimum growing period for stored grain consumed by beef cattle, discussed in Section 6.5.5.
	90	d	Minimum growing period for stored grain consumed by poultry, discussed in Section 6.5.5.
	90	d	Minimum growing period for stored grain consumed by milk cows, discussed in Section 6.5.5.
	90	d	Minimum growing period for stored grain consumed by layer hens, discussed in Section 6.5.5.
t_{gh}	45	d	Minimum growing period for stored hay consumed by beef cattle, discussed in Section 6.5.5.
	45	d	Minimum growing period for stored hay consumed by poultry, discussed in Section 6.5.5.
	45	d	Minimum growing period for stored hay consumed by milk cows, discussed in Section 6.5.5.
	45	d	Minimum growing period for stored hay consumed by layer hens, discussed in Section 6.5.5.
r_v	0.25	-	Interception fraction for water deposition for leafy vegetables, discussed in Section 6.5.9.
	0.25	-	Interception fraction for water deposition for other vegetables, discussed in Section 6.5.9.
	0.25	-	Interception fraction for water deposition for fruits, discussed in Section 6.5.9.
	0.25	-	Interception fraction for water deposition for grains, discussed in Section 6.5.9.
r_f	0.25	-	Interception fraction for water deposition for forage consumed by beef cattle, discussed in Section 6.5.9.
	0.25	-	Interception fraction for water deposition for forage consumed by poultry, discussed in Section 6.5.9.
	0.25	-	Interception fraction for water deposition for forage consumed by milk cows, discussed in Section 6.5.9.
	0.25	-	Interception fraction for water deposition for forage consumed by layer hens, discussed in Section 6.5.9.
r_g	0.25	-	Interception fraction for water deposition for stored grain consumed by beef cattle, discussed in Section 6.5.9.
	0.25	-	Interception fraction for water deposition for stored grain consumed by poultry, discussed in Section 6.5.9.

Table 6.23 Residential scenario parameters that may vary and generic default values (Continued)

Parameter symbol	Default	Units	Description/comments
	0.25	-	Interception fraction for water deposition for stored grain consumed by milk cows, discussed in Section 6.5.9.
	0.25	-	Interception fraction for water deposition for stored grain consumed by layer hens, discussed in Section 6.5.9.
r_h	0.25	-	Interception fraction for water deposition for stored hay consumed by beef cattle, discussed in Section 6.5.9.
	0.25	-	Interception fraction for water deposition for stored hay consumed by poultry, discussed in Section 6.5.9.
	0.25	-	Interception fraction for water deposition for stored hay consumed by milk cows, discussed in Section 6.5.9.
	0.25	-	Interception fraction for water deposition for stored hay consumed by layer hens, discussed in Section 6.5.9.
T_v	1.0	-	Translocation factor for leafy vegetables, described in Section 6.5.6.
	0.1	-	Translocation factor for other vegetables, described in Section 6.5.6.
	0.1	-	Translocation factor for fruits, described in Section 6.5.6.
	0.1	-	Translocation factor for grains, described in Section 6.5.6.
T_f	1.0	-	Translocation factor for forage consumed by beef cattle, described in Section 6.5.6.
	1.0	-	Translocation factor for forage consumed by poultry, described in Section 6.5.6.
	1.0	-	Translocation factor for forage consumed by milk cows, described in Section 6.5.6.
	1.0	-	Translocation factor for forage consumed by layer hens, described in Section 6.5.6.
T_g	0.1	-	Translocation factor for stored grain consumed by beef cattle, described in Section 6.5.6.
	0.1	-	Translocation factor for stored grain consumed by poultry, described in Section 6.5.6.
	0.1	-	Translocation factor for stored grain consumed by milk cows, described in Section 6.5.6.
	0.1	-	Translocation factor for stored grain consumed by layer hens, described in Section 6.5.6.
T_h	1.0	-	Translocation factor for stored hay consumed by beef cattle, described in Section 6.5.6.
	1.0	-	Translocation factor for stored hay consumed by poultry, described in Section 6.5.6.

Parameter and Data Values

Table 6.23 Residential scenario parameters that may vary and generic default values (Continued)

Parameter symbol	Default	Units	Description/comments
	1.0	-	Translocation factor for stored hay consumed by milk cows, described in Section 6.5.6.
	1.0	-	Translocation factor for stored hay consumed by layer hens, described in Section 6.5.6.
x_f	1.0	-	Fraction of contaminated forage consumed by beef cattle, described in Section 6.5.1.
	1.0	-	Fraction of contaminated forage consumed by poultry, described in Section 6.5.1.
	1.0	-	Fraction of contaminated forage consumed by milk cows, described in Section 6.5.1.
	1.0	-	Fraction of contaminated forage consumed by layer hens, described in Section 6.5.1.
x_g	1.0	-	Fraction of contaminated stored grain consumed by beef cattle, described in Section 6.5.1.
	1.0	-	Fraction of contaminated stored grain consumed by poultry, described in Section 6.5.1.
	1.0	-	Fraction of contaminated stored grain consumed by milk cows, described in Section 6.5.1.
	1.0	-	Fraction of contaminated stored grain consumed by layer hens, described in Section 6.5.1.
x_h	1.0	-	Fraction of contaminated stored hay consumed by beef cattle, described in Section 6.5.1.
	1.0	-	Fraction of contaminated stored hay consumed by poultry, described in Section 6.5.1.
	1.0	-	Fraction of contaminated stored hay consumed by milk cows, described in Section 6.5.1.
	1.0	-	Fraction of contaminated stored hay consumed by layer hens, described in Section 6.5.1.
x_w	1.0	-	Fraction of contaminated water consumed by beef cattle, described in Section 6.5.1.
	1.0	-	Fraction of contaminated water consumed by poultry, described in Section 6.5.1.
	1.0	-	Fraction of contaminated water consumed by milk cows, described in Section 6.5.1.
	1.0	-	Fraction of contaminated water consumed by layer hens, described in Section 6.5.1.
Y_v	2.0	kg/m ²	Crop yields for leafy vegetables, described in Section 6.5.7.
	4.0	kg/m ²	Crop yields for other vegetables, described in Section 6.5.7.

Table 6.23 Residential scenario parameters that may vary and generic default values (Continued)

Parameter symbol	Default	Units	Description/comments
	2.0	kg/m ²	Crop yields for fruits, described in Section 6.5.7.
	1.0	kg/m ²	Crop yields for grains, described in Section 6.5.7.
Y _f	1.0	kg/m ²	Crop yields for forage consumed by beef cattle, described in Section 6.5.7.
	1.0	kg/m ²	Crop yields for forage consumed by poultry, described in Section 6.5.7.
	1.5	kg/m ²	Crop yields for forage consumed by milk cows, described in Section 6.5.7.
	1.0	kg/m ²	Crop yields for forage consumed by layer hens, described in Section 6.5.7.
Y _g	1.0	kg/m ²	Crop yields for stored grain consumed by beef cattle, described in Section 6.5.7.
	1.0	kg/m ²	Crop yields for stored grain consumed by poultry, described in Section 6.5.7.
	1.0	kg/m ²	Crop yields for stored grain consumed by milk cows, described in Section 6.5.7.
	1.0	kg/m ²	Crop yields for stored grain consumed by layer hens, described in Section 6.5.7.
Y _h	1.5	kg/m ²	Crop yields for stored hay consumed by beef cattle, described in Section 6.5.7.
	1.0	kg/m ²	Crop yields for stored hay consumed by poultry, described in Section 6.5.7.
	1.5	kg/m ²	Crop yields for stored hay consumed by milk cows, described in Section 6.5.7.
	1.0	kg/m ²	Crop yields for stored hay consumed by layer hens, described in Section 6.5.7.
W _v	0.2	-	Wet-to-dry-weight conversion factors for leafy vegetables, described in Section 6.5.9.
	0.25	-	Wet-to-dry-weight conversion factors for other vegetables, described in Section 6.5.9.
	0.18	-	Wet-to-dry-weight conversion factors for fruits, described in Section 6.5.9.
	0.91	-	Wet-to-dry-weight conversion factors for grains, described in Section 6.5.9.

Table 6.23 Residential scenario parameters that may vary and generic default values (Continued)

Parameter symbol	Default	Units	Description/comments
W_f	0.22	-	Wet-to-dry-weight conversion factors for forage consumed by beef cattle, described in Section 6.5.9.
	0.22	-	Wet-to-dry-weight conversion factors for forage consumed by poultry, described in Section 6.5.9.
	0.22	-	Wet-to-dry-weight conversion factors for forage consumed by milk cows, described in Section 6.5.9.
	0.22	-	Wet-to-dry-weight conversion factors for forage consumed by layer hens, described in Section 6.5.9.
W_g	0.91	-	Wet-to-dry-weight conversion factors for stored grain consumed by beef cattle, described in Section 6.5.9.
	0.91	-	Wet-to-dry-weight conversion factors for stored grain consumed by poultry, described in Section 6.5.9.
	0.91	-	Wet-to-dry-weight conversion factors for stored grain consumed by milk cows, described in Section 6.5.9.
	0.91	-	Wet-to-dry-weight conversion factors for stored grain consumed by layer hens, described in Section 6.5.9.
W_h	0.22	-	Wet-to-dry-weight conversion factors for stored hay consumed by beef cattle, described in Section 6.5.9.
	0.22	-	Wet-to-dry-weight conversion factors for stored hay consumed by poultry, described in Section 6.5.9.
	0.22	-	Wet-to-dry-weight conversion factors for stored hay consumed by milk cows, described in Section 6.5.9.
	0.22	-	Wet-to-dry-weight conversion factors for stored hay consumed by layer hens, described in Section 6.5.9.
Q_f	27	kg/d	Animal feed intake rates for forage consumed by beef cattle, described in Section 6.5.1.
	0.13	kg/d	Animal feed intake rates for forage consumed by poultry, described in Section 6.5.1.
	36	kg/d	Animal feed intake rates for forage consumed by milk cows, described in Section 6.5.1.
	0.13	kg/d	Animal feed intake rates for forage consumed by layer hens, described in Section 6.5.1.
Q_g	3	kg/d	Animal feed intake rates for stored feed consumed by beef cattle, described in Section 6.5.1.
	0.09	kg/d	Animal feed intake rates for stored feed consumed by poultry stored feed, described in Section 6.5.1.
	2	kg/d	Animal feed intake rates for stored feed consumed by milk cows, described in Section 6.5.1.

Table 6.23 Residential scenario parameters that may vary and generic default values (Continued)

Parameter symbol	Default	Units	Description/comments
	0.09	kg/d	Animal feed intake rates for stored feed consumed by layer hens, described in Section 6.5.1.
Q_h	14	kg/d	Animal feed intake rates for stored hay consumed by beef cattle, described in Section 6.5.1.
	0	kg/d	Animal feed intake rates for stored hay consumed by poultry, described in Section 6.5.1.
	29	kg/d	Animal feed intake rates for stored hay consumed by milk cows, described in Section 6.5.1.
	0	kg/d	Animal feed intake rates for stored hay consumed by layer hens, described in Section 6.5.1.
Q_w	50	L/d	Water intake rates for beef cattle, described in Section 6.5.1.
	0.3	L/d	Water intake rates for poultry, described in Section 6.5.1.
	60	L/d	Water intake rates for milk cows, described in Section 6.5.1.
	0.3	L/d	Water intake rates for layer hens, described in Section 6.5.1.
Q_d	0.02	-	Beef cattle soil-intake fractions (forage diet, dry-weight), described in Section 6.5.1.
	0.1	-	Poultry soil-intake fractions (forage diet, dry-weight), described in Section 6.5.1.
	0.02	-	Milk cow soil-intake fractions (forage diet, dry-weight), described in Section 6.5.1.
	0.1	-	Layer hen soil-intake fractions (forage diet, dry-weight), described in Section 6.5.1.
BA_{if}	Table 6.19	-	Fish bioaccumulation factors, wet-weight basis, discussed in Section 6.6.
B_{jv}	Table 6.16	-	Vegetation concentration factors, dry-weight basis, described in Section 6.5.9.
F_{aj}	Table 6.18	d/kg	Animal product transfer factors, wet-weight basis, described in Section 6.5.9.

Parameter and Data Values

A potentially significant pathway of inhalation exposure is resuspension of contaminated soil tracked indoors. This pathway is dependent on the floor dust-loading (P_d) and the resuspension factor. Indoor dust-loadings may vary over a wide range and are dependent on a number of factors. A representative value from recent literature for indoor dust is 0.4 g/m^2 of floor surface.^(a) The resuspension factor used in this analysis for estimating indoor air concentrations is discussed in Section 6.3.1.

The parameters used to determine the ground-water concentration using the three-box water-use model are generally the same as those described for the drinking water scenario. The significant exception is the method used for estimating the annual dilution flow (F) within the aquifer (box 3). As shown in Table 6.23, F is evaluated from the irrigation rate (IR), the area under irrigation (A), and assumed domestic use of land. The residential scenario is based on the assumption that 2500 m^2 of land are under irrigation at an irrigation rate of $2.08 \text{ L/m}^2 \cdot \text{d}$, or 76 cm/y . This irrigation rate is within a range of potential irrigation rates for various crops in the western United States. The Specific Information on the Terrestrial Environmental (SITE) database referenced by Baes et al. (1984b) shows the geographic distribution of estimated annual average irrigation rates across the country. While a large percentage of the United States is not irrigated at all, a prudently conservative exposure scenario will include irrigation. This is a significant pathway for contamination in ground water to reach food products and surface soil. Baes et al. (1984a) show a few very dry areas with irrigation rates in excess of 100 cm/y ; however, this value would be overly conservative because it is the maximum listed. A large geographical percentage of the drier western states irrigates at a rate of $70\text{-}85 \text{ cm/y}$; the default value of 76 cm/y selected for this study falls within this range. Although the default value is conservative when compared with the annual irrigation rates in the eastern United States, it is representative of the rates in the western United States. This default value is adopted to ensure that the irrigation pathway in the residential scenario produces conservative first-level generic screening results. The total volume of water needed for irrigation is about $1.9 \times 10^7 \text{ L}$. The volume of water needed for domestic purposes is $91,250 \text{ L}$, and the volume of the surface-water pond is $1.3 \times 10^6 \text{ L}$. The total aquifer size is the sum of these three water volumes, or $2.0 \times 10^7 \text{ L}$.

Summaries of the default parameter values for the ^{14}C and ^3H agricultural models are shown in Tables 6.24 and 6.25, respectively. The ^{14}C model and default parameter values are described in Appendix C, and the ^3H model and default parameter values are described in Appendix D.

The pathway and default parameter selections for the residential scenario have been made to model typical conditions that could be encountered at most sites across the United States. They are selected to provide a conservative estimate of the potential radiation doses that could result from residual radioactive contamination in soil. This approach is adopted to ensure that the first-level generic screening produces conservative results.

(a) Based on personal communication from Dr. D. W. Layton, Lawrence Livermore National Laboratory (November 27, 1991), regarding his recent literature review of the amounts of dust/dirt on the floors of homes. Dr. Layton stated that the 0.4 g dust/m^2 represents a geometric mean of the values found in his literature review.

Table 6.24 ^{14}C model residential scenario parameters that may vary and generic default values*

Parameter symbol	Default	Units	Description/comments
f_{Ca}	0.24	-	Fraction of carbon in beef cattle.
	0.20	-	Fraction of carbon in poultry.
	0.07	-	Fraction of carbon in milk cows.
	0.15	-	Fraction of carbon in layer hens.
f_{Cf}	0.09	-	Fraction of carbon in forage: beef cattle.
	0.09	-	Fraction of carbon in forage: poultry.
	0.09	-	Fraction of carbon in forage: milk cows.
	0.09	-	Fraction of carbon in forage: layer hens.
f_{Cg}	0.4	-	Fraction of carbon in stored grain: beef cattle.
	0.4	-	Fraction of carbon in stored grain: poultry.
	0.4	-	Fraction of carbon in stored grain: milk cows.
	0.4	-	Fraction of carbon in stored grain: layer hens.
f_{Ch}	0.09	-	Fraction of carbon in stored hay: beef cattle.
	0.09	-	Fraction of carbon in stored hay: poultry.
	0.09	-	Fraction of carbon in stored hay: milk cows.
	0.09	-	Fraction of carbon in stored hay: layer hens.
f_{Cs}	0.03	-	Fraction of soil that is carbon.
SA_{aTC}	1.0	-	Specific activity equivalence: beef cattle.
	1.0	-	Specific activity equivalence: poultry.
	1.0	-	Specific activity equivalence: milk cows.
	1.0	-	Specific activity equivalence: layer hens.

*Details of the ^{14}C model for the agricultural pathways are provided in Appendix C.

Parameter and Data Values

Table 6.25 ³H model residential scenario parameters that may vary and generic default values*

Parameter symbol	Default	Units	Description/comments
H*	0.008	L/m ³	Absolute humidity.
SH	0.1	L/kg	Moisture content of soil.
SA _{svH}	1.0	-	Tritium equivalence: plant/soil.
SA _{wwH}	1.0	-	Tritium equivalence: plant/water.
SA _{TaH}	1.0	-	Tritium equivalence: animal product/intake.
f _{Hv}	0.1	-	Fraction of hydrogen: leafy vegetables.
	0.1	-	Fraction of hydrogen: other vegetables.
	0.1	-	Fraction of hydrogen: fruit.
	0.068	-	Fraction of hydrogen: grains.
f _{Hf}	0.1	-	Fraction of hydrogen in forage: beef cattle.
	0.1	-	Fraction of hydrogen in forage: poultry.
	0.1	-	Fraction of hydrogen in forage: milk cows.
	0.1	-	Fraction of hydrogen in forage: layer hens.
f _{Hg}	0.068	-	Fraction of hydrogen in stored grain: beef cattle.
	0.068	-	Fraction of hydrogen in stored grain: poultry.
	0.068	-	Fraction of hydrogen in stored grain: milk cows.
	0.068	-	Fraction of hydrogen in stored grain: layer hens.
f _{Hh}	0.10	-	Fraction of hydrogen in stored hay: beef cattle.
	0.10	-	Fraction of hydrogen in stored hay: poultry.
	0.10	-	Fraction of hydrogen in stored hay: milk cows.
	0.10	-	Fraction of hydrogen in stored hay: layer hens.
f _{Ha}	0.10	-	Fraction of hydrogen in beef cattle.
	0.10	-	Fraction of hydrogen in poultry.
	0.11	-	Fraction of hydrogen in milk cows.
	0.11	-	Fraction of hydrogen in layer hens.
f _{Hs}	0.011	-	Fraction of soil that is hydrogen based on a soil moisture content (SH) of 0.1.

*Details of the ³H model for the agricultural pathways are provided in Appendix D.

7 Discussion

The models and equations presented in this volume provide a method for calculation of radiation doses from residual radioactive contamination in buildings and soil. Four scenarios are included. For buildings, the scenarios cover the building renovation and building occupancy conditions, as described in Section 3. For soils, a generic water-use model, described in Sections 4 and 5, is used to provide time-dependent concentrations of radionuclides in water used for drinking and/or irrigation. The two scenarios for soils included are the drinking water scenario described in Section 4 and the residential scenario, as described in Section 5. The residential scenario is used to estimate doses from residual radioactivity in soil, including use of ground water for drinking, irrigation of farm products, and for obtaining fish from a surface pond. The selected parameter values and a summary of parameters that may vary are presented in Section 6. This section discusses the generic modeling approach, the generic scenarios and their limitations, and the potential applications of the models and methods.

7.1 Generic Modeling Approach

The generic modeling evaluation relies on a radiation exposure scenario analysis, including the major exposure pathways of direct exposure to penetrating radiation, inhalation, and ingestion. The modeling analysis is used to derive the annual TEDE to an average individual in a population exposed to residual radioactive material after decommissioning. The input parameters for each exposure pathway and scenario are selected to provide a prudently conservative estimate of the potential annual radiation dose. The parameters generally do not represent average conditions for all individuals exposed; however, they were not selected to perform a worst-case (overly conservative) analysis of the potential radiation dose to a maximally exposed individual. Rather, the parameters were chosen from documented sources and previous analyses on the basis of the professional judgment of the study contributors. Although the dose estimates produced may be overestimations in some cases, they are considered to be generally more realistic than the large overestimations produced by analysis of bounding cases. It is possible that for a few situations, the parameters chosen could lead to an underestimate of the annual TEDE.

The exception to this approach is the generic water-use analysis considered in this study. To estimate ground-water concentrations, a simple three-box, leach-rate model was developed using parameters and assumptions from literature sources. In this analysis, geometric mean partition coefficients (K_d 's) data for the most mobile form of each element were obtained from literature sources, for those elements for which data existed. Where literature data were not available, K_d 's were estimated using soil-to-plant concentration ratios as defined for leafy vegetables using a conservative correlation for soils. In a similar manner, infiltration rate and porosity values were selected based on the high end of the range of infiltration rates and porosities determined for humid areas of the United States. The ground-water parameter values and concentration equations selected for this analysis provide a conservative analysis of potential ground-water concentrations.

Generic screening modeling evaluations, similar to the one described in this document, have become a rather common approach to setting risk-based radiation protection standards. They are useful in evaluating a wide variety of conditions; however, they often have limitations that need to be recognized. Models are intended to be an approximation of reality. Because of data limitations or lack of knowledge, generic modeling sometimes oversimplifies actual conditions and may not account for important physical or chemical processes. When this occurs, or when it is suspected, attempts are made to use conservative assumptions and parameter selections to ensure that potential adverse consequences are overestimated. That is, where detailed knowledge is unavailable, an intentional error is introduced to provide a greater margin for safety. The results obtained by overestimating the adverse consequences may not be very useful because they may lead to prohibitive expenses for cleanup to meet regulatory requirements. However, for

simple cases where trivial contamination exists, compliance reached by generic screening modeling is beneficial because it eliminates unwarranted regulation and expense while not significantly affecting public health and safety.

For more complex situations, where a wide variation of contamination levels, radionuclide mixtures, and physical/chemical properties exist, generic models and data sets may not produce a very convincing assurance of compliance. When complex conditions occur, site-specific data should be used, if possible, and modifications to the generic approach should be made to account for the actual conditions. For example, direct measurements of radiation fields and their variation provide more meaningful information than generic attempts to model dose rates from contamination levels (i.e., actual measurements may obviate the need to model). A dilemma occurs when the costs of characterizing a site escalate beyond the basic demolition and waste disposal costs. The tendency in this situation may be to comply with a more restrictive generic limit than to attempt a full site characterization and compliance with a site-specific limit. However, a carefully conducted and documented optimization/ALARA evaluation may be used to help justify the adoption of site-specific derived levels, as described in the Foreword.

7.2 Generic Scenarios

For residual contamination in buildings, this document provides scenarios and mathematical formulations to derive annual TEDE factors that account for both potential building renovation (accounting for volume contamination sources) and routine building occupancy (accounting for surface contamination sources). These two scenarios were developed in an attempt to account for questions about the relative importance of volume versus surface activity and fixed versus removable contamination. For many alpha- and beta-emitting radionuclides, direct survey measurements may only account for surface activity because of self-shielding. Surface measurement methods may not detect subsurface sources, and significant inventories of radioactive material may be missed. Surface contamination that is fixed (i.e., not easily removed by smearing) at the time of release may become removable with time. Loose surface contamination may result in additional radiation exposure pathways and higher estimated radiation doses, as described by scenarios and parameter values defined in this document. Because unrestricted release is considered, it cannot be assumed that subsurface sources or fixed contamination will remain that way after license termination. The two scenarios identified for buildings attempt to account for this potential situation. No attempt was made to model indoor radon concentrations that may result from residual ^{226}Ra in buildings.

Residual radioactive soil contamination may be in a thin or thick soil layer, reside on the surface or be stabilized under a clean soil layer, cover a large or small area, and consist of many different radionuclides or mixtures of radionuclides. The scenarios and mathematical formulations contained in this volume relate to surface soils and are based on a scenario analysis that combines exposure pathways for inhalation, external exposure, ingestion of contaminated drinking water, and ingestion of soil and agricultural food products, including fish from a pond. The residential scenario was intentionally developed in a conservative manner to account for potential residential and light agricultural activities. It is recognized that, for sites located in industrial or urban areas, the potential for even light agricultural activities may be remote. Again, no attempt was made to model the indoor radon aerosol concentrations that could result from residual ^{226}Ra soil contamination.

The wide variability of physical and chemical conditions that potentially influence ground water, and the dependence on many parameters that may have a coupled dependency, make it difficult to model ground-water systems. In addition, a conceptual model of a ground-water system may not represent all the behavior of that system. Generic attempts at modeling ground-water systems generally encourage the use of overly conservative parameters, assumptions, and models. As a result, most generic modeling attempts have little meaning when compared with a real system. The existence of site-specific data may encourage a site-specific modeling effort, but such data are relatively costly to obtain, may be point values (both in time and location), and may not appropriately represent the actual system being modeled.

The purpose of the generic modeling in this document is to derive an aquifer concentration from residual radioactive materials in soil (or in building materials that may ultimately be buried as rubble onsite) in a conservative manner to permit screening and to indicate when additional site data or modeling sophistication are warranted. This approach is not intended for broader applications such as application to buried sources, disposed wastes, or sites with a history of spills contaminating soil deeper than 15 cm. Rather, it is intended to support the development of screening values, as described in the Foreword.

7.3 Applications

The annual doses estimated using these scenarios are to be used to provide an indication of the potential for license termination of a site by comparison of the calculated doses to a dose limit (to be set by NRC policy). The comparison can be made in two ways: by simply using precalculated TEDE screening factors, defining the concentration of each radionuclide that equals the dose limit, or through site-specific calculations relating measured residual concentrations to annual dose. The equations in this report are incorporated into a computer program that can perform both of these types of calculations. The program, to be documented in Volume 2, will also allow modifications to the scenario calculations to be performed using site-specific parameters defined by a user, as described in Section 6. For both methods, the user must have an estimate of the radionuclide inventory present.

Annual TEDE screening factors for the full set of radionuclides of interest will be calculated per unit activity of each parent radionuclide and provided in Volume 2 of this report. For sites that are well described by the set of default parameters identified in this volume, an indication of potential impacts can be made using these derived unit annual TEDE screening factors. For any scenario, the following evaluation can be made:

$$\text{Dose Ratio} = \sum_{i=1}^M C_{mi} \text{TEDE}_i / \text{DL} \quad (7.1)$$

where Dose Ratio = indicator of impact for the mixture of radionuclides at the site for a scenario of interest (dimensionless)

C_{mi} = inventory of radionuclide i in the medium m upon which the scenario is based (pCi/medium)

TEDE_i = annual TEDE per unit activity of radionuclide i in the medium for the scenario of interest (mrem per pCi/medium) for a year of scenario exposure

DL = annual dose limit for evaluation of the potential for adverse impacts (mrem).

When site-specific parameter values are available, the computer program will allow a second-level screening analysis to be made using these parameter values instead of the default values identified in Section 6. Under this mode of operation, the program will provide an estimate of the total dose from the user-defined mixture of radionuclides for each scenario of interest. The results from this analysis, in the form of annual TEDEs, are compared to the dose limit as follows:

Discussion

$$\text{Dose Ratio} = \text{TEDE}_m / \text{DL} \quad (7.2)$$

where TEDE_m is the annual TEDE for the mixture of radionuclides in the medium for the scenario of interest (mrem) for a year of scenario exposure and DL is as previously defined.

8 References

- 10 CFR 61. 1990. U.S. Nuclear Regulatory Commission, "Licensing Requirements for Land Disposal of Radioactive Waste." U.S. Code of Federal Regulations.
- 29 CFR 1910.1000. 1990. U.S. Occupational Safety and Health Administration, Department of Labor, "Occupational Safety and Health Standards - Subpart Z - Toxic and Hazardous Substances." U.S. Code of Federal Regulations.
- 46 FR 52061-3. October 23, 1981. "Disposal or Onsite Storage of Thorium or Uranium Wastes from Past Operations." *Federal Register*.
- 50 FR 5190. February 6, 1985. "National Emission Standards for Hazardous Pollutants; Standards for Radionuclides." (40 CFR 61) *Federal Register*.
- 56 FR 23360-23474. May 21, 1991. "Standards for Protection Against Radiation." (10 CFR 20) *Federal Register*.
- Aldrich, D.C., D. M. Ericson, Jr., and J. D. Johnson. 1978. *Public Protection Strategies for Potential Nuclear Reactor Accidents: Sheltering Concepts with Existing Public and Private Structures*. SAND77-1725, Sandia Laboratories, Albuquerque, New Mexico.
- Altman, P. L., and D. S. Dittmer. 1974. *Biology Data Book, Vol. III*. 2nd ed. Federation of American Societies for Experimental Biology, Bethesda, Maryland.
- American Conference of Governmental Industrial Hygienists (ACGIH). 1987. *TLVs, Threshold Limit Values for Chemical Substances and Physical Agents in the Work Environment with Intended Changes for 1987-1988*. ACGIH, Cincinnati, Ohio.
- Anspaugh, L. R., P. L. Phelps, N. C. Kennedy, H. G. Booth, R. W. Goluba, J. M. Reichman, and J. S. Koval. 1974. *The Dynamics of Plutonium in Desert Environments*. NVO-142, U.S. Atomic Energy Commission, Nevada Operations Office, Las Vegas, Nevada.
- Anspaugh, L. R., J. H. Shinn, P. L. Phelps, and N. C. Kennedy. 1975. "Resuspension and Redistribution of Plutonium in Soils." *Health Physics* 29:571-582.
- Arthur, III, W. J., and A. W. Alldredge. 1982. "Importance of Plutonium Contamination on Vegetation Surfaces at Rocky Flats, Colorado." *Environ. Experiment. Botany* 22:33-38.
- Baes, III, C. F., R. D. Sharp, A. L. Sjoreen, and O. W. Hermann. 1984a. *TERRA: A Computer Code for Simulating the Transport of Environmentally Released Radionuclides Through Agriculture*. ORNL-5785, Oak Ridge National Laboratory, Oak Ridge, Tennessee.
- Baes, III, C. F., III, R. D. Sharp, A. L. Sjoreen, and R. W. Shor. 1984b. *A Review and Analysis of Parameters for Assessing Transport of Environmentally Released Radionuclides Through Agriculture*. ORNL-5786, Oak Ridge National Laboratory, Oak Ridge, Tennessee.
- Bardach, J. E., J. H. Ryther, and W. O. McLarney. 1972. *Aquaculture*. John Wiley and Sons, Inc., New York.

References

- Berger, J. D. 1992. *Manual for Conducting Radiological Surveys in Support of License Termination*. NUREG/CR-5849 CORAU-92/C57). U. S. Nuclear Regulatory Commission, Washington, D.C.
- Binder, S., D. Sokal, and D. Maughan. 1986. "Estimating Soil Ingestion: The Use of Tracer Elements in Estimating the Amount of Soil Ingested by Young Children." *Archives of Environ. Health* 41:341-345.
- Calabrese, E. J., R. M. Barnes, E. J. Stanek III, H. Pastides, C. E. Gilbert, P. Veneman, X. Wang, A. Lasztity, and P. T. Kosteci. 1989. "How Much Soil Do Young Children Ingest: An Epidemiologic Study." *Regulatory Toxicology and Pharmacology* 10:123-137.
- Calabrese, E. J., and E. J. Stanek. 1991. "A Guide to Interpreting Soil Ingestion Studies." *Regulatory Toxicology and Pharmacology* 13:278-292.
- Calabrese, E. J., E. J. Stanek, C. E. Gilbert, and R. M. Barnes. 1990. "Preliminary Adult Soil Ingestion Estimates: Results of a Pilot Study." *Regulatory Toxicology and Pharmacology* 12:88-95.
- Codell, R. B. 1984. *Simplified Analysis for Liquid Pathway Studies*. NUREG-1054, U.S. Nuclear Regulatory Commission, Washington, D.C.
- Codell, R. B., K. T. Key, and G. Whelan. 1982. *A Collection of Mathematical Models for Dispersion in Surface Water*. NUREG-0868, U.S. Nuclear Regulatory Commission, Washington, D.C.
- Davis, S., P. Waller, R. Buschbom, J. Ballou, and P. White. 1990. "Quantitative Estimates of Soil Ingestion in Normal Children Between the Ages of 2 and 7 Years: Population-Based Estimates Using Aluminum, Silicon and Titanium as Soil Tracer Elements." *Arc. Environ. Health* 45 (2):112-122.
- Dreicer, M., T. E. Hakonson, G. C. White, and F. W. Wicker. 1984. "Rainsplash as a Mechanism for Soil Contamination of Plant Surfaces." *Health Physics* 46:177-187.
- Dunster, H. J. 1962. *Maximum Permissible Levels of Skin Contamination*. AHSB(RP)R28, United Kingdom Atomic Energy Authority, London.
- Eckerman, K. F., and J. C. Ryman. 1992. *Dose Coefficients for External Exposure to Radionuclides Distributed in Air, Water, and Soil*. Federal Guidance Report No. 12, U.S. Environmental Protection Agency, Washington, D.C.
- Eckerman, K. F., A. B. Wolbarst, and A. C. B. Richardson. 1988. *Limiting Values of Radionuclide Intake and Air Concentration and Dose Conversion Factors for Inhalation, Submersion, and Ingestion*. Federal Guidance Report No. 11, EPA-520/1-88-020, U.S. Environmental Protection Agency, Washington, D.C.
- Engel, R. L., J. Greenborg, and M. M. Hendrickson. 1966. *ISOSHL D - A Computer Code for General Purpose Isotope Shielding Analysis*. BNWL-236, Pacific Northwest Laboratory, Richland, Washington.
- Freeze, R. A., and J. A. Cherry. 1979. *Groundwater*. Prentice-Hall, Inc., Englewood Cliffs, New Jersey.
- Fries, G. F. 1982. "Potential Polychlorinated Biphenyl Residues in Animal Products from Application of Contaminated Sewage Sludge to Land." *J. Environ. Qual.* 11:14-20.

- Fries, G. F. 1987. "Assessment of Potential Residues in Foods Derived from Animals Exposed to TCDD-Contaminated Soil." *Chemosphere* 16(8/9):2123-2128.
- Gallacher, J. E. J., P. C. Elwood, K. M. Phillips, B. E. Davies, and D. T. Jones. 1984. "Relation Between Pica and Blood Lead in Areas of Differing Lead Exposure." *Archives of Disease in Childhood* 59:40-44.
- Garland, J. A., and N. J. Pattenden. 1990. "Resuspension Following Chernobyl." In *Proceedings of the Seminar on Methods and Codes for Assessing the Off-Site Consequences of Nuclear Accidents, Vol. I*. Report EUR 13013, Commission of the European Communities, Brussels.
- Gibson, J. A. B., and A. D. Wrixon. 1979. "Methods for the Calculation of Derived Working Limits for Surface Contamination by Low-Toxicity Radionuclides." *Health Physics* (36)3:311-321.
- Gilbert, R. O., D. W. Engel, and L. R. Anspaugh. 1989. "Transfer of Aged $^{239+240}\text{Pu}$, ^{238}Pu , ^{241}Am , and ^{137}Cs to Cattle Grazing a Contaminated Arid Environment." *Sci. Total Environ.* 85:53-62.
- Gilbert, T. L., C. Yu, Y. C. Yuan, A. J. Zielen, M. J. Jusko, and A. Wallo, III. 1989. *A Manual for Implementing Residual Radioactive Material Guidelines*. DOE/CH/8901 (ANL/ES-160), U.S. Department of Energy, Washington, D.C.
- Goode, D. J., S. M. Neuder, R. A. Pennifill, and T. Ginn. 1986. *Onsite Disposal of Radioactive Waste*. NUREG-1101, Vol. 3, U.S. Nuclear Regulatory Commission, Washington, D.C.
- Green, N., and N. J. Dodd. 1988. "The Uptake of Radionuclides from Inadvertent Consumption of Soil by Grazing Animals." *Sci. Total Environ.* 69:367-377.
- Hawley, J. K. 1985. "Assessment of Health Risk from Exposure to Contaminated Soil." *Risk Analysis* 5(4):289-302.
- Healy J. W. 1971. *Surface Contamination: Decision Levels*. LA-4558-MS, Los Alamos Scientific Laboratory, Los Alamos, New Mexico.
- Healy, J. W., and J. J. Fuquay. 1959. "Wind Pickup of Radioactive Particles from the Ground." *Progress in Nuclear Energy*. Series XII, Health Physics Vol. I, Pergamon Press, New York.
- Higley, K. A., and D. L. Streng. 1988. *Use of a Monte Carlo Modeling Approach for Evaluating Risk and Environmental Compliance*. Presented at the Fourth Annual DOE Model Conference, Oak Ridge, Tennessee, October 3 - 7, 1988. PNL-SA-16062, Pacific Northwest Laboratory, Richland, Washington.
- Hinton, D., J. Sune, J. Suggs, and W. Barnard. 1986. *Inhalable Particulate Network Report: Operation and Data Summary (Mass Concentrations Only)*. Vol. 1-3, U.S. Environmental Protection Agency, Washington, D.C.
- International Atomic Energy Agency (IAEA). 1970. *Monitoring of Radioactive Contamination on Surfaces*. Technical Report Series No. 120, Vienna.
- International Atomic Energy Agency (IAEA). 1982. *Generic Models and Parameters for Assessing the Environmental Transfer of Radionuclides from Routine Releases*. Safety Series No. 57, Vienna.
- International Commission on Radiological Protection (ICRP). 1975. *Report of the Task Group on Reference Man*. ICRP Publication 23, Pergamon Press, New York.

References

International Commission on Radiological Protection (ICRP). 1977. *Recommendations of the International Commission on Radiological Protection*. ICRP Publication 26, Pergamon Press, New York.

International Commission on Radiological Protection (ICRP). 1979-1988. *Limits for Intakes of Radionuclides by Workers*. ICRP Publication 30, Parts 1-4 (and supplements), Vol. 2 (No. 3/4), Vol. 4 (No. 3/4), Vol. 6 (No. 2/3), and Vol. 19 (No. 4), Pergamon Press, New York.

International Commission on Radiological Protection (ICRP). 1983. *Radionuclide Transformations - Energy and Intensity of Emissions*. Vol. 11-13, ICRP Publication 38, Pergamon Press, New York.

International Commission on Radiological Protection (ICRP). 1986. *The Metabolism of Plutonium and Related Elements*. ICRP Publication 48, Vol. 16 (No. 2/3), Pergamon Press, New York.

International Union of Radioecologists (IUR). 1989. *Sixth Report of the Working Group on Soil-to-Plant Transfer Factors*. RIVM, Bilthoven, The Netherlands.

Isherwood, D. 1981. *Geosciences Data Base Handbook for Modeling a Nuclear Waste Repository*. NUREG/CR-0912, UCRL-52719, U.S. Nuclear Regulatory Commission, Washington, D.C.

Jensen, P. H. 1985. "Shielding Factors for Gamma Radiation from Activity Deposited on Structures and Ground Surfaces." *Nuc. Tech.* 68:29-39.

Kennedy, Jr., W. E., and B. A. Napier. 1983. *Allowable Residual Contamination Levels for Decommissioning Facilities in the 100 Areas of the Hanford Site*. PNL-4722, UNI-2522, Pacific Northwest Laboratory, Richland, Washington.

Kennedy, Jr., W. E., and R. A. Peloquin. 1990. *Residual Radioactive Contamination from Decommissioning: Technical Basis for Translating Contamination Levels to Annual Dose, Draft Report for Comment*. Draft NUREG/CR-5512, PNL-7212, U.S. Nuclear Regulatory Commission, Washington, D.C.

Kennedy, Jr., W. E., R. A. Peloquin, B. A. Napier, and S. M. Neuder. 1987. *Intruder Pathway Analysis for the Onsite Disposal of Radioactive Wastes: The ONSITE/MAXII Computer Program*. NUREG/CR-3620, PNL-4054, Supplement 2, U.S. Nuclear Regulatory Commission, Washington, D.C.

Kennedy, Jr., W. E., E. C. Watson, D. W. Murphy, B. J. Harrer, R. Harty, and J. M. Aldrich. 1981. *A Review of Removable Surface Contamination on Radioactive Materials Transportation Containers*. NUREG/CR-1859, PNL-3666, U.S. Nuclear Regulatory Commission, Washington, D.C.

Kocher, D.C. 1978. *Effects of Man's Residence Inside Building Structures on Radiation Doses from Routine Releases of Radionuclides to the Atmosphere*. ORNL/TM-6526, Oak Ridge National Laboratory, Oak Ridge, Tennessee.

Konikow, L. F., and J. D. Bredehoeft. 1978. "Computer Model of Two-Dimensional Solute Transport and Dispersion in Ground-Water." Book 7, Chapter C2 in *U.S. Geological Survey Techniques of Water Resources Investigations*. U.S. Geological Survey, Washington, D.C.

LaGoy, P. K. 1987. "Estimated Soil Ingestion Rates for Use in Risk Assessment." *Risk Analysis* 7(3):355-360.

Lepow, M. L., L. Bruckman, M. Gillette, S. Varkowitx, R. Robino, and J. Kapish. 1975. "Investigations into Sources of Lead in the Environment of Urban Children." *Environ. Res.* 10:414-426.

- Lillie, R. J. 1970. *Air Pollutants Affecting the Performance of Domestic Animals*. U.S. Department of Agriculture, Washington, D.C.
- MaGill, P. L., R. R. Holden, and C. Ackley, eds. 1956. *Air Pollution Handbook*. McGraw Hill, New York.
- Martin, W. E., and S. G. Bloom. 1980. "Nevada Applied Ecology Group Model for Estimating Plutonium Transport and Dose to Man." In *Transuranic Elements in the Environment*. DOE/TC-22800, U.S. Department of Energy, Washington, D.C.
- McKenzie, D. H., L. L. Cadwell, K. A. Gano, W. E. Kennedy, Jr., B. A. Napier, R. A. Peloquin, L. A. Prohammer, and M. A. Simmons. 1985. *Relevance of Biotic Pathways to the Long-Term Regulation of Nuclear Waste Disposal, Estimation of Radiation Dose to Man Resulting from Biotic Transport: The BIOPORT/MAXI 1 Software Package*. NUREG/CR-2675, PNL-4241, Vol. 5, U.S. Nuclear Regulatory Commission, Washington, D.C.
- McLeod, K. W., J. J. Alberts, D. C. Adriano, and J. E. Pinder III. 1984. "Plutonium Contents of Broadleaf Vegetable Crops Grown Near a Nuclear Fuel Chemical Separations Facility." *Health Physics* 46:261-267.
- McLeod, K. W., J. E. Pinder III, and J. R. Watts. 1984. "Contribution of a Nuclear Fuel Chemical Separations Facility to the Plutonium Content of a Tobacco Crop." *Health Physics* 46:1205-1211.
- Miller, D. W., ed. 1980. *Waste Disposal Effects on Ground Water*. Premier Press, Berkeley, California.
- Napier, B. A., R. A. Peloquin, D. L. Strenge, and J. V. Ramsdell. 1988. *Hanford Environmental Dosimetry Upgrade Project, GENII - the Hanford Environmental Radiation Dosimetry Software Package*. PNL-6584, Vol. 1-3, Pacific Northwest Laboratory, Richland, Washington.
- National Academy of Sciences (NAS). 1980. *Lead in the Human Environment*. National Academy Press, Washington, D.C.
- National Council on Radiation Protection and Measurements (NCRP). 1984. *Radiological Assessment: Predicting the Transport, Bioaccumulation, and Uptake by Man of Radionuclides Released to the Environment*. Report No. 76, Bethesda, Maryland.
- National Council on Radiation Protection and Measurements (NCRP). 1986. *Screening Techniques for Determining Compliance with Environmental Standards, Releases of Radionuclides to the Atmosphere*. Commentary No. 3, Bethesda, Maryland.
- Ng, Y. C., C. S. Colsher, and S. E. Thompson. 1982. *Transfer Coefficients for Assessing the Dose from Radionuclides in Meat and Eggs*. NUREG/CR-2976, U.S. Nuclear Regulatory Commission, Washington, D.C.
- Oak, H. D., G. M. Holter, W. E. Kennedy, Jr., and G. J. Konzek. 1980. *Technology, Safety and Costs of Decommissioning a Reference Boiling Water Power Station*. NUREG/CR-0672, U.S. Nuclear Regulatory Commission, Washington D.C.
- O'Neal, B. L., and C. E. Lee. 1990. *IMPACTS-BRC Version 2.0 Program Users Manual*. NUREG/CR-5517, U.S. Nuclear Regulatory Commission, Washington, D.C.

References

- Oztunali, O. I., G. C. Re, P. M. Moskowitz, E. D. Picazo, and C. J. Pitt. 1981. *Data Base for Radioactive Waste Management: Impacts Analyses Methodology Report*. NUREG/CR-1759, Vol. 3, U.S. Nuclear Regulatory Commission, Washington, D.C.
- Pao, E. M., K. H. Fleming, P. M. Guenther, and S. J. Mickle. 1985. *Foods Commonly Eaten by Individuals: Amounts Per Day and Per Eating Occasion*. Report No. 44, U.S. Department of Agriculture, Consumer Nutrition Division, Hyattsville, Maryland.
- Pinder, III, J. E. and K. W. McLeod. 1988. "Contaminant Transport in Agroecosystems Through Retention of Soil Particles on Plant Surfaces." *J. Environ. Qual.* 17:602-607.
- Pinder, III, J. E. and K. W. McLeod. 1989. "Mass Loading of Soil Particles on Plant Surfaces." *Health Physics* 57:935-942.
- Pinder, III, J. E., K. W. McLeod, D. C. Adriano, J. C. Corey, and A. L. Boni. 1990. "Atmospheric Deposition, Resuspension, and Root Uptake of Pu in Corn and Other Grain-Producing Agroecosystems Near a Nuclear Fuel Facility." *Health Physics* 59(6):853-867.
- Poston, T. M., and D. C. Klopfer. 1988. "Concentration Factors Used in the Assessment of Radiation Dose to Consumers of Fish: A Review of 27 Radionuclides." *Health Physics* 55:751-766.
- Rupp, E. M., F. L. Miller, and C. F. Baes III. 1980. "Some Results of Recent Surveys of Fish and Shellfish Consumption by Age and Region of U.S. Residents." *Health Physics* 39:165-175.
- Sayre, J. W., E. Charney, J. Vostal, and I. B. Pless. 1974. "House and Hand Dust as a Potential Source of Childhood Lead Exposure." *Am. J. of Dis. Chil.* 127:167-170.
- Schneider, K. J., and C. E. Jenkins. 1977. *Technology, Safety, and Costs of Decommissioning a Reference Nuclear Fuel Reprocessing Plant*. NUREG-0278, U.S. Nuclear Regulatory Commission, Washington, D.C.
- Sehmel, G. A. 1974. "Particle Resuspension from an Asphalt Road." *Atmosphere-Surface Exchange of Particulate and Gaseous Pollutants*. Conf-740921, U.S. Atomic Energy Agency, Washington, D.C.
- Sehmel, G. A. 1975. "Atmospheric Dust Size Distributions as a Function of Wind Speed." In *Pacific Northwest Laboratory Annual Report for 1974*, BNWL-1950-3, Pacific Northwest Laboratory, Richland, Washington.
- Sehmel, G. A. 1977a. *Transuranic and Tracer Simulant Resuspension*. BNWL-SA-6236, Pacific Northwest Laboratory, Richland, Washington.
- Sehmel, G. A. 1977b. *Radioactive Particle Resuspension Research Experiments on the Hanford Reservation*. BNWL-2081, Pacific Northwest Laboratory, Richland, Washington.
- Sehmel, G. A. 1980. "Particle Resuspension: A Review." *Environ. Int.* 4:107-127.
- Sehmel, G. A. 1984. "Deposition and Resuspension." In *Atmospheric Science and Power Production*. DOE/TIC-27601, U.S. Department of Energy, Washington, D.C.

- Sheppard, M. L., S. C. Sheppard, and B. D. Amiro. 1991. "Mobility and Plant Uptake of Inorganic ^{14}C and ^{14}C -Labelled PCB in Soils of High and Low Retention." *Health Physics* 61(4):481-492.
- Sheppard, M. L., and D. H. Thibault. 1990. "Default Soil Solid/Liquid Partition Coefficients, K_{ds}, for Four Major Soil Types: A Compendium." *Health Physics* 59 (4):471-478.
- Shinn, J. H., D. N. Homan, and C. B. Hofmann. 1986. *A Summary of Plutonium Aerosol Studies: Resuspension at the Nevada Test Site*. UCRL-90746, Lawrence Livermore National Laboratory, Livermore, California.
- Shinn, J. H., D. N. Homan, and W. L. Robinson. 1989. *Resuspension Studies at Bikini Atoll*. UCID-18538-Rev. 1, Lawrence Livermore National Laboratory, Livermore, California.
- Shor, R. W., C. F. Baes III, and R. D. Sharp. 1982. *Agricultural Production in the United States by County: A Compilation of Information from the 1974 Census of Agriculture for Use in Terrestrial Food Chain Transport and Assessment Models*. ORNL-5768, Oak Ridge National Laboratory, Oak Ridge, Tennessee.
- Simmons, J. R., G. S. Linsley, and J. A. Jones. 1979. *A General Model for the Transfer of Radioactive Materials in Terrestrial Food Chains*. U.S. National Radiological Protection Board, Report NRPB-R89, Washington, D.C.
- Sinclair, P. C. 1976. "Vertical Transport of Desert Particulates by Dust Devils and Clear Thermals." In *Atmosphere-Surface Exchange of Particulate and Gaseous Pollutants*. CONF-740921, U.S. Department of Energy, Richland, Washington.
- Smith, R. I., G. J. Konzek, and W. E. Kennedy, Jr. 1978. *Technology, Safety and Costs of Decommissioning a Reference Pressurized Water Power Station*. NUREG/CR-0130, U.S. Nuclear Regulatory Commission, Washington, D.C.
- Soldat, J. K., J. G. Droppo, Jr., W. H. Rickard, and L. G. Faust. 1973. *Assessment of the Environmental Impact of the Retrievable Surface Storage Facility*. BNWL-B-313, Pacific Northwest Laboratory, Richland, Washington.
- Soldat, J. K., and R. D. Harr. 1971. "Radiation Dose Model." In *HERMES - A Digital Computer Code for Estimating Regional Radiological Effects from the Nuclear Power Industry*, J. F. Fletcher and W. L. Dotson, eds. HEDL-TME-71-68, Hanford Engineering Development Laboratory, Richland, Washington.
- Stern, A. C., ed. 1968. *Air Pollution*. 2nd ed. Academic Press, New York.
- Stewart, K. 1964. "The Resuspension of Particulate Material from Surfaces." In *Proceedings of the Surface Contamination Symposium*. B. R. Fish ed. Pergamon Press, New York.
- Streng, D. L., T. J. Bander, and J. K. Soldat. 1987. *GASPAR II - Technical Reference and User Guide*. NUREG/CR-4653, PNL-5907, U.S. Nuclear Regulatory Commission, Washington, D.C.
- Streng, D. L., R. A. Peloquin, G. Whelan. 1986. *LADTAP II - Technical Reference and User Guide*. NUREG/CR-4013 (PNL-5270), U.S. Nuclear Regulatory Commission, Washington, D.C.
- Sumerling, T. J., N. J. Dodd, and H. Green. 1984. "The Transfer of ^{90}Sr and ^{137}Cs to Milk in a Dairy Herd Grazing Near a Major Nuclear Installation." *Sci. Total Environ.* 34:57-72.

References

- Thibault, D. H., M. I. Sheppard, and P. A. Smith. 1990. *A Critical Compilation and Review of Default Soil Solid/Liquid Partition Coefficients, K_d, for Use in Environmental Assessments*. AECL-10125, Atomic Energy of Canada Limited, Whiteshell Nuclear Research Establishment, Pinawa, Manitoba, Canada.
- Thorne, M. C. 1984. *ECOS: Values of Parameters to be Used for Domestic Animals*. ANS Report No. 372, Associated Nuclear Services, Epsom, Surrey, England, U.K.
- Thorton, I., and P. Abrahams. 1983. "Soil Ingestion - A Major Pathway of Heavy Metals into Livestock Grazing Contaminated Land." *The Science of the Total Environment* 28:287-291.
- Till, J. E., and H. R. Meyer, eds. 1983. *Radiological Assessment*. NUREG/CR-3332, ORNL-5968, U.S. Nuclear Regulatory Commission, Washington, D.C.
- Tracy, J. V. 1982. *Users Guide and Documentation for Adsorption and Decay Modifications to the USGS Solute Transport Model*. NUREG/CR-2502, U.S. Nuclear Regulatory Commission, Washington, D.C.
- U.S. Department of Agriculture (USDA). 1983. *Food Intakes: Individuals in 48 States, Year 1977 - 78 Nationwide Food Consumption Survey 1977 - 1978*. Report No. I-1, USDA, Consumer Nutrition Division, Hyattsville, Maryland.
- U.S. Department of Health, Education, and Welfare (HEW). 1969. *Air Quality Criteria for Particulate Matter*. HEW, Washington, D.C.
- U.S. Environmental Protection Agency (EPA). 1989. *Exposure Factors Handbook*. EPA/600/8-89/-43, EPA Office of Health and Environmental Assessment, Washington, D.C.
- U.S. Environmental Protection Agency (EPA). 1991. *Risk Assessment Guidance for Superfund Volume I: Human Health Evaluation Manual, Supplemental Guidance: Standard Default Exposure Factors*. OSWER Directive 9285.6-03 (March 25, 1991) Interim Final, EPA Office of Emergency and Remedial Response, Washington, D.C.
- U.S. Nuclear Regulatory Commission (NRC). 1974. *Termination of Operating Licenses for Nuclear Reactors*. Regulatory Guide 1.86, NRC, Washington, D.C.
- U.S. Nuclear Regulatory Commission (NRC). 1977. *Calculation of Annual Doses to Man From Routine Releases of Reactor Effluents for the Purpose of Evaluating Compliance with 10 CFR Part 50, Appendix I*. Regulatory Guide 1.109, Rev. 1, NRC, Washington, D.C.
- Van Wijnen, J. H., P. Clausing, and B. Brunekreef. 1990. "Estimated Soil Ingestion by Children." *Environmental Research* 51:147-62.
- Walter, S. D., A. J. Yankel, and I. H. Von Lindern. 1980. "Age-Specific Risk Factors for Lead Absorption in Children." *Archives of Environ. Health* 53(1):53-58.
- White, G. C., T. E. Hakonson, and A. J. Ahlquist. 1981. "Factors Affecting Radionuclide Availability to Vegetables Grown at Los Alamos." *J. Environ. Qual.* 10:294-299.
- Wilson, J. L., and P. J. Miller. 1979. "Two-Dimensional Plume in Uniform Groundwater Flow, Closure." *J. Hydraulics Division*, 105(HY12):1567-1570.

Appendix A

**NRC Staff and Technical Responses to Comments on NUREG/CR-5512 -
Residual Radioactive Contamination from Decommissioning:
Technical Basis for Translating Contamination Levels
to Annual Dose,
Draft Report for Comment - January 1990**

Appendix A

NRC Staff and Technical Responses to Comments on NUREG/CR-5512 - Residual Radioactive Contamination from Decommissioning: Technical Basis for Translating Contamination Levels to Annual Dose, Draft Report for Comment - January 1990

During January 1990, the Office of Nuclear Regulatory Research of the U.S. Nuclear Regulatory Commission (NRC) issued for public comment a draft report prepared by the Pacific Northwest Laboratory (PNL) entitled *Residual Radioactive Contamination From Decommissioning: Technical Basis for Translating Contamination Levels to Annual Dose*, NUREG/CR-5512 (Kennedy and Peloquin 1990). This appendix contains a summary of the comments received during the public comment period, with a description of the responses provided and the modifications that were made to the final report. Comments included are those from the six public comment letters received as well as those from NRC staff. Public comment letters are available from the NRC Public Document Room, Washington, D.C. 20555, telephone number 301-634-3273, under reference citation 55 FR 6137, February 21, 1990. Public commenters are listed in Table A.1. The comments have been organized in six major areas: 1) Policy Issues and Regulatory Perspective, 2) Measurements and Survey Considerations, 3) Textual Errors and Editorial Improvements, 4) Technical Considerations, 5) Model Verification, and 6) Other Issues. Of the 246 comments received, the majority (over 100 comments) came from the technical community regarding the pathway analysis, scenario descriptions, mathematical models, and dosimetric methods.

Table A.1 List of public commenters

Docket no.	Commenter
1	Fuel Cycle Facilities Forum
2	Nuclear Management and Resources Council (NUMARC)
3	Oak Ridge National Laboratory (ORNL)
4	Argonne National Laboratory (ANL)
5	Department of Energy (DOE)
6	Los Alamos National Laboratory (LANL)

A further breakdown of the technical comments has been provided in specific technical areas of concern. About 25 comments were received that provided background or general information and by their informational nature required no response. The following sections describe the general types of comments received in each area and provide specific summary questions and responses in the areas of greatest interest. In developing the summary questions, several related questions were often combined so that an overall response could be provided. The response under each comment indicates the nature of changes that were made in this final report as a result of the comment.

Several of the comments appeared to misunderstand the intended purpose of the generic screening levels (expressed as radioactivity or concentration thereof) and the modeling framework in the draft report. As of August 1992, generic radiological criteria for decommissioning have not been established by the NRC. However, for illustrative purposes one can hypothetically consider the case where such criteria could be related to annual dose. Then, under this hypothesis, application of generic screening levels can be illustrated with a flow diagram of a three-layered hierarchy for criteria that might be used for release after decontamination and decommissioning (Figure A.1). Continuing with this hypothesis in a general sense, the shaded area of Figure A.1, labeled "Generic Screening Levels," corresponds to the levels obtained by dividing an annual dose criterion in mrem TEDE/y by the appropriate dose conversion factors in the tables from Volume 2 of this report. This is the same hierarchy illustrated in the Foreword under "Hierarchy of Modeling Approaches." As also mentioned in the Foreword, the next stratum in the hierarchy applies the modeling framework contained in this final report to derive site-specific dose conversion factors--and, in turn, release levels. These site-specific derived levels are determined by inserting appropriately justified site-specific parameter values into the modeling analysis using the user-friendly software documented in Volume 2 of this report. Finally, the last stratum of release criteria is derived from technically defensible site-specific models, which incorporate site-specific parameter values and data. This last stratum is not generically applicable and is beyond the scope of this report. It should be noted that with adequate justification it is possible to obtain unrestricted use (i.e., release) from any of the three modeling strata.

A.1 Policy Issues and Regulatory Perspective

About 30 comments were received concerning various aspects of the NRC policy on residual radioactivity. NUREG/CR-5512 is only a part of a general information base being developed for use by the NRC for consideration of regulatory activities necessary to implement decommissioning of facilities, lands, and structures. Other studies are underway or have been completed (e.g., NUREG/CR-5849, "Manual for Conducting Radiological Surveys in Support of License Termination" [Berger 1992]). The results of these studies, in conjunction with the resolution of policy issues, will permit the development of appropriate regulations allowing the unrestricted use of, and termination of licenses for, decommissioned nuclear facilities.

Responses to additional summary comments are included below:

Comment 1: Collective dose needs to be discussed to assure that affected groups of individuals will not be subjected to unacceptably large doses.

Response: For purposes of the draft report, there was no consideration of collective dose. This was because the intent of the report was focused on individual dose conversion factors and the technical development of models and methods for translating contamination levels to dose for radionuclides in buildings or land.

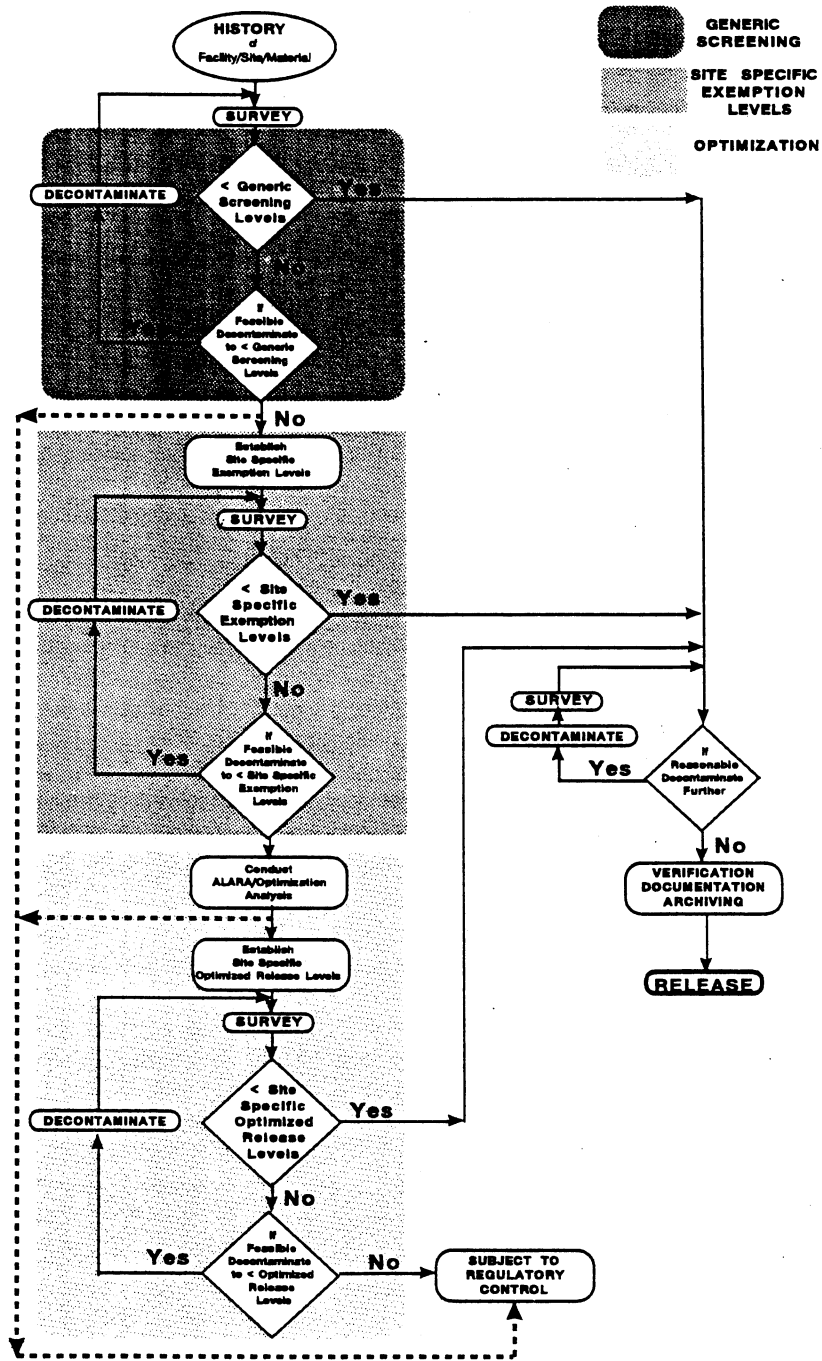

Figure A.1 Hypothetical flow diagram for release criteria

Appendix A

Comment 2: Is there some average number for acceptable dose that one can assign in some plausible manner?

Response: The scope of this report is limited to providing the technical basis and calculational methods for deriving dose conversion factors. Through an enhanced participatory rulemaking, the NRC will determine radiological criteria for decommissioning appropriate to protect both the public health and safety and the environment.

Comment 3: How do the recently modified risk conversion factors in the National Research Council's BIER V (1990) report affect the values shown in draft NUREG/CR-5512?

Response: There is no attempt to convert from dose to risk in the draft NUREG/CR-5512. No changes were made to the final report due to this comment.

Comment 4: Dose values like 5 $\mu\text{R}/\text{h}$ at 1 m are often quoted by NRC staff in relation to release criteria. In practice, NRC inspectors typically will place the meter a lot closer (sometimes in contact) with items being surveyed. Is there a way to look at the relationship between a reading at one meter and a contact dose reading for these release criteria?

Response: The value of 5 $\mu\text{R}/\text{h}$ at 1 m approximates 10 mrem/y for the external exposure pathway, assuming a 2000 h/y exposure period. However, direct measurement of the external exposure pathway does not account for the contributions to annual TEDE from the ingestion and inhalation pathways. The response to this comment is more appropriately a policy issue because the decision to allow direct measurements is not part of the technical basis found in NUREG/CR-5512 and references to direct measurements have been removed from the final report. However, as previously stated in the Foreword, a separate report (NUREG/CR-5849 [Berger 1992]) has been prepared to discuss survey methods and alternatives. Based on that report and the rulemaking on radiological criteria for decommissioning, guidance regarding appropriate measurement methods will be included in the release criteria.

Comment 5: Explain an apparent discrepancy with the 5 $\mu\text{R}/\text{h}$ release criteria. A conversion of 5 $\mu\text{R}/\text{h}$, with continuous exposure for 8760 h/y, gives a dose value of about 31 mrem/y, not 10 mrem/y.

Response: As stated in the previous response, the value of 5 $\mu\text{R}/\text{h}$ at 1 m approximates 10 mrem/y for the external exposure pathway, assuming a 2000 h/y exposure period. Implementation of direct measurements of external pathway exposures is beyond the scope of this report. Guidance will be provided in a Regulatory Guide.

Comment 6: How were values for radium in lands and the indoor radon aerosol derived?

Response: Values for radium in lands were calculated on the technical basis described in the report. No modeling was conducted for the indoor radon aerosol—on the basis that geological and architectural variations are so great that generic modeling is not feasible and that direct measurement of the indoor radon aerosol is preferred. A footnote will be included in the appropriate tables in Volume 2 to remind the user that the indoor radon aerosol has not been modeled in the calculations. Comment number 8 in Section A.4.4 also addresses indoor radon.

Comment 7: If annual dose limits other than 10 mrem/y are adopted, will the estimated concentration criteria simply scale, or is the calculation more complicated?

Response: The values in Volume 2 of NUREG/CR-5512 will show the dose conversion factors resulting from a unit concentration of radioactivity for residual contamination in buildings or lands. The level of residual radioactive contamination associated with any dose limit is a simple calculation; namely, divide the dose by the dose conversion factor to get the corresponding concentration or quantity of radioactivity. Thus, the dose conversion factors simply scale from one dose criterion to another. However, as of August 1992, radiological criteria for decommissioning have not been established, and they may or may not be expressed in terms of a dose criterion in the final form.

Comment 8: An explanation of why there are large differences in the derived contamination levels relating to 10 mrem/y needs to be developed to provide users an understanding of how a range of values by several orders of magnitude for different radionuclides could result.

Response: The range of levels is derived from the potential of each radionuclide to deliver dose through several pathways in the scenario analysis. This means that a combination of pathways is considered, not just external exposure, because the annual TEDE is used. The dose conversion factor values for inhalation or ingestion of alpha-emitters or beta-emitters for some scenarios are more limiting (i.e., unit concentrations result in similar doses). The relative radiotoxicity of a radionuclide is directly related to types and energies of their emissions as well as the dominant pathway of exposure.

Comment 9: When Regulatory Guide 1.86 (NRC 1974) was developed, the NRC found that limits set on the basis of dose alone resulted in some very large allowable concentrations. At that time, it was decided to put a cap or limit on the numbers because decontamination to lower levels is easy to implement (i.e., you don't have to live with 100 million dpm of tritium—you would clean it up!). A cap should be placed on the screening levels to add credibility to the overall effort.

Response: The technical basis document was developed in a consistent manner for all radionuclides. The decision whether to cap higher values for tritium, or to group similar radionuclides, or even to consider other special factors would be a policy decision beyond the intent of the technical basis report. As indicated in Figure A.1, as a matter of good practice the licensee should consider whether simple decontamination practices would be effective at levels below the release criteria, e.g., wiping a wall with a damp cloth. No changes were made to the final report due to this comment.

A.2 Measurements and Survey Considerations

About 12 detailed comments on draft NUREG/CR-5512 were submitted regarding various aspects of radiation detection. While there was some overlap in the comments, the primary concern expressed was whether the residual radionuclide concentrations derived would be detectable using current field-survey methods. Other commenters wanted to know if the scenario-specific dose conversion factors were to be applied as maximum or average values, how to estimate the radioactive decay period for compliance estimates, and whether building-surface contamination should be combined with soil contamination. The section contains a general summary of these comments with detailed responses and indicates changes made for the final document.

Comment 1: For many mixtures of radionuclides, there will be difficulties in verifying compliance with a fraction of the public dose limit, like 10 mrem/y, when using field instrumentation. Potential problems were cited

for mixtures of uranium using information from the Formerly Utilized Site Remedial Action Project (FUSRAP) program. Additionally, it may be impractical to accurately measure an external exposure rate increment from soil of less than 2 $\mu\text{R/h}$ when the range of natural background varies from about 5 to 10 $\mu\text{R/h}$. At other sites, variability in measurements may be as much (or more) than 10 mrem/y.

Response: Although radiation detection problems at low dose exposures are likely to be encountered, measures to ensure compliance are possible through the definition of adequate survey protocols. This may mean the use of laboratory analyses to establish environmental levels if direct measurements in the field are not reliable. No change was made to the final document because of this comment. However, because this is an important concern, a separate document, NUREG/CR-5849 (Berger 1992), has been developed concerning the design of radiation survey methods for residual radioactive contamination.

Comment 2: Calibration differences at low exposure rates may also make it difficult, at best, to draw intercomparisons between data measured with different instruments. This may mean that exposure rate measurements are reliable only in demonstrating that no statistical excess exists.

Response: Again, the role of external exposure rate measurements within a survey may only be of a confirmatory nature. Further consideration of instrument selection and survey protocol design for residual radioactivity has been developed and documented separately in NUREG/CR-5849 (Berger 1992). No change was made to the final document because of this comment.

Comment 3: There is a need to resolve some confusion regarding characterization of the concentration of radioactive materials at a site and verification of modeling methods.

Response: Characterization of the concentration of radioactive materials at a site consists of technically sound sampling of lands and structures with the appropriate instrumentation with the aim of using the data to summarize the character of the site. This procedure is described in the companion document on surveys and instrumentation that is under development. Model verification is a quality-assurance check that the modeling equations are applied and calculated accurately. The computer models and calculations in Volumes 2 and 3 of this document have been checked by hand calculations and comparisons with other modeling approaches have been made under strict quality-assurance procedures. No changes were made to the final report because of this comment.

Comment 4: For surface-contamination in buildings, the staff from Oak Ridge National Laboratory report a minimum alpha detection level of 3 cpm per 100 cm^2 . This level is sufficiently low so that detection of alpha surface contamination should pose no problem.

Response: Information on the proper choice of instrumentation and survey protocols is available (NUREG/CR-5849 [Berger 1992]). Radiation surveys conducted within buildings are significantly different from environmental surveys. However, at low dose rates there may be problems that require the careful choice of instrumentation and design of survey protocols for proper characterization. No change was made to the final report because of this comment.

Comment 5: The scenarios and models used attempt to estimate doses in a realistic manner but include a high degree of conservatism when the uncertainties are large. In the case of the external dose, measurements are probably faster than modeling and may provide a better estimation of long-term hazard.

- Response:** Site-specific analyses may be required when the simple screening approach fails. External measurements, if done in an appropriate manner, may provide a more accurate estimate of the overall dose from the external exposure pathway. However, external measurements need to be included with modeled estimates of dose from inhalation and ingestion to calculate the annual TEDE. The release criteria will address the potential role of external exposure measurements.
- Comment 6:** Provide an expanded discussion of the intent of the final survey and what a licensee must do to convince the NRC that the contamination levels or dose limits are met.
- Response:** A separate document, NUREG/CR-5849 (Berger 1992), has been developed to discuss potential survey methods and alternatives. The complexity of the procedures will depend on the nature of the source term and the characteristics of the site. For example, if a licensee dealing with sealed sources can verify that the integrity of the sources has not been breached, the verification of appropriate disposal of these sources may be sufficient to justify a simple survey. Other sites involving volume contamination in buildings or soils, with highly variable mixtures or intensities, may require sophisticated measurements and statistical analysis as part of the final survey. No major changes were made to this final report due to this comment.
- Comment 7:** Before the analysis can be evaluated, a reviewer must clearly understand how the "technical basis" is to be used. For example, are the calculated values averages over some unit area or are they maximum concentrations? At what decay time should the calculations be performed? Are the doses from the indoor surface contamination pathway to be combined with the soil pathway?
- Response:** Figure A.1 illustrates the role of the levels with respect to the hierarchy of criteria for release. Further consideration of how the values will be applied and related to radiation surveys will be developed and documented separately. This documentation will include a discussion of averaging for purposes of compliance determination. Generally, the calculations should be performed at the decay time considered for release of a site, unless additional ingrowth of radioactive decay progeny would increase the potential doses. Delayed entry of radionuclides into drinking water is also considered in the revised model. Finally, the only situation for which adding indoor surface contamination to outdoor soil contamination was considered was the drinking water scenario. For this scenario, an accounting of the total inventory should be made if the building could be demolished and rubble disposed of onsite (thus adding to the soil inventory). For more complicated situations, additional site-specific modeling may be warranted.
- Comment 8:** What about the use of smear samples for measuring removable contamination?
- Response:** Historically, a vital part of survey methods has been the use of smear samples to measure removable contamination. From a practical point of view, it makes sense to leave as little removable material on surfaces as possible; however, in a modeling analysis, future conditions regarding the removable fraction are difficult to determine. Given oxidative and other destructive processes and enough time, all materials deteriorate and contamination could become removable. Therefore, all contamination is considered removable.

A.3 Textual Errors and Editorial Improvements

More than 30 comments were submitted regarding various textual errors or suggesting editorial improvements to the final report. There was a good deal of overlap in the comments received on textual errors and internal inconsistencies, while the editorial comments varied. These comments were considered in developing the final report; however, because of the other significant modifications that have been made, it is not appropriate to provide a detailed response to each comment here. Instead, this section contains a general summary of the more significant comments and responses and indicates the types of changes that were made for the final document.

Comment 1: Several comments were received regarding units or unit conversions. Inconsistencies or errors in selected table headings, equations, or text were noted. For example, p. 2.45 was missing a unit for soil thickness (m); conversions in activity (pCi to Bq) or dose units (mrem to Sv) were questioned in a number of places; and the units used in some equations were in error.

Response: In preparing the final report, careful attention has been paid to the use of units. In addition to looking for typographical errors, dimensional analyses and programming verification of the basic equations were used to identify inconsistencies. Careful use of notation and an explanation of the derivation of constants have been added to Volume 1. As a result, numerous changes were made to properly account for the units of all equations, calculations, and tables.

Comment 2: Several comments were received regarding literature references. In some cases, additional references were suggested; in other cases, the use of references or the format of references was questioned.

Response: In preparing the final report, the authors consulted additional references in several areas, including existing pathway analysis models, regulations developed by other Federal agencies, and basic research information in the open literature. Additional references and their contributions to the revised analysis have been added to the text in several places.

Comment 3: Several comments regarding the format and content of the tables of TEDE conversion factors and scenario results were received. Some comments called for the use of expanded titles to eliminate the need for some of the footnotes, while other comments called for the creation of additional footnotes to better describe the calculations.

Response: Each of the comments on the format and content of the tables was considered and consistent modifications were made. Expanded titles and more complete footnotes have been developed to better communicate both the calculational process and the final results found in the tables in Volume 2.

Comment 4: One comment called for restructuring the document to include a separate section for each pathway. In this manner, additional details in the calculational procedure could be presented.

Response: The structure of the draft report was developed to provide a balance between the pathways and scenarios in the analysis. It is not only important to understand how the dose conversion factor is calculated for each pathway, but also to understand the relationship of each pathway to each scenario. Additional graphics have been added to Volume 1 to better describe the conceptual models, time frames, and connections among the basic elements of the modeling analysis. For clarity, the final report has been expanded into three volumes with greatly elaborated detail, as described in the Introduction to Volume 1.

Comment 5: All assumptions that go into analyses of various scenarios should be documented in a manner that will allow a licensee to ascertain if the generic treatment applies. This will also permit easy modifications when the generic treatment fails.

Response: The final report has a greatly expanded section on the assumptions and details of the modeling.

A.4 Technical Considerations

About 100 comments were received dealing with the technical details contained in draft NUREG/CR-5512. These comments have been sorted into seven categories: 1) Radioactive Chain Decay Methods, 2) External Dose Rate Calculations, 3) Water-Use and the Drinking Water Scenarios, 4) Models, 5) Data Selections, 6) Other Pathways and Scenarios, and 7) Airborne Dust-Loadings. This section summarizes the significant comments and responses and indicates the types of changes that were made in the final report for each category of technical comment.

A.4.1 Radioactive Chain Decay Methods

About 25 comments were submitted concerning the radioactive chain decay methods in draft NUREG/CR-5512. Many of the comments focused on the notation used for expressing decay chains in equilibrium or the practice of normalizing the dose conversion factors to a unit activity of the parent plus progeny. As a result of the comments, several changes were made to the final report. Several commenters provided specific examples of how to better express the results. The following general comments and responses summarize the significant points of concern raised during the public review and the modifications that have been made to the final report.

Comment 1: A number of commenters recommended against the approach used to provide unit dose conversion (and scenario) factors normalized to unit activity of parents plus progeny in equilibrium. The comments indicated that it would be confusing to users to include the activity of progeny with the parents and recommended providing all factors normalized to a unit of activity of parent only.

Response: All of the dose conversion factor presentations and calculations have been revised to be normalized to a unit of activity of the parent only (without consideration of the activity of progeny). Separate listings will be provided for progeny so that users of the report may calculate doses for any parent/progeny mixture not in secular equilibrium.

Comment 2: A number of commenters addressed the +I notation found in the draft version of NUREG/CR-5512. Most indicated that, in any dose assessment, it was reasonable to assume that short-lived progeny are in equilibrium with the parent, if all dose conversion factors are normalized to a unit activity of the parent.

Response: The notation for the entire report has been modified. For decay chains in secular equilibrium, the radiations included in the dose conversion factor for a parent are those associated with decay of the parent plus radiations from progeny. For the final report, secular equilibrium is defined for progeny having half-lives of less than 9 hours and also having half-lives less than 10% of the half-life of the parent. The use of +I notation is no longer necessary because the contributions from the progeny are always included (for external or internal dose conversion factors). For inhalation and ingestion dose conversion factors, the entries include radiations from all radionuclides contributing to internal dose, including progeny ingrowth, following intake of the parent (within the 50-year dose commitment

period). The inclusion of such contributions is defined precisely by recommendations of the International Commission on Radiological Protection (ICRP) in Publication 30 (1979-1988).

Comment 3: In addition to the +I notation, several commenters addressed the +D notation found in draft NUREG/CR-5512. The problem arises when the half-life of the progeny, although shorter than the parent, is still quite long. In this case, it would be tempting to include the progeny with the parent (as the +D notation indicated), but it would also be wrong for the majority of cases. A good example is $^{93}\text{Zr}+D$, where the parent is very long-lived and the progeny ($^{93\text{m}}\text{Nb}$) has a half-life of 16 years. It is not likely that the progeny will reach full equilibrium with the parent by the time decisions are needed on release of a decommissioned site. Eliminating the use of the +D notation forces users who make dose assessments to make conscious decisions about the state of equilibrium in radioactive decay chains.

Response: As with the +I notation, the notation for the entire report has been modified. The use of the +D notation is no longer needed because the radiations included in the dose conversion factor for a parent are those associated with decay of the parent plus radiations from progeny that are always in secular equilibrium. For all other cases, when the progeny are longer-lived than the parent or when the half-life of the progeny (although shorter than the parent) is still quite long, separate entries are provided for both the parent and the progeny. For the final report, secular equilibrium is assumed for progeny with half-lives that are both less than 9 hours and less than 10% of the half-life of the parent. For decay chains having two or more progeny radionuclides that reach secular equilibrium (constant ratio of activity as a function of time), a new +C (C for chain decay) entry is provided, giving dose conversion factors for the entire chain. These decay chains have a long-lived parent with progeny of varying shorter half-lives. This representation is of particular value for radionuclides in the four actinide decay series (neptunium, uranium, actinium, and thorium). The entry name in the table will include +C to indicate that all progeny in the chain are included in the dose conversion factors. An extended discussion has been provided in the final report summarizing the notation for entries in the final dose conversion factor tables.

Comment 4: Several commenters cited examples in which the calculation of dose conversion factors involving parent/progeny relationships were in error in draft NUREG/CR-5512. Examples included $^{93}\text{Zr}/^{93}\text{Nb}$, $^{90\text{m}}\text{Y}/^{90}\text{Y}$, and decay chains involving the U series.

Response: As part of the revision to the final report, a carefully defined Software Requirements Specification was developed as part of the internal quality-assurance documentation for the design of the software used to generate the scenario analysis for residual radioactive contamination. One of the requirements specifies the details of the radioactive decay chain analysis. A second requirement specifies the database supporting the calculations. These requirements were identified to ensure that the software performed all calculations in accordance with the modified approach to chain decay. Additional quality-assurance testing was conducted as part of the software development, including cases that used the comments and examples of cases in which the previous calculations contained errors.

Comment 5: Fuel cycle facilities downstream of a mine and mill process increasingly refined uranium (i.e., uranium separated from its progeny). Radioactive decay for the uranium chain would predict that a very small fraction of ^{226}Ra (the parent of ^{222}Rn) would be created relative to the parent uranium within 500 years, because of the long half-life of the uranium. Thus, residual contamination levels of refined uranium should not produce significant levels of ^{226}Ra in soils. This means that the use of dose conversion factors for the full chain is too conservative.

Response: The use of the entire uranium chain for specific situations involving refined uranium is not appropriate. For this reason, separate listings of parents and progeny are provided in the final document so that an accounting can be made of the non-secular equilibrium conditions that may exist at the time of decommissioning. In addition, the drinking water and residential scenarios are now time-dependent so that the peak dose conversion factor value and year can be determined for chain decay situations.

Comment 6: The draft version of NUREG/CR-5512 does not include ^{198}Au , although the use of this radionuclide is licensed by the NRC.

Response: This radionuclide has been added to the master radionuclide listing.

A.4.2 External Dose Rate Calculations

There were about 30 comments received during the public comment period on the external exposure pathway of draft NUREG/CR-5512. The comments questioned specific aspects of the calculational method, various aspects of the sensitivity study (in Appendix A of the draft), the need to calculate a deep dose equivalent, and the comparisons with other external dose rate calculations found in the literature. The following general comments and responses summarize the significant issues raised during the public review, and the modifications that have been included in the final report.

Comment 1: The external dose rate factors used in the draft report are provided for 1 cm in body tissue, referred to as the deep dose equivalent. A more appropriate method of calculation provides an organ-weighted effective dose equivalent, which can be directly added to the committed effective dose equivalent calculated for internal exposures from inhalation and ingestion of radionuclides.

Response: In this final report, a change has been made to use effective dose equivalent from external exposures, consistent with the method recommended by this commenter. The method for estimating external doses is discussed in Section 6.

Comment 2: Several commenters stated that a different method of producing external dose rate estimates should be developed. The commenters indicated that: 1) the ISOSHL code used for the draft was not documented well enough (a complete listing of the data library should be included), 2) a better description of the annihilation radiation calculations was needed, 3) accounting for bremsstrahlung was not needed, especially if the neutron dose is ignored, and 4) errors in the use of discrete energy groups as found in ISOSHL can occur (especially for low-energy photons).

Response: In response to these comments, the use of ISOSHL has been replaced with the use of a database of external dose rate factors contained in a Federal Guidance Report developed by the U.S. Environmental Protection Agency (Eckerman, Wolbarst, and Richardson 1988). Standardized source configurations from the Federal Guidance report are used in the scenario analysis for both surface contamination and contamination to an effective depth. The source geometries are either an infinite plane or an infinite slab. External doses were calculated for specific organs, taking into account the structure of the human body so that an effective dose equivalent is obtained. The effective dose equivalent (dose from external sources) can be added to the internal committed effective dose equivalent from ingestion and/or inhalation so that the TEDE is obtained.

Appendix A

- Comment 3:** There are many discrepancies between the external dose rate factors in the draft report and the factors found in DOE/EH-0070, *External Dose Rate Conversion Factors for Calculation of Dose to the Public* (DOE 1988).
- Response:** These discrepancies should be minimized in the final report because both listings of external dose rate factors provide the effective dose equivalent and both were developed by staff at Oak Ridge National Laboratory. Additional comparisons with other modeling approaches were made, as discussed in Volumes 2 and 3.
- Comment 4:** Several commenters discussed the potential role of backscatter in the external dose rate calculations. It was noted that the ISOSHLD code does not include backscatter calculations, and thus produces serious underestimation of the exposure. It was also noted that the source-receptor relationship for various work situations may require backscatter if the individual is located near a wall in a room.
- Response:** The generic nature of the calculations (i.e., one simple generic model used to estimate external doses for all scenarios) indicated that the method of calculation needed to be prudently conservative, without introducing additional modeling detail. Although backscatter may be important in some situations, so may the size of the room, the distribution of contamination (on the floor, walls, and ceiling), and the type of building or building materials encountered. It was determined that the simple model could not account for all possible levels of site-specific detail. Consequently, backscattering was not considered in this revised document.
- Comment 5:** Several commenters addressed the details found in Appendix A ("External Exposure Modeling Sensitivity Studies") of the January 1990 draft (Kennedy and Peloquin 1990). There was concern about using a tissue-equivalent cylinder of 5-cm radius to approximate whole body dose. The curves in Figure A.1 of the January 1990 draft were challenged as being incorrect (i.e., the energy-specific exposure rate curves should not be parallel for various source areas). One commenter indicated that omitting backscatter in the sensitivity studies (and dose conversion factors) would underestimate the potential dose, while a second commenter indicated that the use of an infinite plane source to model a contaminated room would lead to an overestimation of the dose. It was also noted that, for a generic study, it was not appropriate to develop more detailed methods for analysis of contaminated rooms.
- Response:** The original intent of Appendix A was to provide a discussion of the selection of source geometry configurations used in the scenario analysis. The 5-cm-radius sphere of tissue was a simple ISOSHLD representation that would indicate the relationship between point sources and small-to-large-radius disk sources. As a result of these comments and the degree of confusion that Appendix A appears to have caused, and because the method of external dose rate calculations has been revised, most of the information in that Appendix no longer applies and has been eliminated from the final report. Section 6 of Volume 1 of the final report includes an expanded discussion of the use of Federal Guidance Report external dose conversion factors and a discussion of the use of infinite plane or slab sources for the standard geometries.
- Comment 6:** One commenter indicated that the external dose conversion factors used in the draft report do not agree closely with those found in Regulatory Guide 1.109 (NRC 1977) and the database for 10 CFR 61 (within factors of 2 to 3), while a second commenter indicated that this range shows excellent agreement, given the different methods for estimating external exposure. A third commenter found the comparisons to be not particularly illuminating because similar methods have been used in all compilations developed in this country.

Response: It is recognized that different methods are used in the final report than in the draft; hence, such comparisons may not be technically correct. However, there is still merit in providing comparisons with the other pathway analysis studies found in the literature because such comparisons are relative benchmarks with which past evaluations may be re-examined. These comparisons will be revised and will be included in Volume 3.

Comment 7: There needs to be an expanded discussion, with additional detail, describing how the external dose conversion factors were calculated. Specifically, a more detailed comparison with the methods of Regulatory Guide 1.109 (NRC 1977) needs to be provided in the comparison so that the reader may perform hand calculations to verify the table values.

Response: A revised method of external dose rate estimates has been provided with an expanded discussion of how the Federal Guidance Report database (Eckerman and Ryman 1992) was applied in the final report. It is beyond the scope of this final report to fully describe the calculational approach used in Regulatory Guide 1.109 or any other literature source; however, a comparison of the final results is useful.

A.4.3 Water-Use Model and the Drinking Water Scenario

About 14 detailed comments were received concerning various aspects of the water-use model and the drinking water scenario found in the draft version of NUREG/CR-5512. The commenters questioned the need for the scenario, identified an error in the mathematical representation, and questioned the completeness of the scenarios concerning other uses of surface or ground water. The following comments and responses summarize the significant points of concern raised during the public review and highlight the modifications that have been included in the final report.

Comment 1: The authors have recognized the extremely uncertain nature of a generic analysis for the ground-water pathway; however, the generic analysis is so uncertain (when compared to any specific site) that it is meaningless for purposes of this report. Because of the uncertainty, this analysis and the drinking water scenario should be deleted from the report.

Response: The water-use model and the drinking water scenario are needed for completeness in the consideration of exposures for years beyond the time of decommissioning. In several places in the draft text, the authors have clearly recognized the limitations of a generic analysis and the fact that simple models oversimplify the actual conditions encountered at a particular site. The model and parameter values in this report are useful in establishing generic screening values. As illustrated in Figure A.1, the intent of the modeling exercise (as stated in Section 5.2 of the January 1990 draft NUREG/CR-5512) was to derive an aquifer concentration from residual radioactive materials in a conservative manner that would indicate when additional site data or modeling sophistication were warranted. The approach is not intended for broader applications. The model is constructed in a manner that will allow users to modify simple parameters (i.e., partition coefficients, infiltration rates, soil thickness, porosity, etc.) to better account for site-specific conditions. The option also exists within the NRC policy to use a much more sophisticated method for conducting a site-specific analysis, if needed. The final report contains an expanded discussion of the water-use model that clarifies the intent of the modeling analysis.

Comment 2: It would seem that the NRC should demand that licensees provide enough site-specific information to allow site-specific determinations of the importance of the drinking water pathway instead of attempting a generic analysis.

Appendix A

- Response:** The intent was to provide a conservative screening value that would eliminate the need for costly data collection and reporting when trivial conditions exist. Numerous licensees have sealed sources or short half-lived materials for which simple survey data (that are compared to generic inventory numbers) would be sufficient to prove that no problem exists. Also, see response to Comment 1 above. No change was made to the final report because of this comment.
- Comment 3:** The water-use model correctly uses the total inventory in the calculations; however, a clear purpose for the approach needs to be stated. The users need to be warned about the site-specific nature of potential ground-water contamination problems and that the analysis is based on a unit of activity (1 pCi and 1 Bq).
- Response:** An expanded discussion of the limitations of the water-use model has been provided to repeat the purpose of the approach and caution users about the uncertainties associated with the analysis. In Volume 2, the table of annual TEDE results has been modified to more clearly describe the units.
- Comment 4:** The water-use model assumes that elements are leached as determined by the partition coefficient, with no retardation, under conditions of continuous saturation. These are unlikely assumptions that should be replaced with more realistic ones.
- Response:** The water-use model was modified by the addition of an unsaturated zone with a depth of 1 m, to add realism and flexibility. Nonetheless, it is difficult to define a robust generic water-use model that does not contain conservative or unlikely assumptions compared with any real site or data. Again, the intent of the modeling exercise was to derive an aquifer concentration from residual radioactive materials in a conservative manner that would indicate when additional site data or modeling sophistication would be warranted. This approach is not intended for broader applications; however, it does permit the use of alternative parameters or models for conducting site-specific analyses. The NRC plans to continue to research ground-water modeling in an effort to provide alternatives to this approach.
- Comment 5:** The simple modeling of the ground water for use as drinking water ignores potential use of water for irrigation. The draft text states that this is done to avoid accounting for the inventory twice. If leaching of radionuclides is subtracted from the surface-soil concentration, a proper accounting of the inventory can be made. The residential scenario would also be more realistic if leaching is included in the modeling.
- Response:** Based on this comment and the review of the draft report, the residential scenario has been revised to include the use of ground water for irrigation and drinking, and the use of surface water for raising fish, as described in Section 5. The time-dependent ground-water radionuclide concentration is calculated using the three-box water-use model. This model includes simple leaching of radionuclides through soil and the unsaturated zone, with no retardation. The significant difference in the operation of the water-use model between the drinking water and residential scenarios is the annual flow assumed in the aquifer and surface pond (box 3). For the drinking water scenario, the flow is assumed to be the quantity of water used during a year by an individual for all purposes, including drinking, as discussed in Section 6. For the residential scenario, the flow is determined by the volume of water used for irrigation, plus the volume in the surface pond, plus the volume used by an individual for all other purposes (the same volume as used in the drinking water scenario). These changes were made to add realism to the generic scenario and to provide a more complete consideration of the potential behavior of radionuclides in soil.

Comment 6: A dimensional analysis of the ground-water equations in Appendix B indicates an error in the definition of λ_L . The correct equation should read:

$$\lambda_L = kI/(Hn) \quad (B.10)$$

Response: The generic water-use model used in the January 1990 draft report was a draft screening model provided by the National Council on Radiation Protection and Measurement (NCRP). It had been reviewed by the NCRP authors prior to publication of the January 1990 draft. A few weeks after publication, the error in the definition of λ_L was discovered in both the NCRP draft and our January 1990 draft. While the generic model has been replaced with the new three-box model, this formulation is still used, in a corrected form, for estimation of λ_L . Revised nomenclature has been used, as shown in Section 4.

Comment 7: The time-dependence of the TEDE should be accounted for in the modeling, especially the water-use modeling.

Response: For building scenarios, the annual TEDE is conservatively calculated on the basis of the exposure that occurs during the first year after license termination. For a screening analysis, this is an appropriate approximation because of the projected short life of a building compared to the time needed to reach equilibrium conditions for long-lived radionuclide chains. To account for the ingrowth of progeny from parent radionuclides in non-equilibrium chain decay, the user should perform a site-specific calculation based on the appropriate ratios of the radionuclides of interest. For residual radioactive contamination in soil, the revised water-use model has been calculated arbitrarily to determine a peak dose conversion factor up to 10,000 years. The credibility of model predictions for the distant future is quite low. The modeling assumptions concerning the physics and chemistry of the land, water, and carrier of the radionuclides, as well as assumptions of climatic stability, are associated with uncertainties that become greatly increased in the context of even a few hundred years. However, it should be recalled that only the long-lived radionuclides persist in these long time-frames, and that the levels of residual radioactive contamination of the long-lived radionuclides considered here are probably comparable to natural background.

Comment 8: At the bottom of page 2.34, there is a potentially misleading statement regarding the EPA's drinking water standards. The dose limit of 4 mrem for whole body or any organ in the interim drinking water standards applies only to man-made, beta/gamma-emitting radionuclides. In particular, the present drinking water standard of 5 pCi/L for radium and 15 pCi/L for all alpha-emitters, exclusive of uranium and radon, do not correspond to annual doses of 4 mrem. Thus, it is potentially misleading to present similar results for alpha and beta/gamma-emitting radionuclides in Tables 2.4 and 3.4. This mistake appears more explicitly on page 5.5.

Response: The dose conversion factors in Sections 2 and 3 are needed independent of doing a comparison with the EPA drinking water standards. Clearly, this comment is correct and a modified discussion is needed. The text in Sections 4 and 7 has been appropriately modified.

Comment 9: The 2-L/d drinking water consumption rate is too high. The EPA Office of Radiation Programs currently is using a value of 1.4 L/d for the drinking water scenario.

Response: The 2-L/d drinking rate may be a high value for use in a site-specific analysis. However, the intent in this scenario is to conservatively model drinking water consumption and provide a generic evaluation that can be used to determine when a more site-specific analysis should be performed. While the general intent of the scenario analysis in the document is to provide a prudently conservative estimate of the potential radiation doses, the wide range of variables and parameters to model has compelled a relatively conservative approach for the drinking water scenario and the water-use modeling. An expanded discussion has been added to explain the rationale for this scenario. In addition, the 1.4-L/d value is for an average individual and may not provide a prudently conservative analysis.

Comment 10: Paragraph 2 on page B.14 states that modified annual TEDE factors can be obtained by simply multiplying the TEDE factor in Table 3.4 by the modified parametric value and then dividing by the previously assumed parameter value. This is incorrect because the TEDE factors do not have linear relationships with most of the parameters listed in Equations (B.9) and (B.10).

Response: The paragraph and concepts have been modified appropriately based on this comment.

Comment 11: What assurance is there that the drinking water scenario is sufficiently conservative that it won't give a "false positive" (or low dose) reading?

Response: The water-use model has been extensively reviewed by both PNL and NRC geohydrologists. After an extensive literature search, the authors selected a set of parameter values for the calculations consistent with the prudently conservative approach. As mentioned above, the doses were calculated for an arbitrary period of up to 10,000 years. While it is possible that a scenario could be developed that would result in higher doses, it is assumed that the modeling and parameter selection are sufficiently conservative and will result in appropriate screening values for all but highly unlikely cases. In addition, the scenario considered an individual who consumes 2 L/d of water from the ground-water source. Several commenters held that a more reasonable consumption rate would be about 1 to 1.5 L/d. Based on this (and other) comments, the discussion of the water-use model and the drinking water scenario were expanded appropriately.

A.4.4 Models

About 20 comments were received on the details of the pathway analysis models used in the draft NUREG/CR-5512. The comments included concerns over the use of specific data or assumptions, details about the surface contamination conditions in the building occupancy scenario, accommodation of sources below the top 15 cm of soil, and the need for models describing other situations. The following comments and responses summarize the significant issues raised during the public review, and the modifications that have been made to the final report.

Comment 1: In general, the screening approach is difficult to apply when the many site-specific variables are considered. Screening levels, depending on the scenarios selected and parameters used, can be extremely conservative for many applications and radionuclides; but they can also result in underestimates of dose in selected cases. Site-specific modeling forces the users to consider the major parameters and allows flexibility of site-specific analysis that is easily verified by the regulators.

Response: The screening approach was selected because there are numerous licensees that handle rather small quantities of materials and have relatively trivial problems. These sites may not have the resources to conduct site-specific analyses and should not be required to do so. For more sites that do not meet the screening levels, site-specific applications derived within the modeling framework of this report may

be used; or more detailed models and data can be applied. It is difficult to predict in advance whether a generic modeling analysis will produce a more or less conservative result than a site-specific analysis. However, by using prudently conservative assumptions and data selections, it is unlikely that the doses for many sites will be underestimated. This approach has not been changed in the final report.

- Comment 2:** The draft report claims that the purpose is to calculate the likely radiation doses to average individuals. This is a general philosophy of dose assessment that should be endorsed. Too often decisions are made on the basis of worst-case estimates of dose, which have virtually no chance of being experienced by any individuals.
- Response:** The final report continues to be based on a prudently conservative analysis of the dose to average, not maximally, exposed individuals. No changes have been made to the text because of this comment.
- Comment 3:** It is important to emphasize the objective of the modeling exercise. By selecting prudently conservative modeling assumptions, instead of worst case, the doses may be underestimates for some situations.
- Response:** The section describing the intent of the modeling analysis was reviewed and expanded. For example, it is not reasonable to expect that all structures will become residences (e.g., reactor containment buildings). However, many could continue with some kind of laboratory or industrial application (e.g., laboratory space at a university). Discussions of the study basis and the modeling approach were reviewed and expanded appropriately.
- Comment 4:** It is difficult to interpret the methodology and data well enough to recreate the effective dose equivalent factors in the draft report using the GENII system. A clear explanation of how the calculations were performed is needed.
- Response:** For the final report, a careful analysis of the models, data, and calculational methods was performed and the use of the GENII software was discontinued. As a result, a software requirements specification was developed as part of the quality-assurance process of establishing a new computer code. This specification serves as the basis of a separate user-friendly computer program contained in Volume 2. This computer program can be used to recreate the scenarios and values found in this final document and produce dose conversion factor results for any mixture of radionuclides. The software also allows the user to make simple changes to the scenarios and data to better fit a simple site. Furthermore, all equations and parameter values necessary to hand-calculate annual TEDEs are provided in Volume 1 of this report.
- Comment 5:** The inhalation and secondary ingestion models used in the building occupancy (surface activity) scenario contain errors in converting from surface activity to mass activity. The models for these pathways need to be corrected and revised calculations need to be performed.
- Response:** A careful dimensional analysis was conducted, and the errors were identified and corrected for the final report. In summary, to convert from surface activity to mass activity in air for the building occupancy scenario, a resuspension factor of 10^{-6} m^{-1} is used. To convert from loose surface activity to mass activity for ingestion, an ingestion rate of $10^{-4} \text{ m}^2/\text{h}$ is used.
- Comment 6:** The residential surface-soil scenario is of limited use for sites with contamination or wastes buried deeper than 15 cm. Accommodation of sources of radioactivity deeper than 15 cm is needed in the models.

Appendix A

- Response:** The intent of the basic analysis is to provide generic screening levels and the modeling framework for deriving site-specific levels. These screening levels will aid the identification of cases where more detailed site-specific analyses are warranted. Clearly, for sites with subsurface sources, additional modeling detail may be needed to determine compliance. Also, the models are intended for simple surface-soil contamination cases and not onsite waste disposal or residual contamination within 1 m of the saturated zone, where other more appropriate performance assessment models and data sets are needed.
- Comment 7:** Inhalation dose conversion factors should be supplied for each solubility class, and ingestion dose conversion factors should be supplied for each f_1 value provided by the ICRP.
- Response:** The base-line calculations in the final document are made using assumptions about the inhalation solubility and f_1 values that will produce limiting results because the intent is to provide a screening analysis. The initial user-friendly computer software package developed to support this document will be done in the same manner. Future enhancements to the software will consider expanding the flexibility of the code to allow users to modify the inhalation solubility and f_1 selections to match known conditions.
- Comment 8:** One commenter indicated that the indoor radon aerosol should be considered for residual uranium and thorium in building materials because in many cases the radon will be the limiting pathway for uranium and thorium contamination. A second commenter stated that a generic model for the indoor radon aerosol would produce uncertain results because the design of a future building and its ventilation would be entirely conjectural.
- Response:** The NRC believes that it is more practical in terms of accuracy and economics to appropriately measure the indoor radon aerosol than to model it. The broad range of geological and architectural environments would lead to generic indoor radon models that would be extremely conservative for a large fraction of cases. The NRC will include criteria for indoor radon for measurements in the interim criteria for unrestricted release. No changes were made to the modeling approach because of this comment.
- Comment 9:** Equation (2.5) on page 2.43 of the draft presents a rather formidable-looking model for estimating the concentration of radionuclides in vegetation. In particular, the distinction of the last two terms seems unnecessary for a generic modeling exercise.
- Response:** This modeling approach for the residential scenario using this equation has been revised for the final report, eliminating the contribution from the last term (uptake from deep layers of soil). The revised approach accounts for uptake by roots from soil; deposition of resuspended soil on leaves; deposition and uptake of irrigation water by plants; uptake from plants, soil, and water by animals; and uptake of water, soil, plant crops, animal products, fish, soil, and air by man. A discussion of the modified approach for the residential scenario is found in Section 5.
- Comment 10:** If the inhalation rate is included in the dose conversion factor listed in Table 2.2, then the text must be appropriately modified.
- Response:** The inhalation rate is included as a separate parameter that may vary in the analysis for each scenario. The dose conversion factors are taken directly from Eckerman, Wolbarst, and Richardson (1988) in units of dose per unit intake. The text has been carefully reviewed and appropriately modified.

Comment 11: The value of zero for soil uptake for ^3H and ^{14}C should be verified and the specific form of ^3H should be stated.

Response: The models have been modified to include uptake of ^3H and ^{14}C from soil, as discussed in Appendices C and D. The ^3H is assumed to be HTO.

A.4.5 Data Selections

Seven comments on draft NUREG/CR-5512 were received dealing with the details of data or parameter selections supporting the modeling analysis. Some commenters generally questioned the overly conservative nature of specific data or parameter selections, while others requested a more conservative approach in selected areas. The following general comments and responses summarize the significant issues raised during the public review, and the modifications that have been made to the final report.

Comment 1: Several commenters stated that parameters were selected to provide a reasonable (not worst-case) estimate of the radiation dose conversion factor to an average member of a population. However, many of the assumptions and data used are not reasonable and represent the worst case. For example, it is assumed that the entire inventory of radionuclides will go into drinking water; there is no retardation in radionuclide transport in ground-water systems; and in some cases maximum individual consumption rates versus average consumption rates are used. These assumptions and data selections are extremely conservative and unreasonable.

Response: As discussed in Section 6 of the final report, an attempt has been made to identify the potential range for all data or parameter values, and to select parameter values within (not at the extreme) of these ranges. The notable exception is the drinking water pathway, where a simple method of estimating the ground-water concentration (ignoring retardation), combined with 2-L/d consumption of drinking water, is used. The major difference for this pathway between the residential and drinking water scenarios is the volume of water in the aquifer used to estimate the water concentration (i.e., because of irrigation and surface water, the residential scenario requires more water and thus provides more dilution for the radionuclides). Because less dilution is used in the drinking water scenario, the results will be more conservative than the drinking water pathway in the residential scenario. The results of this scenario provide a basis for determining when additional site-specific details or modeling are needed. Volume 1 of the final report contains an expanded discussion of the water-use model and the intent of the drinking water scenario. Because the other assumptions and parameters are within their potential ranges defined by literature values (as discussed in Section 6), no other changes have been made to the final report.

Comment 2: The choice of input parameters generally provides assurance that a conservative analysis has been conducted so that the dose limits are never exceeded. A sensitivity study needs to be conducted to assure that the estimates are conservative.

Response: The basic premise of the entire modeling analysis is to perform a prudently conservative analysis, not a worst-case analysis. The reason for this approach is that the calculated dose conversion factors are expected to be reasonably bounding in the large majority of cases. The discussion of the study basis and the modeling approach were reviewed and expanded appropriately.

Comment 3: The choice of shielding factors for the indoor residence part of the residential scenario, as discussed at the top of page 3.24 of the draft, is somewhat subjective. The most important variable is whether

shielding inside a single-family house is considered or whether the structure is more substantial (i.e., a school, factory, apartment, or office building). From the literature, a higher shielding factor of 0.7 (instead of 0.33) would be reasonable for this analysis.

Response: The choice of a shielding factor for the indoor-exposure conditions in the residential scenario is indeed somewhat subjective. As explained in the draft text, the range of potential shielding factors in the literature is from about 0.2 to 0.6, with the majority of data within a range of 0.02 to 0.4. The choice of a factor as high as 0.7 exceeds the range identified in the literature. For this reason, no change has been made to the residential-scenario indoor-shielding factor for the final report.

Comment 4 The leach-rate factors from Oztunali et al. (1981) refer to low-level radioactive wastes and may not be applicable for other types of wastes, including contaminated soils.

Response: Leach-rate factors and other information pertaining to the ground-water pathway can vary over a wide range, depending on site- and radionuclide-specific conditions. As discussed in Section 4, the purpose of the water-use model was to help determine which cases pose a trivial potential for ground-water contamination and which cases need to be further evaluated. The leach-rate values found in recent literature or derived using the soil-to-plant ratios (as discussed in Section 6) have been used instead of those found in Oztunali et al. (1981).

Comment 5: A better description of the solubility of radionuclides for the ingestion and inhalation pathways needs to be developed for the residential scenario. Was the most conservative solubility (i.e., the one leading to the largest radiation dose) used for each pathway for conservatism, even though it is chemically contradictory to model the same radionuclide as both soluble and insoluble simultaneously?

Response: An expanded discussion of the inhalation solubility classes and the f_1 factors has been provided for the final text. In general, the worst-case solubility has been assumed for the inhalation and ingestion pathways for the dose estimates using information found in EPA Federal Guidance Report No. 11 (Eckerman, Wolbarst, and Richardson 1988), even though this may seem contradictory. The exception is for plutonium, where a solubility class and uptake fraction more representative of environmental plutonium is used. The objective of this report is to derive generic screening levels as opposed to providing a precise kinetic model. This prudently conservative approach is intended to compensate for large uncertainties in the knowledge of the long-term interactions between the environment and radionuclides--either alone or in a spectrum of chemical carriers. For sites where the detailed environmental chemistry of specific elements is well known, future enhancements to the user-friendly software, described in Volume 2, will allow the user to specify the inhalation class and f_1 . No change beyond a modified discussion has been made to the final document.

Comment 6: The external dose rate conversion factors listed in Table 2.1 of the draft were converted from data in Table D.4 using an apparent soil density of 2.42 g/cm^3 . This density is too high for soils.

Response: In the January 1990 draft, the density of concrete was assumed to be 2.4 g/cm^3 . In the revised report, the soil density used in the calculations is 1.625 g/cm^3 (using the number of significant figures provided in Eckerman, Wolbarst, and Richardson 1988). The software design requirements were written to include this value in the modified method of determining external radiation exposures, and the text has been revised.

A.4.6 Other Pathways and Scenarios

There were 10 comments on draft NUREG/CR-5512 that involved other potential radiation exposure pathways or scenarios. The comments indicated that water pathways (including irrigation of agricultural land and ingestion of foods harvested from aquatic environments) should be included; the comments also encouraged inclusion of indoor radon exposure pathways in addition to a more detailed discussion of intruder events. The following comments and responses summarize the significant points raised during the public review and the modifications that have been made to the final report.

- Comment 1:** Several commenters specifically addressed potential water pathways that were not considered in the draft report. These included irrigation of land using contaminated ground water and ingestion of aquatic foods from surface streams potentially contaminated by surface runoff. One commenter indicated that this omission would make the data in the tables of the report of limited use, while another indicated that omission of the water pathways was justified because these pathways are site-specific.
- Response:** The pathways included in the generic analysis were those directly associated with exposure to contaminated soil sites. As previously noted, the residential scenario was modified to include use of ground water for drinking and irrigation and ingestion of fish from a surface pond. Surface runoff was assumed to be a secondary pathway in a generic analysis because it relies too strongly on site-specific conditions and requires processes that result in additional dilution before exposure can occur at a distance from the contaminated site. It is recognized that this pathway may be important for very large sites and for acute (flash flood) events at arid sites; however, a complete analysis would require a more detailed set of models, with the inclusion of additional data that may not be representative of a variety of generic situations. A revised description of the basis for the modeling has been included, but no other modifications have been made to the final report.
- Comment 2:** A potential pathway of importance that was omitted is direct ingestion of contaminated soil. This can be an important pathway for exposures of children who are prone to eat a lot of dirt while playing outdoors; however, it is hard to include in an analysis of the potential dose to adults. There are radionuclides for which direct ingestion of soil may play a role. This is particularly the case for radionuclides for which the root uptake factor from soil to plants may be very low. This pathway should be included for adults only in conjunction with ingestion of foods contaminated via root uptake.
- Response:** Children who eat contaminated soil do not constitute an appropriate critical population for the purposes of developing generic screening criteria. In recognition of the potential importance of this pathway, secondary ingestion of removable contamination was included in the building renovation and building occupancy scenarios, and soil deposition on plant surfaces after resuspension or irrigation was included in the residential scenario. The final report has been modified to include secondary ingestion of soil by an adult (using a lower ingestion) and by animals. The inclusion of soil ingestion is supported by an expanded review of the literature. The scenario descriptions were modified to better explain the rationale, but no modifications were made to the scenario analysis.
- Comment 3:** Two commenters referred to contamination on food crops by mechanisms other than root uptake. The first indicated that lack of rain-drop splash may produce nonconservative answers for some elements like cesium. A second commenter indicated removal of radionuclides on plant surfaces (deposited from radionuclides in soil resuspended in the air) should be included to reduce the doses from ingestion.

Response: For the food pathway within the residential scenario, the crops are assumed to be contaminated by both root uptake and deposition of radionuclides in irrigation water or in soils that are resuspended. Washing of produce to cause removal of some of the deposited material on the surface was not assumed. In this manner, the analysis was designed to compensate for the potential ingestion of material on plant surfaces, without adding deposition or removal mechanisms. In addition, secondary ingestion of soil by adults has been added to compensate for not including rain-drop splash. The scenario descriptions were modified to better explain the rationale, and the inclusion of the soil-ingestion pathway was made to further bound the potential effect of rain-drop splash.

Comment 4: The report should provide more detailed discussion on how to account for intruder events in performing dose assessments.

Response: The concept of intruders applies to sites that are still under regulatory control. A classic example is for licensed low-level-waste disposal sites. Intruder analyses can occur either during or after a period of institutional control. For sites containing residual radioactivity, the concept of an intruder is difficult to define since the release is intended for unrestricted use by any person, for all times. The discussion of scenario selection was expanded for the final draft, but no modifications were made to the scenario analysis specifically to address intruders.

A.4.7 Airborne Dust-Loadings

As a result of the public review of draft NUREG/CR-5512, 10 comments were received concerning the choice of airborne dust-loadings in the scenario analysis. The comments included concerns about sources of data, the potential use of a respirable fraction to reduce the effective air concentrations, individual data selections for indoor and outdoor dust-loadings, and the potential relationship between resuspended dust- and mass-loading models. The following comments and responses summarize both the significant issues raised during the public review and the modifications that have been made to the final report.

Comment 1: One commenter generally questioned the determination of dust-loadings from the literature, requesting an explanation of why different indoor dust-loadings were assumed for the building occupancy and residential scenarios. In some cases, the commenter noted, although the values seem reasonable when compared to the reference by Anspaugh et al. (1974), the supporting justification does not.

Response: The discussion of dust-loadings found in Section 6 has been revised to consider additional literature sources. The conclusions of Anspaugh et al. (1974) were reviewed as part of this revised discussion. It was assumed that the building occupancy scenario would include both office buildings and buildings used for light industrial activities; thus, a higher dust-loading than just for the residential scenario was used. The revised discussion in Section 6 provides an expanded rationale for the selection of dust-loadings; however, no other modifications were made to the report based on this comment.

Comment 2: The amounts of suspended dust in air assumed in exposure scenarios are reasonably conservative; dust-loadings three times higher than those used would be unrealistically high. However, all dust-loadings use a respirable fraction of 1.0. Literature values report that only about 30% of the suspended dust would be in the respirable range below 10 μm . All inhaled dust concentrations should be reduced to about 0.3 of the values used to account for the respirable fraction.

Response: The respirable fraction of airborne dust is highly variable (but seldom 1.0) and will depend on many factors. The mass-loading approach for estimating airborne dust concentrations was selected because

of its ease of application and because it required fewer assumptions and modeling steps than other methods. Variability in the dust-loading is accounted for by assuming a single average mass-loading factor for the duration of similar activities during the scenario. Dust-loadings were assigned within the expected range of values and a respirable fraction of 1.0 was assumed to provide conservatism. A discussion of the selection of mass-loading factors has been revised; however, no other change has been made to the final document because of this comment.

Comment 3: The indoor dust-loading was assumed to be 10% of the average value outdoors. While the indoor level in an undisturbed house may be less because of the availability of surfaces onto which airborne dust may deposit, human activity in the house (e.g., vacuuming or sitting in padded chairs) may increase indoor dust-loadings. An increase by a factor of two to five in the airborne dust-loading would be appropriate.

Response: The indoor dust-loading was assumed to be equal to the previously reported EPA value for indoor dust shown in their threshold limit values (TLVs). This value is within the range of values that appear in the literature shown in the discussion in Section 6. For the residential scenario, an additional source of indoor airborne dust has been added from resuspended soil tracked indoors. Because the intent of the analysis is to provide a prudently conservative (not worst-case) analysis of the potential dose, no changes to the assumed indoor dust-loading have been made for the final report. An expanded discussion of the selection of dust-loadings, including additional literature values, is included in Section 6.

Comment 4: One commenter asked if it was reasonable that gardening will be five times as dusty as the ambient outdoor air, while a second commenter noted that higher dust concentrations while gardening seemed reasonable. A third commenter suggested that all dust values be rounded up to the nearest order of magnitude.

Response: The expanded discussion of potential dust-loadings in Section 6 discusses the rationale for assuming an elevated dust-loading while gardening. Because the values selected are within the potential ranges for dust-loadings associated with the activities defined for the scenarios, no changes are made to the data selections.

Comment 5: The consideration of only respirable dust for dosimetric purposes makes sense for determining lung dose. To best determine the effective dose equivalent, however, the non-respirable particle sizes should be considered because they will contribute to the overall effective dose.

Response: The ICRP task group's lung model, used in the estimation of radiation doses from inhalation, does account for materials that are removed from the nose and shallow lung compartments and then transferred to the stomach. In addition, all of the scenarios defined in the generic analysis account for ingestion dose, either through secondary ingestion or direct ingestion of food products, drinking water, or soil. Ingestion of large-particle (non-respirable) material in the air concentration, beyond the normal operation of the ICRP lung model, was not included in the final report. However, it is believed that the assumption that the respirable fraction is 1.0 is sufficiently conservative to account for the dose attributable to ingested particles.

Comment 6: The conclusions of Anspaugh et al. (1974) are not used in Appendix B of the draft, even though a mass-loading model is used. The effort to fit the mass-loading model to the data on resuspension factors seems rather weak, given the wide range of resuspension factors reported in the literature.

Appendix A

Perhaps it would make more sense to simply use mass-loading factors from the literature and eliminate the discussion of resuspension factors.

Response: Part of the reason for including a discussion of resuspension models is to recognize that they may be used as an alternative to the methods used in this analysis. Based on an expanded literature survey of potential dust-loading information, an expanded discussion has been included in Section 6; however, no modifications have been made to the data selections or dose conversion factor analysis.

Comment 7: For the building renovation scenario, an average atmospheric dust-loading of 10^{-4} g/m³ was assumed. According to the paper by Anspaugh et al. (1974), this dust-loading corresponds to the average background value outdoors. Dust-loadings during building renovation could be considerably greater than the average dust-loading outdoors--this means that the potential doses for this scenario may be underestimated.

Response: Although the short-term dust-loadings may be higher, the intent was to select an average value that would be appropriate for the entire 500 hours of building renovation. The indoor dust-loading would be controlled by a number of factors, including the type and effectiveness of the building ventilation system. For this reason, no changes have been made to the assumed dust-loading for the building renovation scenario for the final report. No changes were made to the final report based on this comment.

Comment 8: Does the EPA have standards for residential surface soils indoors and air concentrations for leaf deposition as shown in Table 3.5?

Response: A careful review of Table 3.5 of the draft showed two typographical errors involving dust-loadings. The first was the yardwork dust value shown for the residential scenario. The table shows an incorrect value of 1×10^{-5} g/m³. The correct value is 1×10^{-4} g/m³. The second error was an air-concentrations value of 5×10^{-5} g/m³ from air-to-leaf disposition in the residential scenario (Table 3.5). The correct value for this parameter is 1×10^{-4} g/m³, the same value as used for yardwork dust.

A.5 Model Verification

A total of 16 comments were submitted regarding verification of the model analysis supporting draft NUREG/CR-5512. The commenters requested expanded documentation of computer model intercomparisons and provided feedback on the initial comparisons of model results that were based on the draft and made independently based on the draft. Most of the commenters either requested a model comparison study with the RESRAD computer code developed by the U.S. Department of Energy (DOE) or reported on initial comparison efforts using the RESRAD computer code. The following comments and responses summarize the significant issues raised during the public review, and the modifications that have been made to the final report.

Comment 1: Provide a description of how the models were verified by comparisons with other computer codes and with experimental data correlating contamination levels with external dose.

Response: Attempts to verify operation of the models with hand calculations and comparisons with other modeling studies were made and documented in several places in the draft report. These included comparisons of the basic pathway dose conversion factors and comparisons of the scenario results. For the final report, hand calculations have been repeated under strict quality-assurance procedures as

described in an internal software validation, verification, and testing plan. The quality-assurance procedures included the development of a software-specifications manual that was carefully reviewed to match the mathematical formulations in Volume 1 of the final report. Furthermore, Volume 1 of the final report contains all the mathematical formulations necessary for the user to perform independent hand calculations. Upon completion of the user-friendly computer software supported by Volume 1, a modeling comparison will be conducted with relevant scenarios using other computerized software, including the RESRAD code developed for DOE and IMPACTS-BRC developed for NRC.

Comment 2: A comment from DOE recommended a cooperative interagency research effort to support the criteria. The effort could be in the development and verification of the computer codes and their mathematical models. To verify the models, DOE recommends that several NRC staff select a scenario for soil-contamination criteria and attempt an analysis with both RESRAD and the NRC methods to determine which is more desirable.

Response: There have been interagency discussions regarding potential joint research projects that could be conducted to evaluate the models and methods for translating residual contamination levels to annual dose. Staff from the NRC have agreed to participate in a joint project with DOE to collect experimental data from a contaminated facility and to relate surface-contamination levels to external dose rates. These data should be useful in future model-verification studies. Additional model intercomparisons will be conducted to evaluate the operation of the models supporting this document. No changes were made to the final report because of this comment.

Comment 3: One commenter found the comparisons with Regulatory Guides 1.109 and 1.86 (NRC 1977 and 1974) to be useful and commented that the "now versus then" agreement was very good. A second commenter indicated that there was no basis for these comparisons because Regulatory Guide 1.86 was based on measurement, not potential dose considerations; this commenter went on to suggest further comparisons that might be more meaningful.

Response: Although the existing Regulatory Guides and the methods used for this report have a different basis, a comparison is useful to help indicate the impact of the revisions. As stated in response to Comment 1 above, PNL will conduct an extended modeling comparison with relevant scenarios using other methods and include these comparisons in a separate volume supporting this document.

Comment 4: One commenter reported initial results obtained using the RESRAD computer program. The commenter indicated that the models and pathways of exposure generally compare with those considered by RESRAD; however, some differences do occur. The commenter indicated that RESRAD contains more conservatism and a different ground-water model, but that ground water is so site-specific that both approaches should be used with caution. A second commenter indicated that the RESRAD code is more user-friendly than the methods contained in draft NUREG/CR-5512.

Response: As previously noted, an expanded modeling analysis is planned and formal documentation of the methods and models used to generate this report will be provided in Volume 3. Perhaps it is not surprising that the RESRAD code produced initial results that are more conservative than the models used in this analysis because this analysis was intended to produce prudently conservative (not worst-case) results. However, a full comparison needs to be completed before any conclusions can be made. Finally, the computerized method and models used in the draft report were simply listed in an appendix; they were not made publicly available for testing during the review. Thus, complete comparisons using anything except hand calculations were not possible. Attempts will be made to ensure that the

final software is user-friendly and documented in an understandable manner; however, no changes were made to the final report because of this comment.

Comment 5: A set of five detailed comments was submitted concerning an initial comparison with RESRAD completed by DOE. The first two comments outlined the comparison using 100 pCi/g of plutonium isotopes. The results with zero decay were quite close; RESRAD produced 3.7 mrem/y versus 2.6 mrem/y using the results for this study. The commenters also discussed the problem of radioactive decay and the ingrowth of ^{241}Am at different times. When an attempt was made to conduct a comparison with 15 years of decay, one commenter noted, RESRAD continued to produce 3.7 mrem/y, while the results of this study, including daughter ingrowth, produced 54 mrem/y. Another commenter indicated that there was some confusion about how to perform the calculations using the dose conversion factors in the draft report. This commenter also indicated that not including soil-removal mechanisms would lead to greatly different results.

Response: Major revisions to the modeling approach have been made. Instead of listing the scenario dose conversion factors as the total activity of parent plus daughters, as was done in the draft, the final report lists the factors by activity of the parent alone. This change should clarify the factors and make them simpler to use. Comparisons at different decay periods are possible by simply using the mixtures representing different equilibrium conditions present at different times. As previously stated, a sensitivity study and model comparison is documented in Volume 3 of this report.

A.6 Other Issues

The final category of comments included six comments that did not fit into the other categories. One commenter indicated that the document should include an analysis of contaminated piping or other equipment that may be left in place for reuse. A second commenter indicated that the analysis in the draft would be of little use because it did not include key radionuclides in the uranium and thorium decay chains (i.e., $^{220/222}\text{Rn}$, $^{212/214}\text{Po}$, ^{214}Pb , ^{214}Bi , and ^{208}Tl). A set of comments questioned the scenario results and indicated that their application to the FUSRAP and the Uranium Mill Tailings Remedial Action Project (UMTRAP) sites might be limited. The following general comments and responses summarize the significant issues raised and the modifications that have been made to the final report.

Comment 1: Piping and other components are not considered in draft NUREG/CR-5512. If this document and the revised NRC policy are to replace Regulatory Guide 1.86 as a basis for determining criteria for unrestricted release, piping and components should be included. It is not adequate to assume that all slightly contaminated components would be removed. For example, slightly contaminated systems might remain in the facility if it were converted into a fossil-fueled power plant.

Response: Any unusual contamination left in place requires NRC approval. Such approval could be given to justify a specific request after the NRC evaluates the pathway analysis submitted by the licensee. Recycle or reuse of contaminated equipment, including piping or other components that may be left in place, will be the subject of a separate, future NRC technical report. However, volume contamination was included in the building renovation scenario and an accounting of the total inventory left onsite was included in the water-use scenario. No changes were made to the final report because of this comment.

- Comment 2:** Many residual radioactivity sites contain materials contaminated with uranium, thorium, and radium. This document will have limited utility for these sites because essential radionuclides (such as $^{220/222}\text{Rn}$, $^{212/214}\text{Po}$, ^{214}Pb , and ^{208}Tl) are omitted.
- Response:** With the exception of radon gas, the radionuclides mentioned in the comment have very short half-lives (from a fraction of a second to about 30 minutes). They were all included as implicit daughters in equilibrium with longer-lived parents in the draft report. For the final report, the format of the information has been changed and the explanation of the role of decay progeny has been expanded to make the information more useful. The major exception is the omission of a special model for radon in buildings. This omission is justified, however, because of the potential complexity in modeling the indoor radon aerosol and the intent to produce generic models and scenarios. Indoor radon aerosol modeling would also be of limited usefulness when compliance with EPA standards can be made using measurements. No further changes were made to the final report because of this comment.
- Comment 3:** Two commenters requested a verification that the surface-contamination (building occupancy) scenario is more restrictive than the volume-contamination (building renovation) scenario, and requested a basis for the conclusion.
- Response:** An expanded discussion of the two scenarios has been provided; however, the two scenarios consider different situations. It is not correct to assume that the surface scenario provides the more restrictive limits (i.e., for beta and alpha sources, volume contamination may be more important than surface contamination). No further change was made to the final document because of this comment.
- Comment 4:** The comparison-to-standards section should be expanded to include a comparison with the proposed EPA guidance on transuranic elements in soil.
- Response:** A comparison with the proposed EPA guidance was intentionally omitted because the standards are not in final form. No change has been made to the final report because of this comment.
- Comment 5:** The scenario analysis is limited to NRC-licensed facilities. With modifications, the information should be applicable to most types of facilities. For FUSRAP, UMTRAP, and DOE surplus facilities, measurements of the radiological conditions would be necessary to apply the methodology.
- Response:** The generic analysis should permit consideration of any type of facility, as long as detailed information concerning the radionuclide inventory is developed. This information should be available from a detailed radiological survey conducted for a site prior to release. No change is made to the final document based on this comment.

A.7 References

- 10 CFR 61. 1990. U.S. Nuclear Regulatory Commission, "Licensing Requirements for Land Disposal of Radioactive Waste." *U.S. Code of Federal Regulations*.
- Anspaugh, L. R., J. H. Shinn, P. L. Phelps, and N. C. Kennedy. 1974. "Resuspension and Redistribution of Plutonium in Soils." *Health Physics* 4(29):571-582.

Appendix A

- Berger, J. D. 1992. *Manual for Conducting Radiological Surveys in Support of License Termination*. NUREG/CR-5849 (ORAU-92/C57), U.S. Nuclear Regulatory Commission, Washington, D.C.
- Eckerman, K. F., A. B. Wolbarst, and A. C. B. Richardson. 1988. *Limiting Values of Radionuclide Intake and Air Concentration and Dose Conversion Factors for Inhalation, Submersion, and Ingestion*. Federal Guidance Report No. 11, EPA-520/1-88-020, U.S. Environmental Protection Agency, Washington, D.C.
- Eckerman, K. F., and J. C. Ryman. 1992. *Dose Coefficients for External Exposure to Radionuclides Distributed in Air, Water, or Soil*. Federal Guidance Report No. 12, U.S. Environmental Protection Agency, Washington, D.C.
- International Commission on Radiological Protection (ICRP). 1979-1988. *Limits for Intakes of Radionuclides by Workers*. ICRP Publication 30, Parts 1-4 (and supplements), Vol. 2 (No. 3/4), Vol. 4 (No. 3/4), Vol. 6 (No. 2/3), and Vol. 19 (No. 4), Pergamon Press, New York.
- Kennedy, W. E., Jr., and R. A. Peloquin. 1990. *Residual Radioactive Contamination from Decommissioning: Technical Basis for Translating Contamination Levels to Annual Dose, Draft Report for Comment*. Draft NUREG/CR-5512, PNL-7212, NRC, Washington, D.C.
- National Research Council. 1990. *Health Effects of Exposure to Low Levels of Ionizing Radiation*. BEIR V, National Academy Press, Washington, D.C.
- Oztunali, O. I., G. C. Re, P. M. Moskowitz, E. D. Picazo, and C. J. Pitt. 1981. *Data Base for Radioactive Waste Management: Impacts Analyses Methodology Report*. NUREG/CR-1759, Vol. 3, NRC, Washington, D.C.
- U.S. Department of Energy (DOE). 1988. *External Dose Rate Conversion Factors for Calculation of Dose to the Public*. DOE/EH-0070, DOE, Washington, D.C.
- U.S. Nuclear Regulatory Commission (NRC). 1974. *Termination of Operating Licenses for Nuclear Reactors*. Regulatory Guide 1.86, NRC, Washington, D.C.
- U.S. Nuclear Regulatory Commission (NRC). 1977. *Calculation of Annual Doses to Man from Routine Releases of Reactor Effluents for the Purpose of Evaluating Compliance with 10 CFR Part 50, Appendix I*. Regulatory Guide 1.109, NRC, Washington, D.C.

Appendix B

Extended Nomenclature and Methodology

Appendix B

Extended Nomenclature and Methodology

This appendix is an extension to the nomenclature and methodology described in Section 2 of this report. The details presented in this appendix explain the nomenclature and methodology needed for a complete evaluation of the annual total effective dose equivalent (TEDE) from residual radioactive contamination. Section B.1 provides the basic radioactive decay equations for cases with and without removal by loss processes (e.g., weathering from plant surfaces). Section B.2 illustrates use of the decay equations (operators $A\{\}$, and $A_e\{\}$) for evaluating the change in activity or concentration over a time period. Derivations of basic equations are shown for decay with removal. Equivalence between the decay operator notation and the original Bateman equations is demonstrated. The evaluation of time integrals (operators $S\{\}$ and $S_e\{\}$) is demonstrated in Section B.3 based on the basic form of equations for decay over a time period. Section B.4 presents a derivation of equations for deposition accumulation (operators $R\{\}$ and $R_e\{\}$) for evaluation of an activity or concentration at the end of the accumulation period. The deposition accumulation equations are extended to give the time integral of activity or concentration over a deposition period (operators $G\{\}$ and $G_e\{\}$) in Section B.5. The solution to the water-use model for the drinking water scenario (operators $A_{dk}\{\}$ and $S_{dk}\{\}$) is demonstrated in Section B.6 based on the basic decay equations given in Section B.1 for decay with removal, and Section B.3 for the time integral of decay with removal. Finally, the solution to the water-use model for the residential scenario is described in Section B.7 (operators $A_{rk}\{\}$ and $S_{rk}\{\}$).

B.1 Radionuclide Decay Calculations

The mathematical description of radioactive decay processes was first described by Bateman (1910) in the form of equations giving the amount (in atoms) of each decay chain member present as a function of time. These equations are defined for a chain of radionuclides without branching and with 100% transition from each chain member to the next chain member. The initial amount of chain member present at time zero is represented in the equations.

Skrable et al. (1974) extended the Bateman equations to consider cases involving a constant independent rate of production of each chain member and removal mechanisms other than radioactive transitions. They also indicated how to use their equations to represent radioactive decay sequences involving branching. When branching occurs, the amount of each chain member present at a given time is evaluated as the sum of contributions from each branch of the decay sequence, a method suggested by Friedlander and Kennedy (1955). The equations as presented are similar to the original Bateman equations, with expansion of the exponential terms to include the independent rate of production of each chain member. The expansions represent the time integral of production at a constant rate.

Scherpelz and Desrosiers (1980) have described a recurrence formula based on the work of Hamawi (1971) that can be used to evaluate radioactive chain decay. Their method provides the Bateman equations when expanded and condensed. They also indicate that the time integral of the amount of each chain member can be evaluated by replacing the exponential term by the integral form of the exponential term. The replacement is applied in the equations presented for radioactive decay calculations described in this report.

Appendix B

The forms of radioactive decay equations described by Skrable et al. (1974) and Scherpelz and Desrosiers (1980) are defined for radioactive decay in sequences without branching. Branching can be accounted for by multiple applications of the equations and summing appropriately. Also, both equation sets can be used to account for loss or removal of each chain member by processes other than radioactive decay.

An alternate form of the radioactive decay equations has been developed and implemented in computer programs at Pacific Northwest Laboratory (Streng, Hendrickson, and Watson 1971; Streng and Watson 1973; Streng, Watson, and Houston 1975; Houston, Streng, and Watson, 1976; Napier, Peloquin, and Streng 1986; Napier et al. 1988; Streng et al. 1990). The equations for this alternate form differ from those presented by the other authors discussed above in that the solution for radioactive decay chains with branching is included explicitly in the representations: no addition of contributions from multiple applications for branches is necessary. This alternate form is used as the basis for radioactive decay calculations defined in this report, including evaluations for the three-box water-use model.

B.1.1 General Decay Equations

The radioactive decay process occurs in a random manner that may be described mathematically. When a parent radionuclide i undergoes a transition to a progeny radionuclide (or stable isotope), the quantity of the parent remaining in a medium m after a time period t is written as:

$$C_{mi}(t) = C_{mi}(0) e^{-\lambda_{ri}t} \quad (\text{B.1})$$

where $C_{mi}(t)$ = the activity of a radionuclide i at time t in a medium m (pCi)

$C_{mi}(0)$ = the activity of a radionuclide at time zero in a medium m (pCi)

λ_{ri} = radiological decay constant for radionuclide i (d^{-1}).

By defining the source of production (i.e., the parent radionuclides) for each chain member, the decay equations can be used to evaluate chains with multiple branching in a single pass through the system of equations. The general form of the decay equation for the j th member of a decay chain, using the notation defined for this study, is as follows:

$$C_{mj}(t) = \lambda_{rj} \sum_{n=1}^j K_{jn} e^{-\lambda_{rn}t} \quad (\text{B.2})$$

where $C_{mj}(t)$ = quantity of chain member j at time t in medium m (pCi)

λ_{rj} = decay constant of radionuclide j (d^{-1})

λ_{rn} = decay constant of radionuclide n (d^{-1})

K_{jn} = coefficient for term n for chain member j (pCi·d).

As Equation (B.2) indicates, the solution for the j th member is the sum of j terms, with an exponential component for each member of the decay chain. The coefficients (K_{jn}) are determined by the decay chain data (half-lives and branching fraction) and by the initial amount of the precursor radionuclides present at the start of the time period. The amount of each radionuclide is expressed in activity units (e.g., pCi).

Evaluation of the coefficients is performed starting with the first member and proceeding sequentially through the chain. The number of coefficients needed for a given chain member is equal to the position of the member in the chain. For example, the third chain member requires three coefficients. The coefficient for the first chain member is equal to the activity present at the start of the decay period divided by the radionuclide decay rate constant:

$$K_{11} = \frac{C_{m1}(0)}{\lambda_{r1}} \quad (\text{B.3})$$

The coefficients for other chain members are evaluated using the following equations:

$$K_{jn} (n=1 \text{ to } j-1) = \frac{\sum_{p=n}^{j-1} d_{pj} \lambda_{rp} K_{pn}}{\lambda_{rj} - \lambda_{rn}} \quad (\text{B.4})$$

and

$$K_{jj} = \frac{C_{mj}(0)}{\lambda_{rj}} - \sum_{n=1}^{j-1} K_{jn} \quad (\text{B.5})$$

where d_{pj} is the fraction of radionuclide p transitions that result in production of radionuclide j (dimensionless) and other terms are as previously defined. This generic representation of the radioactive decay process allows transition and branching from any chain member to any member lower in the chain. In practice, it is only necessary to include terms in the equation for which the branching fractions (d_{pj}) are non-zero.

An alternate form of Equation (B.2), for the amount of each chain member present after a time period t , can be derived by combining Equations (B.2) through (B.5) and separating the term for the last chain member (j). The result is as follows:

$$C_{mj}(t) = C_{mj}(0) e^{-\lambda_{rj}t} + \lambda_{rj} \sum_{n=1}^{j-1} K_{jn} (e^{-\lambda_{rn}t} - e^{-\lambda_{rj}t}) \quad (\text{B.6})$$

This form of the radioactive decay equation is similar to (but still different from) the representations used by Skrable et al. (1974) and Scherpelz and Desroisers (1980) in that the formulation involves the difference of exponentials. Either of the above representations can be evaluated for a radioactive decay chain that has no branching to obtain the original Bateman (1910) equations. In so doing, all decay fractions (d_{pj}) in which the indices differ by more than one (e.g., d_{13}) are set to zero. For chain members beyond the first two, the evaluation involves some algebraic manipulations to collapse terms to the form in Bateman's representation. This process is demonstrated in Section B.2.

The operator notation used to designate decay for a time period is as follows:

Appendix B

$$A\{C_*,t_*\} \tag{B.7}$$

where $A\{\}$ = the operation of decay of activity in a medium for a time period (units same as C_* units)

C_* = the array of initial concentrations in a medium (activity or concentration units, e.g. pCi, pCi/g, pCi/kg)

t_* = time period for evaluation of concentration (d).

The above equations define the method used to evaluate the amount of a chain member present after a specified time period, t . Another important calculation needed for the dose calculations of this report is the time integral over a specified time period. Inspection of Equations (B.2) through (B.5) reveals that the time parameter, t , appears only in the exponential term of Equation (B.2). This allows the time integral to be evaluated as the integral of the sum of exponential terms. By replacing each exponential expression in Equation (B.2) with the time integral of the exponential evaluated between time zero and time t , the time integral of activity of each chain member can be determined. Details of this procedure are given in Section B.3. This substitution is represented as follows:

$$e^{-\lambda_m t} \text{ is replaced by } \left(1 - e^{-\lambda_m t}\right) / \lambda_m \tag{B.8}$$

The substitution indicated by Equation B.8 allows evaluation of the time integral of the amount of a radionuclide present over a time period. The time units of the time integral correspond to those used for t . The units of t must also be the inverse of the units for λ_m .

The operator notation used to designate the time integral for a time period is as follows:

$$S\{C_*,t_*\} \tag{B.9}$$

where $S\{\}$ = the operation of time integration of activity in a medium for a time period (units of C_* multiplied by units of t_*), and other terms are as previously defined.

Another application of the decay equations is to evaluate the concentration in a medium after deposition and accumulation at a constant rate for a period of time. This application is needed in evaluation of the activity in soil from irrigation water deposition. The derivation of equations for deposition accumulation are presented in Section B.4. The resulting forms of the equations are very similar to Equations (B.2) through (B.4). The equations may be represented by replacing the initial radionuclide activities, $C_{mj}(0)$, in Equations (B.2), (B.3), and (B.5) with the corresponding constant deposition rates, R_{mj} . Also, the exponential term is replaced as follows:

$$e^{-\lambda_m t} \text{ is replaced by } \frac{1 - e^{-\lambda_m t}}{\lambda_m} \tag{B.10}$$

The derivation of equations for deposition at a constant rate is presented in Section B.4. The deposition, accumulation operator notation representing these calculations is as follows:

$$R\{R^*,t^*\} \quad (B.11)$$

where $R\{\}$ = the operation of deposition accumulation for deposition at a constant rate (units of R_* multiplied by units of t_* , e.g., pCi/g dry-weight soil)

R_* = the array of constant deposition rates for each chain member (units of activity per day per unit mass of receiving medium, e.g., pCi/d•g dry-weight soil)

t_* = time period for evaluation of concentration (d).

The fourth application of the decay equations is for evaluation of a deposition, accumulation, and time integration of a constant input rate by irrigation. Equations for this application can be evaluated as the time integral of the for the deposition accumulation at a constant rate, with integration over the period from 0 to t . The integration step involves integration of the term on the right side of Equation (B.10), as described in Section B.5. The final form for Equation (B.2) is then written by replacing the exponential terms as follows:

$$e^{-\lambda_{rn}t} \text{ is replaced by } \left[t - \left(1 - e^{-\lambda_{rn}t} \right) / \lambda_{rn} \right] / \lambda_{rn} \quad (B.12)$$

The deposition, accumulation, and time-integral evaluation also involves replacement of the initial radionuclide quantities, $C_{mj}(0)$, with the constant deposition rates, R_{mj} , as demonstrated in Section B.4.

The operator notation representing deposition, accumulation, and time integration is as follows:

$$G\{R^*,t^*\} \quad (B.13)$$

where $G\{\}$ = the operation of deposition, accumulation, and time integration for a time period (units of R_* times squared units of t_*)

R_* = the array of constant deposition rates for each chain member (units of activity per day per unit mass of receiving medium, e.g., pCi/d•g dry-weight soil)

t_* = time period for evaluation (d).

B.1.2 Equations for Decay with Removal

In the soil scenarios, the agricultural pathway models require consideration of radioactive decay in a system where other removal mechanisms may also be occurring. For example, the activity on plant surfaces is subject to loss by weathering processes. To evaluate the activity in plants at the end of a growing season, this weathering loss must be considered when performing the decay calculations.

The equations for decay with removal are similar to the equations for decay without removal, i.e., Equations (B.2), (B.3), (B.4), and (B.5). The difference is in use of an effective rate constant in place of the decay constant in specific parts of the equations. The effective rate constant is the sum of the decay constant and the removal rate constant:

Appendix B

$$\lambda_{ej} = \lambda_{rj} + \lambda_w \quad (\text{B.14})$$

where λ_{ej} is the effective rate constant (d^{-1}), and λ_w is the removal rate constant (d^{-1}), shown here as the weathering rate constant.

The equations for decay and loss are given as follows, based on Equations (B.2), (B.3), (B.4), and (B.5):

$$C_{mj}(t) = \lambda_{rj} \sum_{n=1}^j K_{jn} e^{-\lambda_{en}t} \quad (\text{B.15})$$

$$K_{11} = \frac{C_{m1}(0)}{\lambda_{r1}} \quad (\text{B.16})$$

$$K_{jn} \text{ (n=1 to j-1)} = \frac{\sum_{p=n}^{j-1} d_{pj} \lambda_{rp} K_{pn}}{\lambda_{ej} - \lambda_{en}} \quad (\text{B.17})$$

$$K_{jj} = \frac{C_{mj}(0)}{\lambda_{rj}} - \sum_{n=1}^{j-1} K_{jn} \quad (\text{B.18})$$

The derivation of these equations is demonstrated in Section B.2 for the first two decay chain members. Equations (B.15) through (B.18) can be combined to obtain an alternate expression comparable to Equation (B.6), as follows:

$$C_{mj}(t) = C_{mj}(0) e^{-\lambda_{ej}t} + \lambda_{rj} \sum_{n=1}^{j-1} K_{jn} (e^{-\lambda_{en}t} - e^{-\lambda_{ej}t}) \quad (\text{B.19})$$

Equations (B.14) through (B.18) also represent the evaluations for the deposition, accumulation operator and for the deposition, accumulation and time-integration operator, when appropriate substitution is made for the exponential terms. The substitutions parallel those indicated by Equations (B.8), (B.10), and (B.12).

For the time-integral equations (see Section B.3.1), the exponential term of Equation (B.15) is replaced with its integral form as follows:

$$e^{-\lambda_{en}t} \text{ is replaced by } \left[1 - e^{-\lambda_{en}t} \right] / \lambda_{en} \quad (\text{B.20})$$

This substitution is also used for the deposition accumulation calculation with removal as described in Section B.4.1. For the deposition, accumulation and time-integration (see Section B.5.1), the exponential term of Equation (B.15) is replaced as follows:

$$e^{-\lambda_{en}t} \text{ is replaced by } \left[t - \left(1 - e^{-\lambda_{en}t} \right) / \lambda_{en} \right] / \lambda_{en} \quad (\text{B.21})$$

The decay with removal calculation is represented by the decay operator as follows:

$$A_e\{C_*, t_*\} \quad (\text{B.22})$$

where $A_e\{\}$ represents the operation of radioactive decay with removal using an effective removal rate constant, λ_{en} , and other terms are as previously defined. The time integral with removal is represented similarly:

$$S_e\{C_*, t_*\} \quad (\text{B.23})$$

where $S_e\{\}$ represents the operation of the time integration with removal using an effective removal rate constant. The deposition accumulation with removal calculation is indicated by the following operator notation:

$$R_e\{R_*, t_*\} \quad (\text{B.24})$$

where $R_e\{\}$ represents the operation of deposition, accumulation, with removal and other terms are as previously defined.

The time-integration with removal is represented as follows:

$$G_e\{R_*, t_*\} \quad (\text{B.25})$$

where $G_e\{\}$ represents the operation of deposition, accumulation, and time-integration with removal, using an effective removal rate constant.

B.1.3 Decay Equation Units

The equations provided in this section for evaluation of the amount of each chain member present after a time period have been defined for radionuclide amounts defined in units of activity (e.g., pCi) present at the start of the time period. However, in comparing equations in this report with those of the original Bateman (1910) publication, a conversion between activity and atoms must be made. The basic relationship between the two units is as follows:

$$\text{Activity (transitions/time)} = \text{Rate Constant (1/time)} \times \text{Atoms.} \quad (\text{B.26})$$

The conversion from activity units to units proportional to atoms is performed as the inverse of the above equation, as follows:

$$Q_{mj}(t) = k C_{mj}(t) / \lambda_{rj} \quad (\text{B.27})$$

Appendix B

where $Q_{mj}(t)$ = atoms of radionuclide j present in medium m at the start of the period (atoms)

$C_{mj}(t)$ = activity of radionuclide j present in medium m at time t (activity units)

k = constant of proportionality to relate activity units to atom units.

The numerical value for k depends on the choice of activity and time units employed. For activity in Bq and time in seconds, the value for k is 1.0, because 1 Bq is defined as 1 transition per second. However, the value for k is irrelevant to implementation of the equations because k appears in each term of the equation being converted and can be cancelled.

B.2 Radioactive Decay Operators

This section demonstrates correctness and use of the decay equations for decay over a time period, with and without removal processes (operators $A\{\}$ and $A_e\{\}$). The derivation of the equations for decay with removal (Equations [B.14] through [B.18]) are presented in Section B.2.1 as the solution of the basic differential equation for decay. In Section B.2.2 the basic equations for decay without removal are expanded to demonstrate their equivalence with the original Bateman (1910) equations.

B.2.1 Decay Operator with Removal $A_e\{\}$

The change in activity or concentration of a radionuclide in a medium with removal can be written as follows:

$$\frac{dC_{mj}}{dt} = \sum_{n=1}^{j-1} d_{nj} \lambda_{rj} C_{mn} - (\lambda_w + \lambda_{rj}) C_{mj} \quad (\text{B.28})$$

where C_{mj} = concentration of radionuclide chain member j in medium m (pCi)

C_{mn} = concentration of precursor radionuclide chain member n in medium m (pCi)

λ_{rj} = radioactive decay rate constant for radionuclide j (d^{-1})

λ_w = rate constant for loss of activity from a medium (d^{-1})

d_{nj} = fraction of precursor radionuclide n transitions that result in production of radionuclide chain member j (dimensionless).

The solution to Equation (B.28) will be derived for the parent and first progeny radionuclides. Equation (B.28) can be written in terms of these chain members as follows, for the parent ($j=1$):

$$\frac{dC_{m1}}{dt} = -\lambda_{e1} C_{m1} \quad (\text{B.29})$$

and for the first progeny ($j=2$),

$$\frac{dC_{m2}}{dt} = d_{12}\lambda_{r2}C_{m1} - \lambda_{e2}C_{m2} \quad (B.30)$$

where C_{m1} = concentration of parent radionuclide chain member (j=1) in medium m (pCi)

C_{m2} = concentration of first progeny radionuclide (j=2) in medium m (pCi)

d_{12} = fraction of precursor radionuclide 1 (parent) transitions that result in production of radionuclide chain member 2 (dimensionless)

λ_{e1} = rate constant for removal and decay of radionuclide 1, evaluated as the sum of λ_w and λ_{r1} (d^{-1}).

λ_{e2} = rate constant for removal and decay of radionuclide 2, evaluated as the sum of λ_w and λ_{r2} (d^{-1}).

The solution to Equation (B.29) is evaluated by first transferring terms containing the concentration of the parent radionuclide in the medium (C_{m1}) to the left side of the equation, and then multiplying by the integration factor, $e^{\lambda_{e1}t}$:

$$[dC_{m1} + \lambda_{e1}C_{m1}dt] e^{\lambda_{e1}t} = 0 \quad (B.31)$$

The left side of the equation can be written as a differential and then integrated to give the following expression:

$$C_{m1} e^{\lambda_{e1}t} = \text{Constant} \quad (B.32)$$

Evaluation of the constant of integration is performed using the condition that at $t = 0$, $C_{m1} = C_{m1}(0)$. The constant is given by:

$$\text{Constant} = C_{m1}(0) \quad (B.33)$$

and the final expression for the amount of parent radionuclide in a medium is given by:

$$C_{m1} = C_{m1}(0) e^{-\lambda_{e1}t} \quad (B.34)$$

This expression can be seen to be equivalent to the decay operator notation for the change of activity over a time period, t , as given by Equations (B.15) and (B.16).

The solution of Equation (B.30) for the first progeny radionuclide can be found by first moving terms containing the medium concentration parameter, C_{m2} , to the left side of the equation and multiplying by the integration factor. The expression of Equation (B.34) is also substituted into Equation (B.30) for the parent concentration in the medium. The result of these actions is the following expression:

$$[dC_{m2} + \lambda_{e2}C_{m2}dt] e^{\lambda_{e2}t} = d_{12}\lambda_{r2}C_{m1}(0) e^{(\lambda_{e2}-\lambda_{e1})t} dt \quad (B.35)$$

Appendix B

The left side of this equation can be written as a differential, and the whole equation can be integrated to give the following expression:

$$C_{m2} e^{\lambda_{e2}t} = \frac{d_{12}\lambda_{r2}C_{m1}(0)}{(\lambda_{e2} - \lambda_{e1})} e^{(\lambda_{e2}-\lambda_{e1})t} + \text{Constant} \quad (\text{B.36})$$

Multiplying through by the inverse of the integrating factor gives the following expression:

$$C_{m2} = \frac{d_{12}\lambda_{r2}C_{m1}(0)}{(\lambda_{e2} - \lambda_{e1})} e^{-\lambda_{e1}t} + [\text{Constant}] e^{-\lambda_{e2}t} \quad (\text{B.37})$$

The constant can be evaluated from the condition that $C_{m2} = C_{m2}(0)$ at $t = 0$. Substituting this condition into Equation (B.37) gives the following expression for the constant:

$$\text{Constant} = + C_{m2}(0) - \frac{d_{12}\lambda_{r2}C_{m1}(0)}{(\lambda_{e2} - \lambda_{e1})} \quad (\text{B.38})$$

Substituting this expression for the constant and combining terms results in the following expression for the amount of first progeny radionuclide in the medium as a function of time:

$$C_{m2} = \frac{d_{12}\lambda_{r2}C_{m1}(0)}{(\lambda_{e2} - \lambda_{e1})} e^{-\lambda_{e1}t} + \left[C_{m2}(0) - \frac{d_{12}\lambda_{r2}C_{m1}(0)}{(\lambda_{e2} - \lambda_{e1})} \right] e^{-\lambda_{e2}t} \quad (\text{B.39})$$

This equation is equivalent to the equations generated using the formulas for the decay operator with removal (Equations [B.14] through [B.18]). This derivation demonstrates that the solution to the decay with removal case can be written using Equations (B.14) through (B.18). Examples of equation generation using decay operator equations are given in the next section.

B.2.2 Decay Operator A{}

This section provides a demonstration that the basic decay equations (Equations [B.2] through [B.5]) are equivalent to the original Bateman (1910) equations for a decay sequence that has no branching.

Consider a four-member decay chain with initial activities (pCi) of the four members given by $C_{m1}(0)$, $C_{m2}(0)$, $C_{m3}(0)$, and $C_{m4}(0)$. The equations for each chain member can be written by inspection from Equations (B.2), (B.3), (B.4), and (B.5). For the first chain member ($j=1$), the equation for the activity present as a function of time is

$$C_{m1}(t) = \lambda_{r1}K_{11} e^{-\lambda_{r1}t} \quad (\text{B.40})$$

or,

$$C_{m1}(t) = \frac{\lambda_{r1} C_{m1}(0) e^{-\lambda_{r1}t}}{\lambda_{r1}} = C_{m1}(0) e^{-\lambda_{r1}t} \quad (\text{B.41})$$

For the second chain member (j=2), the equation is

$$C_{m2}(t) = \lambda_{r2} [K_{21} e^{-\lambda_{r1}t} + K_{22} e^{-\lambda_{r2}t}] \quad (\text{B.42})$$

where K_{21} is $\frac{d_{12} \lambda_{r1} K_{11}}{\lambda_{r2} - \lambda_{r1}}$ and K_{22} is $\frac{C_{m2}(0)}{\lambda_{r2}} - K_{21}$. The final expression for $C_{m2}(t)$ is:

$$\begin{aligned} C_{m2}(t) &= \lambda_{r2} \left\{ \frac{C_{m1}(0) d_{12} \lambda_{r1}}{(\lambda_{r2} - \lambda_{r1}) \lambda_{r1}} e^{-\lambda_{r1}t} + \left[\frac{C_{m2}(0)}{\lambda_{r2}} - \frac{d_{12} \lambda_{r1} C_{m1}(0)}{(\lambda_{r2} - \lambda_{r1}) \lambda_{r1}} \right] e^{-\lambda_{r2}t} \right\} \\ &= \frac{d_{12} \lambda_{r2} C_{m1}(0)}{\lambda_{r2} - \lambda_{r1}} e^{-\lambda_{r1}t} + \left[C_{m2}(0) - \frac{d_{12} \lambda_{r2} C_{m1}(0)}{\lambda_{r2} - \lambda_{r1}} \right] e^{-\lambda_{r2}t} \end{aligned} \quad (\text{B.43})$$

For the third chain member (j=3), the equation is

$$C_{m3}(t) = \lambda_{r3} [K_{31} e^{-\lambda_{r1}t} + K_{32} e^{-\lambda_{r2}t} + K_{33} e^{-\lambda_{r3}t}] \quad (\text{B.44})$$

The first coefficient, K_{31} , is evaluated using Equation (B.4) as follows:

$$K_{31} = \frac{\sum_{p=1}^2 d_{p3} \lambda_{rp} K_{p1}}{(\lambda_{r3} - \lambda_{r1})} = \frac{d_{13} \lambda_{r1} K_{11} + d_{23} \lambda_{r2} K_{21}}{(\lambda_{r3} - \lambda_{r1})} \quad (\text{B.45})$$

Using the previously defined expressions for K_{11} and K_{21} results in the final expression for K_{31} :

$$K_{31} = \frac{d_{13} C_{m1}(0)}{(\lambda_{r3} - \lambda_{r1})} + \frac{d_{23} \lambda_{r2} d_{12} C_{m1}(0)}{(\lambda_{r3} - \lambda_{r1})(\lambda_{r2} - \lambda_{r1})} \quad (\text{B.46})$$

The second coefficient, K_{32} , is also evaluated using Equation (B.4) as follows:

Appendix B

$$K_{32} = \frac{\sum_{p=2}^2 d_{p3} \lambda_{rp} K_{p2}}{\lambda_{r3} - \lambda_{r2}} = \frac{d_{23} \lambda_{r2} K_{22}}{\lambda_{r3} - \lambda_{r2}} \quad (\text{B.47})$$

Using the previously defined expressions for K_{22} and K_{21} , the final expression for K_{32} becomes

$$K_{32} = \frac{d_{23} C_{m2}(0)}{(\lambda_{r3} - \lambda_{r2})} - \frac{d_{23} \lambda_{r2} d_{12} C_{m1}(0)}{(\lambda_{r3} - \lambda_{r2})(\lambda_{r2} - \lambda_{r1})} \quad (\text{B.48})$$

The third coefficient for the third chain member, K_{33} , is evaluated according to Equation (B.5) as follows:

$$K_{33} = \frac{C_{m3}(0)}{\lambda_{r3}} - \sum_{n=1}^2 K_{3n} = \frac{C_{m3}(0)}{\lambda_{r3}} - K_{31} - K_{32} \quad (\text{B.49})$$

Substituting the expressions for K_{31} and K_{32} into this expression gives the following equation for coefficient K_{33} :

$$K_{33} = \frac{C_{m3}(0)}{\lambda_{r3}} - \frac{d_{13} C_{m1}(0)}{\lambda_{r3} - \lambda_{r1}} - \frac{d_{23} \lambda_{r2} d_{12} C_{m1}(0)}{(\lambda_{r3} - \lambda_{r1})(\lambda_{r2} - \lambda_{r1})} - \frac{d_{23} C_{m2}(0)}{(\lambda_{r3} - \lambda_{r2})} + \frac{d_{23} \lambda_{r2} d_{12} C_{m1}(0)}{(\lambda_{r3} - \lambda_{r2})(\lambda_{r2} - \lambda_{r1})} \quad (\text{B.50})$$

An important algebraic manipulation will now be demonstrated to simplify the above equation for K_{33} . Note that the numerators of the 3rd and 5th term on the right side of Equation (B.50) are the same: $[d_{23} \lambda_{r2} d_{12} C_{m1}(0)]$. The following identity is applied to these two terms:

$$\frac{1}{(c-b)(b-a)} - \frac{1}{(c-a)(b-a)} = \frac{1}{(c-a)(c-b)} \quad (\text{B.51})$$

with $a \neq b$, $b \neq c$, and $a \neq c$. Applying this reduction to the 3rd and 5th terms gives the following expression (numerators omitted for simplicity):

$$\frac{1}{(\lambda_{r3} - \lambda_{r2})(\lambda_{r2} - \lambda_{r1})} - \frac{1}{(\lambda_{r3} - \lambda_{r1})(\lambda_{r2} - \lambda_{r1})} = \frac{1}{(\lambda_{r3} - \lambda_{r1})(\lambda_{r3} - \lambda_{r2})} \quad (\text{B.52})$$

The expression for coefficient K_{33} can now be written in the simpler form:

$$K_{33} = \frac{C_{m3}(0)}{\lambda_{r3}} - \frac{d_{13} C_{m1}(0)}{\lambda_{r3} - \lambda_{r1}} - \frac{d_{23} C_{m2}(0)}{(\lambda_{r3} - \lambda_{r2})} + \frac{d_{23} \lambda_{r2} d_{12} C_{m1}(0)}{(\lambda_{r3} - \lambda_{r1})(\lambda_{r3} - \lambda_{r2})} \quad (\text{B.53})$$

This type of reduction is necessary to show agreement with the Bateman form of the decay equations, as will be illustrated below. The equation for the third chain member can now be written as follows:

$$Q_{m3}(t) = \left[\frac{d_{13} \lambda_{r3} C_{m1}(0)}{(\lambda_{r3} - \lambda_{r1})} + \frac{d_{23} \lambda_{r2} d_{12} \lambda_{r3} C_{m1}(0)}{(\lambda_{r3} - \lambda_{r1})(\lambda_{r2} - \lambda_{r1})} \right] e^{-\lambda_{r1}t} + \left[\frac{d_{23} \lambda_{r3} C_{m2}(0)}{(\lambda_{r3} - \lambda_{r2})} - \frac{d_{23} \lambda_{r2} d_{12} \lambda_{r3} C_{m1}(0)}{(\lambda_{r3} - \lambda_{r2})(\lambda_{r2} - \lambda_{r1})} \right] e^{-\lambda_{r2}t} + \left[C_{m3}(0) - \frac{d_{13} \lambda_{r3} C_{m1}(0)}{(\lambda_{r3} - \lambda_{r1})} - \frac{d_{23} \lambda_{r3} C_{m2}(0)}{(\lambda_{r3} - \lambda_{r2})} + \frac{d_{23} \lambda_{r2} d_{12} \lambda_{r3} C_{m1}(0)}{(\lambda_{r3} - \lambda_{r1})(\lambda_{r3} - \lambda_{r2})} \right] e^{-\lambda_{r3}t} \quad (\text{B.54})$$

For the fourth chain member ($j=4$), the equation is

$$C_{m4}(t) = \lambda_{r4} \left[K_{41} e^{-\lambda_{r1}t} + K_{42} e^{-\lambda_{r2}t} + K_{43} e^{-\lambda_{r3}t} + K_{44} e^{-\lambda_{r4}t} \right] \quad (\text{B.55})$$

The first coefficient K_{41} is evaluated using Equation (B.4) as follows:

$$K_{41} = \frac{\sum_{p=1}^3 d_{p4} \lambda_{rp} K_{p1}}{\lambda_{r4} - \lambda_{r1}} = \frac{d_{14} \lambda_{r1} K_{11} + d_{24} \lambda_{r2} K_{21} + d_{34} \lambda_{r3} K_{31}}{\lambda_{r4} - \lambda_{r1}} \quad (\text{B.56})$$

Substituting the previous expressions for K_{11} , K_{21} , and K_{31} gives the following expression for K_{41} :

$$K_{41} = \frac{d_{14} C_{m1}(0)}{(\lambda_{r4} - \lambda_{r1})} + \frac{d_{24} \lambda_{r2} d_{12} C_{m1}(0)}{(\lambda_{r4} - \lambda_{r1})(\lambda_{r2} - \lambda_{r1})} + \frac{d_{34} \lambda_{r3} d_{13} C_{m1}(0)}{(\lambda_{r4} - \lambda_{r1})(\lambda_{r3} - \lambda_{r1})} + \frac{d_{34} \lambda_{r3} d_{23} \lambda_{r2} d_{12} C_{m1}(0)}{(\lambda_{r4} - \lambda_{r1})(\lambda_{r3} - \lambda_{r1})(\lambda_{r2} - \lambda_{r1})} \quad (\text{B.57})$$

The second coefficient of Equation (B.55), K_{42} , is evaluated using Equation (B.4) as follows:

$$K_{42} = \frac{\sum_{p=2}^3 d_{p4} \lambda_{rp} K_{p2}}{\lambda_{r4} - \lambda_{r2}} = \frac{d_{24} \lambda_{r2} K_{22} + d_{34} \lambda_{r3} K_{32}}{(\lambda_{r4} - \lambda_{r2})} \quad (\text{B.58})$$

Using the previously defined expressions for K_{22} and K_{32} gives the following equation for coefficient K_{42} :

$$K_{42} = \frac{d_{24} C_{m2}(0)}{(\lambda_{r4} - \lambda_{r2})} - \frac{d_{24} \lambda_{r2} d_{12} C_{m1}(0)}{(\lambda_{r4} - \lambda_{r2})(\lambda_{r2} - \lambda_{r1})} + \frac{d_{34} \lambda_{r3} d_{23} C_{m2}(0)}{(\lambda_{r4} - \lambda_{r2})(\lambda_{r3} - \lambda_{r2})} - \frac{d_{34} \lambda_{r3} d_{23} \lambda_{r2} d_{12} C_{m1}(0)}{(\lambda_{r4} - \lambda_{r2})(\lambda_{r3} - \lambda_{r2})(\lambda_{r2} - \lambda_{r1})} \quad (\text{B.59})$$

The third coefficient of Equation (B.55), K_{43} , is evaluated using Equation (B.4) as follows:

$$K_{43} = \frac{\sum_{p=3}^3 d_{p4} \lambda_{rp} K_{p3}}{\lambda_{r4} - \lambda_{r3}} = \frac{d_{34} \lambda_{r3} K_{33}}{\lambda_{r4} - \lambda_{r3}} \quad (\text{B.60})$$

Using the expression for K_{33} given by Equation (B.50) (the unsimplified form) gives the following expression for K_{43} :

$$K_{43} = \frac{d_{34} C_{m3}(0)}{\lambda_{r4} - \lambda_{r3}} - \frac{d_{34} \lambda_{r3} d_{13} C_{m1}(0)}{(\lambda_{r4} - \lambda_{r3})(\lambda_{r3} - \lambda_{r1})} - \frac{d_{34} \lambda_{r3} d_{23} \lambda_{r2} d_{12} C_{m1}(0)}{(\lambda_{r4} - \lambda_{r3})(\lambda_{r3} - \lambda_{r1})(\lambda_{r2} - \lambda_{r1})} - \frac{d_{34} \lambda_{r3} d_{23} C_{m2}(0)}{(\lambda_{r4} - \lambda_{r3})(\lambda_{r3} - \lambda_{r2})} + \frac{d_{34} \lambda_{r3} d_{23} \lambda_{r2} d_{12} C_{m1}(0)}{(\lambda_{r4} - \lambda_{r3})(\lambda_{r3} - \lambda_{r2})(\lambda_{r2} - \lambda_{r1})} \quad (\text{B.61})$$

The fourth coefficient of Equation (B.55), K_{44} , is evaluated using Equation (B.5) as follows:

$$K_{44} = \frac{C_{m4}(0)}{\lambda_{r4}} - \sum_{n=1}^3 K_{4n} = \frac{C_{m4}(0)}{\lambda_{r4}} - K_{41} - K_{42} - K_{43} \quad (\text{B.62})$$

Using the previous expressions for K_{41} , K_{42} , and K_{43} gives the following equation for K_{44} :

This equation for K_{44} contains 14 terms. Four pairs of these terms can be reduced using the identity of Equation (B.51).

$$\begin{aligned}
K_{44} = & \frac{C_{m4}(0)}{\lambda_{r4}} - \frac{d_{14} C_{m1}(0)}{\lambda_{r4} - \lambda_{r1}} - \frac{d_{24} \lambda_{r2} d_{12} C_{m1}(0)}{(\lambda_{r4} - \lambda_{r1})(\lambda_{r2} - \lambda_{r1})} \\
& - \frac{d_{34} \lambda_{r3} d_{13} C_{m1}(0)}{(\lambda_{r4} - \lambda_{r1})(\lambda_{r3} - \lambda_{r1})} - \frac{d_{34} \lambda_{r3} d_{23} \lambda_{r2} d_{12} C_{m1}(0)}{(\lambda_{r4} - \lambda_{r1})(\lambda_{r3} - \lambda_{r1})(\lambda_{r2} - \lambda_{r1})} \\
& - \frac{d_{24} C_{m2}(0)}{(\lambda_{r4} - \lambda_{r2})} + \frac{d_{24} \lambda_{r2} d_{12} C_{m1}(0)}{(\lambda_{r4} - \lambda_{r2})(\lambda_{r2} - \lambda_{r1})} \\
& - \frac{d_{34} \lambda_{r3} d_{23} C_{m2}(0)}{(\lambda_{r4} - \lambda_{r2})(\lambda_{r3} - \lambda_{r2})} + \frac{d_{34} \lambda_{r3} d_{23} \lambda_{r2} d_{12} C_{m1}(0)}{(\lambda_{r4} - \lambda_{r2})(\lambda_{r3} - \lambda_{r2})(\lambda_{r2} - \lambda_{r1})} \\
& - \frac{d_{34} C_{m3}(0)}{\lambda_{r4} - \lambda_{r3}} + \frac{d_{34} \lambda_{r3} d_{13} C_{m1}(0)}{(\lambda_{r4} - \lambda_{r3})(\lambda_{r3} - \lambda_{r1})} \\
& + \frac{d_{34} \lambda_{r3} d_{23} \lambda_{r2} d_{12} C_{m1}(0)}{(\lambda_{r4} - \lambda_{r3})(\lambda_{r3} - \lambda_{r1})(\lambda_{r2} - \lambda_{r1})} + \frac{d_{34} \lambda_{r3} d_{23} C_{m2}(0)}{(\lambda_{r4} - \lambda_{r3})(\lambda_{r3} - \lambda_{r2})} \\
& - \frac{d_{34} \lambda_{r3} d_{23} \lambda_{r2} d_{12} C_{m1}(0)}{(\lambda_{r4} - \lambda_{r3})(\lambda_{r3} - \lambda_{r2})(\lambda_{r2} - \lambda_{r1})}
\end{aligned} \tag{B.63}$$

The reductions are as follows:

terms 3 and 7 become

$$\frac{d_{24} \lambda_{r2} d_{12} C_{m1}(0)}{(\lambda_{r4} - \lambda_{r1})(\lambda_{r4} - \lambda_{r2})} \tag{B.64}$$

terms 4 and 11 become

$$\frac{d_{34} \lambda_{r3} d_{13} C_{m1}(0)}{(\lambda_{r4} - \lambda_{r1})(\lambda_{r4} - \lambda_{r3})} \tag{B.65}$$

terms 8 and 13 become

$$\frac{d_{34} \lambda_{r3} d_{23} C_{m2}(0)}{(\lambda_{r4} - \lambda_{r2})(\lambda_{r4} - \lambda_{r3})} \tag{B.66}$$

and terms 12 and 14 become

Appendix B

$$\frac{d_{34} \lambda_{r3} d_{23} \lambda_{r2} d_{12} C_{m1}(0)}{(\lambda_{r4} - \lambda_{r3})(\lambda_{r3} - \lambda_{r1})(\lambda_{r3} - \lambda_{r2})} \quad (\text{B.67})$$

At this point another algebraic identity is used to further reduce the number of terms. The following can be shown (by algebraic manipulation) to be true:

$$\frac{1}{(d-a)(c-a)(b-a)} - \frac{1}{(d-b)(c-b)(b-a)} + \frac{1}{(d-c)(c-a)(c-b)} = \frac{1}{(d-a)(d-b)(d-c)} \quad (\text{B.68})$$

Applying this identity to terms 5 and 9 of Equation (B.63) and Equation (B.67) with $a = \lambda_{r1}$, $b = \lambda_{r2}$, $c = \lambda_{r3}$, and $d = \lambda_{r4}$ gives the following expression for the three combined terms:

$$\frac{d_{34} \lambda_{r3} d_{23} \lambda_{r2} d_{12} C_{m1}(0)}{(\lambda_{r4} - \lambda_{r1})(\lambda_{r4} - \lambda_{r2})(\lambda_{r4} - \lambda_{r3})} \quad (\text{B.69})$$

Then, using the identity in Equation (B.51), two terms of Equation (B.61) for K_{43} can be combined. Terms 3 and 5 of Equation (B.61) become

$$\frac{d_{34} \lambda_{r3} d_{23} \lambda_{r2} d_{12} C_{m1}(0)}{(\lambda_{r4} - \lambda_{r3})(\lambda_{r3} - \lambda_{r1})(\lambda_{r3} - \lambda_{r2})} \quad (\text{B.70})$$

The final equation for the fourth chain member can now be written using expressions for K_{41} (Equation [B.57]), K_{42} (Equation [B.59]), K_{43} (Equation [B.61]), and K_{44} (Equation [B.63]) together with the term reductions (Equations [B.64] through [B.67]) and Equation (B.55) as follows:

$$\begin{aligned}
C_{m4}(t) = & \left[\frac{d_{14} \lambda_{r4} C_{m1}(0)}{\lambda_{r4} - \lambda_{r1}} + \frac{d_{24} \lambda_{r2} d_{12} \lambda_{r4} C_{m1}(0)}{(\lambda_{r4} - \lambda_{r1})(\lambda_{r2} - \lambda_{r1})} \right. \\
& + \left. \frac{d_{34} \lambda_{r3} d_{13} \lambda_{r4} C_{m1}(0)}{(\lambda_{r4} - \lambda_{r1})(\lambda_{r3} - \lambda_{r1})} + \frac{d_{34} \lambda_{r3} d_{23} \lambda_{r2} d_{12} \lambda_{r4} C_{m1}(0)}{(\lambda_{r4} - \lambda_{r1})(\lambda_{r3} - \lambda_{r1})(\lambda_{r2} - \lambda_{r1})} \right] e^{-\lambda_{r1}t} \\
& + \left[\frac{d_{24} \lambda_{r4} C_{m2}(0)}{\lambda_{r4} - \lambda_{r2}} - \frac{d_{24} \lambda_{r2} d_{12} \lambda_{r4} C_{m1}(0)}{(\lambda_{r4} - \lambda_{r2})(\lambda_{r2} - \lambda_{r1})} \right. \\
& + \left. \frac{d_{34} \lambda_{r3} d_{23} \lambda_{r4} C_{m2}(0)}{(\lambda_{r4} - \lambda_{r2})(\lambda_{r3} - \lambda_{r2})} - \frac{d_{34} \lambda_{r3} d_{23} \lambda_{r2} d_{12} \lambda_{r4} C_{m1}(0)}{(\lambda_{r4} - \lambda_{r2})(\lambda_{r3} - \lambda_{r2})(\lambda_{r2} - \lambda_{r1})} \right] e^{-\lambda_{r2}t} \\
& + \left[\frac{d_{34} \lambda_{r4} C_{m3}(0)}{\lambda_{r4} - \lambda_{r3}} - \frac{d_{34} \lambda_{r3} d_{13} \lambda_{r4} C_{m1}(0)}{(\lambda_{r4} - \lambda_{r3})(\lambda_{r3} - \lambda_{r1})} \right. \\
& - \left. \frac{d_{34} \lambda_{r3} d_{23} \lambda_{r4} C_{m2}(0)}{(\lambda_{r4} - \lambda_{r3})(\lambda_{r3} - \lambda_{r2})} + \frac{d_{34} \lambda_{r3} d_{23} \lambda_{r2} d_{12} \lambda_{r4} C_{m1}(0)}{(\lambda_{r4} - \lambda_{r3})(\lambda_{r3} - \lambda_{r1})(\lambda_{r3} - \lambda_{r2})} \right] e^{-\lambda_{r3}t} \\
& + \left[C_{m4}(0) - \frac{d_{14} \lambda_{r4} C_{m1}(0)}{\lambda_{r4} - \lambda_{r1}} + \frac{d_{24} \lambda_{r2} d_{12} \lambda_{r4} C_{m1}(0)}{(\lambda_{r4} - \lambda_{r1})(\lambda_{r4} - \lambda_{r2})} + \frac{d_{34} \lambda_{r3} d_{13} \lambda_{r4} C_{m1}(0)}{(\lambda_{r4} - \lambda_{r1})(\lambda_{r4} - \lambda_{r3})} \right. \\
& - \frac{d_{24} \lambda_{r4} C_{m2}(0)}{\lambda_{r4} - \lambda_{r2}} + \frac{d_{34} \lambda_{r3} d_{23} \lambda_{r4} C_{m2}(0)}{(\lambda_{r4} - \lambda_{r2})(\lambda_{r4} - \lambda_{r3})} - \frac{d_{34} \lambda_{r4} C_{m3}(0)}{\lambda_{r4} - \lambda_{r3}} \\
& \left. - \frac{d_{34} \lambda_{r3} d_{23} \lambda_{r2} d_{12} \lambda_{r4} C_{m1}(0)}{(\lambda_{r4} - \lambda_{r1})(\lambda_{r4} - \lambda_{r2})(\lambda_{r4} - \lambda_{r3})} \right] e^{-\lambda_{r4}t}
\end{aligned} \tag{B.71}$$

The above equations for chain-member activity as a function of time include all possible branching routes in a chain. For most radionuclide decay chains, only a few branches exist with most sequences being "straight chains" without branching. The original Bateman (1910) equations were developed for the case of decay chains without branching. As a further exercise in use of the decay processor equations, the equivalence between the Bateman equations and the above equations for a four-membered chain will be demonstrated. Equations (B.41), (B.43), (B.54) and (B.71) will be modified to represent a decay chain that has no branching (for comparison with the Bateman equations). The elimination of branching is implemented through the definition of the branching fractions. All transitions from one chain member to the next chain member are described by a branching fraction equal to 1.0. All branching fractions for which the subscripts differ by more than 1 are zero. The branching fractions for the example four-membered chain have the following values:

Appendix B

$$d_{12} = d_{23} = d_{34} = 1.0 \quad (\text{B.72})$$

$$d_{13} = d_{14} = d_{24} = 0.0 \quad (\text{B.73})$$

With these definitions, the equations for the four-membered chain without branching can be written as follows:

$$C_{m1}(t) = C_{m1}(0) e^{-\lambda_{r1}t} \quad (\text{B.74})$$

$$C_{m2}(t) = \frac{C_{m1}(0) \lambda_{r2}}{\lambda_{r2} - \lambda_{r1}} e^{-\lambda_{r1}t} + \left[C_{m2}(0) - \frac{\lambda_{r2} C_{m1}(0)}{\lambda_{r2} - \lambda_{r1}} \right] e^{-\lambda_{r2}t} \quad (\text{B.75})$$

$$\begin{aligned} C_{m3}(t) = & \frac{\lambda_{r2} \lambda_{r3} C_{m1}(0)}{(\lambda_{r3} - \lambda_{r1})(\lambda_{r2} - \lambda_{r1})} e^{-\lambda_{r1}t} \\ & + \left[\frac{\lambda_{r3} C_{m2}(0)}{\lambda_{r3} - \lambda_{r2}} - \frac{\lambda_{r2} \lambda_{r3} C_{m1}(0)}{(\lambda_{r3} - \lambda_{r2})(\lambda_{r2} - \lambda_{r1})} \right] e^{-\lambda_{r2}t} \\ & + \left[C_{m3}(0) - \frac{\lambda_{r3} C_{m2}(0)}{\lambda_{r3} - \lambda_{r2}} + \frac{\lambda_{r2} \lambda_{r3} C_{m1}(0)}{(\lambda_{r3} - \lambda_{r1})(\lambda_{r3} - \lambda_{r2})} \right] e^{-\lambda_{r3}t} \end{aligned} \quad (\text{B.76})$$

$$\begin{aligned}
C_{m4}(t) = & \frac{\lambda_{r3} \lambda_{r2} \lambda_{r4} C_{m1}(0)}{(\lambda_{r4} - \lambda_{r1})(\lambda_{r3} - \lambda_{r1})(\lambda_{r2} - \lambda_{r1})} e^{-\lambda_{r1}t} \\
& + \left[\frac{\lambda_{r3} \lambda_{r4} C_{m2}(0)}{(\lambda_{r4} - \lambda_{r2})(\lambda_{r3} - \lambda_{r2})} - \frac{\lambda_{r3} \lambda_{r2} \lambda_{r4} C_{m1}(0)}{(\lambda_{r4} - \lambda_{r2})(\lambda_{r3} - \lambda_{r2})(\lambda_{r2} - \lambda_{r1})} \right] e^{-\lambda_{r2}t} \\
& + \left[\frac{\lambda_{r4} C_{m3}(0)}{\lambda_{r4} - \lambda_{r3}} - \frac{\lambda_{r3} \lambda_{r4} C_{m2}(0)}{(\lambda_{r4} - \lambda_{r3})(\lambda_{r3} - \lambda_{r2})} + \frac{\lambda_{r3} \lambda_{r2} \lambda_{r4} C_{m1}(0)}{(\lambda_{r4} - \lambda_{r3})(\lambda_{r3} - \lambda_{r1})(\lambda_{r3} - \lambda_{r2})} \right] e^{-\lambda_{r3}t} \quad (B.77) \\
& + \left[C_{m4}(0) - \frac{\lambda_{r4} C_{m3}(0)}{\lambda_{r4} - \lambda_{r3}} + \frac{\lambda_{r3} \lambda_{r4} C_{m2}(0)}{(\lambda_{r4} - \lambda_{r3})(\lambda_{r4} - \lambda_{r2})} \right. \\
& \left. - \frac{\lambda_{r3} \lambda_{r2} \lambda_{r4} C_{m1}(0)}{(\lambda_{r4} - \lambda_{r1})(\lambda_{r4} - \lambda_{r2})(\lambda_{r4} - \lambda_{r3})} \right] e^{-\lambda_{r4}t}
\end{aligned}$$

The decay equations as originally published by Bateman (1910) in units of atoms are as follows:

chain member 1,

$$P = P_o e^{-\lambda_1 t} \quad (B.78)$$

chain member 2,

$$Q = \frac{\lambda_1 P_o}{\lambda_2 - \lambda_1} e^{-\lambda_1 t} + \left(\frac{\lambda_1 P_o}{\lambda_1 - \lambda_2} + Q_o \right) e^{-\lambda_2 t} \quad (B.79)$$

chain member 3,

$$\begin{aligned}
R = & \frac{\lambda_1 \lambda_2 P_o}{(\lambda_2 - \lambda_1)(\lambda_3 - \lambda_1)} e^{-\lambda_1 t} + \left[\frac{\lambda_1 \lambda_2 P_o}{(\lambda_1 - \lambda_2)(\lambda_3 - \lambda_2)} + \frac{\lambda_2 Q_o}{\lambda_3 - \lambda_2} \right] e^{-\lambda_2 t} \\
& + \left[\frac{\lambda_1 \lambda_2 P_o}{(\lambda_1 - \lambda_3)(\lambda_2 - \lambda_3)} + \frac{\lambda_2 Q_o}{\lambda_2 - \lambda_3} + R_o \right] e^{-\lambda_3 t} \quad (B.80)
\end{aligned}$$

chain member 4,

Appendix B

$$\begin{aligned}
 S = & \frac{\lambda_1 \lambda_2 \lambda_3 P_o}{(\lambda_2 - \lambda_1)(\lambda_3 - \lambda_1)(\lambda_4 - \lambda_1)} e^{-\lambda_1 t} \\
 & + \left[\frac{\lambda_1 \lambda_2 \lambda_3 P_o}{(\lambda_1 - \lambda_2)(\lambda_3 - \lambda_2)(\lambda_4 - \lambda_2)} + \frac{\lambda_2 \lambda_3 Q_o}{(\lambda_3 - \lambda_2)(\lambda_4 - \lambda_2)} \right] e^{-\lambda_2 t} \\
 & + \left[\frac{\lambda_1 \lambda_2 \lambda_3 P_o}{(\lambda_1 - \lambda_3)(\lambda_2 - \lambda_3)(\lambda_4 - \lambda_3)} + \frac{\lambda_2 \lambda_3 Q_o}{(\lambda_2 - \lambda_3)(\lambda_4 - \lambda_3)} + \frac{\lambda_3 R_o}{\lambda_4 - \lambda_3} \right] e^{-\lambda_3 t} \\
 & + \left[\frac{\lambda_1 \lambda_2 \lambda_3 P_o}{(\lambda_1 - \lambda_4)(\lambda_2 - \lambda_4)(\lambda_3 - \lambda_4)} + \frac{\lambda_2 \lambda_3 Q_o}{(\lambda_2 - \lambda_4)(\lambda_3 - \lambda_4)} + \frac{\lambda_3 R_o}{(\lambda_3 - \lambda_4)} + S_o \right] e^{-\lambda_4 t}
 \end{aligned} \tag{B.81}$$

Equations (B.74) through (B.77) can be seen by inspection to be equivalent to Equations (B.78) through (B.81), respectively, using the following nomenclature identities:

$$P = \frac{C_{m1}(t)}{\lambda_{r1}}, P_o = \frac{C_{m1}(0)}{\lambda_{r1}} \tag{B.82}$$

$$Q = \frac{C_{m2}(t)}{\lambda_{r2}}, Q_o = \frac{C_{m2}(0)}{\lambda_{r2}} \tag{B.83}$$

$$R = \frac{C_{m3}(t)}{\lambda_{r3}}, R_o = \frac{C_{m3}(0)}{\lambda_{r3}} \tag{B.84}$$

$$S = \frac{C_{m4}(t)}{\lambda_{r4}}, S_o = \frac{C_{m4}(0)}{\lambda_{r4}} \tag{B.85}$$

and

$$\lambda_i = \lambda_{ri}, i = 1, 2, 3, \text{ or } 4 \tag{B.86}$$

Note that expressions (B.82) through (B.86) include conversion from activity units to atom units as defined by Equation (B.27) with the constant, k , eliminated for clarity.

B.3 Time-Integral Operators

This section demonstrates the correctness of the time-integral operator notation, $S_e\{\}$ and $S\{\}$. The demonstrations involve integration of the results of the decay operators, $A_e\{\}$ and $A\{\}$, over a specific time period.

B.3.1 Time-Integral Operator with Removal, $S_e\{\}$

The time-integral operator with removal provides a solution to the integration of an activity or concentration over a specific time period. The basic equation for the activity or concentration in a medium as a function of time is given by Equation B.15. Integration of this equation over a time period is the action represented by the time-integral operator. This integration can be expressed as follows:

$$S_e\{C_{mj}, t_y\} = \int_0^{t_y} A_e\{C_{mj}, t\} dt = \int_0^{t_y} C_{mj}(t) dt \quad (B.87)$$

where $C_{mj}(t)$ = concentration factor for chain member radionuclide j evaluated at time t for medium m involving decay and removal (appropriate activity units, e.g., pCi/g)

t_y = example time period of integration (d)

and other terms are as previously defined. Using the expression of Equation B.15 the above equation can be integrated as follows:

$$\begin{aligned} \int_0^{t_y} C_{mj}(t) dt &= \int_0^{t_y} \lambda_{rj} \left[\sum_{n=1}^j K_{jn} e^{-\lambda_{en}t} \right] dt = \lambda_{rj} \sum_{n=1}^j K_{jn} \left[\int_0^{t_y} e^{-\lambda_{en}t} dt \right] \\ &= \lambda_{rj} \sum_{n=1}^j K_{jn} \left[\frac{e^{-\lambda_{en}t}}{-\lambda_{en}} \right]_0^{t_y} = \lambda_{rj} \sum_{n=1}^j K_{jn} \left[\frac{1 - e^{-\lambda_{en}t_y}}{\lambda_{en}} \right] \end{aligned} \quad (B.88)$$

where terms are as previously defined. The last term on the right side of Equation (B.88) can be seen by inspection to be equal to Equation B.15 with the substitution given by Expression (B.20). This demonstrates the correctness of the operator notation for $S_e\{\}$.

B.3.2 Time-Integral Operator, $S\{\}$

The correctness of the time-integral operator equations for the case without removal can be demonstrated in the same manner as shown above for the time-integral operator with removal. The starting activity or concentration is as provided by the decay operator without removal, $A\{\}$, with integration over a specified time. This integration can be expressed as follows:

$$S\{C_{mj}, t_y\} = \int_0^{t_y} A\{C_{mj}, t\} dt = \int_0^{t_y} C_{mj}(t) dt \quad (B.89)$$

where $C_{mj}(t)$ = concentration factor for chain member radionuclide j evaluated at time t for medium m involving decay without removal (appropriate activity units, e.g., pCi/g)

t_y = example time period of integration (d)

and other terms are as previously defined. Using the expression of Equation B.2 the above equation can be integrated as follows: the steps are analogous to Equation (B.88) with the radiological decay rate constant, λ_{rj} , replacing the decay rate constant with removal, λ_{ej} , as follows:

$$\begin{aligned} \int_0^{t_y} C_{mj}(t) dt &= \int_0^{t_y} \lambda_{rj} \left[\sum_{n=1}^j K_{jn} e^{-\lambda_{rn}t} \right] dt = \lambda_{rj} \sum_{n=1}^j K_{jn} \left[\int_0^{t_y} e^{-\lambda_{rn}t} dt \right] \\ &= \lambda_{rj} \sum_{n=1}^j K_{jn} \left[\frac{e^{-\lambda_{rn}t}}{-\lambda_{rn}} \right]_0^{t_y} = \lambda_{rj} \sum_{n=1}^j K_{jn} \left[\frac{1 - e^{-\lambda_{rn}t_y}}{\lambda_{rn}} \right] \end{aligned} \quad (B.90)$$

The last term on the right side of Equation (B.90) can be seen by inspection to be equal to Equation B.2 with the substitution given by Expression (B.8). This demonstrates the correctness of the operator notation for $S\{\}$.

B.4 Deposition, Accumulation Operators

This section demonstrates the correctness of the deposition accumulation operator notation, $R_e\{\}$ and $R\{\}$. The demonstration involves derivation of the solution to deposition at a constant rate with removal for the operator $R_e\{\}$. Correctness of the corresponding operator without removal is demonstrated by reduction of the equations for the case with removal.

B.4.1 Deposition Accumulation with Removal Operator, $R_e\{\}$

The agricultural pathway model requires evaluation of activity following deposition at a constant rate from application of irrigation water to plants and to soil. The deposition rate is constant because the concentration in the water is assumed to be represented by an annual average value, as generated from the water-use model for the residential scenario. The case of deposition to plant surfaces with removal by weathering is selected for illustration.

The change in concentration of a radionuclide on plant surfaces from deposition at a constant rate with weathering removal can be written as follows:

$$\frac{dC_{vj}}{dt} = R_{vj} + \sum_{n=1}^{j-1} d_{nj} \lambda_{rj} C_{vn} - (\lambda_w + \lambda_{rj}) C_{vj} \quad (B.91)$$

- where C_{vj} = concentration of radionuclide chain member j in plants per initial unit average concentration of parent radionuclide i in water (per Ci/kg wet-weight plant per pCi/L water)
- C_{vn} = concentration of precursor radionuclide chain member n in plants per initial unit average concentration of parent radionuclide i in water (pCi/kg wet-weight plant per pCi/L water)
- R_{vj} = constant deposition rate of radionuclide chain member j to plants from irrigation water application during the growing period for plant type v per initial unit average concentration of parent radionuclide i in water (pCi/d•kg wet-weight plant per pCi/L water)
- λ_{rj} = radioactive decay rate constant for radionuclide j (d^{-1})
- λ_w = rate constant for loss of material from plants (d^{-1})
- d_{nj} = fraction of precursor radionuclide n transitions that result in production of radionuclide chain member j (dimensionless).

The normalization to initial average activity of the parent radionuclide is included for consistency with representations given in Section 5. The solution to Equation (B.91) will be derived for the parent and first progeny radionuclides. Equation (B.91) can be written in terms of these chain members as follows, for the parent ($j=1$):

$$\frac{dC_{v1}}{dt} = R_{v1} - \lambda_{e1}C_{v1} \quad (\text{B.92})$$

and for the first progeny ($j=2$),

$$\frac{dC_{v2}}{dt} = R_{v2} + d_{12}\lambda_{r2}C_{v1} - \lambda_{e2}C_{v2} \quad (\text{B.93})$$

- where C_{v1} = concentration of parent radionuclide chain member ($j=1$) in plants per initial unit average concentration of parent radionuclide in water (pCi/kg wet-weight plant per pCi/L water)
- C_{v2} = concentration of first progeny radionuclide ($j=2$) in plants per initial unit average concentration of parent radionuclide in water (pCi/kg wet-weight plant per pCi/L water)
- d_{12} = fraction of precursor radionuclide 1 (parent) transitions that result in production of radionuclide chain member 2 (dimensionless)
- λ_{e1} = rate constant for removal and decay of radionuclide 1, evaluated as the sum of λ_w and λ_{r1} (d^{-1}).
- λ_{e2} = rate constant for removal and decay of radionuclide 2, evaluated as the sum of λ_w and λ_{r2} (d^{-1}).

The solution to Equation (B.92) is evaluated by first transferring terms containing the concentration of the parent radionuclide in the plant (C_{v1}) to the left side of the equation, and then multiplying by the integration factor, $e^{\lambda_{e1}t}$:

Appendix B

$$[dC_{v1} + \lambda_{e1} C_{v1} dt] e^{\lambda_{e1} t} = R_{v1} e^{\lambda_{e1} t} dt \quad (B.94)$$

The left side of the equation can be written as a differential, and the whole equation can then be integrated to give the following expression:

$$C_{v1} e^{\lambda_{e1} t} = \frac{R_{v1} e^{\lambda_{e1} t}}{\lambda_{e1}} + \text{Constant} \quad (B.95)$$

Evaluation of the constant of integration is performed using the condition that at $t = 0$, $C_{v1} = 0$ (no initial radionuclide in plant). The constant is given by

$$\text{Constant} = - \frac{R_{v1}}{\lambda_{e1}} \quad (B.96)$$

and the final expression for the amount of parent radionuclide in plants is given by

$$C_{v1} = \frac{R_{v1}}{\lambda_{e1}} [1 - e^{-\lambda_{e1} t}] \quad (B.97)$$

The solution of Equation (B.93) for the first progeny radionuclide can be found by first moving terms containing the plant concentration parameter, C_{v2} , to the left side of the equation and multiplying by the integration factor. The expression of Equation (B.97) is also substituted into Equation (B.93) for the parent concentration in the plant. The result of these actions is the following expression:

$$[dC_{v2} + \lambda_{e2} C_{v2} dt] e^{\lambda_{e2} t} = R_{v2} e^{\lambda_{e2} t} dt + \frac{d_{12} \lambda_{r2} R_{v1}}{\lambda_{e1}} \cdot [e^{\lambda_{e2} t} - e^{(\lambda_{e2} - \lambda_{e1}) t}] dt \quad (B.98)$$

The left side of this equation can be written as a differential, and the whole equation can be integrated to give the following expression:

$$C_{v2} e^{\lambda_{e2} t} = \frac{R_{v2}}{\lambda_{e2}} e^{\lambda_{e2} t} + \frac{d_{12} \lambda_{r2} R_{v1}}{\lambda_{e1} \lambda_{e2}} e^{\lambda_{e2} t} - \frac{d_{12} \lambda_{r2} R_{v1}}{\lambda_{e1} (\lambda_{e2} - \lambda_{e1})} e^{(\lambda_{e2} - \lambda_{e1}) t} + \text{Constant} \quad (B.99)$$

Multiplying through by the inverse of the integrating factor gives the following expression:

$$C_{v2} = \frac{R_{v2}}{\lambda_{e2}} + \frac{d_{12} \lambda_{r1} R_{v1}}{\lambda_{e1} \lambda_{e2}} - \frac{d_{12} \lambda_{r1} R_{v1}}{\lambda_{e1} (\lambda_{e2} - \lambda_{e1})} e^{-\lambda_{e1} t} + [\text{Constant}] e^{-\lambda_{e2} t} \quad (B.100)$$

The constant can be evaluated from the condition that $C_{v2} = 0$ at $t = 0$. Substituting this condition into Equation (B.100) gives the following expression for the constant:

$$\text{Constant} = -\frac{R_{v2}}{\lambda_{e2}} - \frac{d_{12}\lambda_{r2}R_{v1}}{\lambda_{e1}\lambda_{e2}} + \frac{d_{12}\lambda_{r2}R_{v1}}{\lambda_{e1}(\lambda_{e2} - \lambda_{e1})} \quad (\text{B.101})$$

Substituting this expression for the constant and combining terms results in the following expression for the amount of first progeny radionuclide on the plant as a function of time after start of irrigation:

$$C_{v2} = \frac{R_{v2}}{\lambda_{e2}} [1 - e^{-\lambda_{e2}t}] + \frac{d_{12}\lambda_{r2}R_{v1}}{\lambda_{e1}\lambda_{e2}} [1 - e^{-\lambda_{e2}t}] - \frac{d_{12}\lambda_{r2}R_{v1}}{\lambda_{e1}(\lambda_{e2} - \lambda_{e1})} [e^{-\lambda_{e1}t} - e^{-\lambda_{e2}t}] \quad (\text{B.102})$$

Some algebraic manipulation is required to convert Equation (B.102) to the form indicated by Equations (B.14) through (B.18) and (B.20). First, the difference of exponentials in the last term of Equation (B.102) is expanded using the following identity:

$$\frac{e^{-\lambda_{e1}t} - e^{-\lambda_{e2}t}}{\lambda_{e1}} = \frac{1 - e^{-\lambda_{e2}t}}{\lambda_{e1}} - \frac{1 - e^{-\lambda_{e1}t}}{\lambda_{e1}} \quad (\text{B.103})$$

Application of this identity results in the following expression for Equation (B.102):

$$C_{v2} = \frac{R_{v2}}{\lambda_{e2}} [1 - e^{-\lambda_{e2}t}] + \frac{d_{12}\lambda_{r2}R_{v1}}{\lambda_{e1}\lambda_{e2}} [1 - e^{-\lambda_{e2}t}] + \frac{d_{12}\lambda_{r2}R_{v1}}{\lambda_{e2} - \lambda_{e1}} \left[\frac{1 - e^{-\lambda_{e1}t}}{\lambda_{e1}} \right] - \frac{d_{12}\lambda_{r2}R_{v1}}{\lambda_{e2} - \lambda_{e1}} \left[\frac{1 - e^{-\lambda_{e2}t}}{\lambda_{e1}} \right] \quad (\text{B.104})$$

The second and last terms on the right side of this equation can be combined using the following algebraic identity:

$$\frac{1}{\lambda_{e1}} \left[\frac{1}{\lambda_{e2}} - \frac{1}{\lambda_{e2} - \lambda_{e1}} \right] = -\frac{1}{\lambda_{e2}[\lambda_{e2} - \lambda_{e1}]} \quad (\text{B.105})$$

The final expression for the concentration of the first progeny on the plant as a function of time can now be written:

$$C_{v2} = \frac{d_{12}\lambda_{r2}R_{v1}}{\lambda_{e2} - \lambda_{e1}} \left[\frac{1 - e^{-\lambda_{e1}t}}{\lambda_{e1}} \right] + \left[R_{v2} - \frac{d_{12}\lambda_{r2}R_{v1}}{\lambda_{e2} - \lambda_{e1}} \right] \left[\frac{1 - e^{-\lambda_{e2}t}}{\lambda_{e2}} \right] \quad (\text{B.106})$$

The equivalence can now be observed between the deposition accumulation with removal operator equations [Equations (B.14) through (B.18) and (B.20)] and Equation (B.93) for the parent and Equation (B.107) for the first progeny. Expansion of Equations (B.15) through (B.18) can be performed as demonstrated in Section B.2 for the first and second chain members. The equivalence can be seen by substitution of the constant deposition rates (R_{v1} and R_{v2}) for the initial activities (C_{m1} and C_{m2}) in Equations (B.16) and (B.18), and by substitution of the exponential term of Equation (B.15) by the expression indicated in Equation (B.20).

The explicit form of Equation (B.15) becomes

$$C_{mj}(t) = \lambda_{rj} \sum_{n=1}^j K_{jn} \left[\frac{1 - e^{-\lambda_{en}t}}{\lambda_{en}} \right] \quad (\text{B.107})$$

The deposition, accumulation operator with removal, $R_e\{\}$, is represented by this equation with constants, K_{jn} , defined by Equations (B.16), (B.17), and (B.18).

B.4.2 Deposition, Accumulation Operator, $R\{\}$

The deposition, accumulation operator (without removal), $R\{\}$, is represented by the general decay Equations (B.2) through (B.5) with the substitution indicated in Equation (B.10). The correctness of this representation can be shown by reduction of the equations for the corresponding case with removal, as shown to be correct in Section B.4.1. The reduction is performed by observing that the effective removal rate constant, λ_{ej} , is equal to the decay rate constant, λ_{rj} , when the removal rate constant, λ_w , is zero (see Equation [B.14]). By inspection, Equation (B.107) can be seen to reduce to the following:

$$C_{mj}(t) = \lambda_{rj} \sum_{n=1}^j K_{jn} \left[\frac{1 - e^{-\lambda_{rn}t}}{\lambda_{rn}} \right] \quad (\text{B.108})$$

Also, substitution of the decay rate constant for the effective removal rate constant can be seen to transform Equation (B.17) to Equation (B.4). This demonstrates that the equations for decay without removal (Equations [B.2] through [B.5]) with the substitution indicated in Equation (B.10) provide the correct representation for the deposition, accumulation operator, $R\{\}$.

B.5 Use of Deposition, Accumulation, and Time-Integral Equations

This section will show the correctness of the deposition, accumulation, and time-integration operators, $G_e\{\}$ and $G\{\}$.

B.5.1 Deposition, Accumulation, and Time-Integral with Removal Operator $G_e\{\}$

The correctness of the deposition accumulation with removal operator equations has been demonstrated in Section B.4. This section will demonstrate that time-integration of the deposition accumulation with removal operator, $R_e\{\}$, equations results in the defined equations for the deposition, accumulation, and time-integral with removal operator, $G_e\{\}$.

Integration of Equation (B.107) over time is equivalent to the calculations indicated by the deposition accumulation and time-integral operator with removal, $G_e\{\}$. Equation (B.107) can be integrated over a specific time period by integrating each term in the summation and evaluating the resulting expression between time zero and the end of the period of interest. This integration is indicated below for application of irrigation water to plants over the animal feeding period, t_{ff} . Using the nomenclature of Equation (5.38), Equation (B.107) can be expressed as follows:

$$\begin{aligned}
C_{w f j c} &= \left[\frac{G_e \{R_{w f j} t_{ff}\}}{t_{ff}} \right] = \frac{\lambda_{r j}}{t_{ff}} \sum_{n=1}^j K_{j n} \int_0^{t_{ff}} \left[\frac{1 - e^{-\lambda_{e n} t}}{\lambda_{e n}} \right] dt \\
&= \frac{\lambda_{r j}}{t_{ff}} \sum_{n=1}^j K_{j n} \left[\frac{t}{\lambda_{e n}} - \frac{e^{-\lambda_{e n} t}}{-\lambda_{e n}^2} \right]_{t=0}^{t_{ff}} \\
&= \frac{\lambda_{r j}}{t_{ff}} \sum_{n=1}^j \frac{K_{j n}}{\lambda_{e n}} \left[t_{ff} - \frac{(1 - e^{-\lambda_{e n} t_{ff}})}{\lambda_{e n}} \right]
\end{aligned} \tag{B.109}$$

where $C_{w f j c}$ = average concentration factor for radionuclide j in forage crop f , at time of consumption by animal, from direct deposition onto plant surfaces for an average unit concentration of parent radionuclide i in water (pCi/kg wet-weight plant per pCi/L water)

t_{ff} = period of feeding of forage crop f (d)

and other terms are as previously defined. Comparison of this expression with Equation (B.21) proves the validity of the substitution suggested in Equation (B.21). Note that in evaluation of the coefficients in Equation (B.109), $K_{j n}$, values for the deposition rate, $R_{w f j}$, of Equation (5.38) are used in place of $C_{m j}(0)$ in Equations (B.16) and (B.18).

B.5.2 Deposition, Accumulation, and Time-Integral (with Removal) Operator $G_e\{\}$

The deposition, accumulation, and time-integration operator without removal, $G\{\}$, is evaluated in the same manner as indicated by Equation (B.109), except that the removal term (λ_w in λ_e) is set to zero, so that occurrences of $\lambda_{e j}$ are replaced by $\lambda_{r j}$. Thus, the equations collapse to the general operator notation given by Equations (B.2) through (B.5) with the substitution indicated by Equation (B.12).

B.6 Water-Use Model for the Drinking Water Scenario

This section illustrates use of the operator equations for decay with removal to evaluate radionuclide activities in the water-use model. The example involves a two-membered decay chain applied to the drinking water scenario model (Section B.6.1). In this scenario, the water-use model has three compartments (as defined in Section 4.1), and no recycling of activity from the aquifer (box 3) to the surface (box 1) occurs. This section also shows the derivation of the equations for the parent activity in all three boxes, plus the equations for the activity of the first progeny in box 1 (Section B.6.2).

B.6.1 Demonstration of Equations for Drinking Water Water-Use Model

The primary purpose of this example is to show how the various parameters in the water-use model are applied in the operator setup. As indicated in Figure 4.3, each box of the water-use model contains compartments for each member of the decay chain. The total number of these compartments that must be accounted for in the operator

Appendix B

application is the product of the number of chain members and the number of boxes. For the current example, this is 6 (2 chain members times 3 boxes). These compartments are referred to in the example as "expanded chain member positions."

For each expanded chain member position, it is necessary to define all parameters required by the operator. These parameters include the radioactive decay constant, precursor indices, branching fractions, and removal rate constants. The water-use model involves transfer of activity from box 1 (surface soil) to box 2 (unsaturated-soil layer), and from box 2 to box 3 (aquifer). Removal from the aquifer is at a constant rate for all radionuclides, with total aquifer volume being removed in a 1-year period.

The steps in setting up the parameters for the operator equations are described by the following procedure using the example case. Following this description, derivation of equations for the example case will be given.

1. The expanded chain member positions are defined, and decay rate constants and radionuclide amounts are set for each expanded chain member position, as follows:

<u>Representation</u>	<u>Expanded Chain Member Position</u>	<u>Parameter Symbol</u>	<u>Decay Rate Constant (d^{-1})</u>	<u>Radionuclide Amount (atoms)</u>	<u>Equivalent Notation in Section 4.1.3</u>
Box 1, member 1	1	λ_{r1}	λ_{r1}	C_{m1}	C_{11}
Box 1, member 2	2	λ_{r2}	λ_{r2}	C_{m2}	C_{12}
Box 2, member 1	3	λ_{r3}	λ_{r1}	C_{m3}	C_{21}
Box 2, member 2	4	λ_{r4}	λ_{r2}	C_{m4}	C_{22}
Box 3, member 1	5	λ_{r5}	λ_{r1}	C_{m5}	C_{31}
Box 3, member 2	6	λ_{r6}	λ_{r2}	C_{m6}	C_{32}

Using the expanded chain member notation requires a slight modification to the definition of "precursor." Besides the standard usage to represent transition within a decay chain, there can now be transitions from one box to the next without radioactive decay. For example, radionuclide 1 in box 1 can be considered a precursor to radionuclide 1 in box 2 because leaching of radionuclide 1 from box 1 to box 2 will result in generation of radionuclide 1 in box 2, even though no radioactive decay has taken place.

2. The branching fractions and precursor indices are set for radioactive decay as follows:

<u>Parameter Symbol</u>	<u>Radioactive Transition Branching Fraction</u>			<u>Comments</u>
	<u>From</u>	<u>To</u>	<u>Set to:</u>	
d_{12}	1	2	d_{12}	Chain member 1 to chain member 2 within box 1.
d_{23}	2	3	0.0	No transitions from chain member 2 to chain member 1.
d_{34}	3	4	d_{12}	Chain member 1 to chain member 2 within box 2.
d_{45}	4	5	0.0	No transitions from chain member 2 to chain member 1.
d_{56}	5	6	d_{12}	Chain member 1 to chain member 2 within box 3.

3. For transfer of radionuclides between boxes, rate constants and effective branching fractions must be defined. The rate constant is treated as the general removal rate constant, λ_w , as defined in Equation (B.14). The definitions of the removal rate constants are as follows:

Parameter Symbol	Compartmental Transfer Loss Rate Constant			Comments
	From	To	Set to:	
λ_{w1}	1	3	L_{121}	Leakage of chain member 1 from box 1 to box 2.
λ_{w2}	2	4	L_{122}	Leakage of chain member 2 from box 1 to box 2.
λ_{w3}	3	5	L_{231}	Leakage of chain member 1 from box 2 to box 3.
λ_{w4}	4	6	L_{232}	Leakage of chain member 2 from box 2 to box 3.
λ_{w5}	5	-	w_d	Removal of chain member 1 from the aquifer.
λ_{w6}	6	-	w_d	Removal of chain member 2 from the aquifer.

The branching fractions associated with transfers between boxes are defined as follows:

Parameter Symbol	Compartmental Transfer Branching Fraction			Comments
	From	To	Set to:	
d_{13}	1	3	L_{121}/λ_{r1}	Chain member 1 leakage from box 1 to box 2.
d_{24}	2	4	L_{122}/λ_{r2}	Chain member 2 leakage from box 1 to box 2.
d_{35}	3	5	L_{231}/λ_{r1}	Chain member 1 leakage from box 2 to box 3.
d_{46}	4	6	L_{232}/λ_{r2}	Chain member 2 leakage from box 2 to box 3.

Compartmental transfer branching fractions (as defined above) can be understood by inspection of the differential equations for the three-box water-use model of Section 4.1 and those for the decay processor of Section B.1.2. For example, consider transfer of chain member 2 from box 1 to box 2. This transfer is represented by the branching fraction symbol, d_{24} . This transfer appears as the second term on the right side of Equation (4.11). The net transfer rate is L_{122} times the quantity in box 1 (C_{12}). This transfer is evaluated by the operator (for decay with removal, Section B.1.2) by the term within the summation of Equation (B.17). The operator generates a term of the form $d_{24} \lambda_{r2}$ times a quantity (represented by the coefficient K_{pn}). For the implementation to give the correct solution to the differential equations, it is necessary that

$$L_{122} = d_{24} \lambda_{r2} \quad (\text{B.110})$$

or

$$d_{24} = L_{122} / \lambda_{r2} \quad (\text{B.111})$$

as defined in step number 3, above.

All other branching fractions are set to zero, as these (and the branching fractions identified in item 2 above) are the only transfers defined in the water-use model. Branching fractions are not needed for removal from the aquifer.

The effective removal rate constant for each compartment is defined by Equation (B.14) as the sum of the removal rate constant and the radioactive decay rate constant as follows:

<u>Parameter Symbol</u>	<u>Removal from Compartment Number</u>	<u>Set to:</u>	<u>Comments</u>
λ_{e1}	1	$L_{121} + \lambda_{r1}$	Chain member 1 in box 1.
λ_{e2}	2	$L_{122} + \lambda_{r2}$	Chain member 2 in box 1.
λ_{e3}	3	$L_{231} + \lambda_{r1}$	Chain member 1 in box 2.
λ_{e4}	4	$L_{232} + \lambda_{r2}$	Chain member 2 in box 2.
λ_{e5}	5	$w_d + \lambda_{r1}$	Chain member 1 in box 3.
λ_{e6}	6	$w_d + \lambda_{r2}$	Chain member 2 in box 3.

The following discussion will illustrate how the above definitions are used in the general decay equations with removal (Equations [B.14] through [B.18]) to evaluate results for the water-use model of the drinking water scenario. The equation derivations are first performed using the nomenclature of the general decay equations, and then the substitutions of parameters as described above are made to show the final form of the equations. All derivations are shown for evaluation of the amount of a radionuclide present as a function of time, representative of the processor notation $A_{dk}\{C, t, \cdot\}$, where k represents the box of interest in the three-box water-use model.

Radionuclide 1 in Box 1: Expanded Chain Member Position 1

The activity of chain member 1 remaining in box 1 at time t is evaluated according to Equations (B.15) and (B.16) as follows:

$$C_{m1}(t) = \lambda_{r1} K_{11} e^{-\lambda_{e1}t} \quad (\text{B.112})$$

or

$$C_{m1}(t) = C_{m1}(0) e^{-\lambda_{e1}t} \quad (\text{B.113})$$

where terms follow the standard nomenclature and λ_{e1} is as defined in item 3 above.

Radionuclide 2 in Box 1: Expanded Chain Member Position 2

The activity of chain member 2 remaining in box 1 at time t is evaluated according to Equation (B.15) as follows:

$$C_{m2}(t) = \lambda_{r2} \left[K_{21} e^{-\lambda_{e1}t} + K_{22} e^{-\lambda_{e2}t} \right] \quad (\text{B.114})$$

Coefficient K_{21} is evaluated using Equation (B.17) as follows:

$$K_{21} = \frac{\sum_{p=1}^1 d_{p2} \lambda_{rp} K_{p1}}{\lambda_{e2} - \lambda_{e1}} = \frac{d_{12} \lambda_{r1} K_{11}}{\lambda_{e2} - \lambda_{e1}} \quad (\text{B.115})$$

and

$$K_{11} = \frac{C_{m1}(0)}{\lambda_{r1}} \quad (\text{B.116})$$

Then, K_{21} is written as:

$$K_{21} = \frac{d_{12}C_{m1}(0)}{\lambda_{e2} - \lambda_{e1}} \quad (\text{B.117})$$

where terms follow the standard nomenclature and λ_{e2} is as defined in item 3 above.

Coefficient K_{22} is evaluated using Equation (B.18) as follows:

$$K_{22} = \frac{C_{m2}(0)}{\lambda_{r2}} - \sum_{n=1}^1 K_{2n} = \frac{C_{m2}(0)}{\lambda_{r2}} - K_{21} \quad (\text{B.118})$$

and

$$K_{22} = \frac{C_{m2}(0)}{\lambda_{r2}} - \frac{d_{12}C_{m1}(0)}{\lambda_{e2} - \lambda_{e1}} \quad (\text{B.119})$$

The activity of chain member 2 at time t can now be written as

$$C_{m2}(t) = \frac{d_{12}\lambda_{r2}C_{m1}(0)}{\lambda_{e2} - \lambda_{e1}} e^{-\lambda_{e1}t} + \left[C_{m2}(0) - \frac{d_{12}\lambda_{r2}C_{m1}(0)}{\lambda_{e2} - \lambda_{e1}} \right] e^{-\lambda_{e2}t} \quad (\text{B.120})$$

Radionuclide 1 in Box 2: Expanded Chain Member Position 3

The activity of chain member 1 remaining in box 2 at time t is evaluated according to Equation (B.15) as follows:

$$C_{m3}(t) = \lambda_{r3} \left[K_{31} e^{-\lambda_{e1}t} + K_{32} e^{-\lambda_{e2}t} + K_{33} e^{-\lambda_{e3}t} \right] \quad (\text{B.121})$$

Coefficient K_{31} is evaluated using Equation (B.17) as follows:

$$K_{31} = \frac{\sum_{p=1}^2 d_{p3}\lambda_{rp}K_{p1}}{\lambda_{e3} - \lambda_{e1}} = \frac{d_{13}\lambda_{r1}K_{11}}{\lambda_{e3} - \lambda_{e1}} + \frac{d_{23}\lambda_{r2}K_{21}}{\lambda_{e3} - \lambda_{e1}} \quad (\text{B.122})$$

Substituting previous expressions for K_{11} and K_{21} into Equation (B.122) gives the following expression for coefficient K_{31} :

Appendix B

$$K_{31} = \frac{d_{13} C_{m1}(0)}{\lambda_{e3} - \lambda_{e1}} + \frac{d_{23} \lambda_{r2} d_{12} C_{m1}(0)}{(\lambda_{e3} - \lambda_{e1})(\lambda_{e2} - \lambda_{e1})} \quad (\text{B.123})$$

This expression can be further reduced by noting that the branching fraction d_{23} is zero, as indicated in item 2 above. Equation (B.123) then reduces to the following:

$$K_{31} = \frac{d_{13} C_{m1}(0)}{\lambda_{e3} - \lambda_{e1}} \quad (\text{B.124})$$

The second coefficient in Equation (B.121) is evaluated using Equation (B.17) as follows:

$$K_{32} = \frac{\sum_{p=2}^2 d_{p3} \lambda_{rp} K_{p2}}{\lambda_{e3} - \lambda_{e2}} = \frac{d_{23} \lambda_{r2} K_{22}}{\lambda_{e3} - \lambda_{e2}} \quad (\text{B.125})$$

However, as before, the branching fraction d_{23} is zero and K_{32} is also zero. The expression for K_{33} is evaluated using Equation (B.18) as follows:

$$K_{33} = \frac{C_{m3}(0)}{\lambda_{r3}} - \sum_{n=1}^2 K_{3n} = \frac{C_{m3}(0)}{\lambda_{r3}} - K_{31} - K_{32} \quad (\text{B.126})$$

Using the previous expression for K_{31} , the following expression for K_{33} is obtained:

$$K_{33} = \frac{C_{m3}(0)}{\lambda_{r3}} - \frac{d_{13} C_{m1}(0)}{\lambda_{e3} - \lambda_{e1}} \quad (\text{B.127})$$

The amount of radionuclide 1 in box 2 can now be written as follows:

$$C_{m3}(t) = \frac{d_{13} \lambda_{r3} C_{m1}(0)}{\lambda_{e3} - \lambda_{e1}} e^{-\lambda_{e1}t} + \left[C_{m3}(0) - \frac{d_{13} \lambda_{r3} C_{m1}(0)}{\lambda_{e3} - \lambda_{e1}} \right] e^{-\lambda_{e3}t} \quad (\text{B.128})$$

This expression can be rewritten by substituting the definition for parameter d_{13} from the table in item 3 above ($d_{13} = L_{121}/\lambda_{r1}$ and $\lambda_{r3} = \lambda_{r1}$) to give the following equation:

$$C_{m3}(t) = \frac{L_{121} C_{m1}(0)}{\lambda_{e3} - \lambda_{e1}} e^{-\lambda_{e1}t} + \left[C_{m3}(0) - \frac{L_{121} C_{m1}(0)}{\lambda_{e3} - \lambda_{e1}} \right] e^{-\lambda_{e3}t} \quad (\text{B.129})$$

Radionuclide 2 in Box 2: Expanded Chain Member Position 4

The amount of chain member 2 remaining in box 2 at time t is evaluated according to Equation (B.15) as follows:

$$C_{m4}(t) = \lambda_{r4} \left[K_{41} e^{-\lambda_{e1}t} + K_{42} e^{-\lambda_{e2}t} + K_{43} e^{-\lambda_{e3}t} + K_{44} e^{-\lambda_{e4}t} \right] \quad (\text{B.130})$$

Coefficient K_{41} is evaluated using Equation (B.17) as follows:

$$K_{41} = \frac{\sum_{p=1}^3 d_{p4} \lambda_{rp} K_{p1}}{\lambda_{e4} - \lambda_{e1}} \quad (\text{B.131})$$

and

$$K_{41} = \frac{d_{14} \lambda_{r1} K_{11}}{\lambda_{e4} - \lambda_{e1}} + \frac{d_{24} \lambda_{r2} K_{21}}{\lambda_{e4} - \lambda_{e1}} + \frac{d_{34} \lambda_{r3} K_{31}}{\lambda_{e4} - \lambda_{e1}} \quad (\text{B.132})$$

Using previous expressions for K_{11} , K_{21} , and K_{31} , and noting that d_{14} is zero, the following equation for K_{41} is obtained:

$$K_{41} = \frac{d_{24} \lambda_{r2} d_{12} C_{m1}(0)}{(\lambda_{e4} - \lambda_{e1})(\lambda_{e2} - \lambda_{e1})} + \frac{d_{34} \lambda_{r3} d_{13} C_{m1}(0)}{(\lambda_{e4} - \lambda_{e1})(\lambda_{e3} - \lambda_{e1})} \quad (\text{B.133})$$

Coefficient K_{42} is evaluated using Equation (B.17) as follows:

$$K_{42} = \frac{\sum_{p=2}^3 d_{p4} \lambda_{rp} K_{p2}}{\lambda_{e4} - \lambda_{e2}} = \frac{d_{24} \lambda_{r2} K_{22}}{\lambda_{e4} - \lambda_{e2}} + \frac{d_{34} \lambda_{r3} K_{32}}{\lambda_{e4} - \lambda_{e2}} \quad (\text{B.134})$$

Using previous expressions for K_{22} and noting that K_{32} is zero, the following equation for K_{42} is obtained:

$$K_{42} = \frac{d_{24} C_{m2}(0)}{\lambda_{e4} - \lambda_{e2}} - \frac{d_{24} \lambda_{r2} d_{12} C_{m1}(0)}{(\lambda_{e4} - \lambda_{e2})(\lambda_{e2} - \lambda_{e1})} \quad (\text{B.135})$$

Coefficient K_{43} is evaluated using Equation (B.17) as follows:

$$K_{43} = \frac{\sum_{p=3}^3 d_{p4} \lambda_{rp} K_{p3}}{\lambda_{e4} - \lambda_{e3}} = \frac{d_{34} \lambda_{r3} K_{33}}{\lambda_{e4} - \lambda_{e3}} \quad (\text{B.136})$$

Using previous expression for K_{33} , the following equation for K_{43} is obtained:

$$K_{43} = \frac{d_{34} C_{m3}(0)}{\lambda_{e4} - \lambda_{e3}} - \frac{d_{34} \lambda_{r3} d_{13} C_{m1}(0)}{(\lambda_{e4} - \lambda_{e3})(\lambda_{e3} - \lambda_{e1})} \quad (\text{B.137})$$

The final coefficient for radionuclide 2 in box 2 is evaluated using Equation (B.18):

$$K_{44} = \frac{C_{m4}(0)}{\lambda_{r4}} - K_{41} - K_{42} - K_{43} \quad (\text{B.138})$$

Using the previous expressions for K_{41} , K_{42} , and K_{43} , coefficient K_{44} can be written as follows:

$$\begin{aligned} K_{44} = & \frac{C_{m4}(0)}{\lambda_{r4}} - \frac{d_{24} \lambda_{r2} d_{12} C_{m1}(0)}{(\lambda_{e4} - \lambda_{e1})(\lambda_{e2} - \lambda_{e1})} \\ & - \frac{d_{34} \lambda_{r3} d_{13} C_{m1}(0)}{(\lambda_{e4} - \lambda_{e1})(\lambda_{e3} - \lambda_{e1})} - \frac{d_{24} C_{m2}(0)}{\lambda_{e4} - \lambda_{e2}} \\ & + \frac{d_{24} \lambda_{r2} d_{12} C_{m1}(0)}{(\lambda_{e4} - \lambda_{e2})(\lambda_{e2} - \lambda_{e1})} - \frac{d_{34} C_{m3}(0)}{\lambda_{e4} - \lambda_{e3}} \\ & + \frac{d_{34} \lambda_{r3} d_{13} C_{m1}(0)}{(\lambda_{e4} - \lambda_{e3})(\lambda_{e3} - \lambda_{e1})} \end{aligned} \quad (\text{B.139})$$

Four terms on the right side of Equation (B.139) can be combined using the algebraic identity of Equation (B.51): terms 2 and 5 become

$$\frac{d_{24} \lambda_{r2} d_{12} C_{m1}(0)}{(\lambda_{e4} - \lambda_{e1})(\lambda_{e4} - \lambda_{e2})} \quad (\text{B.140})$$

terms 3 and 7 become

$$\frac{d_{34} \lambda_{r3} d_{13} C_{m1}(0)}{(\lambda_{e4} - \lambda_{e1})(\lambda_{e4} - \lambda_{e3})} \quad (\text{B.141})$$

Substituting these expressions into Equation (B.139) and using expressions for K_{41} , K_{42} , K_{43} , and K_{44} in Equation (B.130), the amount of radionuclide 2 in box 2 at time t can be written as follows:

$$\begin{aligned}
C_{m4}(t) = & \left[\frac{d_{24}\lambda_{r2}d_{12}\lambda_{r4}C_{m1}(0)}{(\lambda_{e4} - \lambda_{e1})(\lambda_{e2} - \lambda_{e1})} + \frac{d_{34}\lambda_{r3}d_{13}\lambda_{r4}C_{m1}(0)}{(\lambda_{e4} - \lambda_{e1})(\lambda_{e3} - \lambda_{e1})} \right] e^{-\lambda_{e1}t} \\
& + \left[\frac{d_{24}\lambda_{r4}C_{m2}(0)}{\lambda_{e4} - \lambda_{e2}} - \frac{d_{24}\lambda_{r2}d_{12}\lambda_{r4}C_{m1}(0)}{(\lambda_{e4} - \lambda_{e2})(\lambda_{e2} - \lambda_{e1})} \right] e^{-\lambda_{e2}t} \\
& + \left[\frac{d_{34}\lambda_{r4}C_{m3}(0)}{\lambda_{e4} - \lambda_{e3}} - \frac{d_{34}\lambda_{r3}d_{13}\lambda_{r4}C_{m1}(0)}{(\lambda_{e4} - \lambda_{e3})(\lambda_{e3} - \lambda_{e1})} \right] e^{-\lambda_{e3}t} \\
& + \left[C_{m4}(0) + \frac{d_{24}\lambda_{r2}d_{12}\lambda_{r4}C_{m1}(0)}{(\lambda_{e4} - \lambda_{e1})(\lambda_{e4} - \lambda_{e2})} - \frac{d_{24}\lambda_{r4}C_{m2}(0)}{\lambda_{e4} - \lambda_{e2}} \right. \\
& \left. + \frac{d_{34}\lambda_{r3}d_{13}\lambda_{r4}C_{m1}(0)}{(\lambda_{e4} - \lambda_{e1})(\lambda_{e4} - \lambda_{e3})} - \frac{d_{34}\lambda_{r4}C_{m3}(0)}{\lambda_{e4} - \lambda_{e3}} \right] e^{-\lambda_{e4}t}
\end{aligned} \tag{B.142}$$

Substitution of expressions for d_{24} and d_{13} from item 3 above ($d_{24} = L_{122}/\lambda_{r2}$ and $d_{13} = L_{121}/\lambda_{r1}$), d_{34} from item 2 above ($d_{34} = d_{12}$), and λ_{r3} , and λ_{r4} from item 1 above, into Equation (B.142) gives the following equation for the amount of radionuclide 2 in box 2 as a function of time:

$$\begin{aligned}
C_{m4}(t) = & \left[\frac{L_{122}d_{12}\lambda_{r2}C_{m1}(0)}{(\lambda_{e4} - \lambda_{e1})(\lambda_{e2} - \lambda_{e1})} + \frac{d_{12}L_{121}\lambda_{r2}C_{m1}(0)}{(\lambda_{e4} - \lambda_{e1})(\lambda_{e3} - \lambda_{e1})} \right] e^{-\lambda_{e1}t} \\
& + \left[\frac{L_{122}C_{m2}(0)}{\lambda_{e4} - \lambda_{e2}} - \frac{L_{122}d_{12}\lambda_{r2}C_{m1}(0)}{(\lambda_{e4} - \lambda_{e2})(\lambda_{e2} - \lambda_{e1})} \right] e^{-\lambda_{e2}t} \\
& + \left[\frac{d_{12}\lambda_{r2}C_{m3}(0)}{\lambda_{e4} - \lambda_{e3}} - \frac{d_{12}L_{121}\lambda_{r2}C_{m1}(0)}{(\lambda_{e4} - \lambda_{e3})(\lambda_{e3} - \lambda_{e1})} \right] e^{-\lambda_{e3}t} \\
& + \left[C_{m4}(0) + \frac{L_{122}d_{12}\lambda_{r2}C_{m1}(0)}{(\lambda_{e4} - \lambda_{e1})(\lambda_{e4} - \lambda_{e2})} - \frac{L_{122}C_{m2}(0)}{\lambda_{e4} - \lambda_{e2}} \right. \\
& \left. + \frac{d_{12}L_{121}\lambda_{r2}C_{m1}(0)}{(\lambda_{e4} - \lambda_{e1})(\lambda_{e4} - \lambda_{e3})} - \frac{d_{12}\lambda_{r2}C_{m3}(0)}{\lambda_{e4} - \lambda_{e3}} \right] e^{-\lambda_{e4}t}
\end{aligned} \tag{B.143}$$

Radionuclide 1 in Box 3: Expanded Chain Member Position 5

The activity of chain member 1 remaining in box 3 at time t is evaluated according to Equation (B.15) as follows:

$$C_{m5}(t) = \lambda_{r5} \left[K_{51} e^{-\lambda_{e1}t} + K_{52} e^{-\lambda_{e2}t} + K_{53} e^{-\lambda_{e3}t} + K_{54} e^{-\lambda_{e4}t} + K_{55} e^{-\lambda_{e5}t} \right] \quad (\text{B.144})$$

Coefficient K_{51} is evaluated using Equation (B.17) as follows:

$$K_{51} = \frac{\sum_{p=1}^4 d_{p5} \lambda_{rp} K_{p1}}{\lambda_{e5} - \lambda_{e1}} = \frac{d_{15} \lambda_{r1} K_{11}}{\lambda_{e5} - \lambda_{e1}} + \frac{d_{25} \lambda_{r2} K_{21}}{\lambda_{e5} - \lambda_{e1}} + \frac{d_{35} \lambda_{r3} K_{31}}{\lambda_{e5} - \lambda_{e1}} + \frac{d_{45} \lambda_{r4} K_{41}}{\lambda_{e5} - \lambda_{e1}} \quad (\text{B.145})$$

The branching fractions d_{15} and d_{25} are zero because there is no direct transfer from box 1 to box 3. Also, the branching fraction d_{45} is zero because there is no production of radionuclide 1 from radionuclide 2. With these simplifications, and use of the previous expression for K_{13} , Equation (B.145) can be reduced to the following:

$$K_{51} = \frac{d_{35} \lambda_{r3} K_{31}}{\lambda_{e5} - \lambda_{e1}} = \frac{d_{35} \lambda_{r3} d_{13} C_{m1}(0)}{(\lambda_{e5} - \lambda_{e1})(\lambda_{e3} - \lambda_{e1})} \quad (\text{B.146})$$

The second coefficient of Equation (B.144), K_{52} , is evaluated using Equation (B.17) as follows:

$$K_{52} = \frac{\sum_{p=2}^4 d_{p5} \lambda_{rp} K_{p2}}{\lambda_{e5} - \lambda_{e2}} = \frac{d_{25} \lambda_{r2} K_{22}}{\lambda_{e5} - \lambda_{e2}} + \frac{d_{35} \lambda_{r3} K_{32}}{\lambda_{e5} - \lambda_{e2}} + \frac{d_{45} \lambda_{r4} K_{42}}{\lambda_{e5} - \lambda_{e2}} \quad (\text{B.147})$$

Because K_{32} , d_{25} , and d_{45} are zero (as before), the expression reduces to zero:

$$K_{52} = 0 \quad (\text{B.148})$$

The third coefficient of Equation (B.144), K_{53} , is evaluated using Equation (B.17) as follows:

$$K_{53} = \frac{\sum_{p=3}^4 d_{p5} \lambda_{rp} K_{p3}}{\lambda_{e5} - \lambda_{e3}} = \frac{d_{35} \lambda_{r3} K_{33}}{\lambda_{e5} - \lambda_{e3}} + \frac{d_{45} \lambda_{r4} K_{43}}{\lambda_{e5} - \lambda_{e3}} \quad (\text{B.149})$$

As before, d_{45} is zero and the expression reduces to the following:

$$K_{53} = \frac{d_{35} C_{m3}(0)}{\lambda_{e5} - \lambda_{e3}} - \frac{d_{35} \lambda_{r3} d_{13} C_{m1}(0)}{(\lambda_{e5} - \lambda_{e3})(\lambda_{e3} - \lambda_{e1})} \quad (\text{B.150})$$

The fourth coefficient of Equation (B.144), K_{54} , is evaluated using Equation (B.17) as follows:

$$K_{54} = \frac{\sum_{p=4}^4 d_{p5} \lambda_{rp} K_{p4}}{\lambda_{e5} - \lambda_{e4}} = \frac{d_{45} \lambda_{r4} K_{44}}{\lambda_{e5} - \lambda_{e4}} \quad (\text{B.151})$$

As before, d_{45} is zero and K_{54} reduces to zero:

$$K_{54} = 0 \quad (\text{B.152})$$

The last coefficient of Equation (B.144), K_{55} , is evaluated using Equation (B.18) as follows:

$$K_{55} = \frac{C_{m5}(0)}{\lambda_{r5}} - K_{51} - K_{52} - K_{53} - K_{54} \quad (\text{B.153})$$

Using the previous expressions for the first four coefficients of Equation (B.144) gives the following expression for K_{55} :

$$\begin{aligned} K_{55} &= \frac{C_{m5}(0)}{\lambda_{r5}} - \frac{d_{35} \lambda_{r3} d_{13} C_{m1}(0)}{(\lambda_{e5} - \lambda_{e1})(\lambda_{e3} - \lambda_{e1})} + 0 \\ &\quad - \frac{d_{35} C_{m3}(0)}{\lambda_{e5} - \lambda_{e3}} + \frac{d_{35} \lambda_{r3} d_{13} C_{m1}(0)}{(\lambda_{e5} - \lambda_{e3})(\lambda_{e3} - \lambda_{e1})} + 0 \end{aligned} \quad (\text{B.154})$$

Using the algebraic identity of Equation (B.51), the second and fourth terms for K_{55} can be combined to give the following expression:

$$\frac{d_{35} \lambda_{r3} d_{13} C_{m1}(0)}{(\lambda_{e5} - \lambda_{e1})(\lambda_{e5} - \lambda_{e3})} \quad (\text{B.155})$$

The activity of radionuclide 1 in box 3 as a function of time can now be written from Equation (B.144) and the above expressions for the coefficients as follows:

$$\begin{aligned}
 C_{m5}(t) = & \frac{d_{35} \lambda_{r3} d_{13} \lambda_{r5} C_{m1}(0)}{(\lambda_{e5} - \lambda_{e1})(\lambda_{e3} - \lambda_{e1})} e^{-\lambda_{e1}t} \\
 & + \left[\frac{d_{35} \lambda_{r5} C_{m3}(0)}{\lambda_{e5} - \lambda_{e3}} - \frac{d_{35} \lambda_{r3} d_{13} \lambda_{r5} C_{m1}(0)}{(\lambda_{e5} - \lambda_{e3})(\lambda_{e3} - \lambda_{e1})} \right] e^{-\lambda_{e3}t} \\
 & + \left[C_{m5}(0) - \frac{d_{35} \lambda_{r5} C_{m3}(0)}{\lambda_{e5} - \lambda_{e3}} + \frac{d_{35} \lambda_{r3} d_{13} \lambda_{r5} C_{m1}(0)}{(\lambda_{e5} - \lambda_{e1})(\lambda_{e5} - \lambda_{e3})} \right] e^{-\lambda_{e5}t}
 \end{aligned} \tag{B.156}$$

Using expressions for d_{13} and d_{35} from item 3 above ($d_{13} = L_{121}/\lambda_{r1}$ and $d_{35} = L_{231}/\lambda_{r1}$), and $\lambda_{r5} = \lambda_{r3} = \lambda_{r1}$, the final expression for the amount of radionuclide 1 in box 3 can be expressed as follows:

$$\begin{aligned}
 C_{m5}(t) = & \frac{L_{231} L_{121} C_{m1}(0)}{(\lambda_{e5} - \lambda_{e1})(\lambda_{e3} - \lambda_{e1})} e^{-\lambda_{e1}t} \\
 & + \left[\frac{L_{231} C_{m3}(0)}{\lambda_{e5} - \lambda_{e3}} - \frac{L_{231} L_{121} C_{m1}(0)}{(\lambda_{e5} - \lambda_{e3})(\lambda_{e3} - \lambda_{e1})} \right] e^{-\lambda_{e3}t} \\
 & + \left[C_{m5}(0) - \frac{L_{231} C_{m3}(0)}{\lambda_{e5} - \lambda_{e3}} + \frac{L_{231} L_{121} C_{m1}(0)}{(\lambda_{e5} - \lambda_{e1})(\lambda_{e5} - \lambda_{e3})} \right] e^{-\lambda_{e5}t}
 \end{aligned} \tag{B.157}$$

Further modifications could be made to the above equation by substituting the following expressions for terms in the denominators of the coefficient terms:

$$\lambda_{e3} - \lambda_{e1} = \lambda_{r1} + L_{231} - \lambda_{r1} - L_{121} = L_{231} - L_{121} \tag{B.158}$$

$$\lambda_{e5} - \lambda_{e3} = \lambda_{r1} + w_d - \lambda_{r1} - L_{231} = w_d - L_{231} \tag{B.159}$$

Making these substitutions in Equation (B.157) can be done, but will not result in a simpler expression. The important point to note from Equations (B.158) and (B.159) is that each term must be non-zero, implying that the leakage rate constants must not be the same between any two boxes:

$$L_{121} \neq L_{231} \text{ and } L_{231} \neq w_d \tag{B.160}$$

Radionuclide 2 in Box 3: Expanded Chain Member Position 6

Details of the derivation of equations for this case are not presented. The derivations are performed in a manner similar to the previous cases. The final result of the derivation is given in the following equation for the amount of radionuclide 2 in box 3 as a function of time:

$$\begin{aligned}
C_{m6}(t) = & \left[\frac{L_{232} L_{122} d_{12} \lambda_{r2} C_{m1}(0)}{(\lambda_{e6} - \lambda_{e1})(\lambda_{e4} - \lambda_{e1})(\lambda_{e2} - \lambda_{e1})} \right. \\
& + \frac{L_{232} d_{12} \lambda_{r2} L_{121} C_{m1}(0)}{(\lambda_{e6} - \lambda_{e1})(\lambda_{e4} - \lambda_{e1})(\lambda_{e3} - \lambda_{e1})} + \left. \frac{d_{12} \lambda_{r2} L_{231} L_{121} C_{m1}(0)}{(\lambda_{e6} - \lambda_{e1})(\lambda_{e5} - \lambda_{e1})(\lambda_{e3} - \lambda_{e1})} \right] e^{-\lambda_{e1}t} \\
& + \left[\frac{L_{232} L_{122} C_{m2}(0)}{(\lambda_{e6} - \lambda_{e2})(\lambda_{e4} - \lambda_{e2})} - \frac{L_{232} L_{122} d_{12} \lambda_{r2} C_{m1}(0)}{(\lambda_{e6} - \lambda_{e2})(\lambda_{e4} - \lambda_{e2})(\lambda_{e2} - \lambda_{e1})} \right] e^{-\lambda_{e2}t} \\
& + \left[\frac{L_{232} d_{12} \lambda_{r2} C_{m3}(0)}{(\lambda_{e6} - \lambda_{e3})(\lambda_{e4} - \lambda_{e3})} - \frac{L_{232} d_{12} \lambda_{r2} L_{121} C_{m1}(0)}{(\lambda_{e6} - \lambda_{e3})(\lambda_{e4} - \lambda_{e3})(\lambda_{e3} - \lambda_{e1})} \right. \\
& + \left. \frac{d_{12} \lambda_{r2} L_{231} C_{m3}(0)}{(\lambda_{e6} - \lambda_{e3})(\lambda_{e5} - \lambda_{e3})} - \frac{d_{12} \lambda_{r2} L_{231} L_{121} C_{m1}(0)}{(\lambda_{e6} - \lambda_{e3})(\lambda_{e5} - \lambda_{e3})(\lambda_{e3} - \lambda_{e1})} \right] e^{-\lambda_{e3}t} \\
& + \left[\frac{L_{232} C_{m4}(0)}{\lambda_{e6} - \lambda_{e4}} + \frac{L_{232} L_{122} d_{12} \lambda_{r2} C_{m1}(0)}{(\lambda_{e6} - \lambda_{e4})(\lambda_{e4} - \lambda_{e1})(\lambda_{e4} - \lambda_{e2})} - \frac{L_{232} L_{122} C_{m2}(0)}{(\lambda_{e6} - \lambda_{e4})(\lambda_{e4} - \lambda_{e2})} \right. \\
& + \left. \frac{L_{232} d_{12} \lambda_{r2} L_{121} C_{m1}(0)}{(\lambda_{e6} - \lambda_{e4})(\lambda_{e4} - \lambda_{e1})(\lambda_{e4} - \lambda_{e3})} - \frac{L_{232} d_{12} \lambda_{r2} C_{m3}(0)}{(\lambda_{e6} - \lambda_{e4})(\lambda_{e4} - \lambda_{e3})} \right] e^{-\lambda_{e4}t}
\end{aligned} \tag{B.161}$$

$$\begin{aligned}
 & + \left[\frac{d_{12} \lambda_{r2} C_{m5}(0)}{\lambda_{e6} - \lambda_{e5}} - \frac{d_{12} \lambda_{r2} L_{231} C_{m3}(0)}{(\lambda_{e6} - \lambda_{e5})(\lambda_{e5} - \lambda_{e3})} + \frac{d_{12} \lambda_{r2} L_{231} L_{121} C_{m1}(0)}{(\lambda_{e6} - \lambda_{e5})(\lambda_{e5} - \lambda_{e1})(\lambda_{e5} - \lambda_{e3})} \right] e^{-\lambda_{e5}t} \\
 & + \left[C_{m6}(0) - \frac{L_{232} C_{m4}(0)}{\lambda_{e6} - \lambda_{e4}} - \frac{d_{12} \lambda_{r2} C_{m5}(0)}{\lambda_{e6} - \lambda_{e5}} + \frac{L_{232} L_{122} C_{m2}(0)}{(\lambda_{e6} - \lambda_{e2})(\lambda_{e6} - \lambda_{e4})} + \frac{L_{232} d_{12} \lambda_{r2} C_{m3}(0)}{(\lambda_{e6} - \lambda_{e3})(\lambda_{e6} - \lambda_{e4})} \right. \\
 & + \frac{d_{12} \lambda_{r2} L_{231} C_{m3}(0)}{(\lambda_{e6} - \lambda_{e3})(\lambda_{e6} - \lambda_{e5})} - \frac{L_{232} L_{122} d_{12} \lambda_{r2} C_{m1}(0)}{(\lambda_{e6} - \lambda_{e1})(\lambda_{e6} - \lambda_{e2})(\lambda_{e6} - \lambda_{e4})} \\
 & \left. - \frac{L_{232} d_{12} \lambda_{r2} L_{121} C_{m1}(0)}{(\lambda_{e6} - \lambda_{e1})(\lambda_{e6} - \lambda_{e3})(\lambda_{e6} - \lambda_{e4})} - \frac{d_{12} \lambda_{r2} L_{231} L_{121} C_{m1}(0)}{(\lambda_{e6} - \lambda_{e1})(\lambda_{e6} - \lambda_{e3})(\lambda_{e6} - \lambda_{e5})} \right] e^{-\lambda_{e6}t}
 \end{aligned}$$

As mentioned above, the operator equations have a limitation caused by the form of the denominator to Equation (B.17): $\lambda_{ej} - \lambda_{en}$. Because the difference between the two rate constants appears in the denominator, the rate constants must be unequal. This condition is met for all radionuclide chains (unequal half-lives) and all transfers between boxes (unequal rate constants for transfer out of boxes 1 and 2 for the drinking water scenario).

The activity in each box after a time period for the water-use model of the drinking water scenario is represented as follows:

$$A_{dk} \{C_*, t_*\} \tag{B.162}$$

where $A_{dk}\{\}$ represents the operator for the activity after a time period in the drinking water water-use model with results given for box k, C_* is the array of initial activities or concentrations of all radionuclides in all boxes of the water-use model (in pCi/medium), and t is a time period of interest. The units of $A_{dk}\{\}$ are the same as the units of C_* . Note that the results of the operator are defined for one box at a time by subscript k (replaceable by 1, 2, or 3). The particular radionuclide of interest is represented by the subscript given on the activity or concentration array, C_* . For example, the results for radionuclide j in box 3 (aquifer) after a time t_j are represented as

$$A_{d3} \{C_{kj}, t_j\} \tag{B.163}$$

Here, the input activity array includes activities of all radionuclides through radionuclide j of the decay chain in all boxes k of the water-use model. The time-integral operator for the drinking water water-use model is represented similarly:

$$S_{dk} \{C_*, t_*\} \tag{B.164}$$

where $S_{dk}\{\}$ represents the operation of time integration over a time period, t_* , in the water-use model with results given for box k, and other terms are as previously defined. The deposition, accumulation, and time-integration

operations, $R\{\}$ and $G\{\}$, are not needed for the water-use model because none of the evaluations needed to implement the water-use model involves deposition.

The operator notation can be related to the equations defined in this section for the activity of each radionuclide present in each box of the drinking water scenario water-use model. The sample case used to illustrate generation of the equations involved a two-membered decay chain. Therefore, each box of the water-use model will have two numerical values generated from application of the decay operator. For example, the notation for the first box given above, $A_{d1}\{C_{kj}, t_y\}$, represents two numerical values: one for the parent and one for the progeny radionuclide. There will also be a total of six numerical values associated with the total solution: two values for each of the three boxes. These are related to previous equations as follows:

<u>Chain Member</u>	<u>Water-use Model Box</u>	<u>Reference Equation</u>	<u>Expression</u>
1	1	B.113	$A_{d1}\{\} = C_{m1}(t_y)$
2	1	B.120	$A_{d1}\{\} = C_{m2}(t_y)$
1	2	B.129	$A_{d2}\{\} = C_{m3}(t_y)$
2	2	B.143	$A_{d2}\{\} = C_{m4}(t_y)$
1	3	B.157	$A_{d3}\{\} = C_{m5}(t_y)$
2	3	B.161	$A_{d3}\{\} = C_{m6}(t_y)$

B.6.2 Solution to Water-Use Model for the Drinking Water Scenario

This section presents the derivation of the solution to the drinking water scenario water-use model differential equations. The solution is also compared to the decay operator equations (defined in Section B.1) as illustrated for a sample case in Section B.6.1. The differential equations for the water-use model are as follows (repeated from Section 4.1.3):

for box 1 (surface-soil layer),

$$\frac{dC_{1j}}{dt} = \sum_{n=1}^{j-1} d_{nj} \lambda_{rj} C_{1n} - (\lambda_{rj} + L_{12j}) C_{1j} \quad (\text{B.165})$$

for box 2 (unsaturated-soil layer),

$$\frac{dC_{2j}}{dt} = \sum_{n=1}^{j-1} d_{nj} \lambda_{rj} C_{2n} + L_{12j} C_{1j} - (\lambda_{rj} + L_{23j}) C_{2j} \quad (\text{B.166})$$

and for box 3 (aquifer),

Appendix B

$$\frac{dC_{3j}}{dt} = \sum_{n=1}^{j-1} d_{nj} \lambda_{rj} C_{3n} + L_{23j} C_{2j} - (\lambda_{rj} + w_d) C_{3j} \quad (\text{B.167})$$

where C_{1j} = activity of radionuclide j in box 1 at time t (pCi)

C_{2j} = activity of radionuclide j in box 2 at time t (pCi)

C_{3j} = activity of radionuclide j in box 3 at time t (pCi)

C_{1n} = activity of radionuclide n as a precursor to radionuclide j in box 1 at time t (pCi)

C_{2n} = activity of radionuclide n as a precursor to radionuclide j in box 2 at time t (pCi)

C_{3n} = activity of radionuclide n as a precursor to radionuclide j in box 3 at time t (pCi)

j = index of current chain member position in decay chain

n = index of precursor chain members in decay chain ($n < j$)

L_{12j} = rate constant for movement of radionuclide j from box 1 to box 2 (d^{-1})

L_{23j} = rate constant for movement of radionuclide j from box 2 to box 3 (d^{-1})

w_d = rate constant for pumping of water from the aquifer (d^{-1})

d_{nj} = fraction of radionuclide n transitions that result in production of radionuclide j

λ_{rj} = decay rate constant for radioactive decay of radionuclide j (d^{-1}).

The solution to these differential equations will be demonstrated for the parent and first progeny radionuclides in box 1, and for the parent radionuclides in boxes 2 and 3. The differential equation for the parent radionuclide in box 1 can be written as follows from Equation (B.165):

$$\frac{dC_{11}}{dt} = - (\lambda_{r1} + L_{121}) C_{11} \quad (\text{B.168})$$

Combining terms containing C_{11} , and multiplying by the integration factor $e^{(\lambda_{r1} + L_{121})t}$, gives the following equation:

$$(dC_{11}) e^{(\lambda_{r1} + L_{121})t} + (\lambda_{r1} + L_{121}) C_{11} e^{(\lambda_{r1} + L_{121})t} dt = 0 \quad (\text{B.169})$$

This can be written as a differential as follows:

$$\frac{d \left[C_{11} e^{(\lambda_{r1} + L_{121})t} \right]}{dt} = 0 \quad (\text{B.170})$$

The integral form can be written as follows:

$$C_{11} e^{(\lambda_{r1} + L_{121})t} = \text{Constant} \quad (\text{B.171})$$

and

$$C_{11} = \text{Constant} e^{-(\lambda_{r1} + L_{121})t} \quad (\text{B.172})$$

Using the initial condition of $C_{11} = C_{11}(0)$ at $t=0$, the constant is evaluated as equal to $C_{11}(0)$. Then, the activity of parent radionuclide in box 1 as a function of time is expressed as follows:

$$C_{11}(t) = C_{11}(0) e^{-(\lambda_{r1} + L_{121})t} \quad (\text{B.173})$$

(Note: this equation is equivalent to Equation [B.113] with $\lambda_{r1} + L_{121} = \lambda_{e1}$ and $C_{11} = C_{m1}$.)

The differential equation for the first progeny in box 1 is as follows:

$$\frac{dC_{12}}{dt} = d_{12} \lambda_{r2} C_{11} - (\lambda_{r2} + L_{122}) C_{12} \quad (\text{B.174})$$

Arranging terms containing C_{12} on the left side of the equation, substituting the expression for C_{11} from Equation (B.173), and multiplying by the integrating factor $e^{(\lambda_{r2} + L_{122})t}$ results in the following expression:

$$\frac{d \left[C_{12} e^{(\lambda_{r2} + L_{122})t} \right]}{dt} = d_{12} \lambda_{r2} C_{11}(0) e^{[(\lambda_{r2} + L_{122}) - (\lambda_{r1} + L_{121})]t} \quad (\text{B.175})$$

The integral expression is as follows:

$$C_{12}(t) = \frac{d_{12} \lambda_{r2} C_{11}(0) e^{-(\lambda_{r1} + L_{121})t}}{(\lambda_{r2} + L_{122}) - (\lambda_{r1} + L_{121})} + \text{Constant} e^{-(\lambda_{r2} + L_{122})t} \quad (\text{B.176})$$

Using the condition that $C_{12} = C_{12}(0)$ at $t = 0$, the constant is evaluated as follows:

Appendix B

$$\text{Constant} = C_{12}(0) - \frac{d_{12}\lambda_{r2} C_{11}(0)}{(\lambda_{r2} + L_{122}) - (\lambda_{r1} + L_{121})} \quad (\text{B.177})$$

The final expression for the amount of the first progeny radionuclide in box 1 is then

$$C_{12}(t) = \frac{d_{12}\lambda_{r2} C_{11}(0) e^{-(\lambda_{r1} + L_{121})t}}{(\lambda_{r2} + L_{122}) - (\lambda_{r1} + L_{121})} + \left[C_{12}(0) - \frac{d_{12}\lambda_{r2} C_{11}(0)}{(\lambda_{r2} + L_{122}) - (\lambda_{r1} + L_{121})} \right] e^{-(\lambda_{r2} + L_{122})t} \quad (\text{B.178})$$

(Note: This expression is equivalent to Equation [B.120] with $C_{12} = C_{m2}$, and $\lambda_{r2} + L_{122} = \lambda_{e2}$.)

The differential equation for the activity of parent radionuclide in box 2 is written as follows from Equation (B.166):

$$\frac{dC_{21}}{dt} = L_{121} C_{11} - (\lambda_{r1} + L_{231})C_{21} \quad (\text{B.179})$$

Arranging terms containing C_{21} on the left side of the equation, substituting the expression for C_{11} from Equation (B.173), and multiplying by the integrating factor $e^{(\lambda_{r1} + L_{231})t}$ results in the following expression:

$$\frac{dC_{21} e^{(\lambda_{r1} + L_{231})t}}{dt} = L_{121} C_{11}(0) e^{[(\lambda_{r1} + L_{231}) - (\lambda_{r1} + L_{121})]t} \quad (\text{B.180})$$

The integral expression is as follows:

$$C_{21} = \frac{L_{121} C_{11}(0) e^{-(\lambda_{r1} + L_{121})t}}{(\lambda_{r1} + L_{231}) - (\lambda_{r1} + L_{121})} + \text{Constant} e^{-(\lambda_{r1} + L_{231})t} \quad (\text{B.181})$$

Using the condition that $C_{21} = C_{21}(0)$ at $t=0$, the constant is evaluated as follows:

$$\text{Constant} = C_{21}(0) - \frac{L_{121} C_{11}(0)}{(\lambda_{r1} + L_{231}) - (\lambda_{r1} + L_{121})} \quad (\text{B.182})$$

The final expression for the amount of parent radionuclide in box 2 is then

$$C_{21}(t) = \frac{L_{121} C_{11}(0) e^{-(\lambda_{r1} + L_{121})t}}{(\lambda_{r1} + L_{231}) - (\lambda_{r1} + L_{121})} + \left[C_{21}(0) - \frac{L_{121} C_{11}(0)}{(\lambda_{r1} + L_{231}) - (\lambda_{r1} + L_{121})} \right] e^{-(\lambda_{r1} + L_{231})t} \quad (\text{B.183})$$

(Note: This expression is equivalent to Equation [B.129] with $C_{21} = C_{m3}$ and $\lambda_{r1} + L_{231} = \lambda_{e3}$ and previous substitutions as indicated for Equations [B.173] and [B.178].)

The differential equation for the amount of the parent radionuclide in box 3 is written as follows from Equation (B.167):

$$\frac{dC_{31}}{dt} - L_{231} Q_{21} - (\lambda_{r1} + w_d) Q_{31} \quad (\text{B.184})$$

Arranging terms containing C_{31} on the left side of the equation, substituting the expression for C_{21} from Equation (B.183), and multiplying by the integration factor $e^{(\lambda_{r1} + w_d)t}$ results in the following expression:

$$\begin{aligned} \frac{d[C_{31} e^{(\lambda_{r1} + w_d)t}]}{dt} - \frac{L_{231} L_{121} C_{11}(0) e^{[(\lambda_{r1} + w_d) - (\lambda_{r1} + L_{121})]t}}{(\lambda_{r1} + L_{231}) - (\lambda_{r1} + L_{121})} \\ + L_{231} C_{21}(0) e^{[(\lambda_{r1} + w_d) - (\lambda_{r1} + L_{231})]t} \\ - \frac{L_{231} L_{121} C_{11}(0) e^{[(\lambda_{r1} + w_d) - (\lambda_{r1} + L_{231})]t}}{(\lambda_{r1} + L_{231}) - (\lambda_{r1} + L_{121})} \end{aligned} \quad (\text{B.185})$$

As before, the integral of this expression can be written as follows:

Appendix B

$$\begin{aligned}
 C_{31}(t) = & \frac{L_{231} L_{121} C_{11}(0) e^{-(\lambda_{r1} + L_{121})t}}{\left[(\lambda_{r1} + L_{231}) - (\lambda_{r1} + L_{121}) \right] \left[(\lambda_{r1} + w_d) - (\lambda_{r1} + L_{121}) \right]} \\
 & + \frac{L_{231} C_{21}(0) e^{-(\lambda_{r1} + L_{231})t}}{(\lambda_{r1} + w_d) - (\lambda_{r1} + L_{231})} \\
 & - \frac{L_{231} L_{121} C_{11}(0) e^{-(\lambda_{r1} + L_{231})t}}{\left[(\lambda_{r1} + L_{231}) - (\lambda_{r1} + L_{121}) \right] \left[(\lambda_{r1} + w_d) - (\lambda_{r1} + L_{231}) \right]} + \text{Constant } e^{-(\lambda_{r1} + w_d)t}
 \end{aligned} \tag{B.186}$$

The constant can be evaluated from the condition that $C_{31} = C_{31}(0)$ at $t=0$, as follows:

$$\begin{aligned}
 \text{Constant} = C_{31}(0) - & \frac{L_{231} C_{21}(0)}{(\lambda_{r1} + w_d) - (\lambda_{r1} + L_{231})} \\
 & - \frac{L_{231} L_{121} C_{11}(0)}{\left[(\lambda_{r1} + L_{231}) - (\lambda_{r1} + L_{121}) \right] \left[(\lambda_{r1} + w_d) - (\lambda_{r1} + L_{121}) \right]} \\
 & + \frac{L_{231} L_{121} C_{11}(0)}{\left[(\lambda_{r1} + L_{231}) - (\lambda_{r1} + L_{121}) \right] \left[(\lambda_{r1} + w_d) - (\lambda_{r1} + L_{231}) \right]}
 \end{aligned} \tag{B.187}$$

This expression can be reduced using the algebraic identity defined in Equation (B.51) with $a = \lambda_{r1} + L_{121}$, $b = \lambda_{r1} + L_{231}$, and $c = \lambda_{r1} + w_d$. The expression for the constant becomes

$$\begin{aligned}
 \text{Constant} = C_{31}(0) - & \frac{L_{231} C_{21}(0)}{(\lambda_{r1} + w_d) - (\lambda_{r1} + L_{231})} \\
 & + \frac{L_{231} L_{121} C_{11}(0)}{\left[(\lambda_{r1} + w_d) - (\lambda_{r1} + L_{121}) \right] \left[(\lambda_{r1} + w_d) - (\lambda_{r1} + L_{231}) \right]}
 \end{aligned} \tag{B.188}$$

Substituting this expression into Equation (B.186) results in the following equation for the amount of parent radionuclide in box 3 as a function of time:

$$\begin{aligned}
C_{31}(t) = & \frac{L_{231} L_{121} C_{11}(0) e^{-(\lambda_{r1} + L_{121})t}}{[(\lambda_{r1} + L_{231}) - (\lambda_{r1} + L_{121})][(\lambda_{r1} + w_d) - (\lambda_{r1} + L_{121})]} + \left\{ \frac{L_{231} C_{21}(0)}{(\lambda_{r1} + w_d) - (\lambda_{r1} + L_{231})} \right. \\
& - \left. \frac{L_{231} L_{121} C_{11}(0)}{[(\lambda_{r1} + L_{231}) - (\lambda_{r1} + L_{121})][(\lambda_{r1} + w_d) - (\lambda_{r1} + L_{231})]} \right\} e^{-(\lambda_{r1} + L_{231})t} \\
& + \left\{ C_{31}(0) - \frac{L_{231} C_{21}(0)}{(\lambda_{r1} + w_d) - (\lambda_{r1} + L_{231})} \right. \\
& \left. + \frac{L_{231} L_{121} C_{11}(0)}{[(\lambda_{r1} + w_d) - (\lambda_{r1} + L_{121})][(\lambda_{r1} + w_d) - (\lambda_{r1} + L_{231})]} \right\} e^{-(\lambda_{r1} + w_d)t}
\end{aligned} \tag{B.189}$$

(Note: This equation is equivalent to Equation [B.157] with $C_{31} = C_{m5}$ and $\lambda_{r1} + w_d = \lambda_{e5}$ and previous substitutions as indicated for Equations [B.173], [B.178], and [B.183].)

B.7 Water-Use Model for the Residential Scenario

The water-use model for the residential scenario, as described in Section 5.6.6, is very similar to the water-use model for the drinking water scenario, with one major exception. The residential scenario involves recycling of activity from the aquifer (box 3) to the surface-soil layer (box 1). This recycling pathway causes a number of complications in the equations for calculating the activity in each box as a function of time. The decay operator equations can not be applied directly to solve the problem, as was possible for the simpler drinking water scenario water-use model. General methods for solving the recycling case have been published based on matrix algebra with the aid of computers in generating numerical solutions to specific cases. A method for solving the three-box water-use model with recycling is provided in the discussion that follows.

The three-box ground-water model for a parent and a single radioactive progeny can be solved numerically using the method of Birchall and James (1989). To apply this method, consider the representation of the three-box model presented in Figure B.1. This figure illustrates the three-box model for the residential scenario with recycling from box 3 to box 1 for a two-membered decay chain. Application of the Birchall and James method requires defining the matrices to represent the system. Table B.1 illustrates the methods for establishing the system matrix [R]. The [R] matrix is given by the portion of the table within the double lines. The column labeled "Out" contains additional removal rate terms that do not appear as input to any of the Q_{ij} compartments; these terms appear below as "further reductions" in the [A] matrix (Birchall and James 1989). Note that quantities are represented in units of atoms for this application. Conversion between atom units and activity units is performed on the result according to Equation (B.26).

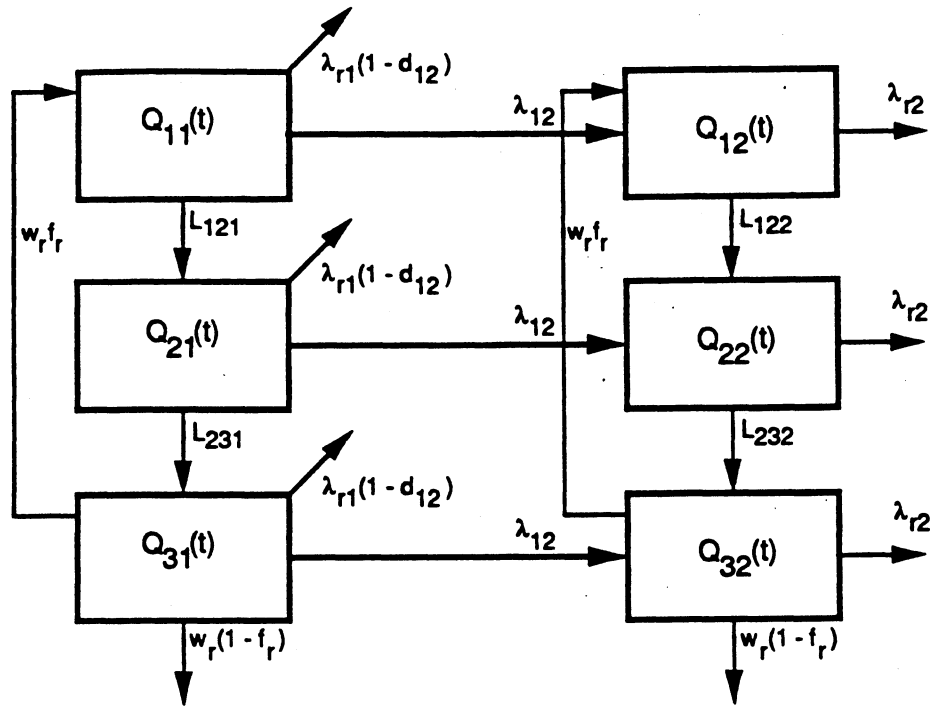

Figure B.1 Residential scenario three-box water-use model

Table B.1 System matrix generation table

	To:						
matrix [R]	Q ₁₁ (t)	Q ₂₁ (t)	Q ₃₁ (t)	Q ₁₂ (t)	Q ₂₂ (t)	Q ₃₂ (t)	Out
From: Q ₁₁ (t)	Q ₁₁ (0)	L ₁₂₁		λ ₁₂			λ _{r1} (1-d ₁₂)
Q ₂₁ (t)		Q ₂₁ (0)	L ₂₃₁		λ ₁₂		λ _{r1} (1-d ₁₂)
Q ₃₁ (t)	f _r w _r		Q ₃₁ (0)			λ ₁₂	λ _{r1} (1-d ₁₂) + w _r (1-f _r)
Q ₁₂ (t)				Q ₁₂ (0)	L ₁₂₂		λ _{r2}
Q ₂₂ (t)					Q ₂₂ (0)	L ₂₃₂	λ _{r2}
Q ₃₂ (t)				f _r w _r		Q ₃₂ (0)	λ _{r2} + w _r (1-f _r)

From the matrix [R] is formed the matrix [A] with reductions along the diagonal as shown above. Note that many of the terms along the diagonal simplify, since $\lambda_{r1} = \lambda_{12} + \lambda_{r1}(1-d_{12})$ and $w_r = w_{rT} + w_r(1-f_r)$. The first expression is a result of the definition of the fractional decay rate constant, λ_{12} , which is equal to the product of the branching fraction, d_{12} , and the radioactive decay rate constant, λ_{r1} .

$$[A] = \begin{bmatrix} -L_{121} - \lambda_{r1} & 0 & f_r w_r & 0 & 0 & 0 \\ L_{121} & -L_{231} - \lambda_{r1} & 0 & 0 & 0 & 0 \\ 0 & L_{231} & -w_r - \lambda_{r1} & 0 & 0 & 0 \\ \lambda_{12} & 0 & 0 & -L_{122} - \lambda_{r2} & 0 & 0 \\ 0 & \lambda_{12} & 0 & L_{122} & -L_{232} - \lambda_{r2} & 0 \\ 0 & 0 & \lambda_{12} & 0 & L_{232} & -w_r - \lambda_{r2} \end{bmatrix} \quad (\text{B.190})$$

Multiplying each element in matrix [A] by the scalar t gives:

$$[A]t = \begin{bmatrix} -(L_{121} + \lambda_{r1})t & 0 & f_r w_r t & 0 & 0 & 0 \\ L_{121}t & -(L_{231} + \lambda_{r1})t & 0 & 0 & 0 & 0 \\ 0 & L_{231}t & -(w_r + \lambda_{r1})t & 0 & 0 & 0 \\ \lambda_{12}t & 0 & 0 & -(L_{122} + \lambda_{r2})t & 0 & f_r w_r t \\ 0 & \lambda_{12}t & 0 & L_{122}t & -(L_{232} + \lambda_{r2})t & 0 \\ 0 & 0 & \lambda_{12}t & 0 & L_{232}t & -(w_r + \lambda_{r2})t \end{bmatrix} \quad (\text{B.191})$$

Let Φ denote the eigenvalues of [A]t, $[\epsilon_1, \epsilon_2, \epsilon_3, \epsilon_4, \epsilon_5, \epsilon_6]$. Form a matrix $[\Phi]$ whose diagonal is the exponential of each eigenvalue:

$$[\Phi] = \begin{bmatrix} e^{\epsilon_1} & 0 & 0 & 0 & 0 & 0 \\ 0 & e^{\epsilon_2} & 0 & 0 & 0 & 0 \\ 0 & 0 & e^{\epsilon_3} & 0 & 0 & 0 \\ 0 & 0 & 0 & e^{\epsilon_4} & 0 & 0 \\ 0 & 0 & 0 & 0 & e^{\epsilon_5} & 0 \\ 0 & 0 & 0 & 0 & 0 & e^{\epsilon_6} \end{bmatrix} \quad (\text{B.192})$$

Let $[\Psi]$ denote the matrix of eigenvectors of [A]t, and $[\Psi]^{-1}$ denote its inverse. The general solution to the three-box model becomes

$$\begin{bmatrix} Q_{11}(t) \\ Q_{21}(t) \\ Q_{31}(t) \\ Q_{12}(t) \\ Q_{22}(t) \\ Q_{32}(t) \end{bmatrix} = [\Psi] [\Phi] [\Psi]^{-1} \begin{bmatrix} Q_{11}(0) \\ Q_{21}(0) \\ Q_{31}(0) \\ Q_{12}(0) \\ Q_{22}(0) \\ Q_{32}(0) \end{bmatrix} \quad (\text{B.193})$$

While there are many commercially available programs that can solve the above equation if it contains completely numeric values and coefficients (including time), solving it symbolically requires the solution of a characteristic equation that is at least of sixth order, which cannot be done analytically.

The solution matrix expressed by Equation (B.190) is represented by the three-box operator, $A_{rk}\{C_{k},t\}$, when multiplied by the radioactive decay constant for the radionuclide of interest. For example, the activity of the third chain member in the first box (surface soil) after a time period, t , is given as follows:

$$A_{r1}\{C_{k3},t\} = \lambda_{r3} \cdot Q_{13}(t) \quad (\text{B.194})$$

where $A_{r1}\{\}$ = activity of radionuclide chain member 3 in box 1 after a time period t following definition of the initial inventory (pCi/g)

C_{k3} = array of initial activities of all chain members through chain member 3 in all boxes of the water-use model (pCi/g)

λ_{r3} = radioactive decay rate constant for radionuclide chain member 3 (d^{-1}).

The time-integral operator for the residential scenario, $S_{rk}\{\}$, can be represented similarly using the numerical solution to the time integral for each radionuclide activity in the appropriate box. For example, the activity of the third chain member in the first box after a time period, t_y , is given as follows:

$$S_{r1}\{C_{k3},t_y\} = \lambda_{r3} \int_0^{t_y} Q_{13}(t) dt \quad (\text{B.195})$$

where $S_{r1}\{\}$ = time integral of activity of radionuclide chain member 3 in box 1 after a time period, t_y , following definition of the initial inventory (pCi·d/g)

and other terms are as previously defined.

B.8 References

Bateman, H. 1910. "Solution of a System of Differential Equations Occurring in the Theory of Radio-Active Transformation." *Proc. Cambridge Phil. Soc.* 15:423-427.

Birchall, A., and A. C. James. 1989. "A Microcomputer Algorithm for Solving First Order Compartmental Models Involving Recycling." *Health Phy.* 56(6):857-868.

Friedlander, G., and J. W. Kennedy. 1955. *Nuclear and Radiochemistry*. John Wiley & Sons, New York.

Hamawi, J. M. 1971. "A Useful Recurrence Formula for the Equations of Radioactive Decay." *Nucl. Tech.* 11:84-88.

Houston, J. R., D. L. Streng, and E. C. Watson. 1976. *DACRIN - A Computer Program for Calculating Organ Dose from Acute or Chronic Radionuclide Inhalation*. USAEC Report, BNWL-B-454, Pacific Northwest Laboratory, Richland, Washington.

Napier, B. A., R. A. Peloquin, and D. L. Streng. 1986. *DITTY - A Computer Program for Calculating Population Dose Integrated Over Ten Thousand Years*. PNL-4456, Pacific Northwest Laboratory, Richland, Washington.

Napier, B. A., R. A. Peloquin, and D. L. Streng, and J. V. Ramsdell. 1988. *Hanford Environmental Dosimetry Upgrade Project, GENII - the Hanford Environmental Radiation Dosimetry Software Package*. PNL-6584, Vol. 1-3, Pacific Northwest Laboratory, Richland, Washington.

Scherpelz, R. I., and A. E. Desrosiers. 1980. "A Modification to a Recurrence Formula for Linear First-Order Equations." *Health Physics* 40:905-907.

Skrable, K., C. French., G. Chabot, and A. Major. 1974. "A General Equation for the Kinetics of Linear First Order Phenomena and Suggested Applications." *Health Physics*. 27:155-57.

Streng, D. L., M. M. Hendrickson, and E. C. Watson. 1971. *RACER - A Computer Program for Calculating External Dose from Airborne Fission Products Following Postulated Reactor Accidents*. USAEC Report, BNWL-B-69, Pacific Northwest Laboratory, Richland, Washington.

Streng, D. L., R. A. Peloquin, M. J. Sula, and J. R. Johnson. 1990. *Code for Internal Dosimetry (CINDY). Part 1: Conceptual Representation. Part 2: User's Guide*. PNL-7493, Pacific Northwest Laboratory, Richland, Washington.

Streng, D. L., and E. C. Watson. 1973. *KRONIC - A Computer Program for Calculating Annual Average External Doses from Chronic Atmospheric Releases of Radionuclides*. USAEC Report, BNWL-B-264, Pacific Northwest Laboratory, Richland, Washington.

Streng, D. L., E. C. Watson, and J. R. Houston. 1975. *SUBDOSIA - A Computer Program for Calculating Individual External Doses from Accidental Atmospheric Releases of Radionuclides*. USAEC Report, BNWL-B-351, Pacific Northwest Laboratory, Richland, Washington.

Appendix C

Carbon-14 Agricultural Pathway Model

Appendix C

Carbon-14 Agricultural Pathway Model

Because of its production in the nuclear fuel cycle, its long half-life, and its environmental mobility, carbon-14 has attracted significant research and modeling interest. Examples of these efforts include studies by the Nuclear Energy Agency (1980), Wirth (1982), Till and Meyer (1983), Napier et al. (1988), Sheppard, Sheppard, and Amiro (1991), and Amiro, Zhuang, and Sheppard (1991). For this study, the transfer of carbon-14 from air, soil, and water to plants is evaluated using the models for other radionuclides as described in the previous sections. The transfer from animal feed to animal products is evaluated using the specific activity models and special parameters described in this appendix.

C.1 Transfer of Carbon-14 from Soil to Plants

The transfer of carbon-14 from soil to plants is based on the concentration factor (B_{iv}) approach. The value selected for the concentration factor is critical in defining the level of conservatism in the evaluations. Recent experimental work by Sheppard, Sheppard, and Amiro (1991) has addressed the estimation of the concentration factor for edible plants (radishes and beans). For application of carbon in the form of NaHCO_3 to two soil types (undisturbed soils with high-organic-matter content and acidic low-organic-matter content), they derived experimental B_{iv} values of 0.7 and 1.3, on a dry weight basis for the two soils, respectively. Their experiments also suggested that most of the transfer from soil to plant was via air, rather than via root uptake. Similar experiments using labeled 2,2',5,5' tetrachlorobiphenyl (^{14}C -PCB) resulted in B_{iv} estimates of 0.014 and 0.088 for the two soils, respectively. A reasonably conservative estimate for the B_{iv} value for the residential scenario is taken to be 0.7, representing uptake in organic soils that are likely to be used for gardening.

C.2 Transfer of Carbon-14 to Animal Products

The model for carbon-14 concentration in animal products is based on the assumption that the specific activity of carbon-14 in the animal product is equal to the specific activity of carbon-14 in the animal intake as follows:

$$\text{pCi carbon-14/kg carbon in animal product} = \text{pCi carbon-14/kg carbon total intake} \quad (\text{C.1})$$

where the total animal intake results from the consumption of contaminated fresh forage, stored feed, soil, and water.

The partial pathway transfer factor (PPTF) for carbon-14 in animal products is estimated for soil sources as in Equation (C.2). The decay correction for holdup between harvesting of the animal product and its consumption by humans is not needed because of the long half-life of carbon-14. The time integral of activity over the intake period is represented as concentration times intake time. The equation for the soil pathway includes the ingestion of soil by grazing animals.

Appendix C

$$PPTF_{asC} = f_{Ca} \left[Q_f x_f C_{sfCc} t_{ff} + Q_d W_f Q_f x_f C_{soil} t_{ff} + Q_g x_g C_{sgCc} t_{fg} + Q_h x_h C_{shCc} t_{fh} \right] \quad (C.2)$$

$$t_{ca} SA_{TaC} / \left[\left(f_{Cf} Q_f t_{ff} + f_{Cd} Q_d W_f Q_f t_{ff} + f_{Cg} Q_g t_{fg} + f_{Ch} Q_h t_{fh} \right) 365.25 \right]$$

where $PPTF_{asC}$ = partial pathway transfer factor for animal product type a, for carbon-14, for unit initial concentration of carbon-14 in soil (pCi·y/kg wet-weight per pCi/g)

f_{Ca} = fraction of carbon in animal product a (kg carbon/kg wet-weight animal product)

f_{Cf} = fraction of carbon in animal fresh forage f (kg carbon/kg wet-weight ~~animal product~~ ^{forage})

f_{Cg} = fraction of carbon in animal stored grain g (kg carbon/kg wet-weight ~~animal product~~ ^{stored grain})

f_{Ch} = fraction of carbon in animal stored hay h (kg carbon/kg wet-weight ~~animal product~~ ^{stored hay})

f_{Cd} = fraction of carbon in soil (kg carbon/kg dry-weight soil)

Q_d = soil dry-weight consumption rate as a fraction of the fresh forage consumption rate by the animal (kg dry-weight soil/kg dry-weight forage)

Q_f = consumption rate of fresh forage by the animal (kg wet-weight forage/d)

Q_g = consumption rate of stored grain by the animal (kg wet-weight grain/d)

Q_h = consumption rate of stored hay by the animal (kg wet-weight hay/d)

C_{sfCc} = concentration factor for carbon-14 in fresh forage plant f at time of harvest, from unit initial concentration of carbon-14 in soil (pCi/kg wet-weight forage per pCi/g dry-weight soil)

C_{sgCc} = concentration factor for carbon-14 in stored grain plant g at time of harvest, from unit initial concentration of carbon-14 in soil (pCi/kg wet-weight grain per pCi/g dry-weight soil)

C_{shCc} = concentration factor for carbon-14 in stored hay plant h at time of harvest, from unit initial concentration of carbon-14 in soil (pCi/kg wet-weight hay per pCi/g dry-weight soil)

C_{soil} = ratio of the carbon-14 concentration in soil eaten by the animal to the initial concentration of carbon-14 in the soil, with units conversion from grams to kilograms (pCi/kg dry-weight soil per pCi/g dry-weight soil)

t_{ff} = time period over which the animal is fed fresh forage (d)

t_{fg} = time period over which the animal is fed stored grain (d)

t_{fh} = time period over which the animal is fed stored hay (d)

t_{ca} = time period over which the animal product is consumed by humans (d for a year of residential scenario)

W_f = factor for conversion of mass of forage crop from a dry-weight to a wet-weight basis (kg dry weight per kg wet weight)

SA_{TaC} = specific activity equivalence of animal product type a and the specific activity of the total fresh forage and stored feed intake (pCi carbon-14/kg carbon in animal product per pCi carbon-14/kg carbon in fresh forage, stored feed, and ingested soil)

x_f = fraction of animal is intake of forage that is contaminated (dimensionless)

x_g = fraction of animal is intake of stored grain that is contaminated (dimensionless)

x_h = fraction of animal is intake of stored hay that is contaminated (dimensionless)

365.25 = unit conversion factor (d/y).

The soil concentration term, C_{soil} , is numerically equal to the conversion factor 1000 g/kg because both soil concentrations (soil eaten and initial soil) are defined to be equal. Because carbon-14 is long-lived, the concentration in soil during the feeding period is equal to the initial carbon-14 concentration in soil.

The PPTF for animal products for carbon-14 in water is evaluated using Equation (C.2), with the subscript w replacing subscript s. Also, the animal is assumed to drink the contaminated irrigation water. All the carbon in the irrigation water is assumed to be carbon-14. Therefore, the specific activity equivalence term for animal products includes the carbon-14 intakes from fresh forage, stored feed, soil, and water and the carbon intakes of only the fresh forage, stored feed, and soil. The PPTF is evaluated as follows:

$$\begin{aligned} PPTF_{awC} = & \left[f_{Ca} \left(Q_f x_f C_{wfCc} t_{ff} + Q_d W_f Q_f x_f C_{wfCd} t_{ff} + Q_g x_g C_{wgCc} t_{fg} \right. \right. \\ & \left. \left. + Q_h x_h C_{whCc} t_{fh} + Q_w x_w C_{wwCc} t_{fw} \right) t_{ca} SA_{TaC} \right] / \\ & \left[\left(f_{Cf} Q_f t_{ff} + f_{Cd} Q_d W_f Q_f t_{ff} + f_{Cg} Q_g t_{fg} + f_{Ch} Q_h t_{fh} \right) 365.25 \right] \end{aligned} \quad (C.3)$$

where $PPTF_{awC}$ = partial pathway transfer factor for animal product type a, for carbon-14, for unit initial concentration of carbon-14 in water (pCi•y/kg per pCi/L for a year of residential scenario)

t_{fw} = period over which animal is fed contaminated water (d)

C_{wfCc} = concentration factor for carbon-14 in fresh forage plant f at time of animal consumption per unit initial concentration of carbon-14 in water (pCi/kg wet-weight forage per pCi/L)

C_{wfCd} = concentration factor for carbon-14 in soil at the time of animal consumption of soil per unit initial concentration of carbon-14 in water (pCi/kg dry-weight soil per pCi/L)

- C_{wgCc} = concentration factor for carbon-14 in stored grain plant g at time of animal consumption per unit initial concentration of carbon-14 in water (pCi/kg wet-weight grain per pCi/L)
- C_{whCc} = concentration factor for carbon-14 in stored hay plant h at time of animal consumption per unit initial concentration of carbon-14 in water (pCi/kg wet-weight hay per pCi/L water)
- C_{wwCc} = concentration factor for carbon-14 in water per unit initial concentration in water (added for clarity) (pCi/L per pCi/L)
- x_w = fraction of animal water intake that is contaminated (dimensionless)

and other terms are as previously defined.

C.3 Special Parameters for the Carbon-14 Model for Crops and Animal Products

The model for carbon-14 uses several special parameters for which values are provided in Table C.1.

Table C.1 Carbon model parameter values*

Parameter description	Value	
Fraction of animal product that is carbon:		
Beef	0.24	
Poultry	0.20	
Milk	0.07	
Eggs	0.15	
Fraction of animal feeds that is carbon:		
Beef	Forage	0.09
	Stored hay	0.09
	Stored grain	0.4
Poultry	Forage	0.09
	Stored hay	0.09
	Stored grain	0.4
Milk	Forage	0.09
	Stored hay	0.09
	Stored grain	0.4
Eggs	Forage	0.09
	Stored hay	0.09
	Stored grain	0.4
Fraction of soil that is carbon:	0.03	

*Values taken from Napier et al. (1988).

C.4 References

- Amiro, B. C., Y. Zhuang, and S. C. Sheppard. 1991. "Relative Importance of Atmospheric and Root Uptake Pathways for $^{14}\text{CO}_2$ Transfer from Contaminated Soil to Plants." *Health Physics* 61(6):825-829.
- Napier, B. A., R. A. Peloquin, D. L. Streng, and J. V. Ramsdell. 1988. *Hanford Environmental Dosimetry Upgrade Project, GENII - The Hanford Environmental Radiation Dosimetry Software Package*. PNL-6584, Vols. 1-3, Pacific Northwest Laboratory, Richland, Washington.
- Nuclear Energy Agency (NEA). 1980. *Radiological Significance and Management of Tritium, Carbon-14, Krypton-85, Iodine-129 Arising from the Nuclear Fuel Cycle*. Organization for Economic Co-Operation and Development, Paris, France.
- Sheppard, M. L., S. C. Sheppard, and B. D. Amiro. 1991. "Mobility and Plant Uptake of Inorganic ^{14}C and ^{14}C -Labelled PCB in Soils of High and Low Retention." *Health Physics* 61(4):481-492.
- Till, J. E., and H. R. Meyer, eds. 1983. *Radiological Assessment*. NUREG/CR-3332, ORNL-5968, U.S. Nuclear Regulatory Commission, Washington, D.C.
- Wirth, E. 1982. "The Applicability of the ^{14}C -Specific Activity Model." *Health Physics* 43(6):919-922.

Appendix D

Tritium Agricultural Pathway Model

Appendix D

Tritium Agricultural Pathway Model

Tritium is a radioactive form of hydrogen with a half-life of 12.43 years. It decays to helium-3 by emission of a low-energy beta particle. Tritium uptake by man can occur by exposure to air, water, or food. Numerous research studies have investigated the environmental and pathway modeling aspects of tritium, including those by Moghissi and Carter (1973), National Council on Radiation Protection and Measurements (1979), Murphy (1986 and 1990), Johnson et al. (1988), Killough and Kocher (1988), Diabate and Strack (1990), Neil (1990), and Straume (1991). For the scenarios used in this study, a special model is used to evaluate the transfer of tritium in food chains. The concentration of tritium in each food type is assumed to have the same specific activity as the contaminating medium. This assumption is approximately valid for situations involving continuous replenishment of tritium in the medium and represents a conservative approximation for residual radioactive material in soil.

D.1 Transfer of Tritium from Soil to Plants and Animal Products

When soil is contaminated with residual tritium and no tritium from air and water is continually added to the soil, the contamination would be expected to rapidly escape from the soil or plants that had taken up this tritium. This analysis, however, conservatively assumes that the soil tritium is retained and remains available for plant uptake over time. The transfer of tritium from soil to plants is evaluated using a specific activity model for root uptake. Resuspension of soil onto plants is not considered because the specific activity model predicts plant concentrations about two orders of magnitude greater than the resuspension contribution. Also, tritium is not normally bound tightly to soil and would be expected to escape rapidly from suspended particles.

The estimation of concentration in plants from root uptake of tritium in soil assumes equilibrium between tritium in soil moisture and the plant:

$$C_{svHh} = 9 f_{Hv} C_{sH} SA_{svH} 1000 / [S_H C_{sH}] \quad (D.1)$$

where C_{svHh} = concentration factor for tritium in food type v from unit initial concentration of tritium in soil (pCi/kg wet-weight plant per pCi/g dry-weight soil)

f_{Hv} = fraction of hydrogen in total vegetation (kg hydrogen in plant/kg wet-weight plant)

C_{sH} = initial concentration of tritium in soil (pCi/g)

SA_{svH} = specific activity equivalence of the soil and plant (pCi/kg hydrogen in plant per pCi/kg hydrogen in soil)

S_H = moisture content of soil (kg water/kg soil)

Appendix D

9 = conversion from soil water to soil hydrogen based on molecular components of water (kg water in soil/kg hydrogen in soil)

1000 = units conversion factor (g/kg).

Because the half-life of tritium is long compared to the time periods considered (1 year or less), it is not necessary to model the decay of tritium concentration in plants. The partial pathway transfer factor (PPTF) for tritium in soil is evaluated as the product of the time period times the average concentration:

$$PPTF_{vsH} = C_{svHh} t_{cv} / 365.25 \quad (D.2)$$

where $PPTF_{vsH}$ = partial pathway transfer factor for tritium in crop type v, per unit initial concentration of tritium in soil (pCi•y/kg wet-weight plant per pCi/g dry-weight soil for a year of residential scenario)

C_{svHh} = concentration factor for tritium in crop type v from root uptake at time of harvest for unit initial concentration of tritium in soil (pCi/kg wet-weight plant per pCi/g dry-weight soil)

t_{cv} = time period over which the crop is consumed (d for a year of residential scenario)

365.25 = unit conversion factor (d/y).

The model for tritium concentration in animal products from soil contamination is based on the assumption that the specific activity of the tritium in the animal product is equal to the specific activity of the total animal intake. For tritium, the total intake results from the consumption of contaminated fresh forage, stored feed, and soil. The total hydrogen intake considers the hydrogen contained in the fresh forage, stored feed, soil, and uncontaminated water. This is expressed as follows:

$$[\text{pCi tritium/kg hydrogen in animal product}] = [\text{pCi tritium intake in fresh forage, stored feed, and soil}] / [\text{kg hydrogen intake in fresh forage, stored feed, and water}] \quad (D.3)$$

The forage, stored grain, and stored hay tritium concentrations are evaluated by Equation (D.1) with subscripts v and h replaced by subscripts f (g or h) and c, respectively. The ingestion of soil by the animal during the grazing period is included.

The concentration of tritium in animal products is estimated for soil sources as follows. Again, decay is not considered because of the long half-life for tritium:

$$\begin{aligned}
 \text{PPTF}_{\text{asH}} = f_{\text{Ha}} & \left[\left(Q_f x_f C_{\text{sfHc}} t_{\text{ff}} + Q_g x_g C_{\text{sgHc}} t_{\text{fg}} + Q_h x_h C_{\text{shHc}} t_{\text{fh}} \right. \right. \\
 & \left. \left. + 1000 Q_f x_f Q_d W_f t_{\text{ff}} C_{\text{sH}} / C_{\text{sH}} \right) t_{\text{ca}} S_{\text{A-TaH}} / \left[\left(f_{\text{Hf}} Q_f t_{\text{ff}} \right. \right. \right. \\
 & \left. \left. \left. + f_{\text{Hd}} Q_d W_f Q_f t_{\text{ff}} + f_{\text{Hg}} Q_g t_{\text{fg}} + f_{\text{Hh}} Q_h t_{\text{fh}} + Q_w t_{\text{fw}} / 9 \right) 365.25 \right] \right] \quad (\text{D.4})
 \end{aligned}$$

where PPTF_{asH} = partial pathway transfer factor for animal product type a for tritium, per unit initial concentration of tritium in soil (pCi•y/kg wet-weight animal product per pCi•y/g for a year of residential scenario)

f_{Hd} = fraction of hydrogen in soil d (kg hydrogen/ kg dry-weight soil)

f_{Hf} = fraction of hydrogen in fresh forage f (kg hydrogen/kg wet-weight forage)

f_{Ha} = fraction of hydrogen in animal product a (kg hydrogen/kg wet-weight animal product)

f_{Hg} = fraction of hydrogen in stored grain g (kg hydrogen/kg wet-weight grain)

f_{Hh} = fraction of hydrogen in stored hay h (kg hydrogen/kg wet-weight hay)

Q_d = fraction of forage intake that is soil (kg dry-weight soil/kg dry-weight forage)

Q_f = consumption rate of fresh forage by the animal (kg wet-weight forage/d)

Q_g = consumption rate of stored grain by the animal (kg wet-weight grain/d)

Q_h = consumption rate of stored hay by the animal (kg wet-weight hay/d)

Q_w = consumption rate of water by the animal (kg/d)

W_f = factor for conversion of forage plant mass from a dry-weight to wet-weight basis (kg dry-weight forage/kg wet-weight forage)

9 = conversion factor for environmental water to hydrogen based on the molecular components of water (kg water/kg hydrogen)

C_{sfHc} = concentration factor for tritium in fresh forage plant f at time of consumption by animal, per unit initial concentration of tritium in soil (pCi/kg wet-weight forage per pCi/g dry-weight soil)

C_{sgHc} = concentration factor for tritium in stored grain plant g at time of consumption by animal, per unit initial concentration of tritium in soil (pCi/kg wet-weight grain per pCi/g dry-weight soil)

C_{shHc} = concentration factor for tritium in stored hay plant h at time of consumption by animal, per unit initial concentration of tritium in soil (pCi/kg wet-weight hay per pCi/g dry-weight soil)

t_{ff} = time period over which the animal is fed fresh forage (d)

Appendix D

t_{fg} = time period over which the animal is fed stored grain (d)

t_{fh} = time period over which the animal is fed stored hay (d)

t_{ca} = time period over which the animal product is consumed by humans (d for a year of residential scenario)

t_{fw} = time period over which the animal is fed water (d)

SA_{TaH} = specific activity equivalence of animal product type a and the specific activity of the total tritium and hydrogen intakes (pCi tritium/kg hydrogen in animal product per pCi tritium intake/total hydrogen intake)

x_f = fraction of animal is intake of forage that is contaminated (dimensionless)

x_g = fraction of animal is intake of stored grain that is contaminated (dimensionless)

x_h = fraction of animal is intake of stored hay that is contaminated (dimensionless)

1000 = unit conversion factor (g/kg).

D.2 Transfer of Tritium from Irrigation Water to Plants and Animal Products

The concentration of tritium in plants from contamination by irrigation with ground water is evaluated based on equilibrium between water and the plant's moisture concentration. For a unit initial tritium concentration in water (pCi/L) and for unit density of water (1 kg/L), the plant concentration is evaluated as follows:

$$C_{wvHh} = 9 f_{Hv} C_{wH} SA_{wvH}/C_{wH} \quad (D.5)$$

where C_{wvHh} = concentration factor for tritium in food type v at harvest from unit average concentration of tritium in water (pCi/kg wet-weight plant per pCi/L water)

C_{wH} = average concentration of tritium in water (pCi/L water)

f_{Hv} = fraction of hydrogen in total vegetation (kg hydrogen/kg wet-weight plant)

SA_{wvH} = specific activity equivalence of plant type v and tritium in water (pCi tritium/kg hydrogen in wet-weight plant per pCi tritium/kg hydrogen in water)

9 = conversion from environmental water to hydrogen based on molecular components of water (kg water/kg hydrogen).

The partial pathway transfer factor for food crops for tritium in water is evaluated using Equation (D.2), with the subscript w replacing subscript s:

$$PPTF_{vwH} = C_{wvHh} t_{cv} / 365.25 \quad (D.6)$$

where $PPTF_{vwH}$ = partial pathway transfer factor for tritium in food type v for irrigation with contaminated water, per unit average concentration of tritium in water (pCi•y/kg wet-weight plant per pCi/L water for a year of residential scenario)

C_{wvHh} = concentration factor for tritium in crop type v from root uptake at time of harvest, for unit average concentration of tritium in water (pCi/kg wet-weight plant per pCi/L water)

t_{cv} = time period over which food type v is consumed (d for a year of residential scenario)

365.25 = unit conversion factor (d/y).

The partial pathway transfer factor for tritium from water to animal products is based on tritium concentration in animal feed, evaluated by Equation (D.5) for forage crops and stored hay and grain crops. The animals are also assumed to drink contaminated water and ingest contaminated soil. The partial pathway transfer factors are calculated as follows:

$$PPTF_{awH} = \left[f_{Ha} \left(Q_f x_f C_{wfHc} t_{ff} + Q_g x_g C_{wgHc} t_{fg} + Q_h x_h C_{whHc} t_{fh} + Q_d W_f Q_f x_f C_{wfHd} t_{ff} + Q_w x_w C_{wwHc} t_{fw} \right) t_{ca} SA_{TaH} \right] / \left(f_{Hf} Q_f t_{ff} + f_{Hg} Q_g t_{fg} + f_{Hh} Q_h t_{fh} + f_{Hd} Q_d W_f Q_f t_{ff} + Q_w t_{fw} / 9 \right) 365.25 \quad (D.7)$$

where $PPTF_{awH}$ = partial pathway transfer factor for animal product type a for tritium, for unit average concentration of tritium in water (pCi•y/kg wet-weight animal product per pCi/L water for a year of residential scenario)

C_{wfHc} = concentration factor for tritium in fresh forage plant f at time of animal consumption, from unit average concentration of tritium in water (pCi/kg wet-weight forage per pCi/L water)

C_{wsHc} = concentration factor for tritium in stored feed plant s at time of animal consumption, from unit average concentration of tritium in water (pCi/kg wet-weight stored feed per pCi/L water)

C_{wwHc} = concentration factor for tritium in water per unit average concentration of tritium in water (added for clarity) (pCi/L per pCi/L)

C_{wfHd} = concentration factor for tritium in soil at time of animal consumption of soil per unit average concentration of tritium in water (pCi/kg dry-weight soil per pCi/L water)

SA_{TaH} = specific activity equivalence factor for tritium in animal product a (pCi tritium/kg hydrogen in animal product per total pCi tritium in fresh forage, stored feed, soil, and water/kg hydrogen in fresh forage, stored feed, soil, and water)

x_w = fraction of animal water intake that is contaminated (dimensionless)

Appendix D

and other terms are as previously defined. The concentration factor for tritium in soil, C_{wfHd} , is evaluated from the total deposition of tritium to soil from irrigation. The deposition rate is evaluated as per Equation (5.58). For tritium, the expression is written as follows:

$$R_{wsHf} = IR / P_s \left[C_{wH} / C_{wH} \right] \quad (D.8)$$

where R_{wsHf} = deposition rate of tritium from irrigation water to soil during the forage-feeding period per unit activity of tritium in irrigation water (pCi/d•kg dry-weight soil per pCi/L water)

IR = annual average application rate of irrigation water ($L/m^2 \cdot d$)

P_s = areal soil density (kg dry-weight soil/ m^2)

C_{wH} = average concentration of tritium in water over the current 1-year period (pCi/L).

The average concentration in soil is evaluated as the deposition, accumulation and, time-integral over the forage-feeding period, divided by the forage-feeding period. Because tritium has a relatively long half-life, the average soil concentration factor can be expressed as follows

$$C_{wfHd} = R_{wsHf} t_{ff} / 2 \quad (D.9)$$

where terms are as previously defined.

D.3 Special Parameters for the Tritium Model for Crops and Animal Products

The tritium model for agricultural pathway transfer factors uses several special parameters. Values for these parameters were taken from Napier et al. (1988) and are given in Table D.1.

Table D.1 Tritium agricultural model parameter values*

Parameter Description	Value	
Fraction of food plant that is hydrogen:		
Leafy vegetables	0.1	
Other vegetables	0.1	
Fruit	0.1	
Grain	0.068	
Fraction of animal product that is hydrogen:		
Beef	0.10	
Poultry	0.10	
Milk	0.11	
Eggs	0.11	
Fraction of animal feeds that is hydrogen:		
Beef	Forage	0.1
	Stored hay	0.1
	Stored grain	0.068
Poultry	Forage	0.1
	Stored hay	0.1
	Stored grain	0.068
Milk	Forage	0.1
	Stored hay	0.1
	Stored grain	0.068
Eggs	Forage	0.1
	Stored hay	0.1
	Stored grain	0.068
Fraction of soil that is hydrogen:	0.011**	
Soil moisture content (kg/kg):	0.1	

*From Napier et al. (1988).

**Evaluated as soil moisture content divided by 9.

D.4 References

Diabate, S., and S. Strack. 1990. *Doses Due to Tritium Releases by NET-Data Base and Relevant Parameters on Biological Tritium Behavior*. KfK4713, Kernforschungszentrum Karlsruhe, GmbH, Karlsruhe, Germany.

Johnson, J. R., E. S. Lamothe, J. S. Jackson, and R. G. C. McElroy. 1988. "Metabolism and Dosimetry of Tritium from Tritium Gas Contaminated Surfaces." *Fusion Technology* 14(2):1147-1152.

Appendix D

- Killough, G. C., and D. C. Kocher. 1988. "A Model for Global Cycling of Tritium." *Fusion Technology* 14(2):1115-1120.
- Moghissi, A. A., and M. W. Carter, eds. 1973. *Tritium*. CONF-710809, Oak Ridge National Laboratory, Oak Ridge, Tennessee.
- Murphy, C. E., Jr. 1986. "Modelling Tritium Transport in the Environment." *Radiation Protection Dosimetry* 16:51-58.
- Murphy, C. E., Jr. 1990. *The Transport, Dispersion, and Cycling of Tritium in the Environment*. WSRC-RP-90-462, Westinghouse Savannah River Company, Aiken, South Carolina.
- Napier, B. A., R. A. Peloquin, D. L. Strenge, and J. V. Ramsdell. 1988. *Hanford Environmental Dosimetry Upgrade Project, GENII - the Hanford Environmental Radiation Dosimetry Software Package*. PNL-6584, Vols. 1-3, Pacific Northwest Laboratory, Richland, Washington.
- National Council on Radiation Protection and Measurements (NCRP). 1979. *Tritium in the Environment*. NCRP Report No. 62, NCRP, Bethesda, Maryland.
- Neil, B. C. J. 1990. *An Environmental Pathway Model for Chronic Releases of Elemental Tritium*. Presented at the workshop on Tritium Safety and Environmental Effects, Aiken, South Carolina.
- Straume, T. 1991. *Health Risks From Exposure to Tritium*. UCRL-LR-105088, Lawrence Livermore National Laboratory, University of California, Livermore, California.

Appendix E

Supplemental Data

Appendix E

Supplemental Data

This appendix contains supplemental data needed in the calculation of annual total effective dose equivalents (TEDEs) for the residual radioactive contamination scenarios defined in this study. The tables provided in this appendix are shown in a computer-readable form, anticipating their direct use in user-friendly software implementing the scenario/pathway analysis. The numbers of significant figures shown in each table were obtained from primary references and are included for completeness.

E.1 Contents and Units of Tables

Table E.1 contains radioactive decay data and decay-chain specifications for the listing of radionuclides considered in this study. As described in Section 6.1.2, the radioactive decay database contains information taken directly from ICRP Publication 38 (ICRP 1983). The database contains a data set for each radionuclide or chain, except for natural thorium or natural uranium, for which dose factors are calculated from the radionuclides in the decay chain. The entries are organized by increasing atomic number and by decay chain. Within each chain, members follow according to their decay sequence. Progeny radionuclides are treated as implicit or explicit, as defined in Section 6.1.1. The columns in Table E.1 include listings for 1) parent radionuclide, 2) progeny radionuclides in the chain, 3) radioactive half-life (in days), 4) position of each radionuclide in the chain, 5) branching information for the first parent of each radionuclide (index and fraction), 6) branching information for the second parent, if any, of each radionuclide (index and fraction), and 7) atomic number.

Tables E.2 through E.5 contain the standardized databases of external and internal effective dose equivalent factors, committed effective dose conversion factors, and the organ dose equivalent factors used in this generic screening analysis. These factors are obtained from recent Federal Guidance published by the EPA, implementing the recommendations of the ICRP (Eckerman, Wolbarst, and Richardson 1988; Eckerman and Ryman 1992). Entries are included for each parent radionuclide with implicit progeny immediately following the parent entry. Implicit progeny are signified by an entry showing in the second column of each table.

Table E.2 lists the internal committed effective dose equivalent (CEDE) and the external effective dose equivalent factors. The columns in Table E.2 include listings for 1) radionuclide, 2) implicit progeny fraction, 3) internal committed effective dose equivalent for ingestion (Sv/Bq), 4) internal CEDE for inhalation (Sv/Bq), and 5) external effective dose equivalents for surface sources (Sv/d per Bq/m²) and volume sources with 15-cm thickness (Sv/d per Bq/m³). The implicit progeny fraction is the parameter F_j used in Equation (6.7) to calculate combined dose factors for parent radionuclides with implicit (short-lived) progeny.

Tables E.3 through E.5 contain ingestion organ dose equivalent factors for use in the drinking water scenario. Each table contains columns showing the radionuclide, implicit progeny fraction, and organ dose equivalent factors in units of Sv per Bq ingested. Table E.3 includes factors for adrenals, urinary bladder wall (Bld Wall), bone surface (B Surface), brain, breast, stomach wall (S Wall), and small intestine wall (SI Wall). Table E.4 includes factors for upper large intestine wall (ULI Wall), lower large intestine wall (LLI Wall), kidneys, liver, lungs, ovaries, and pancreas. Table E.5 includes factors for red bone marrow (R Marrow), skin, spleen, testes, thymus, thyroid, and uterus.

Appendix E

Table E.6 lists by radionuclide the inhalation translocation class and the gastrointestinal (GI) tract uptake fractions (f_1) used in this study. In most cases, the solubility class selection will maximize the potential inhalation dose. For plutonium, the solubility class represents the most common chemical form that will likely be encountered in environmental situations. For the other radionuclides, the translocation classes and GI uptake fractions are defined for the combination resulting in the highest dose.

E.2 References

Eckerman, K. F., and J. C. Ryman. 1992. *Dose Coefficients for External Exposure to Radionuclides Distributed in Air, Water, and Soil*. Federal Guidance Report No. 12, U.S. Environmental Protection Agency, Washington, D.C.

Eckerman, K. F., A. B. Wolbarst, and A. C. B. Richardson. 1988. *Limiting Values of Radionuclide Intake and Air Concentration and Dose Conversion Factors for Inhalation, Submersion, and Ingestion*. Federal Guidance Report No. 11, EPA-520/1-88-020, U.S. Environmental Protection Agency, Washington, D.C.

International Commission on Radiation Protection (ICRP). 1983. *Radionuclide Transformations - Energy and Intensity of Emissions*. ICRP Publication 38, vol. 11-13, Pergamon Press, New York.

Table E.1 Radioactive decay data and decay chain specifications

Parent radio- nuclide ⁺	Progeny in chain	Half-life (d)*	Position in chain	Branching information				Atomic Number**
				First parent		Second parent		
				Index	Fraction	Index	Fraction	
³ H		4.51E+03	1					1
¹⁰ Be		5.84E+08	1					4
¹⁴ C		2.09E+06	1					6
¹⁸ F		7.62E-02	1					9
²² Na		9.50E+02	1					11
²⁴ Na		6.25E-01	1					11
³² P		1.43E+01	1					15
³³ P		2.54E+01	1					15
³⁵ S		8.74E+01	1					16
³⁶ Cl		1.10E+08	1					17
⁴⁰ K		4.68E+11	1					19
⁴¹ Ca		5.11E+07	1					20
⁴⁵ Ca		1.63E+02	1					20
⁴⁶ Sc		8.38E+01	1					21
⁵¹ Cr		2.77E+01	1					24
⁵⁴ Mn		3.13E+02	1					25
⁵⁶ Mn		1.07E-01	1					25
⁵⁵ Fe		9.86E+02	1					26
⁵⁹ Fe		4.45E+01	1					26
⁵⁷ Co		2.71E+02	1					27
⁵⁸ Co		7.08E+01	1					27
⁶⁰ Co		1.93E+03	1					27
⁵⁹ Ni		2.74E+07	1					28
⁶³ Ni		3.51E+04	1					28
⁶⁵ Ni		1.05E-01	1					28
⁶⁴ Cu		5.29E-01	1					29

Table E.1 Radioactive decay data and decay chain specifications (Continued)

Parent radio- nuclide ⁺	Progeny in chain	Half-life (d)*	Position in chain	Branching information				Atomic Number**
				First parent		Second parent		
				Index	Fraction	Index	Fraction	
⁶⁵ Zn		2.44E+02	1					30
^{69m} Zn		5.73E-01	1					30
⁶⁹ Zn				1	0.9997			
⁶⁹ Zn		3.96E-02	1					30
⁷⁶ As		1.10E+00	1					33
⁷⁵ Se		1.20E+02	1					34
⁷⁹ Se		2.37E+07	1					34
⁸² Br		1.47E+00	1					35
⁸³ Br		9.96E-02	1					35
	^{83m} Kr			1	1.0000			
⁸⁴ Br		2.21E-02	1					35
⁸⁶ Rb		1.87E+01	1					37
⁸⁸ Rb		1.24E-02	1					37
⁸⁹ Rb		1.06E-02	1					37
	⁸⁹ Sr	5.05E+01	2	1	1.0000	0	0.0000	38
⁸⁵ Sr		6.48E+01	1					38
⁸⁹ Sr		5.05E+01	1					38
⁹⁰ Sr		1.06E+04	1					38
	⁹⁰ Y	2.67E+00	2	1	1.0000	0	0.0000	39
⁹¹ Sr		3.96E-01	1					38
	^{91m} Y			1	0.5780			
⁹¹ Y		5.85E+01	2	1	1.0000	0	0.0000	39
⁹⁰ Y		2.67E+00	1					39
^{91m} Y		3.45E-02	1					39
	⁹¹ Y	5.85E+01	2	1	1.0000	0	0.0000	39
⁹¹ Y		5.85E+01	1					39
⁹² Y		1.48E-01	1					39
⁹³ Y		4.21E-01	1					39
	⁹³ Zr	5.59E+08	2	1	1.0000	0	0.0000	40
	^{93m} Nb	4.97E+03	3	2	1.0000	0	0.0000	41
⁹³ Zr		5.59E+08	1					40
	^{93m} Nb	4.97E+03	2	1	1.0000	0	0.0000	41
⁹³ Zr+C		(Same data as for named radionuclide)						
⁹⁵ Zr		6.40E+01	1					40
	^{95m} Nb	3.61E+00	2	1	0.0070	0	0.0000	41
	⁹⁵ Nb	3.52E+01	3	2	1.0000	1	0.9930	41

Table E.1 Radioactive decay data and decay chain specifications (Continued)

Parent radio- nuclide ⁺	Progeny in chain	Half-life (d)*	Position in chain	Branching information				Atomic Number**																																																																																																																																																																																																																																																																																												
				First parent		Second parent																																																																																																																																																																																																																																																																																														
				Index	Fraction	Index	Fraction																																																																																																																																																																																																																																																																																													
⁹⁷ Zr	^{97m} Nb ⁹⁷ Nb	7.04E-01	1	1	0.9470			40																																																																																																																																																																																																																																																																																												
				1	0.0530				^{93m} Nb		4.97E+03	1					41	⁹⁴ Nb		7.41E+06	1					41	^{95m} Nb		3.61E+00	1					41		⁹⁵ Nb	3.52E+01	2	1	1.0000	0	0.0000	41	⁹⁵ Nb	3.52E+01	1					41	^{97m} Nb		6.94E-04	1					41		⁹⁷ Nb	5.01E-02	2	1	1.0000	0	0.0000	41	⁹⁷ Nb	5.01E-02	1					41	⁹³ Mo		1.28E+06	1					42		^{93m} Nb	4.97E+03	2	1	1.0000	0	0.0000	41	⁹⁹ Mo	2.75E+00	1					42		^{99m} Tc			1	0.8760					⁹⁹ Tc	7.78E+07	2	1	1.0000	0	0.0000	43	^{99m} Tc		2.51E-01	1					43		⁹⁹ Tc	7.78E+07	2	1	1.0000	0	0.0000	43	⁹⁹ Tc	7.78E+07	1					43	¹⁰¹ Tc		9.86E-03	1					43	¹⁰³ Ru		3.93E+01	1					44		^{103m} Rh	3.90E-02	2	1	0.9970	0	0.0000	45	¹⁰⁵ Ru	1.85E-01	1					44		¹⁰⁵ Rh	1.47E+00	2	1	1.0000	0	0.0000	45	¹⁰⁶ Ru	3.68E+02	1					44		¹⁰⁶ Rh			1	1.0000				^{103m} Rh		3.90E-02	1					45	¹⁰⁵ Rh		1.47E+00	1					45	¹⁰³ Pd		1.70E+01	1					46		^{103m} Rh			1	0.9997				¹⁰⁷ Pd	2.37E+09	1					46	¹⁰⁹ Pd		5.59E-01	1					46	^{110m} Ag		2.50E+02	1					47		¹¹⁰ Ag			1	0.0133				¹¹¹ Ag	7.45E+00	1					47	¹⁰⁹ Cd		4.64E+02	1
^{93m} Nb		4.97E+03	1					41																																																																																																																																																																																																																																																																																												
⁹⁴ Nb		7.41E+06	1					41																																																																																																																																																																																																																																																																																												
^{95m} Nb		3.61E+00	1					41																																																																																																																																																																																																																																																																																												
	⁹⁵ Nb	3.52E+01	2	1	1.0000	0	0.0000	41																																																																																																																																																																																																																																																																																												
⁹⁵ Nb		3.52E+01	1					41																																																																																																																																																																																																																																																																																												
^{97m} Nb		6.94E-04	1					41																																																																																																																																																																																																																																																																																												
	⁹⁷ Nb	5.01E-02	2	1	1.0000	0	0.0000	41																																																																																																																																																																																																																																																																																												
⁹⁷ Nb		5.01E-02	1					41																																																																																																																																																																																																																																																																																												
⁹³ Mo		1.28E+06	1					42																																																																																																																																																																																																																																																																																												
	^{93m} Nb	4.97E+03	2	1	1.0000	0	0.0000	41																																																																																																																																																																																																																																																																																												
⁹⁹ Mo		2.75E+00	1					42																																																																																																																																																																																																																																																																																												
	^{99m} Tc			1	0.8760																																																																																																																																																																																																																																																																																															
		⁹⁹ Tc	7.78E+07	2	1	1.0000	0	0.0000	43																																																																																																																																																																																																																																																																																											
^{99m} Tc		2.51E-01	1					43																																																																																																																																																																																																																																																																																												
	⁹⁹ Tc	7.78E+07	2	1	1.0000	0	0.0000	43																																																																																																																																																																																																																																																																																												
⁹⁹ Tc		7.78E+07	1					43																																																																																																																																																																																																																																																																																												
¹⁰¹ Tc		9.86E-03	1					43																																																																																																																																																																																																																																																																																												
¹⁰³ Ru		3.93E+01	1					44																																																																																																																																																																																																																																																																																												
	^{103m} Rh	3.90E-02	2	1	0.9970	0	0.0000	45																																																																																																																																																																																																																																																																																												
¹⁰⁵ Ru		1.85E-01	1					44																																																																																																																																																																																																																																																																																												
	¹⁰⁵ Rh	1.47E+00	2	1	1.0000	0	0.0000	45																																																																																																																																																																																																																																																																																												
¹⁰⁶ Ru		3.68E+02	1					44																																																																																																																																																																																																																																																																																												
	¹⁰⁶ Rh			1	1.0000																																																																																																																																																																																																																																																																																															
^{103m} Rh		3.90E-02	1					45																																																																																																																																																																																																																																																																																												
¹⁰⁵ Rh		1.47E+00	1					45																																																																																																																																																																																																																																																																																												
¹⁰³ Pd		1.70E+01	1					46																																																																																																																																																																																																																																																																																												
	^{103m} Rh			1	0.9997																																																																																																																																																																																																																																																																																															
¹⁰⁷ Pd		2.37E+09	1					46																																																																																																																																																																																																																																																																																												
¹⁰⁹ Pd		5.59E-01	1					46																																																																																																																																																																																																																																																																																												
^{110m} Ag		2.50E+02	1					47																																																																																																																																																																																																																																																																																												
	¹¹⁰ Ag			1	0.0133																																																																																																																																																																																																																																																																																															
¹¹¹ Ag		7.45E+00	1					47																																																																																																																																																																																																																																																																																												
¹⁰⁹ Cd		4.64E+02	1					48																																																																																																																																																																																																																																																																																												

Table E.1 Radioactive decay data and decay chain specifications (Continued)

Parent radio- nuclide ⁺	Progeny in chain	Half-life (d)*	Position in chain	Branching information				Atomic Number**
				First parent		Second parent		
				Index	Fraction	Index	Fraction	
^{113m} Cd		4.97E+03	1					48
^{115m} Cd		4.46E+01	1					48
¹¹⁵ Cd		2.23E+00	1					48
	^{115m} In			1	1.0000			
¹¹¹ In		2.83E+00	1					49
^{114m} In		4.95E+01	1					49
	¹¹⁴ In			1	0.9570			
^{115m} In		1.87E-01	1					49
^{117m} Sn		1.36E+01	1					50
^{119m} Sn		2.93E+02	1					50
^{121m} Sn		2.01E+04	1					50
	¹²¹ Sn	1.13E+00	2	1	0.7760	0	0.0000	50
¹²¹ Sn		1.13E+00	1					50
¹²³ Sn		1.29E+02	1					50
¹²⁵ Sn		9.64E+00	1					50
	¹²⁵ Sb	1.01E+03	2	1	1.0000	0	0.0000	51
	^{125m} Te	5.80E+01	3	2	0.2280	0	0.0000	52
¹²⁶ Sn		3.65E+07	1					50
^{126m} Sb				1	1.0000			
	¹²⁶ Sb	1.24E+01	2	1	0.1400	0	0.0000	51
¹²⁶ Sn+C		(Same data as for named radionuclide)						
¹²⁴ Sb		6.02E+01	1					51
¹²⁵ Sb		1.01E+03	1					51
	^{125m} Te	5.80E+01	2	1	0.2280	0	0.0000	52
^{126m} Sb		1.32E-02	1					51
	¹²⁶ Sb	1.24E+01	2	1	0.1400	0	0.0000	51
¹²⁶ Sb		1.24E+01	1					51
¹²⁷ Sb		3.85E+00	1					51
	^{127m} Te	1.09E+02	2	1	0.1760	0	0.0000	52
	¹²⁷ Te	3.90E-01	3	2	0.9760	1	0.8240	52
^{123m} Te		1.20E+02	1					52
^{125m} Te		5.80E+01	1					52
^{127m} Te		1.09E+02	1					52
	¹²⁷ Te	3.90E-01	2	1	0.9760	0	0.0000	52
¹²⁷ Te		3.90E-01	1					52
^{129m} Te		3.36E+01	1					52
	¹²⁹ Te			1	0.6500			
	¹²⁹ I	5.73E+09	2	1	1.0000	0	0.0000	53

Table E.1 Radioactive decay data and decay chain specifications (Continued)

Parent radio- nuclide ⁺	Progeny in chain	Half-life (d)*	Position in chain	Branching information				Atomic Number**
				First parent		Second parent		
				Index	Fraction	Index	Fraction	
¹²⁹ Te		4.83E-02	1					52
	¹²⁹ I	5.73E+09	2	1	1.0000	0	0.0000	53
^{131m} Te		1.25E+00	1					52
	¹³¹ Te			1	0.2220			
	¹³¹ I	8.04E+00	2	1	1.0000	0	0.0000	53
¹³¹ Te		1.74E-02	1					52
	¹³¹ I	8.04E+00	2	1	1.0000	0	0.0000	53
¹³² Te		3.26E+00	1					52
	¹³² I			1	1.0000			
^{133m} Te		3.85E-02	1					52
	¹³³ Te			1	0.1300			
	¹³³ I	8.67E-01	2	1	1.0000	0	0.0000	53
¹³³ Te		8.65E-03	1					52
	¹³³ I	8.67E-01	2	1	1.0000	0	0.0000	53
¹³⁴ Te		2.90E-02	1					52
	¹³⁴ I			1	1.0000			
¹²⁵ I		6.01E+01	1					53
¹²⁹ I		5.73E+09	1					53
¹³⁰ I		5.15E-01	1					53
¹³¹ I		8.04E+00	1					53
¹³² I		9.58E-02	1					53
¹³³ I		8.67E-01	1					53
¹³⁴ I		3.65E-02	1					53
¹³⁵ I		2.75E-01	1					53
	^{135m} Xe			1	0.1540			
^{134m} Cs		1.21E-01	1					55
	¹³⁴ Cs	7.53E+02	2	1	1.0000	0	0.0000	55
¹³⁴ Cs		7.53E+02	1					55
¹³⁵ Cs		8.40E+08	1					55
¹³⁶ Cs		1.31E+01	1					55
¹³⁷ Cs		1.10E+04	1					55
	^{137m} Ba			1	0.9460			
¹³⁸ Cs		2.24E-02	1					55
¹³⁹ Ba		5.74E-02	1					56
¹⁴⁰ Ba		1.27E+01	1					56
	¹⁴⁰ La	1.68E+00	2	1	1.0000	0	0.0000	57
¹⁴¹ Ba		1.27E-02	1					56
	¹⁴¹ La	1.64E-01	2	1	1.0000	0	0.0000	57
	¹⁴¹ Ce	3.25E+01	3	2	1.0000	0	0.0000	58

Appendix E

Table E.1 Radioactive decay data and decay chain specifications (Continued)

Parent radio- nuclide ⁺	Progeny in chain	Half-life (d)*	Position in chain	Branching information				Atomic Number**
				First parent		Second parent		
				Index	Fraction	Index	Fraction	
¹⁴² Ba	¹⁴² La	7.36E-03	1					56
		6.42E-02	2	1	1.0000	0	0.0000	57
¹⁴⁰ La		1.68E+00	1					57
¹⁴¹ La	¹⁴¹ Ce	1.64E-01	1					57
		3.25E+01	2	1	1.0000	0	0.0000	58
¹⁴² La		6.42E-02	1					57
¹⁴¹ Ce		3.25E+01	1					58
¹⁴³ Ce	¹⁴³ Pr	1.38E+00	1					58
		1.36E+01	2	1	1.0000	0	0.0000	59
¹⁴⁴ Ce		2.84E+02	1					58
	^{144m} Pr			1	0.0178			
	¹⁴⁴ Pr			1	1.0000			
¹⁴³ Pr		1.36E+01	1					59
¹⁴⁴ Pr		1.20E-02	1					59
¹⁴⁷ Nd	¹⁴⁷ Pm	1.10E+01	1					60
		9.58E+02	2	1	1.0000	0	0.0000	61
¹⁴⁷ Pm		9.58E+02	1					61
^{148m} Pm	¹⁴⁸ Pm	4.13E+01	1					61
		5.37E+00	2	1	0.0460	0	0.0000	61
¹⁴⁸ Pm		5.37E+00	1					61
¹⁴⁹ Pm		2.21E+00	1					61
¹⁵¹ Pm	¹⁵¹ Sm	1.18E+00	1					61
		3.29E+04	2	1	1.0000	0	0.0000	62
¹⁴⁷ Sm		3.87E+13	1					62
¹⁵¹ Sm		3.29E+04	1					62
¹⁵³ Sm		1.95E+00	1					62
¹⁵² Eu		4.87E+03	1					63
¹⁵⁴ Eu		3.21E+03	1					63
¹⁵⁵ Eu		1.81E+03	1					63
¹⁵⁶ Eu		1.52E+01	1					63
¹⁵³ Gd		2.42E+02	1					64
¹⁶⁰ Tb		7.23E+01	1					65
^{166m} Ho		4.38E+05	1					67

Table E.1 Radioactive decay data and decay chain specifications (Continued)

Parent radio- nuclide ⁺	Progeny in chain	Half-life (d)*	Position in chain	Branching information				Atomic Number**
				First parent		Second parent		
				Index	Fraction	Index	Fraction	
¹⁸¹ W		1.21E+02	1					74
¹⁸⁵ W		7.51E+01	1					74
¹⁸⁷ W		9.96E-01	1					74
	¹⁸⁷ Re	1.72E+13	2	1	1.0000	0	0.0000	75
¹⁸⁷ Re		1.72E+13	1					75
¹⁸⁵ Os		9.40E+01	1					76
¹⁹¹ Os		1.54E+01	1					76
¹⁹² Ir		7.40E+01	1					77
¹⁹⁸ Au		2.70E+00	1					79
²⁰³ Hg		4.66E+01	1					80
²¹⁰ Pb		8.15E+03	1					82
	²¹⁰ Bi	5.01E+00	2	1	1.0000	0	0.0000	83
	²¹⁰ Po	1.38E+02	3	2	1.0000	0	0.0000	84
²¹² Pb		4.43E-01	1					82
	²¹² Bi			1	1.0000			
	²¹² Po			1	0.6407			
	²⁰⁸ Tl			1	0.3593			
²¹⁰ Bi		5.01E+00	1					83
	²¹⁰ Po	1.38E+02	2	1	1.0000	0	0.0000	84
²¹² Bi		4.20E-02	1					83
	²¹² Po			1	0.6407			
	²⁰⁸ Tl			1	0.3593			
²¹⁰ Po		1.38E+02	1					84
²²² Rn		3.82E+00	1					86
	²¹⁸ Po			1	1.0000			
	²¹⁴ Pb			1	1.0000			
	²¹⁴ Bi			1	1.0000			
	²¹⁴ Po			1	0.9998			
	²¹⁰ Pb	8.15E+03	2	1	1.0000	0	0.0000	82
	²¹⁰ Bi	5.01E+00	3	2	1.0000	0	0.0000	83
	²¹⁰ Po	1.38E+02	4	3	1.0000	0	0.0000	84

Table E.1 Radioactive decay data and decay chain specifications (Continued)

Parent radio- nuclide ⁺	Progeny in chain	Half-life (d)*	Position in chain	Branching information				Atomic Number**
				First parent		Second parent		
				Index	Fraction	Index	Fraction	
²²³ Ra		1.14E+01	1					88
	²¹⁹ Rn			1	1.0000			
	²¹⁵ Po			1	1.0000			
	²¹¹ Pb			1	1.0000			
	²¹¹ Bi			1	1.0000			
	²¹¹ Po			1	0.0028			
	²⁰⁷ Tl			1	0.9972			
²²⁴ Ra		3.66E+00	1					88
	²²⁰ Rn			1	1.0000			
	²¹⁶ Po			1	1.0000			
²²⁵ Ra	²¹² Pb	4.43E-01	2	1	1.0000	0	0.0000	82
		1.48E+01	1					88
	²²⁵ Ac	1.00E+01	2	1	1.0000	0	0.0000	89
²²⁶ Ra		5.84E+05	1					88
	²²² Rn	3.82E+00	2	1	1.0000	0	0.0000	86
	²¹⁰ Pb	8.15E+03	3	2	1.0000	0	0.0000	82
	²¹⁰ Bi	5.01E+00	4	3	1.0000	0	0.0000	83
	²¹⁰ Po	1.38E+02	5	4	1.0000	0	0.0000	84
²²⁶ Ra+C		(Same data as for named radionuclide)						
²²⁸ Ra		2.10E+03	1					88
	²²⁸ Ac			1	1.0000			
	²²⁸ Th	6.99E+02	2	1	1.0000	0	0.0000	90
	²²⁴ Ra	3.66E+00	3	2	1.0000	0	0.0000	88
	²¹² Pb	4.43E-01	4	3	1.0000	0	0.0000	82
²²⁵ Ac		1.00E+01	1					89
	²²¹ Fr			1	1.0000			
	²¹⁷ At			1	1.0000			
	²¹³ Bi			1	1.0000			
	²¹³ Po			1	0.9784			
	²⁰⁹ Tl			1	0.0216			
	²⁰⁹ Pb			1	1.0000			
²²⁷ Ac		7.95E+03	1					89
	²²³ Fr			1	0.0138			
	²²⁷ Th	1.87E+01	2	1	0.9862	0	0.0000	90
	²²³ Ra	1.14E+01	3	2	1.0000	1	0.0138	88
²²⁷ Ac+C		(Same data as for named radionuclide)						
²²⁸ Ac		2.55E-01	1					89
	²²⁸ Th	6.99E+02	2	1	1.0000	0	0.0000	90
	²²⁴ Ra	3.66E+00	3	2	1.0000	0	0.0000	88
	²¹² Pb	4.43E-01	4	3	1.0000	0	0.0000	82

Table E.1 Radioactive decay data and decay chain specifications (Continued)

Parent radio- nuclide ⁺	Progeny in chain	Half-life (d)*	Position in chain	Branching information				Atomic Number**
				First parent		Second parent		
				Index	Fraction	Index	Fraction	
²²⁷ Th		1.87E+01	1					90
	²²³ Ra	1.14E+01	2	1	1.0000	0	0.0000	88
²²⁸ Th		6.99E+02	1					90
	²²⁴ Ra	3.66E+00	2	1	1.0000	0	0.0000	88
	²¹² Pb	4.43E-01	3	2	1.0000	0	0.0000	82
²²⁸ Th+C		(Same data as for named radionuclide)						
²²⁹ Th		2.68E+06	1					90
	²²⁵ Ra	1.48E+01	2	1	1.0000	0	0.0000	88
	²²⁵ Ac	1.00E+01	3	2	1.0000	0	0.0000	89
²²⁹ Th+C		(Same data as for named radionuclide)						
²³⁰ Th		2.81E+07	1					90
	²²⁶ Ra	5.84E+05	2	1	1.0000	0	0.0000	88
	²²² Rn	3.82E+00	3	2	1.0000	0	0.0000	86
	²¹⁰ Pb	8.15E+03	4	3	1.0000	0	0.0000	82
	²¹⁰ Bi	5.01E+00	5	4	1.0000	0	0.0000	83
	²¹⁰ Po	1.38E+02	6	5	1.0000	0	0.0000	84
²³⁰ Th+C		(Same data as for named radionuclide)						
²³¹ Th		1.06E+00	1					90
	²³¹ Pa	1.20E+07	2	1	1.0000	0	0.0000	91
	²²⁷ Ac	7.95E+03	3	2	1.0000	0	0.0000	89
	²²⁷ Th	1.87E+01	4	3	0.9862	0	0.0000	90
	²²³ Ra	1.14E+01	5	4	1.0000	0	0.0000	88
²³² Th		5.13E+12	1					90
	²²⁸ Ra	2.10E+03	2	1	1.0000	0	0.0000	88
	²²⁸ Th	6.99E+02	3	2	1.0000	0	0.0000	90
	²²⁴ Ra	3.66E+00	4	3	1.0000	0	0.0000	88
	²¹² Pb	4.43E-01	5	4	1.0000	0	0.0000	82
²³² Th+C		(Same data as for named radionuclide)						
²³⁴ Th		2.41E+01	1					90
	^{234m} Pa			1	0.9980			91
	²³⁴ Pa			1	0.0020			91
	²³⁴ U	8.93E+07	2	1	1.0000	0	0.0000	92
²³¹ Pa		1.20E+07	1					91
	²²⁷ Ac	7.95E+03	2	1	1.0000	0	0.0000	89
	²²⁷ Th	1.87E+01	3	2	0.9862	0	0.0000	90
	²²³ Ra	1.14E+01	4	3	1.0000	0	0.0000	88
²³¹ Pa+C		(Same data as for named radionuclide)						
²³³ Pa		2.70E+01	1					91
	²³³ U	5.79E+07	2	1	1.0000	0	0.0000	92
	²²⁹ Th	2.68E+06	3	2	1.0000	0	0.0000	90
	²²⁵ Ra	1.48E+01	4	3	1.0000	0	0.0000	88

Table E.1 Radioactive decay data and decay chain specifications (Continued)

Parent radio- nuclide ⁺	Progeny in chain	Half-life (d)*	Position in chain	Branching information				Atomic Number**
				First parent		Second parent		
				Index	Fraction	Index	Fraction	
²³⁴ Pa ²³² U	²²⁵ Ac	1.00E+01	5	4	1.0000	0	0.0000	89
		2.79E-01	1					91
		2.63E+04	1					92
²³² U+C ²³³ U	²²⁸ Th	6.99E+02	2	1	1.0000	0	0.0000	90
	²²⁴ Ra	3.66E+00	3	2	1.0000	0	0.0000	88
	²¹² Pb	4.43E-01	4	3	1.0000	0	0.0000	82
		(Same data as for named radionuclide)						
²³³ U+C ²³⁴ U ²³⁵ U		5.79E+07	1					92
	²²⁹ Th	2.68E+06	2	1	1.0000	0	0.0000	90
	²²⁵ Ra	1.48E+01	3	2	1.0000	0	0.0000	88
²³³ U+C ²³⁴ U ²³⁵ U	²²⁵ Ac	1.00E+01	4	3	1.0000	0	0.0000	89
		(Same data as for named radionuclide)						
		8.93E+07	1					92
		2.57E+11	1					92
²³⁵ U+C ²³⁶ U ²³⁷ U	²³¹ Th	1.06E+00	2	1	1.0000	0	0.0000	90
	²³¹ Pa	1.20E+07	3	2	1.0000	0	0.0000	91
	²²⁷ Ac	7.95E+03	4	3	1.0000	0	0.0000	89
	²²⁷ Th	1.87E+01	5	4	0.9862	0	0.0000	90
	²²³ Ra	1.14E+01	6	5	1.0000	0	0.0000	88
		(Same data as for named radionuclide)						
²³⁵ U+C ²³⁶ U ²³⁷ U		8.55E+09	1					92
		6.75E+00	1					92
	²³⁷ Np	7.82E+08	2	1	1.0000	0	0.0000	93
²³⁸ U	²³³ Pa	2.70E+01	3	2	1.0000	0	0.0000	91
		1.63E+12	1					92
	²³⁴ Th	2.41E+01	2	1	1.0000	0	0.0000	90
	²³⁴ U	8.93E+07	3	2	1.0000	0	0.0000	92
	²³⁰ Th	2.81E+07	4	3	1.0000	0	0.0000	90
	²²⁶ Ra	5.84E+05	5	4	1.0000	0	0.0000	88
	²²² Rn	3.82E+00	6	5	1.0000	0	0.0000	86
	²¹⁰ Pb	8.15E+03	7	6	1.0000	0	0.0000	82
	²¹⁰ Bi	5.01E+00	8	7	1.0000	0	0.0000	83
	²¹⁰ Po	1.38E+02	9	8	1.0000	0	0.0000	84
		(Same data as for named radionuclide)						
²³⁸ U+C ²⁴⁰ U		5.88E-01	1					92
²³⁷ Np	^{240m} Np			1	1.0000			
		7.82E+08	1					93
	²³³ Pa	2.70E+01	2	1	1.0000	0	0.0000	91
	²³³ U	5.79E+07	3	2	1.0000	0	0.0000	92
	²²⁹ Th	2.68E+06	4	3	1.0000	0	0.0000	90
	²²⁵ Ra	1.48E+01	5	4	1.0000	0	0.0000	88

Table E.1 Radioactive decay data and decay chain specifications (Continued)

Parent radionuclide ⁺	Progeny in chain	Half-life (d)*	Position in chain	Branching information				Atomic Number**
				First parent		Second parent		
				Index	Fraction	Index	Fraction	
	²²⁵ Ac	1.00E+01	6	5	1.0000	0	0.0000	89
²³⁷ Np+C		(Same data as for named radionuclide)						
²³⁸ Np		2.12E+00	1					93
²³⁹ Np		2.36E+00	1					93
²³⁶ Pu		1.04E+03	1					94
	²³² U	2.63E+04	2	1	1.0000	0	0.0000	92
	²²⁸ Th	6.99E+02	3	2	1.0000	0	0.0000	90
	²²⁴ Ra	3.66E+00	4	3	1.0000	0	0.0000	88
	²¹² Pb	4.43E-01	5	4	1.0000	0	0.0000	82
²³⁷ Pu		4.53E+01	1					94
	²³⁷ Np	7.82E+08	2	1	1.0000	0	0.0000	93
	²³³ Pa	2.70E+01	3	2	1.0000	0	0.0000	91
²³⁸ Pu		3.20E+04	1					94
	²³⁴ U	8.93E+07	2	1	1.0000	0	0.0000	92
²³⁹ Pu		8.79E+06	1					94
²⁴⁰ Pu		2.39E+06	1					94
²⁴¹ Pu		5.26E+03	1					94
	²⁴¹ Am	1.58E+05	2	1	1.0000	0	0.0000	95
²⁴² Pu		1.37E+08	1					94
²⁴³ Pu		2.07E-01	1					94
²⁴⁴ Pu		3.02E+10	1					94
	²⁴⁰ U	5.88E-01	2	1	0.9988	0	0.0000	92
	²⁴⁰ Pu	2.39E+06	3	2	1.0000	0	0.0000	94
²⁴¹ Am		1.58E+05	1					95
^{242m} Am		5.55E+04	1					95
	²⁴² Am	6.68E-01	2	1	0.9952	0	0.0000	95
	²⁴² Cm	1.63E+02	3	2	0.8270	0	0.0000	96
	²⁴² Pu	1.37E+08	4	2	0.1730	0	0.0000	94
	²³⁸ Np	2.12E+00	5	1	0.0048	0	0.0000	93
	²³⁸ Pu	3.20E+04	6	5	1.0000	3	1.0000	94
²⁴² Am		6.68E-01	1					95
	²⁴² Cm	1.63E+02	2	1	0.8270	0	0.0000	96
	²⁴² Pu	1.37E+08	3	1	0.1730	0	0.0000	94
	²³⁸ Pu	3.20E+04	4	2	1.0000	0	0.0000	94
²⁴³ Am		2.70E+06	1					95
	²³⁹ Np	2.36E+00	2	1	1.0000	0	0.0000	93
	²³⁹ Pu	8.79E+06	3	2	1.0000	0	0.0000	94
²⁴² Cm		1.63E+02	1					96
	²³⁸ Pu	3.20E+04	2	1	1.0000	0	0.0000	94
²⁴³ Cm		1.04E+04	1					96
	²⁴³ Am	2.70E+06	2	1	0.0024	0	0.0000	95

Table E.1 Radioactive decay data and decay chain specifications (Continued)

Parent radionuclide ⁺	Progeny in chain	Half-life (d)*	Position in chain	Branching information				Atomic Number**
				First parent		Second parent		
				Index	Fraction	Index	Fraction	
	²³⁹ Np	2.36E+00	3	2	1.0000	0	0.0000	93
	²³⁹ Pu	8.79E+06	4	1	0.9976	3	1.0000	94
²⁴⁴ Cm		6.61E+03	1					96
	²⁴⁰ Pu	2.39E+06	2	1	1.0000	0	0.0000	94
²⁴⁵ Cm		3.10E+06	1					96
	²⁴¹ Pu	5.26E+03	2	1	1.0000	0	0.0000	94
	²⁴¹ Am	1.58E+05	3	2	1.0000	0	0.0000	95
²⁴⁶ Cm		1.73E+06	1					96
²⁴⁷ Cm		5.70E+09	1					96
	²⁴³ Pu			1	1.0000			
	²⁴³ Am	2.70E+06	2	1	1.0000	0	0.0000	95
	²³⁹ Np	2.36E+00	3	2	1.0000	0	0.0000	93
	²³⁹ Pu	8.79E+06	4	3	1.0000	0	0.0000	94
²⁴⁸ Cm		1.24E+08	1					96
²⁵² Cf		9.64E+02	1					98
	²⁴⁸ Cm	1.24E+08	2	1	0.9691	0	0.0000	96

+ Radionuclides with a "+C" representation use the same data as defined for the named radionuclide. The differences in the reported dose factors are due to differences in definition of initial activity for chain members. For the named radionuclide (without "+C") the progeny have zero initial activity. For the "+C" entries, the progeny have equilibrium initial activity.

* Values of radioactive half-life are given for all parent radionuclides and for all explicitly defined progeny. Blank entries signify that the radionuclide is short-lived and is considered to be an implicit progeny of the parent radionuclide.

** The atomic number is defined and used only for explicit radionuclides.

Table E.2 Internal committed effective dose equivalent and external effective dose equivalent factors

Radio-nuclide	Implicit progeny fraction	Ingestion (Sv/Bq)	Inhalation (Sv/Bq)	External	
				Surface (Sv/d per Bq/m ²)	15 cm* (Sv/d per Bq/m ³)
³ H		1.73E-11	1.73E-11	0.00E+00	0.00E+00
¹⁰ Be		1.26E-09	9.58E-08	3.56E-14	4.90E-16
¹⁴ C		5.64E-10	5.64E-10	1.39E-15	6.22E-18
¹⁸ F		3.31E-11	2.26E-11	8.73E-11	2.52E-12
²² Na		3.10E-09	2.07E-09	1.82E-10	5.45E-12
²⁴ Na		3.84E-10	3.27E-10	3.12E-10	1.02E-11
³² P		2.37E-09	4.19E-09	2.51E-13	5.18E-15
³³ P		2.48E-10	6.27E-10	3.85E-15	2.73E-17
³⁵ S		1.98E-10	6.69E-10	1.45E-15	6.88E-18
³⁶ Cl		8.18E-10	5.93E-09	5.81E-14	1.06E-15
⁴⁰ K		5.02E-09	3.34E-09	1.26E-11	3.95E-13
⁴¹ Ca		3.44E-10	3.64E-10	0.00E+00	0.00E+00
⁴⁵ Ca		8.55E-10	1.79E-09	3.98E-15	2.89E-17
⁴⁶ Sc		1.73E-09	8.01E-09	1.66E-10	5.01E-12
⁵¹ Cr		3.98E-11	9.03E-11	2.66E-12	7.56E-14
⁵⁴ Mn		7.48E-10	1.81E-09	7.01E-11	2.07E-12
⁵⁶ Mn		2.64E-10	1.02E-10	1.36E-10	4.23E-12
⁵⁵ Fe		1.64E-10	7.26E-10	0.00E+00	0.00E+00
⁵⁹ Fe		1.81E-09	4.00E-09	9.71E-11	2.97E-12
⁵⁷ Co		3.20E-10	2.45E-09	9.97E-12	2.29E-13
⁵⁸ Co		9.68E-10	2.94E-09	8.20E-11	2.42E-12
⁶⁰ Co		7.28E-09	5.91E-08	2.03E-10	6.26E-12
⁵⁹ Ni		5.67E-11	7.31E-10	0.00E+00	0.00E+00
⁶³ Ni		1.56E-10	1.70E-09	0.00E+00	0.00E+00
⁶⁵ Ni		1.68E-10	9.32E-11	4.45E-11	1.38E-12
⁶⁴ Cu		1.26E-10	7.48E-11	1.61E-11	4.67E-13
⁶⁵ Zn		3.90E-09	5.51E-09	4.78E-11	1.45E-12
^{69m} Zn		3.55E-10	2.20E-10	3.56E-11	1.02E-12
⁶⁹ Zn	0.9997	2.40E-11	1.06E-11	6.20E-14	1.02E-15
⁶⁹ Zn		2.40E-11	1.06E-11	6.20E-14	1.02E-15
⁷⁶ As		1.41E-09	1.01E-09	3.66E-11	1.08E-12
⁷⁵ Se		2.60E-09	2.29E-09	3.26E-11	8.75E-13
⁷⁹ Se		2.35E-09	2.66E-09	1.79E-15	8.60E-18
⁸² Br		4.62E-10	4.13E-10	2.20E-10	6.57E-12
⁸³ Br		2.47E-11	2.41E-11	7.02E-13	1.95E-14
^{83m} Kr	1.0000	0.00E+00	0.00E+00	3.28E-14	1.40E-17
⁸⁴ Br		4.91E-11	2.61E-11	1.38E-10	4.45E-12
⁸⁶ Rb		2.53E-09	1.79E-09	8.04E-12	2.41E-13
⁸⁸ Rb		4.71E-11	2.26E-11	5.14E-11	1.63E-12
⁸⁹ Rb		2.65E-11	1.16E-11	1.65E-10	5.18E-12
⁸⁵ Sr		5.34E-10	1.36E-09	4.32E-11	1.24E-12
⁸⁹ Sr		2.50E-09	1.12E-08	1.96E-13	3.99E-15

Table E.2 Internal committed effective dose equivalent and external effective dose equivalent factors (Continued)

Radio-nuclide	Implicit progeny fraction	Ingestion (Sv/Bq)	Inhalation (Sv/Bq)	External	
				Surface (Sv/d per Bq/m ²)	15 cm* (Sv/d per Bq/m ³)
⁹⁰ Sr		3.85E-08	3.51E-07	2.46E-14	3.21E-16
⁹¹ Sr		8.39E-10	4.49E-10	5.84E-11	1.74E-12
^{91m} Y	0.5780	1.12E-11	9.82E-12	4.52E-11	1.31E-12
⁹⁰ Y		2.91E-09	2.28E-09	4.60E-13	1.03E-14
^{91m} Y		1.12E-11	9.82E-12	4.52E-11	1.31E-12
⁹¹ Y		2.57E-09	1.32E-08	4.95E-13	1.31E-14
⁹² Y		5.15E-10	2.11E-10	2.18E-11	6.54E-13
⁹³ Y		1.23E-09	5.82E-10	7.87E-12	2.37E-13
⁹³ Zr		4.48E-10	8.67E-08	0.00E+00	0.00E+00
⁹⁵ Zr		1.02E-09	6.39E-09	6.24E-11	1.84E-12
⁹⁷ Zr		2.28E-09	1.17E-09	1.50E-11	4.51E-13
^{97m} Nb	0.9470	0.00E+00	0.00E+00	6.15E-11	1.81E-12
⁹⁷ Nb	0.0530	6.30E-11	2.24E-11	5.57E-11	1.63E-12
^{93m} Nb		1.41E-10	7.90E-09	8.11E-14	4.80E-17
⁹⁴ Nb		1.93E-09	1.12E-07	1.32E-10	3.91E-12
^{95m} Nb		6.22E-10	6.59E-10	5.41E-12	1.41E-13
⁹⁵ Nb		6.95E-10	1.57E-09	6.46E-11	1.90E-12
^{97m} Nb		0.00E+00	0.00E+00	6.15E-11	1.81E-12
⁹⁷ Nb		6.30E-11	2.24E-11	5.57E-11	1.63E-12
⁹³ Mo		3.64E-10	7.68E-09	4.61E-13	2.73E-16
⁹⁹ Mo		1.36E-09	1.07E-09	1.27E-11	3.65E-13
^{99m} Tc	0.8760	1.68E-11	8.80E-12	1.04E-11	2.51E-13
^{99m} Tc		1.68E-11	8.80E-12	1.04E-11	2.51E-13
⁹⁹ Tc		3.95E-10	2.25E-09	6.73E-15	5.79E-17
¹⁰¹ Tc		1.14E-11	4.84E-12	2.83E-11	8.03E-13
¹⁰³ Ru		8.24E-10	2.42E-09	4.00E-11	1.15E-12
¹⁰⁵ Ru		2.87E-10	1.23E-10	6.64E-11	1.94E-12
¹⁰⁶ Ru		7.40E-09	1.29E-07	0.00E+00	0.00E+00
¹⁰⁶ Rh	1.0000	0.00E+00	0.00E+00	1.83E-11	5.31E-13
^{103m} Rh		3.14E-12	1.38E-12	1.08E-13	1.13E-16
¹⁰⁵ Rh		3.99E-10	2.58E-10	6.58E-12	1.86E-13
¹⁰³ Pd		2.13E-10	4.24E-10	9.37E-13	1.15E-15
^{103m} Rh	.99974	3.14E-12	1.38E-12	1.08E-13	1.13E-16
¹⁰⁷ Pd		4.04E-11	3.45E-09	0.00E+00	0.00E+00
¹⁰⁹ Pd		5.87E-10	2.96E-10	9.69E-13	8.38E-15
^{110m} Ag		2.92E-09	2.17E-08	2.29E-10	6.85E-12
¹¹⁰ Ag	0.0133	0.00E+00	0.00E+00	3.30E-12	9.25E-14
¹¹¹ Ag		1.37E-09	1.66E-09	2.31E-12	6.45E-14
¹⁰⁹ Cd		3.55E-09	3.09E-08	1.94E-12	6.80E-15
^{113m} Cd		4.35E-08	4.13E-07	2.27E-14	2.95E-16
^{115m} Cd		4.37E-09	1.95E-08	2.02E-12	5.88E-14
¹¹⁵ Cd		1.54E-09	1.14E-09	1.99E-11	5.71E-13

Table E.2 Internal committed effective dose equivalent and external effective dose equivalent factors (Continued)

Radio-nuclide	Implicit progeny fraction	Ingestion (Sv/Bq)	Inhalation (Sv/Bq)	External	
				Surface (Sv/d per Bq/m ²)	15 cm* (Sv/d per Bq/m ³)
115mIn	1.0000	9.33E-11	3.59E-11	1.36E-11	3.69E-13
111In		3.59E-10	2.27E-10	3.37E-11	8.73E-13
114mIn		4.61E-09	2.40E-08	7.90E-12	2.05E-13
114In	0.9570	0.00E+00	0.00E+00	2.33E-13	6.85E-15
115mIn		9.33E-11	3.59E-11	1.36E-11	3.69E-13
117mSn		7.97E-10	1.17E-09	1.31E-11	2.97E-13
119mSn		3.76E-10	1.69E-09	9.01E-13	1.39E-15
121mSn		4.19E-10	3.11E-09	4.22E-13	9.11E-16
121Sn		2.44E-10	1.38E-10	9.07E-15	9.02E-17
123Sn		2.27E-09	8.79E-09	7.22E-13	2.02E-14
125Sn		3.33E-09	4.18E-09	2.60E-11	7.88E-13
126Sn		5.27E-09	2.69E-08	4.72E-12	6.82E-14
126mSb	1.0000	2.54E-11	9.17E-12	1.31E-10	3.83E-12
124Sb		2.74E-09	6.80E-09	1.48E-10	4.54E-12
125Sb		7.59E-10	3.30E-09	3.67E-11	1.02E-12
126mSb		2.54E-11	9.17E-12	1.31E-10	3.83E-12
126Sb		2.89E-09	3.17E-09	2.40E-10	7.02E-12
127Sb		1.95E-09	1.63E-09	5.84E-11	1.70E-12
123mTe		1.53E-09	2.86E-09	1.23E-11	2.84E-13
125mTe		9.92E-10	1.97E-09	3.12E-12	7.00E-15
127mTe		2.23E-09	5.81E-09	9.73E-13	2.49E-15
127Te		1.87E-10	8.60E-11	4.47E-13	1.22E-14
129mTe		2.89E-09	6.47E-09	3.27E-12	7.58E-14
129Te	0.6500	5.45E-11	2.42E-11	5.19E-12	1.38E-13
129Te		5.45E-11	2.42E-11	5.19E-12	1.38E-13
131mTe		2.46E-09	1.73E-09	1.18E-10	3.50E-12
131Te	0.2220	2.44E-10	1.29E-10	3.54E-11	9.94E-13
131Te		2.44E-10	1.29E-10	3.54E-11	9.94E-13
132Te		2.54E-09	2.55E-09	1.97E-11	4.80E-13
132I	1.0000	1.82E-10	1.03E-10	1.91E-10	5.67E-12
133mTe		2.26E-10	1.17E-10	1.92E-10	5.72E-12
133Te	0.1300	4.73E-11	2.49E-11	7.72E-11	2.30E-12
133Te		4.73E-11	2.49E-11	7.72E-11	2.30E-12
134Te		6.63E-11	3.44E-11	7.48E-11	2.12E-12
134I	1.0000	6.66E-11	3.55E-11	2.18E-10	6.53E-12
125I		1.04E-08	6.53E-09	3.69E-12	7.65E-15
129I		7.46E-08	4.69E-08	2.23E-12	5.98E-15
130I		1.28E-09	7.14E-10	1.81E-10	5.30E-12
131I		1.44E-08	8.89E-09	3.24E-11	9.21E-13
132I		1.82E-10	1.03E-10	1.91E-10	5.67E-12
133I		2.80E-09	1.58E-09	5.15E-11	1.50E-12
134I		6.66E-11	3.55E-11	2.18E-10	6.53E-12

Table E.2 Internal committed effective dose equivalent and external effective dose equivalent factors (Continued)

Radio-nuclide	Implicit progeny fraction	Ingestion (Sv/Bq)	Inhalation (Sv/Bq)	External	
				Surface (Sv/d per Bq/m ²)	15 cm* (Sv/d per Bq/m ³)
¹³⁵ I		6.08E-10	3.32E-10	1.27E-10	3.94E-12
^{135m} Xe	0.1540	0.00E+00	0.00E+00	3.66E-11	1.05E-12
^{134m} Cs		1.33E-11	1.18E-11	2.24E-12	3.33E-14
¹³⁴ Cs		1.98E-08	1.25E-08	1.31E-10	3.86E-12
¹³⁵ Cs		1.91E-09	1.23E-09	2.87E-15	1.77E-17
¹³⁶ Cs		3.04E-09	1.98E-09	1.80E-10	5.33E-12
¹³⁷ Cs		1.35E-08	8.63E-09	2.46E-14	3.40E-16
^{137m} Ba	0.9460	0.00E+00	0.00E+00	5.06E-11	1.48E-12
¹³⁸ Cs		5.25E-11	2.74E-11	1.89E-10	5.90E-12
¹³⁹ Ba		1.08E-10	4.64E-11	3.96E-12	9.91E-14
¹⁴⁰ Ba		2.56E-09	1.01E-09	1.56E-11	4.34E-13
¹⁴¹ Ba		5.65E-11	2.18E-11	7.04E-11	2.06E-12
¹⁴² Ba		3.01E-11	1.11E-11	8.68E-11	2.56E-12
¹⁴⁰ La		2.28E-09	1.31E-09	1.86E-10	5.78E-12
¹⁴¹ La		3.74E-10	1.57E-10	3.92E-12	1.18E-13
¹⁴² La		1.79E-10	6.84E-11	2.12E-10	6.85E-12
¹⁴¹ Ce		7.83E-10	2.42E-09	6.37E-12	1.45E-13
¹⁴³ Ce		1.23E-09	9.16E-10	2.41E-11	6.28E-13
¹⁴⁴ Ce		5.68E-09	1.01E-07	1.75E-12	3.28E-14
^{144m} Pr	0.0178	0.00E+00	0.00E+00	1.13E-12	6.33E-15
¹⁴⁴ Pr	1.0000	3.15E-11	1.17E-11	3.27E-12	9.71E-14
¹⁴³ Pr		1.27E-09	2.19E-09	6.05E-14	9.90E-16
¹⁴⁴ Pr		3.15E-11	1.17E-11	3.27E-12	9.71E-14
¹⁴⁷ Nd		1.18E-09	1.85E-09	1.20E-11	2.84E-13
¹⁴⁷ Pm		2.83E-10	1.06E-08	2.94E-15	2.30E-17
^{148m} Pm		2.07E-09	6.10E-09	1.69E-10	4.94E-12
¹⁴⁸ Pm		2.94E-09	2.95E-09	4.73E-11	1.44E-12
¹⁴⁹ Pm		1.07E-09	7.93E-10	9.80E-13	2.68E-14
¹⁵¹ Pm		8.09E-10	4.73E-10	2.72E-11	7.37E-13
¹⁴⁷ Sm		5.01E-08	2.02E-05	0.00E+00	0.00E+00
¹⁵¹ Sm		1.05E-10	8.10E-09	4.34E-16	4.55E-19
¹⁵³ Sm		8.07E-10	5.31E-10	5.37E-12	7.27E-14
¹⁵² Eu		1.75E-09	5.97E-08	9.53E-11	2.78E-12
¹⁵⁴ Eu		2.58E-09	7.73E-08	1.02E-10	3.04E-12
¹⁵⁵ Eu		4.13E-10	1.12E-08	5.10E-12	8.42E-14
¹⁵⁶ Eu		2.48E-09	3.82E-09	1.07E-10	3.30E-12
¹⁵³ Gd		3.17E-10	6.43E-09	9.13E-12	1.13E-13
¹⁶⁰ Tb		1.82E-09	6.75E-09	9.32E-11	2.76E-12
^{166m} Ho		2.18E-09	2.09E-07	1.47E-10	4.23E-12
¹⁸¹ W		9.31E-11	4.09E-11	3.39E-12	3.53E-14
¹⁸⁵ W		5.38E-10	2.03E-10	1.59E-14	1.99E-16
¹⁸⁷ W		7.46E-10	1.67E-10	4.05E-11	1.14E-12

Table E.2 Internal committed effective dose equivalent and external effective dose equivalent factors (Continued)

Radio-nuclide	Implicit progeny fraction	Ingestion (Sv/Bq)	Inhalation (Sv/Bq)	External	
				Surface (Sv/d per Bq/m ²)	15 cm* (Sv/d per Bq/m ³)
¹⁸⁷ Re		2.57E-12	1.47E-11	0.00E+00	0.00E+00
¹⁸⁵ Os		6.11E-10	2.80E-09	6.07E-11	1.71E-12
¹⁹¹ Os		6.23E-10	1.13E-09	6.37E-12	1.11E-13
¹⁹² Ir		1.55E-09	7.61E-09	6.93E-11	1.97E-12
¹⁹⁸ Au		1.14E-09	8.87E-10	3.46E-11	9.86E-13
²⁰³ Hg		3.09E-09	1.98E-09	2.00E-11	5.52E-13
²¹⁰ Pb		1.45E-06	3.67E-06	2.14E-13	1.13E-15
²¹² Pb		1.23E-08	4.56E-08	1.23E-11	3.13E-13
²¹² Bi	1.0000	2.87E-10	5.83E-09	1.54E-11	4.63E-13
²¹² Po	0.6407	0.00E+00	0.00E+00	0.00E+00	0.00E+00
²⁰⁸ Tl	0.3593	0.00E+00	0.00E+00	2.58E-10	8.36E-12
²¹⁰ Bi		1.73E-09	5.29E-08	9.06E-14	1.61E-15
²¹² Bi		2.87E-10	5.83E-09	1.54E-11	4.63E-13
²¹² Po	0.6407	0.00E+00	0.00E+00	0.00E+00	0.00E+00
²⁰⁸ Tl	0.3593	0.00E+00	0.00E+00	2.58E-10	8.36E-12
²¹⁰ Po		5.14E-07	2.54E-06	7.16E-16	2.11E-17
²²² Rn		0.00E+00	0.00E+00	3.41E-14	9.81E-16
²¹⁸ Po	1.0000	0.00E+00	0.00E+00	7.67E-16	2.27E-17
²¹⁴ Pb	1.0000	1.69E-10	2.11E-09	2.10E-11	5.78E-13
²¹⁴ Bi	1.0000	7.64E-11	1.78E-09	1.22E-10	3.77E-12
²¹⁴ Po	0.9998	0.00E+00	0.00E+00	7.02E-15	2.07E-16
²²³ Ra		1.78E-07	2.12E-06	1.11E-11	2.67E-13
²¹⁹ Rn	1.000	0.00E+00	0.00E+00	4.74E-12	1.33E-13
²¹⁵ Po	1.000	0.00E+00	0.00E+00	1.51E-14	4.30E-16
²¹¹ Pb	1.000	1.42E-10	2.35E-09	4.38E-12	1.26E-13
²¹¹ Bi	1.000	0.00E+00	0.00E+00	3.96E-12	1.10E-13
²¹¹ Po	0.0028	0.00E+00	0.00E+00	6.57E-13	1.94E-14
²⁰⁷ Tl	0.9972	0.00E+00	0.00E+00	3.25E-13	8.19E-15
²²⁴ Ra		9.89E-08	8.53E-07	8.26E-13	2.26E-14
²²⁰ Rn	1.000	0.00E+00	0.00E+00	3.29E-14	9.52E-16
²¹⁶ Po	1.000	0.00E+00	0.00E+00	1.43E-15	4.21E-17
²²⁵ Ra		1.04E-07	2.10E-06	1.15E-12	5.09E-15
²²⁶ Ra		3.58E-07	2.32E-06	5.56E-13	1.42E-14
²²⁸ Ra		3.88E-07	1.29E-06	0.00E+00	0.00E+00
²²⁸ Ac	1.0000	5.85E-10	8.33E-08	8.01E-11	2.38E-12
²²⁵ Ac		3.00E-08	2.92E-06	1.37E-12	2.89E-14
²²¹ Fr	1.000	0.00E+00	0.00E+00	2.57E-12	6.82E-14
²¹⁷ At	1.000	0.00E+00	0.00E+00	2.61E-14	7.43E-16
²¹³ Bi	1.000	1.95E-10	4.63E-09	1.14E-11	3.24E-13
²¹³ Po	.9784	0.00E+00	0.00E+00	0.00E+00	0.00E+00
²⁰⁹ Tl	.0216	0.00E+00	0.00E+00	1.64E-10	4.99E-12
²⁰⁹ Pb	1.000	5.75E-11	2.56E-11	2.60E-14	3.52E-16

Table E.2 Internal committed effective dose equivalent and external effective dose equivalent factors (Continued)

Radio-nuclide	Implicit progeny fraction	Ingestion (Sv/Bq)	Inhalation (Sv/Bq)	External	
				Surface (Sv/d per Bq/m ²)	15 cm* (Sv/d per Bq/m ³)
²²⁷ Ac		3.80E-06	1.81E-03	1.36E-14	2.26E-16
²²³ Fr	0.0138	2.33E-09	1.68E-09	4.88E-12	8.74E-14
²²⁸ Ac		5.85E-10	8.33E-08	8.01E-11	2.38E-12
²²⁷ Th		1.03E-08	4.37E-06	8.94E-12	2.29E-13
²²⁸ Th		1.07E-07	9.23E-05	2.03E-13	3.60E-15
²²⁹ Th		9.54E-07	5.80E-04	7.38E-12	1.47E-13
²³⁰ Th		1.48E-07	8.80E-05	6.48E-14	5.52E-16
²³¹ Th		3.65E-10	2.37E-10	1.60E-12	1.68E-14
²³² Th		7.38E-07	4.43E-04	4.76E-14	2.40E-16
²³⁴ Th		3.69E-09	9.47E-09	7.18E-13	1.12E-14
^{234m} Pa	0.9980	0.00E+00	0.00E+00	1.32E-12	3.62E-14
²³⁴ Pa	0.0020	5.84E-10	2.20E-10	1.59E-10	4.65E-12
²³¹ Pa		2.86E-06	3.47E-04	3.52E-12	8.30E-14
²³³ Pa		9.81E-10	2.58E-09	1.69E-11	4.45E-13
²³⁴ Pa		5.84E-10	2.20E-10	1.59E-10	4.65E-12
²³² U		3.54E-07	1.78E-04	8.73E-14	4.12E-16
²³³ U		7.81E-08	3.66E-05	6.18E-14	6.25E-16
²³⁴ U		7.66E-08	3.58E-05	6.46E-14	1.85E-16
²³⁵ U		7.19E-08	3.32E-05	1.28E-11	3.24E-13
²³⁶ U		7.26E-08	3.39E-05	5.61E-14	9.87E-17
²³⁷ U		8.57E-10	9.54E-10	1.15E-11	2.40E-13
²³⁸ U		6.88E-08	3.20E-05	4.76E-14	4.76E-17
²⁴⁰ U		1.20E-09	6.13E-10	3.65E-13	6.58E-16
^{240m} Np	1.0000	0.00E+00	0.00E+00	2.82E-11	8.20E-13
²³⁷ Np		1.20E-06	1.46E-04	2.48E-12	3.59E-14
²³⁸ Np		1.08E-09	1.00E-08	4.57E-11	1.36E-12
²³⁹ Np		8.82E-10	6.78E-10	1.41E-11	3.37E-13
²³⁶ Pu		3.15E-07	3.91E-05	8.47E-14	1.04E-16
²³⁷ Pu		1.20E-10	5.33E-10	4.01E-12	7.47E-14
²³⁸ Pu		8.65E-07	1.06E-04	7.23E-14	6.97E-17
²³⁹ Pu		9.56E-07	1.16E-04	3.17E-14	1.31E-16
²⁴⁰ Pu		9.56E-07	1.16E-04	6.93E-14	6.77E-17
²⁴¹ Pu		1.85E-08	2.23E-06	1.67E-16	2.72E-18
²⁴² Pu		9.08E-07	1.11E-04	5.76E-14	5.91E-17
²⁴³ Pu		9.02E-11	4.44E-11	2.08E-12	3.63E-14
²⁴⁴ Pu		8.97E-07	1.09E-04	4.82E-14	3.49E-17
²⁴¹ Am		9.84E-07	1.20E-04	2.37E-12	2.02E-14
^{242m} Am		9.50E-07	1.15E-04	2.60E-13	7.77E-16
²⁴² Am		3.81E-10	1.58E-08	1.35E-12	2.30E-14
²⁴³ Am		9.79E-07	1.19E-04	4.62E-12	6.57E-14
²⁴² Cm		3.10E-08	4.67E-06	8.25E-14	7.83E-17
²⁴³ Cm		6.79E-07	8.30E-05	1.08E-11	2.61E-13

Table E.2 Internal committed effective dose equivalent and external effective dose equivalent factors (Continued)

Radio-nuclide	Implicit progeny fraction	Ingestion (Sv/Bq)	Inhalation (Sv/Bq)	External	
				Surface (Sv/d per Bq/m ²)	15 cm* (Sv/d per Bq/m ³)
²⁴⁴ Cm		5.45E-07	6.70E-05	7.58E-14	5.82E-17
²⁴⁵ Cm		1.01E-06	1.23E-04	7.51E-12	1.56E-13
²⁴⁶ Cm		1.00E-06	1.22E-04	6.78E-14	5.37E-17
²⁴⁷ Cm		9.24E-07	1.12E-04	2.68E-11	7.59E-13
²⁴³ Pu	1.0000	9.02E-11	4.44E-11	2.08E-12	3.63E-14
²⁴⁸ Cm		3.68E-06	4.47E-04	5.18E-14	4.06E-17
²⁵² Cf		2.93E-07	4.24E-05	6.23E-14	8.11E-17

* Based on a density of $1.625 \times 10^6 \text{ g/m}^3$ (EPA 1992).

Table E.3 Ingestion organ dose equivalent factors for organ set 1

Radio-nuclide	Implicit progeny fraction	Organ name						
		Adrenals (Sv/Bq)	Bld wall (Sv/Bq)	B surface (Sv/Bq)	Brain (Sv/Bq)	Breast (Sv/Bq)	S wall (Sv/Bq)	SI wall
³ H		1.73E-11	1.73E-11	1.73E-11	1.73E-11	1.73E-11	1.73E-11	1.73E-11
¹⁰ Be		2.42E-11	2.42E-11	2.15E-09	2.42E-11	2.42E-11	3.15E-10	7.47E-10
¹⁴ C		5.64E-10	5.64E-10	5.64E-10	5.64E-10	5.64E-10	5.64E-10	5.64E-10
¹⁸ F		9.70E-12	3.23E-12	6.02E-11	7.67E-12	6.36E-12	2.87E-10	6.99E-12
²² Na		4.03E-09	2.83E-09	5.54E-09	2.52E-09	2.58E-09	2.93E-09	2.98E-09
²⁴ Na		3.73E-10	3.01E-10	4.68E-10	2.39E-10	2.71E-10	1.18E-09	3.22E-10
³² P		6.55E-10	6.55E-10	7.87E-09	0.00E+00	6.55E-10	1.45E-09	1.05E-09
³³ P		9.37E-11	9.37E-11	1.32E-09	0.00E+00	9.37E-11	1.82E-10	1.38E-10
³⁵ S		9.53E-12	9.53E-12	9.53E-12	9.53E-12	9.53E-12	6.58E-11	1.36E-10
³⁶ Cl		7.99E-10	7.99E-10	7.99E-10	7.99E-10	7.99E-10	1.11E-09	7.99E-10
⁴⁰ K		5.37E-09	5.00E-09	4.88E-09	4.79E-09	4.89E-09	5.48E-09	5.02E-09
⁴¹ Ca		3.24E-12	2.56E-12	4.01E-09	3.86E-12	3.19E-12	5.53E-12	7.73E-12
⁴⁵ Ca		5.36E-11	5.36E-11	5.23E-09	5.36E-11	5.36E-11	1.43E-10	2.10E-10
⁴⁶ Sc		1.34E-10	6.06E-10	1.39E-10	2.82E-12	2.51E-10	6.83E-10	2.31E-09
⁵¹ Cr		6.76E-12	1.47E-11	7.86E-12	3.28E-12	7.51E-12	1.81E-11	4.68E-11
⁵⁴ Mn		4.13E-10	3.72E-10	5.71E-10	0.00E+00	2.77E-10	4.11E-10	9.85E-10
⁵⁶ Mn		1.76E-11	2.56E-11	1.06E-11	0.00E+00	1.76E-11	9.02E-10	1.05E-09
⁵⁵ Fe		1.06E-10	1.00E-10	1.05E-10	1.03E-10	1.04E-10	1.08E-10	1.16E-10
⁵⁹ Fe		1.02E-09	1.08E-09	6.61E-10	4.65E-10	7.37E-10	1.11E-09	2.09E-09
⁵⁷ Co		1.99E-10	2.05E-10	2.12E-10	0.00E+00	1.58E-10	2.25E-10	3.41E-10
⁵⁸ Co		5.93E-10	6.67E-10	4.07E-10	0.00E+00	4.50E-10	7.01E-10	1.25E-09
⁶⁰ Co		8.74E-09	6.64E-09	4.81E-09	0.00E+00	5.08E-09	5.85E-09	8.18E-09
⁵⁹ Ni		3.70E-11	3.41E-11	3.62E-11	3.56E-11	3.58E-11	4.10E-11	5.11E-11
⁶³ Ni		8.50E-11	8.50E-11	8.50E-11	8.50E-11	8.50E-11	1.05E-10	1.32E-10
⁶⁵ Ni		6.02E-12	8.55E-12	2.89E-12	4.39E-13	5.63E-12	6.18E-10	7.26E-10
⁶⁴ Cu		1.71E-11	2.19E-11	1.39E-11	3.62E-11	1.59E-11	1.73E-10	2.13E-10
⁶⁵ Zn		4.76E-09	4.07E-09	4.50E-09	2.85E-09	3.28E-09	3.39E-09	4.27E-09
^{69m} Zn		4.56E-11	5.90E-11	7.27E-11	3.08E-11	4.42E-11	2.68E-10	4.90E-10
⁶⁹ Zn		4.17E-13	4.17E-13	5.18E-13	4.17E-13	4.17E-13	2.14E-10	1.09E-10
⁷⁶ As		1.13E-10	1.32E-10	1.02E-10	8.98E-11	1.09E-10	1.36E-09	1.66E-09
⁷⁵ Se		2.83E-09	1.59E-09	1.70E-09	9.56E-10	1.45E-09	2.18E-09	2.16E-09
⁷⁹ Se		9.06E-10	9.06E-10	9.06E-10	9.06E-10	9.06E-10	9.70E-10	9.38E-10
⁸² Br		5.62E-10	4.83E-10	3.80E-10	2.84E-10	3.81E-10	8.29E-10	4.98E-10
⁸³ Br		7.38E-12	7.34E-12	7.33E-12	7.31E-12	7.34E-12	2.97E-10	7.38E-12
⁸⁴ Br		8.47E-12	5.86E-12	5.56E-12	4.49E-12	6.62E-12	6.82E-10	8.61E-12
⁸⁶ Rb		2.19E-09	2.17E-09	6.86E-09	2.13E-09	2.14E-09	2.92E-09	2.17E-09
⁸⁸ Rb		3.36E-12	2.55E-12	2.75E-12	2.33E-12	2.82E-12	7.32E-10	3.25E-12
⁸⁹ Rb		4.71E-12	2.62E-12	4.19E-12	1.91E-12	3.38E-12	3.63E-10	4.64E-12
⁸⁵ Sr		3.39E-10	3.00E-10	6.06E-10	0.00E+00	2.53E-10	3.09E-10	6.20E-10
⁸⁹ Sr		2.40E-10	2.40E-10	4.81E-09	0.00E+00	2.40E-10	9.12E-10	1.41E-09

Table E.3 Ingestion organ dose equivalent factors for organ set 1 (Continued)

Radio-nuclide	Implicit progeny fraction	Organ name						
		Adrenals (Sv/Bq)	Bld wall (Sv/Bq)	B surface (Sv/Bq)	Brain (Sv/Bq)	Breast (Sv/Bq)	S wall (Sv/Bq)	SI wall
⁹⁰ Sr		1.51E-09	1.51E-09	4.19E-07	0.00E+00	1.51E-09	1.75E-09	1.98E-09
⁹¹ Sr		2.46E-11	6.88E-11	2.02E-11	0.00E+00	3.57E-11	8.50E-10	1.75E-09
⁹⁰ Y		1.26E-14	1.26E-14	3.67E-13	1.26E-14	1.27E-14	1.07E-09	2.55E-09
^{91m} Y		2.00E-12	2.32E-12	8.71E-13	1.97E-14	1.84E-12	4.92E-11	3.09E-11
⁹¹ Y		3.50E-13	1.23E-12	6.13E-12	1.20E-13	5.54E-13	6.94E-10	1.73E-09
⁹² Y		3.14E-12	5.58E-12	1.75E-12	4.65E-14	3.55E-12	1.42E-09	2.00E-09
⁹³ Y		2.23E-12	6.45E-12	1.73E-12	3.46E-14	3.13E-12	1.28E-09	2.51E-09
⁹³ Zr		2.95E-13	4.61E-14	9.14E-09	0.00E+00	1.97E-13	2.27E-11	5.65E-11
⁹⁵ Zr		6.09E-11	2.43E-10	4.86E-10	0.00E+00	1.05E-10	3.57E-10	1.12E-09
⁹⁷ Zr		4.89E-11	1.76E-10	4.55E-11	0.00E+00	8.12E-11	1.21E-09	3.39E-09
^{97m} Nb	0.9470	Note: Contribution included with parent.						
⁹⁷ Nb	0.0530	3.37E-12	4.33E-12	1.60E-12	0.00E+00	3.30E-12	3.88E-10	2.96E-10
^{93m} Nb		2.52E-12	2.52E-12	5.98E-11	2.50E-12	2.57E-12	3.62E-11	8.83E-11
⁹⁴ Nb		3.41E-10	6.05E-10	7.65E-10	0.00E+00	3.47E-10	7.71E-10	2.24E-09
^{95m} Nb		6.67E-12	2.54E-11	4.31E-11	0.00E+00	1.06E-11	2.15E-10	5.46E-10
⁹⁵ Nb		6.79E-11	2.43E-10	2.94E-10	0.00E+00	1.07E-10	2.80E-10	9.13E-10
^{97m} Nb		6.79E-11	2.43E-10	2.94E-10	0.00E+00	1.07E-10	2.80E-10	9.13E-10
⁹⁷ Nb		3.37E-12	4.33E-12	1.60E-12	0.00E+00	3.30E-12	3.88E-10	2.96E-10
⁹³ Mo		1.31E-10	1.02E-10	1.15E-09	0.00E+00	9.96E-11	1.09E-10	1.06E-10
⁹⁹ Mo		2.54E-11	7.46E-11	6.32E-11	0.00E+00	3.43E-11	5.14E-10	1.25E-09
^{99m} Tc		4.33E-12	4.53E-12	4.06E-12	1.82E-12	3.57E-12	7.17E-11	2.22E-11
⁹⁹ Tc		6.04E-11	6.04E-11	6.04E-11	6.04E-11	6.04E-11	3.39E-09	1.19E-10
¹⁰¹ Tc		5.60E-13	2.86E-13	2.55E-13	9.46E-14	4.06E-13	1.50E-10	2.28E-11
¹⁰³ Ru		1.11E-10	2.21E-10	9.63E-11	5.12E-11	1.20E-10	3.14E-10	8.51E-10
¹⁰⁵ Ru		1.29E-11	2.71E-11	8.89E-12	1.27E-12	1.59E-11	4.97E-10	7.89E-10
¹⁰⁶ Ru		1.46E-09	1.50E-09	1.43E-09	1.39E-09	1.44E-09	3.10E-09	5.53E-09
^{103m} Rh		3.50E-15	3.87E-15	5.29E-15	3.24E-15	8.65E-15	2.56E-11	1.60E-11
¹⁰⁵ Rh		6.36E-12	1.85E-11	6.75E-12	2.74E-12	8.97E-12	1.95E-10	4.43E-10
¹⁰³ Pd		2.97E-13	1.66E-12	2.00E-12	4.51E-14	1.58E-12	3.50E-11	1.55E-10
^{103m} Rh	0.99974	3.50E-15	3.87E-15	5.29E-15	3.24E-15	8.65E-15	2.56E-11	1.60E-11
¹⁰⁷ Pd		9.91E-15	9.91E-15	1.43E-13	9.91E-15	9.91E-15	1.07E-11	2.65E-11
¹⁰⁹ Pd		2.18E-13	9.02E-13	1.02E-12	9.30E-14	6.27E-13	4.84E-10	1.00E-09
^{110m} Ag		1.63E-09	1.05E-09	4.93E-10	1.00E-10	7.51E-10	1.50E-09	3.47E-09
¹¹⁰ Ag	0.0133	Note: Contribution included with parent.						
¹¹¹ Ag		1.10E-11	1.58E-11	9.67E-12	7.33E-12	1.09E-11	4.22E-10	9.85E-10
¹⁰⁹ Cd		5.89E-10	2.94E-10	3.28E-10	2.64E-10	3.10E-10	4.09E-10	5.93E-10
^{113m} Cd		3.44E-09	3.44E-09	3.44E-09	3.44E-09	3.44E-09	3.65E-09	3.94E-09
^{115m} Cd		1.79E-10	1.69E-10	1.64E-10	1.60E-10	1.66E-10	8.70E-10	1.84E-09
¹¹⁵ Cd		3.92E-11	9.57E-11	3.06E-11	8.33E-12	4.44E-11	4.65E-10	1.30E-09
^{115m} In	1.0000	2.51E-12	5.39E-12	2.19E-12	1.14E-13	3.16E-12	1.95E-10	3.04E-10
¹¹¹ In		2.52E-11	1.14E-10	3.73E-11	2.02E-12	4.37E-11	1.59E-10	4.95E-10

Table E.3 Ingestion organ dose equivalent factors for organ set 1 (Continued)

Radio-nuclide	Implicit progeny fraction	Organ name						
		Adrenals (Sv/Bq)	Bld wall (Sv/Bq)	B surface (Sv/Bq)	Brain (Sv/Bq)	Breast (Sv/Bq)	S wall (Sv/Bq)	SI wall
^{114m} In		1.39E-10	1.51E-10	1.81E-09	1.18E-10	1.32E-10	1.15E-09	2.73E-09
¹¹⁴ In	0.9570	Note: Contribution included with parent.						
^{115m} In		2.51E-12	5.39E-12	2.19E-12	1.14E-13	3.16E-12	1.95E-10	3.04E-10
^{117m} Sn		1.16E-11	6.26E-11	4.78E-10	3.58E-12	2.39E-11	2.44E-10	6.60E-10
^{119m} Sn		9.16E-12	1.17E-11	1.82E-10	9.63E-12	1.05E-11	1.06E-10	2.61E-10
^{121m} Sn		2.89E-11	3.02E-11	6.12E-10	2.94E-11	2.95E-11	7.49E-11	1.71E-10
¹²¹ Sn		2.00E-13	2.00E-13	2.51E-11	2.00E-13	2.00E-13	1.29E-10	2.86E-10
¹²³ Sn		3.20E-11	3.34E-11	6.62E-10	3.15E-11	3.22E-11	6.32E-10	1.50E-09
¹²⁵ Sn		2.91E-11	9.36E-11	2.38E-10	1.03E-11	4.41E-11	1.02E-09	2.54E-09
¹²⁶ Sn		8.92E-10	1.06E-09	5.06E-09	7.28E-10	7.96E-10	1.60E-09	4.41E-09
^{126m} Sb	1.0000	2.60E-12	1.82E-12	9.53E-13	3.21E-14	2.06E-12	2.64E-10	7.03E-11
¹²⁴ Sb		1.30E-10	5.91E-10	1.89E-10	1.25E-11	2.30E-10	9.45E-10	2.84E-09
¹²⁵ Sb		9.52E-11	1.85E-10	5.86E-10	4.31E-11	1.00E-10	2.97E-10	7.65E-10
^{126m} Sb		2.60E-12	1.82E-12	9.53E-13	3.21E-14	2.06E-12	2.64E-10	7.03E-11
¹²⁶ Sb		1.89E-10	8.62E-10	2.27E-10	1.06E-11	3.53E-10	1.14E-09	3.63E-09
¹²⁷ Sb		4.14E-11	1.82E-10	5.24E-11	3.24E-12	7.60E-11	5.62E-10	1.63E-09
^{123m} Te		1.29E-10	1.31E-10	2.41E-08	0.00E+00	1.26E-10	2.47E-10	4.90E-10
^{125m} Te		4.29E-11	4.80E-11	1.27E-08	0.00E+00	4.64E-11	1.86E-10	3.76E-10
^{127m} Te		9.75E-11	9.66E-11	2.07E-08	0.00E+00	9.74E-11	2.12E-10	4.34E-10
¹²⁷ Te		2.97E-12	3.17E-12	6.46E-12	0.00E+00	3.00E-12	2.43E-10	3.91E-10
^{129m} Te		1.68E-10	1.75E-10	7.99E-09	0.00E+00	1.66E-10	6.27E-10	1.47E-09
¹²⁹ Te	0.6500	6.07E-13	6.72E-13	5.40E-13	0.00E+00	6.05E-13	3.98E-10	2.74E-10
¹²⁹ Te		1.02E-10	2.46E-10	3.24E-10	4.45E-11	1.35E-10	6.01E-10	1.51E-09
¹³¹ Te	0.2220	4.47E-12	5.27E-12	3.69E-12	2.18E-12	4.96E-12	6.27E-10	5.50E-10
¹³¹ Te		4.47E-12	5.27E-12	3.69E-12	2.18E-12	4.96E-12	6.27E-10	5.50E-10
¹³² Te		4.06E-10	4.22E-10	8.30E-10	2.86E-10	3.50E-10	5.23E-10	8.06E-10
¹³² I	1.0000	3.23E-11	2.44E-11	2.19E-11	0.00E+00	2.52E-11	6.31E-10	3.17E-11
^{133m} Tem		1.26E-11	1.20E-11	6.61E-12	2.71E-12	1.14E-11	6.55E-10	4.10E-10
¹³³ Te		1.61E-12	8.93E-13	7.73E-13	4.89E-13	1.23E-12	2.39E-10	4.21E-11
¹³⁴ Te		1.65E-11	1.57E-11	1.23E-11	9.52E-12	1.37E-11	2.34E-10	1.22E-10
¹³⁴ I	1.0000	1.58E-11	1.04E-11	9.32E-12	0.00E+00	1.17E-11	5.49E-10	1.61E-11
¹²⁵ I		2.52E-11	2.90E-11	6.63E-11	0.00E+00	1.45E-10	6.80E-11	3.06E-11
¹²⁹ I		1.32E-10	1.35E-10	2.17E-10	0.00E+00	3.31E-10	2.19E-10	1.41E-10
¹³⁰ I		7.41E-11	5.85E-11	6.12E-11	0.00E+00	7.32E-11	5.82E-10	6.86E-11
¹³¹ I		5.62E-11	4.08E-11	8.72E-11	0.00E+00	1.21E-10	3.06E-10	4.47E-11
¹³² I		3.23E-11	2.44E-11	2.19E-11	0.00E+00	2.52E-11	6.31E-10	3.17E-11
¹³³ I		4.37E-11	3.69E-11	4.07E-11	0.00E+00	4.68E-11	5.54E-10	4.03E-11
¹³⁴ I		1.58E-11	1.04E-11	9.32E-12	0.00E+00	1.17E-11	5.49E-10	1.61E-11
¹³⁵ I		4.84E-11	3.56E-11	3.36E-11	0.00E+00	3.85E-11	5.41E-10	4.11E-11
^{135m} Xe	0.1540	Note: Contribution included with parent.						
^{134m} Cs		7.32E-12	6.96E-12	6.57E-12	0.00E+00	6.28E-12	1.15E-10	7.21E-12
¹³⁴ Cs		2.32E-08	2.14E-08	1.74E-08	0.00E+00	1.72E-08	2.01E-08	2.18E-08

Table E.3 Ingestion organ dose equivalent factors for organ set 1 (Continued)

Radio-nuclide	Implicit progeny fraction	Organ name						
		Adrenals (Sv/Bq)	Bld wall (Sv/Bq)	B surface (Sv/Bq)	Brain (Sv/Bq)	Breast (Sv/Bq)	S wall (Sv/Bq)	SI wall
¹³⁵ Cs		1.91E-09	1.91E-09	1.91E-09	0.00E+00	1.91E-09	1.99E-09	1.91E-09
¹³⁶ Cs		3.47E-09	3.46E-09	2.71E-09	0.00E+00	2.65E-09	3.38E-09	3.42E-09
¹³⁷ Cs		1.50E-08	1.41E-08	1.26E-08	0.00E+00	1.24E-08	1.39E-08	1.44E-08
^{137m} Ba	0.9460	Note: Contribution included with parent.						
¹³⁸ Cs		1.22E-11	6.83E-12	6.47E-12	0.00E+00	8.00E-12	7.01E-10	1.06E-11
¹³⁹ Ba		5.41E-13	5.75E-13	4.38E-13	2.59E-13	5.17E-13	6.90E-10	5.55E-10
¹⁴⁰ Ba		1.20E-10	3.71E-10	5.53E-10	5.67E-11	1.59E-10	5.83E-10	1.70E-09
¹⁴¹ Ba		1.70E-12	1.03E-12	1.27E-12	1.52E-13	1.22E-12	3.94E-10	1.86E-10
¹⁴² Ba		3.01E-12	2.95E-12	1.24E-12	1.17E-13	2.52E-12	2.02E-10	1.11E-10
¹⁴⁰ La		1.05E-10	4.50E-10	9.77E-11	2.03E-12	1.80E-10	1.09E-09	2.96E-09
¹⁴¹ La		6.36E-13	1.27E-12	6.06E-13	2.82E-14	7.07E-13	9.33E-10	1.37E-09
¹⁴² La		1.71E-11	2.06E-11	7.40E-12	3.36E-13	1.54E-11	8.53E-10	7.76E-10
¹⁴¹ Ce		4.55E-12	3.29E-11	2.30E-11	0.00E+00	1.11E-11	2.23E-10	5.88E-10
¹⁴³ Ce		1.18E-11	5.57E-11	1.61E-11	0.00E+00	2.32E-11	5.61E-10	1.37E-09
¹⁴⁴ Ce		8.91E-12	2.43E-11	1.28E-10	0.00E+00	1.22E-11	1.11E-09	3.71E-09
^{144m} Pr	0.0178	Note: Contribution included with parent.						
¹⁴⁴ Pr	1.0000	5.20E-14	2.64E-14	1.52E-14	9.97E-16	3.38E-14	4.09E-10	9.63E-11
¹⁴³ Pr		5.60E-19	2.65E-18	1.03E-12	7.35E-21	1.09E-18	3.61E-10	8.95E-10
¹⁴⁴ Pr		5.20E-14	2.64E-14	1.52E-14	9.97E-16	3.38E-14	4.09E-10	9.63E-11
¹⁴⁷ Nd		7.69E-12	4.96E-11	2.22E-11	8.19E-14	1.87E-11	3.58E-10	9.43E-10
¹⁴⁷ Pm		4.23E-16	2.05E-15	2.61E-10	5.78E-17	7.45E-16	7.14E-11	1.78E-10
^{148m} Pm		1.32E-10	6.45E-10	1.74E-10	2.80E-12	2.59E-10	7.89E-10	2.59E-09
¹⁴⁸ Pm		3.28E-11	1.58E-10	3.49E-11	6.04E-13	6.11E-11	9.71E-10	2.53E-09
¹⁴⁹ Pm		5.35E-13	2.62E-12	9.59E-13	3.82E-15	1.02E-12	4.19E-10	9.97E-10
¹⁵¹ Pm		1.30E-11	5.84E-11	1.62E-11	9.72E-14	2.42E-11	4.19E-10	1.02E-09
¹⁴⁷ Sm		0.00E+00	0.00E+00	8.59E-07	0.00E+00	0.00E+00	5.18E-10	1.29E-09
¹⁵¹ Sm		1.16E-15	8.66E-16	3.45E-10	3.14E-16	1.03E-15	2.28E-11	5.70E-11
¹⁵³ Sm		2.21E-12	1.83E-11	8.38E-12	5.28E-15	6.91E-12	3.32E-10	8.10E-10
¹⁵² Eu		4.78E-10	4.29E-10	2.09E-09	1.20E-10	2.85E-10	6.42E-10	1.75E-09
¹⁵⁴ Eu		4.37E-10	4.42E-10	4.46E-09	1.06E-10	2.79E-10	8.19E-10	2.23E-09
¹⁵⁵ Eu		1.60E-11	3.07E-11	1.29E-09	3.78E-12	1.44E-11	1.03E-10	2.80E-10
¹⁵⁶ Eu		8.30E-11	3.85E-10	1.16E-10	2.09E-12	1.52E-10	8.32E-10	2.40E-09
¹⁵³ Gd		5.80E-12	5.07E-11	7.92E-11	4.50E-13	1.80E-11	9.86E-11	3.18E-10
¹⁶⁰ Tb		7.62E-11	3.52E-10	1.57E-10	2.45E-12	1.43E-10	6.12E-10	1.88E-09
^{166m} Ho		4.74E-10	6.25E-10	2.35E-09	9.46E-11	3.48E-10	8.98E-10	2.38E-09
¹⁸¹ W		2.08E-12	2.00E-11	1.03E-11	1.19E-13	7.01E-12	3.08E-11	1.03E-10
¹⁸⁵ W		3.14E-15	2.67E-14	4.90E-12	1.06E-16	8.98E-15	1.46E-10	3.61E-10
¹⁸⁷ W		1.80E-11	7.31E-11	2.12E-11	1.87E-13	3.22E-11	4.29E-10	1.03E-09
¹⁸⁷ Re		3.94E-13	3.94E-13	3.94E-13	3.94E-13	3.94E-13	2.21E-11	7.74E-13
¹⁸⁵ Os		1.15E-10	2.69E-10	8.91E-11	0.00E+00	1.25E-10	2.85E-10	8.78E-10
¹⁹¹ Os		8.38E-12	3.78E-11	1.72E-11	0.00E+00	1.51E-11	1.90E-10	5.01E-10
¹⁹² Ir		1.34E-10	3.36E-10	1.11E-10	0.00E+00	1.51E-10	5.62E-10	1.57E-09

Table E.3 Ingestion organ dose equivalent factors for organ set 1 (Continued)

Radio-nuclide	Implicit progeny fraction	Organ name						
		Adrenals (Sv/Bq)	Bld wall (Sv/Bq)	B surface (Sv/Bq)	Brain (Sv/Bq)	Breast (Sv/Bq)	S wall (Sv/Bq)	SI wall
¹⁹⁸ Au		3.98E-11	1.84E-10	4.06E-11	1.67E-11	5.51E-11	4.94E-10	1.15E-09
²⁰³ Hg		1.79E-09	1.32E-09	1.51E-09	1.16E-08	1.23E-09	1.61E-09	1.50E-09
²¹⁰ Pb		1.25E-07	1.25E-07	2.16E-05	0.00E+00	1.25E-07	1.25E-07	1.25E-07
²¹² Pb		1.66E-09	1.71E-09	1.66E-07	0.00E+00	1.67E-09	2.93E-09	5.76E-09
²¹² Bi	1.0000	1.27E-11	1.29E-11	9.14E-12	0.00E+00	1.18E-11	1.60E-09	1.08E-09
²¹² Po	0.6407	Note: Contribution included with parent.						
²⁰⁸ Tl	0.3593	Note: Contribution included with parent.						
²¹⁰ Bi		1.97E-11	1.97E-11	1.97E-11	0.00E+00	1.97E-11	4.65E-10	1.06E-09
²¹² Bi		1.27E-11	1.29E-11	9.14E-12	0.00E+00	1.18E-11	1.60E-09	1.08E-09
²¹² Po	0.6407	Note: Contribution included with parent.						
²⁰⁸ Tl	0.3593	Note: Contribution included with parent.						
²¹⁰ Po		8.23E-08	8.23E-08	8.23E-08	0.00E+00	8.23E-08	8.36E-08	8.51E-08
²²² Rn		8.23E-08	8.23E-08	8.23E-08	0.00E+00	8.23E-08	8.36E-08	8.51E-08
²¹⁸ Po	1.0000	Note: Contribution included with parent.						
²¹⁴ Po ^b	1.0000	2.50E-11	2.47E-11	1.10E-09	0.00E+00	2.42E-11	8.75E-10	5.62E-10
²¹⁴ Bi	1.0000	3.61E-12	2.25E-12	1.51E-12	0.00E+00	2.55E-12	8.65E-10	2.32E-10
²¹⁴ Po	0.9998	Note: Contribution included with parent.						
²²³ Ra		4.23E-08	4.24E-08	2.93E-06	0.00E+00	4.23E-08	4.83E-08	5.64E-08
²¹⁹ Rn	1.000	Note: Contribution included with parent.						
²¹⁵ Po	1.000	Note: Contribution included with parent.						
²¹¹ Pb	1.000	1.91E-11	1.91E-11	1.60E-10	0.00E+00	1.91E-11	1.17E-09	5.74E-10
²¹¹ Bi	1.000	Note: Contribution included with parent.						
²¹¹ Po	0.0028	Note: Contribution included with parent.						
²⁰⁷ Tl	0.9972	Note: Contribution included with parent.						
²²⁴ Ra		2.06E-08	2.08E-08	1.59E-06	0.00E+00	2.06E-08	2.49E-08	3.03E-08
²²⁰ Rn	1.000	Note: Contribution included with parent.						
²¹⁶ Po	1.000	Note: Contribution included with parent.						
²²⁵ Ra		3.37E-08	3.37E-08	1.78E-06	0.00E+00	3.37E-08	3.38E-08	3.41E-08
²²⁶ Ra		9.19E-08	9.15E-08	6.83E-06	0.00E+00	9.17E-08	9.25E-08	9.37E-08
²²⁸ Ra		1.58E-07	1.57E-07	5.82E-06	0.00E+00	1.57E-07	1.57E-07	1.58E-07
²²⁸ Ac	1.0000	1.80E-11	4.09E-11	3.01E-09	2.54E-13	2.31E-11	6.21E-10	1.12E-09
²²⁵ Ac		1.30E-11	7.45E-11	9.94E-08	2.44E-13	2.73E-11	5.23E-09	1.67E-08
²²¹ Fr	1.000	Note: Contribution included with parent.						
²¹⁷ At	1.000	Note: Contribution included with parent.						
²¹³ Bi	1.000	4.86E-12	4.84E-12	4.45E-12	0.00E+00	4.73E-12	1.31E-09	7.46E-10
²¹³ Po	0.9784	Note: Contribution included with parent.						
²⁰⁹ Tl	0.0216	Note: Contribution included with parent.						
²⁰⁹ Pb	1.000	5.37E-13	5.37E-13	2.09E-11	0.00E+00	5.37E-13	1.88E-10	2.24E-10
²²⁷ Ac		3.89E-10	5.33E-11	6.73E-05	1.31E-10	1.41E-10	1.96E-10	2.90E-10
²²³ Fr	0.0138	2.32E-09	2.32E-09	2.32E-09	5.44E-12	2.32E-09	2.49E-09	2.32E-09
²²⁸ Ac		1.80E-11	4.09E-11	3.01E-09	2.54E-13	2.31E-11	6.21E-10	1.12E-09
²²⁷ Th		1.30E-10	1.73E-10	6.84E-08	0.00E+00	1.40E-10	1.63E-09	4.09E-09

Table E.3 Ingestion organ dose equivalent factors for organ set 1 (Continued)

Radio-nuclide	Implicit progeny fraction	Organ name						
		Adrenals (Sv/Bq)	Bld wall (Sv/Bq)	B surface (Sv/Bq)	Brain (Sv/Bq)	Breast (Sv/Bq)	S wall (Sv/Bq)	SI wall
²²⁸ Th		2.32E-09	2.38E-09	2.37E-06	0.00E+00	2.33E-09	3.64E-09	6.07E-09
²²⁹ Th		4.57E-09	4.59E-09	2.38E-05	0.00E+00	4.57E-09	5.84E-09	7.84E-09
²³⁰ Th		6.80E-10	6.80E-10	3.60E-06	0.00E+00	6.80E-10	1.77E-09	3.41E-09
²³¹ Th		3.93E-13	2.89E-12	3.17E-12	0.00E+00	1.44E-12	1.95E-10	4.54E-10
²³² Th		1.31E-09	1.21E-09	1.85E-05	0.00E+00	1.26E-09	2.14E-09	3.56E-09
²³⁴ Th		1.64E-12	9.15E-12	2.08E-11	0.00E+00	3.57E-12	9.95E-10	2.55E-09
^{234m} Pa	0.9980	Note: Contribution included with parent.						
²³⁴ Pa	0.0020	3.72E-11	9.06E-11	2.74E-11	4.48E-13	4.99E-11	7.80E-10	1.48E-09
²³¹ Pa		9.83E-11	5.06E-11	7.22E-05	1.28E-10	7.81E-11	1.25E-09	3.11E-09
²³³ Pa		1.25E-11	7.58E-11	1.02E-10	3.41E-13	2.71E-11	2.92E-10	8.02E-10
²³⁴ Pa		3.72E-11	9.06E-11	2.74E-11	4.48E-13	4.99E-11	7.80E-10	1.48E-09
²³² U		8.49E-09	8.15E-09	6.63E-06	0.00E+00	8.33E-09	9.38E-09	1.12E-08
²³³ U		2.62E-09	2.62E-09	1.16E-06	0.00E+00	2.62E-09	3.74E-09	5.28E-09
²³⁴ U		2.58E-09	2.58E-09	1.13E-06	0.00E+00	2.58E-09	3.70E-09	5.23E-09
²³⁵ U		2.50E-09	2.49E-09	1.05E-06	0.00E+00	2.49E-09	3.56E-09	5.24E-09
²³⁶ U		2.45E-09	2.45E-09	1.07E-06	0.00E+00	2.45E-09	3.50E-09	4.95E-09
²³⁷ U		7.28E-12	5.18E-11	3.39E-11	0.00E+00	1.81E-11	2.75E-10	7.34E-10
²³⁸ U		2.31E-09	2.30E-09	1.01E-06	0.00E+00	2.31E-09	3.28E-09	4.65E-09
²⁴⁰ U		9.90E-12	3.39E-11	1.02E-11	0.00E+00	1.60E-11	8.34E-10	2.03E-09
^{240m} Np	1.0000	Note: Contribution included with parent.						
²³⁷ Np		2.28E-10	8.39E-11	2.72E-05	2.11E-10	1.45E-10	1.29E-09	3.13E-09
²³⁸ Np		2.77E-11	1.06E-10	1.77E-09	4.71E-13	4.81E-11	4.28E-10	1.13E-09
²³⁹ Np		7.91E-12	4.74E-11	3.59E-11	7.93E-14	1.72E-11	3.46E-10	8.76E-10
²³⁶ Pu		5.96E-13	2.65E-13	5.61E-08	2.80E-13	3.90E-13	1.34E-09	3.36E-09
²³⁷ Pu		2.44E-12	2.11E-11	7.40E-12	5.98E-15	7.07E-12	3.80E-11	1.22E-10
²³⁸ Pu		8.97E-14	1.54E-13	1.58E-07	8.34E-14	1.80E-13	1.28E-09	3.20E-09
²³⁹ Pu		8.28E-14	1.25E-13	1.76E-07	7.66E-14	1.21E-13	1.19E-09	2.99E-09
²⁴⁰ Pu		8.63E-14	1.50E-13	1.76E-07	7.91E-14	1.73E-13	1.20E-09	3.00E-09
²⁴¹ Pu		6.58E-15	1.43E-15	3.48E-09	2.82E-15	2.79E-15	6.07E-12	1.52E-11
²⁴² Pu		1.25E-13	3.84E-13	1.67E-07	7.88E-14	2.54E-13	1.14E-09	2.85E-09
²⁴³ Pu		3.57E-13	1.03E-12	5.71E-13	8.11E-16	5.93E-13	1.79E-10	2.88E-10
²⁴⁴ Pu		2.63E-11	1.37E-10	1.65E-07	3.03E-12	5.36E-11	1.26E-09	3.69E-09
²⁴¹ Am		4.62E-11	2.29E-11	1.81E-05	2.25E-11	2.62E-11	1.34E-09	3.34E-09
^{242m} Am		2.59E-11	7.92E-12	1.76E-05	1.04E-11	1.22E-11	7.88E-11	2.72E-10
²⁴² Am		4.10E-13	2.08E-12	1.52E-09	2.13E-14	9.38E-13	2.04E-10	4.41E-10
²⁴³ Am		3.04E-10	9.91E-11	1.80E-05	1.26E-10	1.41E-10	1.40E-09	3.40E-09
²⁴² Cm		8.86E-12	8.92E-12	4.46E-07	8.83E-12	8.95E-12	1.43E-09	3.55E-09
²⁴³ Cm		1.26E-10	7.72E-11	1.23E-05	5.03E-11	6.96E-11	1.59E-09	3.96E-09
²⁴⁴ Cm		9.15E-12	8.58E-12	9.77E-06	8.69E-12	8.82E-12	1.35E-09	3.37E-09
²⁴⁵ Cm		1.23E-10	6.52E-11	1.86E-05	5.34E-11	6.80E-11	1.40E-09	3.46E-09
²⁴⁶ Cm		6.55E-11	3.07E-11	1.85E-05	3.35E-11	3.91E-11	1.30E-09	3.23E-09
²⁴⁷ Cm		4.90E-10	2.07E-10	1.70E-05	1.94E-10	2.29E-10	1.47E-09	3.66E-09

Table E.3 Ingestion organ dose equivalent factors for organ set 1 (Continued)

Radio-nuclide	Implicit progeny fraction	Organ name						
		Adrenals (Sv/Bq)	Bld wall (Sv/Bq)	B surface (Sv/Bq)	Brain (Sv/Bq)	Breast (Sv/Bq)	S wall (Sv/Bq)	SI wall
²⁴³ Pu	1.0000	3.57E-13	1.03E-12	5.71E-13	8.11E-16	5.93E-13	1.79E-10	2.88E-10
²⁴⁸ Cm		2.02E-08	8.13E-09	6.75E-05	9.01E-09	1.10E-08	1.73E-08	3.89E-08
²⁵² Cf		1.22E-09	2.68E-09	5.84E-06	6.09E-10	1.49E-09	5.49E-09	1.63E-08

Table E.4 Ingestion organ dose equivalent factors for organ set 2

Radio-nuclide	Implicit progeny fraction	Organ name (Sv/Bq)						
		ULI wall	LLI wall	Kidneys	Liver	Lungs	Ovaries	Pancreas
³ H		1.73E-11	1.73E-11	1.73E-11	1.73E-11	1.73E-11	1.73E-11	1.73E-11
¹⁰ Be		4.30E-09	1.29E-08	2.42E-11	2.42E-11	2.42E-11	2.42E-11	2.42E-11
¹⁴ C		5.64E-10	5.64E-10	5.64E-10	5.64E-10	5.64E-10	5.64E-10	5.64E-10
¹⁸ F		7.54E-12	5.52E-12	8.36E-12	5.74E-12	6.54E-12	4.97E-12	2.91E-11
²² Na		2.86E-09	3.08E-09	2.84E-09	2.70E-09	2.51E-09	2.81E-09	2.83E-09
²⁴ Na		3.10E-10	3.39E-10	2.98E-10	2.93E-10	2.60E-10	3.43E-10	4.37E-10
³² P		2.95E-09	7.24E-09	6.55E-10	6.55E-10	6.55E-10	6.55E-10	6.55E-10
³³ P		3.50E-10	8.45E-10	9.37E-11	9.37E-11	9.37E-11	9.37E-11	9.37E-11
³⁵ S		7.53E-10	2.23E-09	9.53E-12	9.53E-12	9.53E-12	9.53E-12	9.53E-12
³⁶ Cl		7.99E-10	7.99E-10	7.99E-10	7.99E-10	7.99E-10	7.99E-10	7.99E-10
⁴⁰ K		4.97E-09	5.02E-09	4.93E-09	4.95E-09	4.85E-09	5.07E-09	4.93E-09
⁴¹ Ca		3.19E-11	8.82E-11	3.06E-12	2.78E-12	2.84E-12	2.71E-12	3.21E-12
⁴⁵ Ca		9.94E-10	2.80E-09	5.36E-11	5.36E-11	5.36E-11	5.36E-11	5.36E-11
⁴⁶ Sc		4.66E-09	1.04E-08	2.84E-10	2.02E-10	4.86E-11	2.01E-09	2.60E-10
⁵¹ Cr		1.06E-10	2.48E-10	8.48E-12	7.01E-12	4.38E-12	4.00E-11	8.96E-12
⁵⁴ Mn		1.35E-09	2.20E-09	3.82E-10	1.00E-09	2.29E-10	9.48E-10	3.81E-10
⁵⁶ Mn		1.37E-09	5.40E-10	3.20E-11	2.63E-11	8.80E-12	8.53E-11	5.62E-11
⁵⁵ Fe		1.72E-10	3.04E-10	1.03E-10	3.44E-10	1.02E-10	1.07E-10	1.04E-10
⁵⁹ Fe		3.94E-09	8.43E-09	9.09E-10	1.54E-09	6.35E-10	1.66E-09	9.03E-10
⁵⁷ Co		5.61E-10	1.08E-09	1.97E-10	4.65E-10	1.63E-10	2.94E-10	2.17E-10
⁵⁸ Co		1.86E-09	3.33E-09	5.74E-10	1.01E-09	4.05E-10	1.08E-09	5.65E-10
⁶⁰ Co		9.58E-09	1.35E-08	6.41E-09	1.28E-08	4.96E-09	7.23E-09	6.23E-09
⁵⁹ Ni		1.16E-10	2.70E-10	3.56E-11	3.58E-11	3.50E-11	3.83E-11	3.61E-11
⁶³ Ni		3.62E-10	9.18E-10	8.52E-11	8.50E-11	8.50E-11	8.50E-11	8.50E-11
⁶⁵ Ni		9.34E-10	3.65E-10	1.06E-11	7.27E-12	2.75E-12	2.43E-11	1.80E-11
⁶⁴ Cu		6.07E-10	7.51E-10	1.95E-11	3.71E-11	1.28E-11	4.78E-11	4.27E-11
⁶⁵ Zn		4.23E-09	4.97E-09	3.87E-09	3.68E-09	3.08E-09	3.51E-09	3.56E-09
^{69m} Zn		1.77E-09	2.39E-09	5.16E-11	4.63E-11	3.63E-11	1.23E-10	5.92E-11
⁶⁹ Zn	0.9997	6.16E-11	1.04E-11	4.17E-13	4.17E-13	4.17E-13	4.17E-13	4.17E-13
⁶⁹ Zn		6.16E-11	1.04E-11	4.17E-13	4.17E-13	4.17E-13	4.17E-13	4.17E-13
⁷⁶ As		6.55E-09	1.18E-08	3.83E-10	3.19E-10	9.83E-11	2.16E-10	1.25E-10
⁷⁵ Se		2.24E-09	1.97E-09	7.17E-09	5.73E-09	1.66E-09	1.80E-09	4.00E-09
⁷⁹ Se		1.10E-09	1.48E-09	1.25E-08	6.48E-09	9.06E-10	9.06E-10	3.89E-09
⁸² Br		4.85E-10	4.95E-10	4.58E-10	4.52E-10	3.84E-10	4.14E-10	5.05E-10
⁸³ Br		7.38E-12	7.36E-12	7.37E-12	7.36E-12	7.35E-12	7.35E-12	7.54E-12
^{83m} Kr	1.0000	Note: Contribution included with parent.						
⁸⁴ Br		9.16E-12	7.10E-12	9.10E-12	7.70E-12	6.99E-12	6.75E-12	2.54E-11
⁸⁶ Rb		2.16E-09	2.17E-09	2.16E-09	2.16E-09	2.14E-09	2.14E-09	2.15E-09
⁸⁸ Rb		3.43E-12	2.91E-12	3.41E-12	3.06E-12	2.91E-12	2.78E-12	7.56E-12
⁸⁹ Rb		5.17E-12	3.56E-12	5.21E-12	4.07E-12	3.68E-12	3.32E-12	1.77E-11
⁸⁵ Sr		8.69E-10	1.50E-09	2.54E-10	2.17E-10	2.06E-10	6.25E-10	2.53E-10

Table E.4 Ingestion organ dose equivalent factors for organ set 2 (Continued)

Radio-nuclide	Implicit progeny fraction	Organ name (Sv/Bq)						
		ULI wall	LLI wall	Kidneys	Liver	Lungs	Ovaries	Pancreas
⁸⁹ Sr		7.30E-09	2.07E-08	2.40E-10	2.40E-10	2.40E-10	2.40E-10	2.40E-10
⁹⁰ Sr		5.74E-09	1.97E-08	1.51E-09	1.51E-09	1.51E-09	1.51E-09	1.51E-09
⁹¹ Sr		4.88E-09	5.11E-09	5.47E-11	3.95E-11	9.81E-12	2.48E-10	5.95E-11
^{91m} Y	0.5780	3.08E-11	2.39E-11	3.92E-12	2.46E-12	1.28E-12	6.94E-12	1.12E-11
⁹⁰ Y		1.32E-08	3.16E-08	1.26E-14	3.65E-13	1.26E-14	1.43E-14	1.26E-14
^{91m} Y		3.08E-11	2.39E-11	3.92E-12	2.46E-12	1.28E-12	6.94E-12	1.12E-11
⁹¹ Y		1.02E-08	3.02E-08	6.10E-13	6.17E-12	2.02E-13	3.54E-12	5.61E-13
⁹² Y		3.31E-09	1.74E-09	6.52E-12	4.53E-12	1.39E-12	1.96E-11	1.00E-11
⁹³ Y		7.80E-09	8.84E-09	4.74E-12	3.52E-12	8.67E-13	2.20E-11	5.67E-12
⁹³ Zr		3.34E-10	1.00E-09	1.09E-13	8.27E-14	1.15E-13	9.23E-14	1.28E-13
⁹⁵ Zr		3.05E-09	7.81E-09	1.13E-10	7.78E-11	2.34E-11	8.16E-10	1.05E-10
⁹⁷ Zr		1.21E-08	1.79E-08	1.10E-10	7.97E-11	1.76E-11	6.22E-10	1.07E-10
⁹⁷ Nb	0.9470	Note: Contribution included with parent.						
⁹⁷ Nb	0.0530	2.20E-10	4.75E-11	6.84E-12	4.36E-12	1.98E-12	1.45E-11	1.66E-11
^{93m} Nb		4.96E-10	1.47E-09	3.44E-11	2.47E-12	2.45E-12	5.77E-12	2.53E-12
⁹⁴ Nb		5.19E-09	1.25E-08	6.95E-10	2.82E-10	1.72E-10	1.80E-09	3.73E-10
^{95m} Nb		2.59E-09	6.47E-09	1.80E-11	8.02E-12	2.82E-12	9.30E-11	1.14E-11
⁹⁵ Nb		1.82E-09	4.00E-09	1.37E-10	8.29E-11	2.74E-11	8.05E-10	1.12E-10
^{97m} Nb		1.82E-09	4.00E-09	1.37E-10	8.29E-11	2.74E-11	8.05E-10	1.12E-10
⁹⁷ Nb		2.20E-10	4.75E-11	6.84E-12	4.36E-12	1.98E-12	1.45E-11	1.66E-11
⁹³ Mo		1.33E-10	1.81E-10	1.65E-09	1.80E-09	1.06E-10	1.27E-10	1.07E-10
⁹⁹ Mo		5.75E-09	1.37E-08	1.77E-10	1.79E-10	1.51E-11	2.18E-10	3.84E-11
^{99m} Tc	0.8760	3.70E-11	2.54E-11	5.19E-12	4.72E-12	3.14E-12	9.75E-12	1.07E-11
^{99m} Tc		3.70E-11	2.54E-11	5.19E-12	4.72E-12	3.14E-12	9.75E-12	1.07E-11
⁹⁹ Tc		4.05E-10	1.10E-09	6.04E-11	8.23E-11	6.04E-11	6.04E-11	6.04E-11
¹⁰¹ Tc		4.95E-12	7.57E-13	8.27E-13	5.37E-13	4.13E-13	6.29E-13	3.24E-12
¹⁰³ Ru		2.53E-09	6.53E-09	1.31E-10	1.12E-10	7.31E-11	5.72E-10	1.28E-10
¹⁰⁵ Ru		1.59E-09	1.34E-09	2.70E-11	1.92E-11	6.21E-12	9.67E-11	3.86E-11
¹⁰⁶ Ru		2.47E-08	7.09E-08	1.45E-09	1.44E-09	1.42E-09	1.64E-09	1.45E-09
¹⁰⁶ Rh	1.0000	Note: Contribution included with parent.						
^{103m} Rh		9.05E-12	1.45E-12	4.76E-15	4.96E-15	4.93E-15	4.02E-14	4.46E-14
¹⁰⁵ Rh		1.89E-09	3.79E-09	1.06E-11	8.37E-12	3.86E-12	5.80E-11	1.12E-11
¹⁰³ Pd		8.30E-10	2.32E-09	2.04E-11	1.13E-11	1.28E-13	4.13E-11	7.75E-13
^{103m} Rh	0.99974	9.05E-12	1.45E-12	4.76E-15	4.96E-15	4.93E-15	4.02E-14	4.46E-14
¹⁰⁷ Pd		1.57E-10	4.72E-10	6.71E-12	3.47E-12	9.91E-15	9.91E-15	9.91E-15
¹⁰⁹ Pd		3.53E-09	4.73E-09	6.76E-12	3.68E-12	1.49E-13	7.90E-12	8.68E-13
^{110m} Ag		5.86E-09	1.08E-08	1.50E-09	8.62E-09	8.30E-10	2.99E-09	1.64E-09
¹¹⁰ Ag	0.0133	Note: Contribution included with parent.						
¹¹¹ Ag		5.40E-09	1.48E-08	1.24E-11	9.20E-10	8.84E-12	3.58E-11	1.27E-11
¹⁰⁹ Cd		1.80E-09	4.62E-09	4.08E-08	7.38E-09	3.17E-10	3.46E-10	3.55E-10
^{113m} Cd		6.43E-09	1.25E-08	5.64E-07	9.72E-08	3.44E-09	3.44E-09	3.44E-09
^{115m} Cd		9.89E-09	2.89E-08	2.58E-08	4.47E-09	1.64E-10	1.84E-10	1.74E-10

Table E.4 Ingestion organ dose equivalent factors for organ set 2 (Continued)

Radio-nuclide	Implicit progeny fraction	Organ name (Sv/Bq)						
		ULI wall	LLI wall	Kidneys	Liver	Lungs	Ovaries	Pancreas
¹¹⁵ Cd		6.30E-09	1.50E-08	9.94E-10	2.07E-10	1.65E-11	3.17E-10	5.29E-11
^{115m} In	1.0000	5.74E-10	3.55E-10	6.04E-12	4.17E-12	1.03E-12	2.20E-11	8.38E-12
¹¹¹ In		1.07E-09	2.01E-09	6.76E-11	4.71E-11	8.35E-12	4.15E-10	5.53E-11
^{114m} In		1.49E-08	4.36E-08	3.97E-09	1.98E-09	1.23E-10	2.49E-10	1.41E-10
¹¹⁴ In	0.9570	Note: Contribution included with parent.						
^{115m} In		5.74E-10	3.55E-10	6.04E-12	4.17E-12	1.03E-12	2.20E-11	8.38E-12
^{117m} Sn		2.90E-09	7.94E-09	2.48E-11	1.77E-11	5.50E-12	2.23E-10	2.61E-11
^{119m} Sn		1.37E-09	4.04E-09	9.34E-12	9.46E-12	9.20E-12	4.11E-11	9.95E-12
^{121m} Sn		1.14E-09	4.47E-09	2.89E-11	2.90E-11	2.90E-11	4.31E-11	2.93E-11
¹²¹ Sn		1.27E-09	2.36E-09	2.00E-13	2.00E-13	2.00E-13	2.00E-13	2.00E-13
¹²³ Sn		8.68E-09	2.59E-08	3.24E-11	3.20E-11	3.15E-11	3.80E-11	3.23E-11
¹²⁵ Sn		1.32E-08	3.67E-08	4.95E-11	3.65E-11	1.60E-11	2.88E-10	4.69E-11
¹²⁶ Sn		1.57E-08	4.33E-08	8.19E-10	6.85E-10	5.99E-10	2.41E-09	7.78E-10
^{126m} Sb	1.0000	2.59E-11	7.59E-12	4.53E-12	2.77E-12	1.88E-12	5.29E-12	1.72E-11
¹²⁴ Sb		8.85E-09	2.33E-08	2.55E-10	2.18E-10	5.40E-11	1.78E-09	2.40E-10
¹²⁵ Sb		2.22E-09	5.79E-09	1.13E-10	2.49E-10	6.03E-11	5.24E-10	1.15E-10
^{126m} Sb		2.59E-11	7.59E-12	4.53E-12	2.77E-12	1.88E-12	5.29E-12	1.72E-11
¹²⁶ Sb		8.48E-09	1.94E-08	3.93E-10	2.99E-10	6.85E-11	2.89E-09	3.71E-10
¹²⁷ Sb		7.31E-09	1.96E-08	8.71E-11	7.35E-11	1.57E-11	6.14E-10	8.40E-11
^{123m} Te		1.67E-09	4.54E-09	1.20E-10	1.03E-10	1.10E-10	2.75E-10	1.29E-10
^{125m} Te		1.67E-09	4.72E-09	4.18E-11	4.23E-11	4.36E-11	1.27E-10	4.42E-11
^{127m} Te		3.07E-09	1.11E-08	9.52E-11	9.49E-11	9.62E-11	1.25E-10	9.59E-11
¹²⁷ Te		1.17E-09	1.26E-09	3.09E-12	3.02E-12	2.89E-12	4.02E-12	3.17E-12
^{129m} Te		8.41E-09	2.47E-08	1.66E-10	1.62E-10	1.59E-10	2.41E-10	1.65E-10
¹²⁹ Te	0.6500	1.86E-10	3.70E-11	8.84E-13	6.82E-13	4.91E-13	1.59E-12	1.91E-12
¹²⁹ Te		1.86E-10	3.70E-11	8.84E-13	6.82E-13	4.91E-13	1.59E-12	1.91E-12
^{131m} Te		4.65E-09	8.23E-09	1.58E-10	1.24E-10	6.26E-11	7.38E-10	1.65E-10
¹³¹ Te	0.2220	5.26E-10	1.49E-10	7.27E-12	5.28E-12	3.39E-12	1.57E-11	1.44E-11
¹³¹ Te		5.26E-10	1.49E-10	7.27E-12	5.28E-12	3.39E-12	1.57E-11	1.44E-11
¹³² Te		1.87E-09	3.80E-09	3.72E-10	3.65E-10	3.30E-10	5.41E-10	3.69E-10
¹³² I	1.0000	3.32E-11	2.77E-11	3.26E-11	2.84E-11	2.64E-11	2.33E-11	7.73E-11
^{133m} Te		2.74E-10	5.66E-11	2.06E-11	1.40E-11	8.33E-12	3.68E-11	5.16E-11
¹³³ Te	0.1300	9.53E-12	1.92E-12	2.09E-12	1.43E-12	1.22E-12	1.85E-12	7.48E-12
¹³³ Te		9.53E-12	1.92E-12	2.09E-12	1.43E-12	1.22E-12	1.85E-12	7.48E-12
¹³⁴ Te		7.32E-11	2.43E-11	1.77E-11	1.57E-11	1.29E-11	2.03E-11	2.91E-11
¹³⁴ I	1.0000	1.75E-11	1.29E-11	1.75E-11	1.40E-11	1.26E-11	1.10E-11	5.39E-11
¹²⁵ I		3.10E-11	2.97E-11	2.71E-11	2.94E-11	4.08E-11	2.93E-11	3.33E-11
¹²⁹ I		1.42E-10	1.39E-10	1.34E-10	1.38E-10	1.65E-10	1.38E-10	1.41E-10
¹³⁰ I		7.00E-11	6.36E-11	6.78E-11	6.40E-11	7.18E-11	5.31E-11	1.20E-10
¹³¹ I		4.43E-11	4.24E-11	4.51E-11	4.95E-11	1.02E-10	4.07E-11	5.98E-11
¹³² I		3.32E-11	2.77E-11	3.26E-11	2.84E-11	2.64E-11	2.33E-11	7.73E-11
¹³³ I		4.08E-11	3.89E-11	3.99E-11	3.93E-11	4.53E-11	3.57E-11	5.57E-11

Table E.4 Ingestion organ dose equivalent factors for organ set 2 (Continued)

Radio-nuclide	Implicit progeny fraction	Organ name (Sv/Bq)						
		ULI wall	LLI wall	Kidneys	Liver	Lungs	Ovaries	Pancreas
¹³⁴ I		1.75E-11	1.29E-11	1.75E-11	1.40E-11	1.26E-11	1.10E-11	5.39E-11
¹³⁵ I		4.19E-11	3.93E-11	4.08E-11	3.82E-11	3.75E-11	3.61E-11	7.60E-11
^{135m} Xe	0.1540	Note: Contribution included with parent.						
^{134m} Cs		7.20E-12	7.11E-12	6.88E-12	6.83E-12	6.42E-12	6.48E-12	7.82E-12
¹³⁴ Cs		2.14E-08	2.19E-08	2.01E-08	2.01E-08	1.76E-08	1.81E-08	1.94E-08
¹³⁵ Cs		1.91E-09	1.91E-09	1.91E-09	1.91E-09	1.91E-09	1.91E-09	1.91E-09
¹³⁶ Cs		3.29E-09	3.40E-09	3.16E-09	3.15E-09	2.62E-09	2.71E-09	3.08E-09
¹³⁷ Cs		1.42E-08	1.44E-08	1.37E-08	1.36E-08	1.27E-08	1.29E-08	1.34E-08
^{137m} Ba	0.9460	Note: Contribution included with parent.						
¹³⁸ Cs		1.20E-11	8.77E-12	1.16E-11	9.44E-12	8.53E-12	8.00E-12	3.56E-11
¹³⁹ Ba		4.38E-10	9.86E-11	7.95E-13	6.02E-13	3.89E-13	1.56E-12	1.58E-12
¹⁴⁰ Ba		7.75E-09	2.64E-08	1.51E-10	1.17E-10	6.63E-11	9.96E-10	1.36E-10
¹⁴¹ Ba		2.16E-10	1.15E-10	2.52E-12	1.60E-12	1.10E-12	2.86E-12	9.16E-12
¹⁴² Ba		9.37E-11	2.43E-11	4.97E-12	3.37E-12	1.67E-12	9.88E-12	1.33E-11
¹⁴⁰ La		9.12E-09	1.75E-08	2.23E-10	1.69E-10	4.01E-11	1.34E-09	2.19E-10
¹⁴¹ La		2.46E-09	1.45E-09	1.20E-12	1.26E-12	2.72E-13	3.77E-12	1.75E-12
¹⁴² La		7.18E-10	1.91E-10	2.96E-11	2.08E-11	8.40E-12	6.99E-11	6.42E-11
¹⁴¹ Ce		2.99E-09	8.64E-09	1.19E-11	1.96E-11	1.43E-12	1.08E-10	1.23E-11
¹⁴³ Ce		5.71E-09	1.17E-08	2.79E-11	2.18E-11	3.82E-12	2.12E-10	2.97E-11
¹⁴⁴ Ce		2.22E-08	6.64E-08	1.30E-11	6.91E-10	6.52E-12	6.98E-11	1.30E-11
^{144m} Pr	0.0178	Note: Contribution included with parent.						
¹⁴⁴ Pr	1.0000	1.78E-11	9.68E-13	7.26E-14	4.72E-14	3.15E-14	7.38E-14	2.76E-13
¹⁴³ Pr		5.15E-09	1.47E-08	1.70E-12	8.23E-12	1.91E-19	8.99E-18	1.13E-18
¹⁴⁴ Pr		1.78E-11	9.68E-13	7.26E-14	4.72E-14	3.15E-14	7.38E-14	2.76E-13
¹⁴⁷ Nd		4.63E-09	1.28E-08	1.91E-11	1.88E-11	2.44E-12	1.79E-10	1.90E-11
¹⁴⁷ Pm		1.05E-09	3.17E-09	8.46E-16	6.97E-11	1.96E-16	6.86E-15	8.80E-16
^{148m} Pm		5.79E-09	1.37E-08	2.83E-10	2.25E-10	4.44E-11	2.18E-09	2.66E-10
¹⁴⁸ Pm		1.19E-08	3.10E-08	6.99E-11	5.57E-11	1.19E-11	4.72E-10	6.47E-11
¹⁴⁹ Pm		5.00E-09	1.14E-08	1.23E-12	1.89E-12	1.62E-13	9.19E-12	1.26E-12
¹⁵¹ Pm		3.85E-09	7.05E-09	3.07E-11	2.23E-11	4.23E-12	2.11E-10	3.26E-11
¹⁴⁷ Sm		7.49E-09	2.30E-08	0.00E+00	2.36E-07	0.00E+00	0.00E+00	0.00E+00
¹⁵¹ Sm		3.37E-10	1.01E-09	5.16E-16	9.21E-11	6.52E-16	2.12E-14	7.36E-16
¹⁵³ Sm		3.73E-09	8.18E-09	7.19E-12	5.80E-12	7.13E-13	7.17E-11	8.06E-12
¹⁵² Eu		4.21E-09	1.00E-08	4.65E-10	2.99E-09	2.40E-10	1.33E-09	4.71E-10
¹⁵⁴ Eu		6.87E-09	1.80E-08	4.49E-10	3.69E-09	2.16E-10	1.37E-09	4.44E-10
¹⁵⁵ Eu		1.21E-09	3.45E-09	2.37E-11	4.13E-10	9.64E-12	9.83E-11	2.23E-11
¹⁵⁶ Eu		8.63E-09	2.28E-08	1.86E-10	1.59E-10	3.24E-11	1.22E-09	1.64E-10
¹⁵³ Gd		1.02E-09	2.71E-09	1.69E-11	2.75E-11	2.19E-12	1.97E-10	1.74E-11
¹⁶⁰ Tb		5.91E-09	1.56E-08	1.63E-10	1.34E-10	2.72E-11	1.17E-09	1.48E-10
^{166m} Ho		4.97E-09	1.12E-08	5.17E-10	2.05E-09	2.16E-10	2.05E-09	3.10E-09
¹⁸¹ W		2.81E-10	7.11E-10	8.70E-12	4.97E-12	6.23E-13	7.33E-11	6.60E-12
¹⁸⁵ W		2.12E-09	6.32E-09	1.32E-11	2.35E-12	9.45E-16	8.74E-14	9.32E-15

Table E.4 Ingestion organ dose equivalent factors for organ set 2 (Continued)

Radio-nuclide	Implicit progeny fraction	Organ name (Sv/Bq)						
		ULI wall	LLI wall	Kidneys	Liver	Lungs	Ovaries	Pancreas
¹⁸⁷ W		3.56E-09	5.99E-09	4.34E-11	3.03E-11	6.39E-12	2.59E-10	4.38E-11
¹⁸⁷ Re		2.64E-12	7.16E-12	3.94E-13	5.37E-13	3.94E-13	3.94E-13	3.94E-13
¹⁸⁵ Os		1.44E-09	2.83E-09	2.48E-10	2.48E-10	5.24E-11	8.35E-10	1.60E-10
¹⁹¹ Os		2.37E-09	6.61E-09	5.92E-11	5.05E-11	5.06E-12	1.18E-10	1.69E-11
¹⁹² Ir		4.90E-09	1.29E-08	4.81E-10	4.43E-10	6.54E-11	1.03E-09	1.92E-10
¹⁹⁸ Au		4.67E-09	1.07E-08	6.25E-11	4.95E-11	2.44E-11	3.43E-10	6.38E-11
²⁰³ Hg		1.45E-09	1.34E-09	1.88E-08	1.42E-09	1.23E-09	1.37E-09	1.68E-09
²¹⁰ Pb		1.26E-07	1.30E-07	2.81E-06	6.08E-06	1.25E-07	1.25E-07	1.25E-07
²¹² Pb		1.67E-08	1.99E-08	1.09E-08	2.21E-08	1.63E-09	1.96E-09	1.69E-09
²¹² Bi	1.0000	6.61E-10	1.27E-10	1.11E-09	1.36E-11	9.86E-12	2.76E-11	3.18E-11
²¹² Po	0.6407	Note: Contribution included with parent.						
²⁰⁸ Tl	0.3593	Note: Contribution included with parent.						
²¹⁰ Bi		5.77E-09	1.54E-08	5.88E-09	1.97E-11	1.97E-11	1.97E-11	1.97E-11
²¹² Bi		6.61E-10	1.27E-10	1.11E-09	1.36E-11	9.86E-12	2.76E-11	3.18E-11
²¹² Po	0.6407	Note: Contribution included with parent.						
²⁰⁸ Tl	0.3593	Note: Contribution included with parent.						
²¹⁰ Po		9.82E-08	1.31E-07	2.55E-06	4.39E-07	8.23E-08	8.23E-08	8.23E-08
²²² Rn		9.82E-08	1.31E-07	2.55E-06	4.39E-07	8.23E-08	8.23E-08	8.23E-08
²¹⁸ Po	1.0000	Note: Contribution included with parent.						
²¹⁴ Pb	1.0000	2.49E-10	4.89E-11	4.17E-11	5.68E-11	2.32E-11	3.19E-11	3.86E-11
²¹⁴ Bi	1.0000	5.86E-11	7.31E-12	6.25E-11	3.25E-12	2.38E-12	5.17E-12	1.58E-11
²¹⁴ Po	0.9998	Note: Contribution included with parent.						
²²³ Ra		1.25E-07	2.77E-07	4.23E-08	4.23E-08	4.23E-08	4.26E-08	4.23E-08
²¹⁹ Rn	1.000	Note: Contribution included with parent.						
²¹⁵ Po	1.000	Note: Contribution included with parent.						
²¹¹ Pb	1.000	2.27E-10	4.14E-11	2.73E-11	3.68E-11	1.90E-11	1.97E-11	2.06E-11
²¹¹ Bi	1.000	Note: Contribution included with parent.						
²¹¹ Po	0.0028	Note: Contribution included with parent.						
²⁰⁷ Tl	0.9972	Note: Contribution included with parent.						
²²⁴ Ra		8.25E-08	1.99E-07	2.06E-08	2.06E-08	2.05E-08	2.12E-08	2.06E-08
²²⁰ Rn	1.000	Note: Contribution included with parent.						
²¹⁶ Po	1.000	Note: Contribution included with parent.						
²²⁵ Ra		3.91E-08	6.39E-08	3.37E-08	3.37E-08	3.37E-08	3.37E-08	3.37E-08
²²⁶ Ra		1.05E-07	1.31E-07	9.16E-08	9.15E-08	9.16E-08	9.16E-08	9.17E-08
²²⁸ Ra		1.63E-07	1.78E-07	1.57E-07	1.57E-07	1.57E-07	1.58E-07	1.57E-07
²²⁸ Ac	1.0000	2.42E-09	1.90E-09	3.88E-11	8.20E-10	7.34E-12	1.79E-10	5.05E-11
²²⁵ Ac		9.77E-08	2.82E-07	2.96E-11	2.70E-08	3.98E-12	1.36E-09	2.60E-11
²²¹ Fr	1.000	Note: Contribution included with parent.						
²¹⁷ At	1.000	Note: Contribution included with parent.						
²¹³ Bi	1.000	4.27E-10	1.04E-10	6.05E-10	4.92E-12	4.56E-12	6.17E-12	7.69E-12
²¹³ Po	0.9784	Note: Contribution included with parent.						
²⁰⁹ Tl	0.0216	Note: Contribution included with parent.						

Table E.4 Ingestion organ dose equivalent factors for organ set 2 (Continued)

Radio-nuclide	Implicit progeny fraction	Organ name (Sv/Bq)						
		ULI wall	LLI wall	Kidneys	Liver	Lungs	Ovaries	Pancreas
²⁰⁹ Pb	1.000	3.50E-10	1.73E-10	1.66E-12	3.02E-12	5.37E-13	5.37E-13	5.37E-13
²²⁷ Ac		1.52E-09	7.66E-09	2.95E-10	1.54E-05	2.20E-10	8.31E-07	3.24E-10
²²³ Fr	0.0138	2.32E-09	2.32E-09	2.32E-09	2.32E-09	2.32E-09	2.32E-09	2.32E-09
²²⁸ Ac		2.42E-09	1.90E-09	3.88E-11	8.20E-10	7.34E-12	1.79E-10	5.05E-11
²²⁷ Th		2.53E-08	9.13E-08	1.41E-10	1.06E-09	1.25E-10	2.95E-10	1.40E-10
²²⁸ Th		3.11E-08	1.32E-07	2.33E-09	2.01E-08	2.31E-09	2.53E-09	2.32E-09
²²⁹ Th		2.32E-08	6.32E-08	4.57E-09	3.98E-08	4.56E-09	4.69E-09	4.57E-09
²³⁰ Th		1.65E-08	4.93E-08	6.80E-10	5.94E-09	6.80E-10	6.82E-10	6.80E-10
²³¹ Th		1.90E-09	3.42E-09	1.26E-12	9.78E-13	1.43E-13	2.08E-11	1.72E-12
²³² Th		1.47E-08	4.27E-08	1.25E-09	1.02E-08	1.25E-09	1.25E-09	1.25E-09
²³⁴ Th		1.47E-08	4.30E-08	3.71E-12	4.17E-12	7.05E-13	3.12E-11	3.49E-12
^{234m} Pa	0.9980	Note: Contribution included with parent.						
²³⁴ Pa	0.0020	3.13E-09	2.46E-09	8.29E-11	5.88E-11	1.51E-11	3.30E-10	1.06E-10
²³¹ Pa		1.75E-08	5.35E-08	6.79E-09	4.36E-09	6.80E-11	1.21E-10	7.19E-11
²³³ Pa		3.62E-09	1.02E-08	3.40E-11	2.41E-11	3.70E-12	2.58E-10	2.93E-11
²³⁴ Pa		3.13E-09	2.46E-09	8.29E-11	5.88E-11	1.51E-11	3.30E-10	1.06E-10
²³² U		2.53E-08	6.09E-08	1.57E-06	8.21E-09	8.29E-09	8.27E-09	8.30E-09
²³³ U		1.80E-08	4.98E-08	4.74E-07	2.62E-09	2.62E-09	2.62E-09	2.62E-09
²³⁴ U		1.79E-08	4.95E-08	4.68E-07	2.58E-09	2.58E-09	2.59E-09	2.58E-09
²³⁵ U		1.84E-08	5.31E-08	4.33E-07	2.46E-09	2.46E-09	2.67E-09	2.49E-09
²³⁶ U		1.69E-08	4.68E-08	4.43E-07	2.45E-09	2.45E-09	2.45E-09	2.45E-09
²³⁷ U		3.37E-09	8.89E-09	2.96E-11	1.33E-11	2.17E-12	1.81E-10	2.02E-11
²³⁸ U		1.61E-08	4.57E-08	4.15E-07	2.30E-09	2.30E-09	2.31E-09	2.30E-09
²⁴⁰ U		6.99E-09	9.50E-09	2.62E-11	1.62E-11	3.69E-12	1.24E-10	2.35E-11
^{240m} Np	1.0000	Note: Contribution included with parent.						
²³⁷ Np		1.74E-08	5.32E-08	1.65E-10	9.73E-07	1.53E-10	2.46E-07	1.78E-10
²³⁸ Np		4.20E-09	8.93E-09	6.00E-11	1.07E-10	1.02E-11	3.89E-10	5.74E-11
²³⁹ Np		3.85E-09	8.72E-09	2.05E-11	1.54E-11	2.40E-12	1.62E-10	2.16E-11
²³⁶ Pu		1.94E-08	5.96E-08	4.34E-13	1.13E-08	3.49E-13	7.85E-10	4.93E-13
²³⁷ Pu		3.96E-10	1.03E-09	7.30E-12	4.93E-12	7.54E-13	7.22E-11	7.56E-12
²³⁸ Pu		1.85E-08	5.68E-08	9.03E-14	2.92E-08	8.64E-14	2.33E-09	1.21E-13
²³⁹ Pu		1.73E-08	5.31E-08	8.78E-14	3.14E-08	7.89E-14	2.64E-09	9.95E-14
²⁴⁰ Pu		1.74E-08	5.34E-08	8.69E-14	3.14E-08	8.22E-14	2.64E-09	1.17E-13
²⁴¹ Pu		8.96E-11	2.70E-10	5.15E-15	5.44E-10	4.48E-15	5.66E-11	5.56E-15
²⁴² Pu		1.65E-08	5.06E-08	1.75E-13	2.98E-08	9.18E-14	2.51E-09	1.98E-13
²⁴³ Pu		5.99E-10	4.10E-10	9.94E-13	6.19E-13	1.47E-13	4.56E-12	1.57E-12
²⁴⁴ Pu		2.39E-08	8.35E-08	4.94E-11	2.96E-08	9.29E-12	2.94E-09	4.38E-11
²⁴¹ Am		1.90E-08	5.82E-08	3.99E-11	3.25E-06	3.36E-11	2.70E-07	4.24E-11
^{242m} Am		2.38E-09	9.72E-09	1.94E-11	3.09E-06	1.65E-11	2.66E-07	2.04E-11
²⁴² Am		1.66E-09	2.54E-09	1.17E-12	3.84E-10	1.58E-13	2.74E-11	1.46E-12
²⁴³ Am		1.91E-08	6.03E-08	2.58E-10	3.22E-06	1.95E-10	2.71E-07	2.76E-10
²⁴² Cm		2.05E-08	6.25E-08	8.84E-12	1.13E-07	8.84E-12	5.20E-09	8.88E-12

Table E.4 Ingestion organ dose equivalent factors for organ set 2 (Continued)

Radio-nuclide	Implicit progeny fraction	Organ name (Sv/Bq)						
		ULI wall	LLI wall	Kidneys	Liver	Lungs	Ovaries	Pancreas
²⁴³ Cm		2.20E-08	6.69E-08	1.15E-10	2.39E-06	7.73E-11	1.73E-07	1.21E-10
²⁴⁴ Cm		1.95E-08	5.97E-08	8.75E-12	1.99E-06	8.81E-12	1.33E-07	8.77E-12
²⁴⁵ Cm		1.93E-08	5.86E-08	1.17E-10	3.31E-06	8.34E-11	2.80E-07	1.24E-10
²⁴⁶ Cm		1.83E-08	5.62E-08	5.80E-11	3.30E-06	2.67E-11	2.77E-07	5.30E-11
²⁴⁷ Cm		1.98E-08	6.06E-08	3.88E-10	3.03E-06	2.66E-10	2.56E-07	4.32E-10
²⁴³ Pu	1.0000	5.99E-10	4.10E-10	9.94E-13	6.91E-13	1.47E-13	4.56E-12	1.57E-12
²⁴⁸ Cm		1.06E-07	2.88E-07	1.78E-08	1.20E-05	6.52E-09	1.02E-06	1.60E-08
²⁵² Cf		5.25E-08	1.53E-07	1.60E-09	5.65E-07	4.67E-10	5.39E-08	1.46E-09

Table E.5 Ingestion organ dose equivalent factors for organ set 3

Radio-nuclide	Implicit progeny fraction	Organ name (Sv/Bq)						
		R marrow	Skin	Spleen	Testes	Thymus	Thyroid	Uterus
³ H		1.73E-11	1.73E-11	1.73E-11	1.73E-11	1.73E-11	1.73E-11	1.73E-11
¹⁰ Be		7.23E-10	2.42E-11	2.42E-11	2.42E-11	2.42E-11	2.42E-11	2.42E-11
¹⁴ C		5.64E-10	5.64E-10	5.64E-10	5.64E-10	5.64E-10	5.64E-10	5.64E-10
¹⁸ F		5.94E-11	4.25E-12	1.72E-11	2.27E-12	3.33E-12	4.52E-12	3.57E-12
²² Na		4.29E-09	1.91E-09	2.73E-09	2.69E-09	2.52E-09	2.50E-09	2.86E-09
²⁴ Na		3.74E-10	2.11E-10	3.14E-10	2.82E-10	3.02E-10	2.60E-10	3.26E-10
³² P		8.09E-09	6.55E-10	6.55E-10	6.55E-10	6.55E-10	6.55E-10	6.55E-10
³³ P		4.99E-10	9.37E-11	9.37E-11	9.37E-11	9.37E-11	9.37E-11	9.37E-11
³⁵ S		9.53E-12	9.53E-12	9.53E-12	9.53E-12	9.53E-12	9.53E-12	9.53E-12
³⁶ Cl		7.99E-10	7.99E-10	7.99E-10	7.99E-10	7.99E-10	7.99E-10	7.99E-10
⁴⁰ K		4.91E-09	4.76E-09	4.91E-09	4.93E-09	5.02E-09	4.85E-09	4.96E-09
⁴¹ Ca		1.78E-09	3.34E-12	3.64E-12	2.60E-12	3.03E-12	2.84E-12	2.60E-12
⁴⁵ Ca		3.47E-09	5.36E-11	5.36E-11	5.36E-11	5.36E-11	5.36E-11	5.36E-11
⁴⁶ Sc		4.03E-10	9.68E-11	2.43E-10	1.76E-10	2.18E-11	7.69E-12	8.52E-10
⁵¹ Cr		1.25E-11	3.95E-12	7.46E-12	6.78E-12	5.04E-12	3.71E-12	1.88E-11
⁵⁴ Mn		4.89E-10	1.60E-10	2.65E-10	2.11E-10	1.60E-10	1.33E-10	5.03E-10
⁵⁶ Mn		2.43E-11	7.84E-12	3.54E-11	7.70E-12	4.45E-12	2.40E-12	5.88E-11
⁵⁵ Fe		1.05E-10	9.99E-11	5.64E-10	1.05E-10	1.03E-10	1.10E-10	1.05E-10
⁵⁹ Fe		8.45E-10	5.03E-10	1.82E-09	7.47E-10	6.32E-10	6.03E-10	1.25E-09
⁵⁷ Co		2.67E-10	1.04E-10	1.80E-10	1.38E-10	1.66E-10	1.15E-10	2.48E-10
⁵⁸ Co		5.40E-10	2.75E-10	5.10E-10	4.91E-10	3.54E-10	3.64E-10	7.85E-10
⁶⁰ Co		5.49E-09	3.54E-09	5.58E-09	5.42E-09	5.27E-09	4.68E-09	7.13E-09
⁵⁹ Ni		3.66E-11	3.40E-11	3.74E-11	3.65E-11	3.53E-11	3.90E-11	3.66E-11
⁶³ Ni		8.50E-11	8.50E-11	8.50E-11	8.50E-11	8.50E-11	8.50E-11	8.50E-11
⁶⁵ Ni		7.26E-12	2.51E-12	1.17E-11	2.25E-12	1.43E-12	6.79E-13	1.93E-11
⁶⁴ Cu		1.94E-11	1.14E-11	1.88E-11	1.47E-11	1.16E-11	1.13E-11	2.83E-11
⁶⁵ Zn		4.50E-09	2.29E-09	3.63E-09	3.56E-09	3.03E-09	3.21E-09	4.72E-09
^{69m} Zn		9.15E-11	3.31E-11	5.04E-11	4.10E-11	3.51E-11	3.28E-11	7.49E-11
⁶⁹ Zn	0.9997	5.36E-13	4.17E-13	4.17E-13	4.17E-13	4.17E-13	4.17E-13	4.17E-13
⁶⁹ Zn		5.36E-13	4.17E-13	4.17E-13	4.17E-13	4.17E-13	4.17E-13	4.17E-13
⁷⁶ As		1.20E-10	9.52E-11	2.44E-10	1.06E-10	9.54E-11	9.35E-11	1.50E-10
⁷⁵ Se		2.07E-09	8.76E-10	3.65E-09	1.18E-09	1.85E-09	1.13E-09	1.90E-09
⁷⁹ Se		9.06E-10	9.06E-10	4.32E-09	9.06E-10	9.06E-10	9.06E-10	9.06E-10
⁸² Br		4.14E-10	2.65E-10	4.83E-10	4.48E-10	3.87E-10	3.83E-10	5.05E-10
⁸³ Br		7.35E-12	7.31E-12	7.45E-12	7.34E-12	7.33E-12	7.33E-12	7.35E-12
^{83m} Kr	1.0000	Note: Contribution included with parent.						
⁸⁴ Br		6.21E-12	5.19E-12	1.62E-11	5.27E-12	5.88E-12	5.20E-12	6.93E-12
⁸⁶ Rb		3.72E-09	2.11E-09	2.16E-09	2.15E-09	2.13E-09	2.14E-09	2.20E-09
⁸⁸ Rb		2.76E-12	2.52E-12	5.24E-12	2.45E-12	2.61E-12	2.43E-12	2.77E-12
⁸⁹ Rb		3.53E-12	2.47E-12	1.09E-11	2.26E-12	2.76E-12	2.21E-12	3.25E-12
⁸⁵ Sr		5.97E-10	1.66E-10	2.39E-10	2.15E-10	1.78E-10	2.05E-10	3.27E-10
⁸⁹ Sr		3.23E-09	2.40E-10	2.40E-10	2.40E-10	2.40E-10	2.40E-10	2.40E-10

Table E.5 Ingestion organ dose equivalent factors for organ set 3 (Continued)

Radio-nuclide	Implicit progeny fraction	Organ name (Sv/Bq)						
		R marrow	Skin	Spleen	Testes	Thymus	Thyroid	Uterus
⁹⁰ Sr		1.94E-07	1.51E-09	1.51E-09	1.51E-09	1.51E-09	1.51E-09	1.51E-09
⁹¹ Sr		5.53E-11	1.38E-11	4.21E-11	1.98E-11	4.51E-12	1.90E-12	1.26E-10
^{91m} Y	0.5780	2.24E-12	7.09E-13	6.39E-12	3.23E-13	2.67E-13	1.17E-13	5.75E-12
⁹⁰ Y		3.70E-13	1.26E-14	1.26E-14	1.26E-14	1.26E-14	1.26E-14	1.26E-14
^{91m} Y		2.24E-12	7.09E-13	6.39E-12	3.23E-13	2.67E-13	1.17E-13	5.75E-12
⁹¹ Y		6.59E-12	2.90E-13	5.08E-13	4.14E-13	1.54E-13	1.29E-13	1.63E-12
⁹² Y		4.91E-12	1.40E-12	6.46E-12	1.39E-12	5.90E-13	1.77E-13	1.30E-11
⁹³ Y		4.93E-12	1.21E-12	3.87E-12	1.77E-12	3.60E-13	1.26E-13	1.13E-11
⁹³ Zr		7.42E-10	2.25E-13	1.83E-13	4.62E-14	1.05E-13	7.31E-14	4.75E-14
⁹⁵ Zr		2.14E-10	4.19E-11	8.83E-11	8.04E-11	1.31E-11	8.27E-12	3.33E-10
⁹⁷ Zr		1.30E-10	3.04E-11	8.02E-11	5.21E-11	7.53E-12	2.66E-12	2.83E-10
^{97m} Nb	0.9470	Note: Contribution included with parent.						
⁹⁷ Nb	0.0530	4.20E-12	1.28E-12	9.72E-12	7.83E-13	5.71E-13	2.11E-13	1.11E-11
^{93m} Nb		2.32E-11	2.43E-12	3.29E-11	3.34E-11	2.51E-12	2.44E-12	2.51E-12
⁹⁴ Nb		7.39E-10	1.85E-10	6.27E-10	5.25E-10	1.34E-10	1.23E-10	8.21E-10
^{95m} Nb		3.33E-11	4.24E-12	1.52E-11	1.45E-11	1.97E-12	1.63E-12	3.44E-11
⁹⁵ Nb		1.99E-10	4.40E-11	1.12E-10	9.66E-11	1.65E-11	1.18E-11	3.35E-10
^{97m} Nb		1.99E-10	4.40E-11	1.12E-10	9.66E-11	1.65E-11	1.18E-11	3.35E-10
⁹⁷ Nb		4.20E-12	1.28E-12	9.72E-12	7.83E-13	5.71E-13	2.11E-13	1.11E-11
⁹³ Mo		2.82E-10	7.28E-11	9.64E-11	8.30E-11	1.20E-10	9.42E-11	9.43E-11
⁹⁹ Mo		8.32E-11	1.74E-11	3.10E-11	2.72E-11	1.22E-11	1.03E-11	9.93E-11
^{99m} Tc	0.8760	6.29E-12	1.91E-12	7.03E-12	2.29E-12	3.07E-12	8.46E-11	7.17E-12
^{99m} Tc		6.29E-12	1.91E-12	7.03E-12	2.29E-12	3.07E-12	8.46E-11	7.17E-12
⁹⁹ Tc		6.04E-11	6.04E-11	6.04E-11	6.04E-11	6.04E-11	1.62E-09	6.04E-11
¹⁰¹ Tc		4.36E-13	2.01E-13	1.85E-12	1.22E-13	1.55E-13	3.89E-12	6.39E-13
¹⁰³ Ru		1.66E-10	6.85E-11	1.18E-10	1.22E-10	6.73E-11	6.25E-11	2.66E-10
¹⁰⁵ Ru		2.35E-11	6.51E-12	2.50E-11	7.59E-12	3.02E-12	1.82E-12	5.53E-11
¹⁰⁶ Ru		1.46E-09	1.40E-09	1.45E-09	1.45E-09	1.42E-09	1.41E-09	1.52E-09
¹⁰⁶ Rh	1.0000	Note: Contribution included with parent.						
^{103m} Rh		1.01E-14	3.58E-15	1.11E-14	3.23E-15	3.32E-15	3.27E-15	1.60E-14
¹⁰⁵ Rh		1.47E-11	4.69E-12	8.68E-12	7.22E-12	3.41E-12	2.91E-12	2.61E-11
¹⁰³ Pd		6.58E-12	1.83E-13	2.78E-13	1.55E-13	4.87E-14	4.40E-14	1.88E-12
^{103m} Rh	0.99974	1.01E-14	3.58E-15	1.11E-14	3.23E-15	3.32E-15	3.27E-15	1.60E-14
¹⁰⁷ Pd		5.36E-14	9.91E-15	9.91E-15	9.91E-15	9.91E-15	9.91E-15	9.91E-15
¹⁰⁹ Pd		2.04E-12	1.80E-13	4.54E-13	2.19E-13	1.03E-13	9.48E-14	1.71E-12
^{110m} Ag		9.42E-10	3.75E-10	7.13E-10	4.37E-10	4.04E-10	1.81E-10	1.41E-09
¹¹⁰ Ag	0.0133	Note: Contribution included with parent.						
¹¹¹ Ag		1.38E-11	8.53E-12	1.03E-11	9.85E-12	8.01E-12	7.48E-12	1.90E-11
¹⁰⁹ Cd		3.70E-10	2.55E-10	4.27E-10	2.57E-10	2.94E-10	2.75E-10	2.87E-10
^{113m} Cd		3.44E-09	3.44E-09	3.44E-09	3.44E-09	3.44E-09	3.44E-09	3.44E-09
^{115m} Cd		1.68E-10	1.62E-10	1.72E-10	1.63E-10	1.62E-10	1.61E-10	1.72E-10
¹¹⁵ Cd		7.40E-11	2.05E-11	4.37E-11	3.58E-11	1.23E-11	9.49E-12	1.28E-10

Table E.5 Ingestion organ dose equivalent factors for organ set 3 (Continued)

Radio-nuclide	Implicit progeny fraction	Organ name (Sv/Bq)						
		R marrow	Skin	Spleen	Testes	Thymus	Thyroid	Uterus
^{115m} In	1.0000	6.11E-12	1.08E-12	5.23E-12	1.22E-12	3.69E-13	1.86E-13	1.17E-11
¹¹¹ In		1.08E-10	1.39E-11	4.18E-11	3.07E-11	4.56E-12	2.10E-12	1.65E-10
^{114m} In		3.51E-09	1.20E-10	9.94E-10	1.26E-10	1.20E-10	1.17E-10	1.65E-10
¹¹⁴ In	0.9570	Note: Contribution included with parent.						
^{115m} In		6.11E-12	1.08E-12	5.23E-12	1.22E-12	3.69E-13	1.86E-13	1.17E-11
^{117m} Sn		1.03E-10	8.32E-12	1.88E-11	1.67E-11	3.79E-12	3.03E-12	8.51E-11
^{119m} Sn		8.07E-11	8.79E-12	9.40E-12	8.92E-12	9.07E-12	8.89E-12	1.24E-11
^{121m} Sn		2.32E-10	2.85E-11	2.90E-11	2.86E-11	2.87E-11	2.86E-11	3.08E-11
¹²¹ Sn		2.23E-12	2.00E-13	2.00E-13	2.00E-13	2.00E-13	2.00E-13	2.00E-13
¹²³ Sn		2.41E-10	3.16E-11	3.21E-11	3.19E-11	3.14E-11	3.13E-11	3.43E-11
¹²⁵ Sn		2.08E-10	2.21E-11	4.03E-11	3.41E-11	1.19E-11	9.78E-12	1.28E-10
¹²⁶ Sn		2.72E-09	5.48E-10	7.28E-10	6.80E-10	5.32E-10	5.51E-10	1.27E-09
^{126m} Sb	1.0000	2.16E-12	8.23E-13	9.71E-12	2.95E-13	4.60E-13	1.73E-13	4.60E-12
¹²⁴ Sb		3.81E-10	9.54E-11	2.00E-10	1.84E-10	3.04E-11	1.76E-11	7.55E-10
¹²⁵ Sb		2.26E-10	5.46E-11	9.43E-11	9.04E-11	5.25E-11	4.62E-11	2.30E-10
^{126m} Sb		2.16E-12	8.23E-13	9.71E-12	2.95E-13	4.60E-13	1.73E-13	4.60E-12
¹²⁶ Sb		5.93E-10	1.32E-10	3.03E-10	2.79E-10	3.44E-11	1.74E-11	1.18E-09
¹²⁷ Sb		1.33E-10	2.90E-11	6.68E-11	5.89E-11	8.28E-12	4.64E-12	2.54E-10
^{123m} Te		2.33E-09	8.69E-11	1.03E-10	9.40E-11	8.54E-11	9.44E-11	1.59E-10
^{125m} Te		1.21E-09	3.82E-11	4.30E-11	3.82E-11	3.92E-11	3.93E-11	5.27E-11
^{127m} Te		5.43E-09	9.37E-11	9.55E-11	9.31E-11	9.34E-11	9.43E-11	9.86E-11
¹²⁷ Te		6.57E-12	2.90E-12	3.06E-12	2.93E-12	2.87E-12	2.86E-12	3.41E-12
^{129m} Te		3.50E-09	1.56E-10	1.63E-10	1.61E-10	1.56E-10	1.57E-10	1.83E-10
¹²⁹ T ₉	0.6500	7.64E-13	4.17E-13	1.20E-12	3.77E-13	3.61E-13	3.36E-13	1.27E-12
¹²⁹ Te		7.64E-13	4.17E-13	1.20E-12	3.77E-13	3.61E-13	3.36E-13	1.27E-12
^{131m} Te		2.42E-10	6.83E-11	1.33E-10	9.86E-11	7.00E-11	4.29E-08	3.59E-10
¹³¹ Te	0.2220	6.60E-12	2.72E-12	9.13E-12	2.11E-12	4.23E-12	4.21E-09	1.18E-11
¹³¹ Te		6.60E-12	2.72E-12	9.13E-12	2.11E-12	4.23E-12	4.21E-09	1.18E-11
¹³² Te		4.44E-10	2.62E-10	3.65E-10	3.63E-10	3.77E-10	5.95E-08	4.63E-10
¹³² I	1.0000	2.46E-11	1.79E-11	5.30E-11	2.21E-11	2.52E-11	3.87E-09	2.69E-11
^{133m} Te		1.31E-11	5.67E-12	3.15E-11	4.45E-12	6.04E-12	4.17E-09	2.96E-11
¹³³ Te	0.1300	1.18E-12	6.97E-13	4.42E-12	4.91E-13	9.76E-13	9.39E-10	1.76E-12
¹³³ Te		1.18E-12	6.97E-13	4.42E-12	4.91E-13	9.76E-13	9.39E-10	1.76E-12
¹³⁴ Te		1.49E-11	9.82E-12	2.18E-11	1.26E-11	1.21E-11	8.82E-10	2.15E-11
¹³⁴ I	1.0000	1.09E-11	7.90E-12	3.42E-11	8.86E-12	9.95E-12	6.21E-10	1.24E-11
¹²⁵ I		6.82E-11	6.96E-11	3.05E-11	2.38E-11	1.27E-10	3.44E-07	2.94E-11
¹²⁹ I		2.21E-10	2.11E-10	1.40E-10	1.29E-10	3.51E-10	2.48E-06	1.38E-10
¹³⁰ I		6.74E-11	5.05E-11	9.34E-11	5.52E-11	1.14E-10	3.94E-08	6.19E-11
¹³¹ I		9.44E-11	8.31E-11	5.53E-11	3.77E-11	3.09E-10	4.76E-07	4.29E-11
¹³² I		2.46E-11	1.79E-11	5.30E-11	2.21E-11	2.52E-11	3.87E-09	2.69E-11
¹³³ I		4.30E-11	3.74E-11	4.78E-11	3.63E-11	7.15E-11	9.10E-08	3.75E-11
¹³⁴ I		1.09E-11	7.90E-12	3.42E-11	8.86E-12	9.95E-12	6.21E-10	1.24E-11

Table E.5 Ingestion organ dose equivalent factors for organ set 3 (Continued)

Radio-nuclide	Implicit progeny fraction	Organ name (Sv/Bq)						
		R marrow	Skin	Spleen	Testes	Thymus	Thyroid	Uterus
¹³⁵ I		3.65E-11	2.94E-11	5.55E-11	3.20E-11	5.12E-11	1.79E-08	3.85E-11
^{135m} Xe	0.1540	Note: Contribution included with parent.						
^{134m} Cs		6.91E-12	5.32E-12	7.30E-12	6.72E-12	6.24E-12	6.22E-12	7.19E-12
¹³⁴ Cs		1.87E-08	1.24E-08	2.01E-08	2.06E-08	1.70E-08	1.76E-08	2.23E-08
¹³⁵ Cs		1.91E-09	1.91E-09	1.91E-09	1.91E-09	1.91E-09	1.91E-09	1.91E-09
¹³⁶ Cs		2.95E-09	1.87E-09	3.14E-09	3.04E-09	2.66E-09	2.74E-09	3.84E-09
¹³⁷ Cs		1.32E-08	1.04E-08	1.37E-08	1.39E-08	1.24E-08	1.26E-08	1.44E-08
^{137m} Ba	0.9460	Note: Contribution included with parent.						
¹³⁸ Cs		7.37E-12	5.93E-12	2.22E-11	6.01E-12	7.04E-12	5.73E-12	7.98E-12
¹³⁹ Ba		8.59E-13	3.35E-13	1.02E-12	3.07E-13	2.89E-13	2.66E-13	1.23E-12
¹⁴⁰ Ba		4.39E-10	8.58E-11	1.27E-10	1.43E-10	5.84E-11	5.25E-11	4.15E-10
¹⁴¹ Ba		1.47E-12	5.58E-13	5.27E-12	3.10E-13	4.08E-13	2.25E-13	2.56E-12
¹⁴² Ba		3.00E-12	1.09E-12	7.88E-12	8.11E-13	7.09E-13	2.71E-13	7.41E-12
¹⁴⁰ La		2.81E-10	7.25E-11	1.75E-10	1.22E-10	1.75E-11	6.40E-12	6.28E-10
¹⁴¹ La		1.07E-12	2.96E-13	1.18E-12	3.18E-13	1.29E-13	5.29E-14	2.55E-12
¹⁴² La		1.93E-11	6.54E-12	3.86E-11	5.30E-12	3.21E-12	1.16E-12	5.17E-11
¹⁴¹ Ce		3.39E-11	3.14E-12	1.80E-11	7.58E-12	5.15E-13	1.80E-13	4.51E-11
¹⁴³ Ce		5.07E-11	7.48E-12	2.25E-11	1.53E-11	1.43E-12	4.35E-13	8.53E-11
¹⁴⁴ Ce		8.92E-11	7.39E-12	5.75E-10	1.02E-11	5.54E-12	5.15E-12	3.07E-11
^{144m} Pr	0.0178	Note: Contribution included with parent.						
¹⁴⁴ Pr	1.0000	3.22E-14	1.51E-14	1.58E-13	6.73E-15	1.05E-14	3.59E-15	6.84E-14
¹⁴³ Pr		1.03E-12	4.01E-19	9.34E-19	8.32E-19	8.24E-20	2.66E-20	3.67E-18
¹⁴⁴ Pr		3.22E-14	1.51E-14	1.58E-13	6.73E-15	1.05E-14	3.59E-15	6.84E-14
¹⁴⁷ Nd		5.05E-11	5.77E-12	1.45E-11	1.37E-11	8.94E-13	2.64E-13	6.85E-11
¹⁴⁷ Pm		2.09E-11	2.11E-16	5.56E-16	4.52E-16	5.49E-17	3.12E-17	2.83E-15
^{148m} Pm		4.41E-10	9.46E-11	2.17E-10	2.05E-10	1.92E-11	6.47E-12	8.76E-10
¹⁴⁸ Pm		9.85E-11	2.42E-11	5.50E-11	4.30E-11	5.25E-12	1.85E-12	2.11E-10
¹⁴⁹ Pm		2.27E-12	3.39E-13	9.05E-13	7.49E-13	6.28E-14	1.78E-14	3.81E-12
¹⁵¹ Pm		4.94E-11	8.01E-12	2.31E-11	1.61E-11	1.57E-12	4.55E-13	9.01E-11
¹⁴⁷ Sm		6.87E-08	0.00E+00	0.00E+00	0.00E+00	0.00E+00	0.00E+00	0.00E+00
¹⁵¹ Sm		2.76E-11	2.29E-16	1.97E-16	8.37E-17	4.37E-17	3.27E-17	1.02E-15
¹⁵³ Sm		2.72E-11	1.62E-12	5.56E-12	3.63E-12	1.57E-13	2.36E-14	2.87E-11
¹⁵² Eu		9.19E-10	1.46E-10	2.40E-10	1.58E-10	1.03E-10	6.66E-11	5.94E-10
¹⁵⁴ Eu		1.15E-09	1.41E-10	2.40E-10	1.60E-10	9.72E-11	5.71E-11	6.15E-10
¹⁵⁵ Eu		1.56E-10	4.83E-12	1.06E-11	7.49E-12	2.62E-12	1.78E-12	4.33E-11
¹⁵⁶ Eu		2.56E-10	6.07E-11	1.35E-10	1.17E-10	1.41E-11	5.23E-12	5.14E-10
¹⁵³ Gd		8.07E-11	4.25E-12	1.23E-11	1.04E-11	4.92E-13	2.18E-13	7.23E-11
¹⁶⁰ Tb		2.54E-10	5.40E-11	1.25E-10	1.01E-10	1.21E-11	4.29E-12	4.93E-10
^{166m} Ho		8.12E-10	1.55E-10	3.95E-10	2.17E-10	1.03E-10	5.53E-11	8.64E-10
¹⁸¹ W		3.26E-11	1.66E-12	7.13E-12	4.52E-12	1.19E-13	5.41E-14	3.08E-11
¹⁸⁵ W		1.64E-12	2.32E-15	1.14E-11	5.92E-15	2.44E-16	7.64E-17	3.87E-14
¹⁸⁷ W		5.89E-11	1.14E-11	3.33E-11	2.13E-11	2.45E-12	7.70E-13	1.15E-10

Table E.5 Ingestion organ dose equivalent factors for organ set 3 (Continued)

Radio-nuclide	Implicit progeny fraction	Organ name (Sv/Bq)						
		R marrow	Skin	Spleen	Testes	Thymus	Thyroid	Uterus
¹⁸⁷ Re		3.94E-13	3.94E-13	3.94E-13	3.94E-13	3.94E-13	1.05E-11	3.94E-13
¹⁸⁵ Os		2.16E-10	5.21E-11	2.05E-10	1.02E-10	3.51E-11	2.65E-11	3.60E-10
¹⁹¹ Os		4.82E-11	6.13E-12	4.98E-11	1.09E-11	3.96E-12	3.40E-12	5.37E-11
¹⁹² Ir		2.54E-10	6.80E-11	4.00E-10	1.28E-10	5.36E-11	3.78E-11	4.40E-10
¹⁹⁸ Au		8.57E-11	2.87E-11	5.21E-11	4.80E-11	2.17E-11	1.85E-11	1.53E-10
²⁰³ Hg		1.69E-09	1.03E-09	1.65E-09	1.13E-09	1.48E-09	1.29E-09	1.44E-09
²¹⁰ Pb		1.48E-06	1.25E-07	1.25E-07	1.25E-07	1.25E-07	1.25E-07	1.25E-07
²¹² Pb		1.51E-08	1.64E-09	1.67E-09	1.65E-09	1.63E-09	1.62E-09	1.78E-09
²¹² Bi	1.0000	1.29E-11	8.86E-12	2.16E-11	8.22E-12	7.80E-12	7.11E-12	2.30E-11
²¹² Po	0.6407	Note: Contribution included with parent.						
²⁰⁸ Tl	0.3593	Note: Contribution included with parent.						
²¹⁰ Bi		1.97E-11	1.97E-11	1.97E-11	1.97E-11	1.97E-11	1.97E-11	1.97E-11
²¹² Bi		1.29E-11	8.86E-12	2.16E-11	8.22E-12	7.80E-12	7.11E-12	2.30E-11
²¹² Po	0.6407	Note: Contribution included with parent.						
²⁰⁸ Tl	0.3593	Note: Contribution included with parent.						
²¹⁰ Po		8.23E-08	8.23E-08	4.38E-06	8.23E-08	8.23E-08	8.23E-08	8.23E-08
²²² Rn		8.23E-08	8.23E-08	4.38E-06	8.23E-08	8.23E-08	8.23E-08	8.23E-08
²¹⁸ Po	1.0000	Note: Contribution included with parent.						
²¹⁴ Pb	1.0000	1.12E-10	2.24E-11	3.15E-11	2.19E-11	2.19E-11	2.14E-11	3.05E-11
²¹⁴ Bi	1.0000	2.51E-12	1.49E-12	9.35E-12	1.05E-12	1.29E-12	8.55E-13	4.76E-12
²¹⁴ Po	0.9998	Note: Contribution included with parent.						
²²³ Ra		2.80E-07	4.23E-08	4.23E-08	4.23E-08	4.23E-08	4.23E-08	4.24E-08
²¹⁹ Rn	1.000	Note: Contribution included with parent.						
²¹⁵ Po	1.000	Note: Contribution included with parent.						
²¹¹ Pb	1.000	3.07E-11	1.89E-11	1.98E-11	1.89E-11	1.89E-11	1.88E-11	1.96E-11
²¹¹ Bi	1.000	Note: Contribution included with parent.						
²¹¹ Po	0.0028	Note: Contribution included with parent.						
²⁰⁷ Tl	0.9972	Note: Contribution included with parent.						
²²⁴ Ra		1.52E-07	2.06E-08	2.06E-08	2.06E-08	2.05E-08	2.05E-08	2.08E-08
²²⁰ Rn	1.000	Note: Contribution included with parent.						
²¹⁶ Po	1.000	Note: Contribution included with parent.						
²²⁵ Ra		1.68E-07	3.37E-08	3.37E-08	3.37E-08	3.37E-08	3.37E-08	3.37E-08
²²⁶ Ra		5.98E-07	9.16E-08	9.15E-08	9.15E-08	9.15E-08	9.15E-08	9.15E-08
²²⁸ Ra		6.53E-07	1.57E-07	1.57E-07	1.57E-07	1.57E-07	1.57E-07	1.57E-07
²²⁸ Ac	1.0000	2.75E-10	8.84E-12	3.37E-11	4.38E-11	3.06E-12	9.39E-13	8.43E-11
²²⁵ Ac		7.99E-09	9.43E-12	2.09E-11	1.14E-09	1.68E-12	5.49E-13	9.95E-11
²²¹ Fr	1.000	Note: Contribution included with parent.						
²¹⁷ At	1.000	Note: Contribution included with parent.						
²¹³ Bi	1.000	4.89E-12	4.38E-12	6.19E-12	4.27E-12	4.26E-12	4.20E-12	5.89E-12
²¹³ Po	0.9784	Note: Contribution included with parent.						
²⁰⁹ Tl	0.0216	Note: Contribution included with parent.						
²⁰⁹ Pb	1.000	2.19E-12	5.37E-13	5.37E-13	5.37E-13	5.37E-13	5.37E-13	5.37E-13

Table E.5 Ingestion organ dose equivalent factors for organ set 3 (Continued)

Radio-nuclide	Implicit progeny fraction	Organ name (Sv/Bq)							
		R marrow	Skin	Spleen	Testes	Thymus	Thyroid	Uterus	
²²⁷ Ac	0.0138	5.40E-06	8.62E-11	1.07E-10	8.31E-07	9.10E-11	7.55E-11	7.02E-11	
²²³ Fr		2.32E-09	2.32E-09	2.32E-09	2.32E-09	2.32E-09	2.32E-09	2.32E-09	
²²⁸ Ac		2.75E-10	8.84E-12	3.37E-11	4.38E-11	3.06E-12	9.39E-13	8.43E-11	
²²⁷ Th		5.69E-09	1.28E-10	1.36E-10	1.37E-10	1.24E-10	1.23E-10	1.90E-10	
²²⁸ Th		1.93E-07	2.31E-09	2.32E-09	2.33E-09	2.31E-09	2.30E-09	2.38E-09	
²²⁹ Th		1.91E-06	4.55E-09	4.56E-09	4.56E-09	4.55E-09	4.55E-09	4.60E-09	
²³⁰ Th		2.89E-07	6.80E-10	6.80E-10	6.80E-10	6.80E-10	6.80E-10	6.80E-10	
²³¹ Th		5.30E-12	2.88E-13	1.00E-12	5.24E-13	3.39E-14	8.80E-15	4.85E-12	
²³² Th		1.48E-06	1.24E-09	1.23E-09	1.23E-09	1.23E-09	1.21E-09	1.22E-09	
²³⁴ Th		1.84E-11	1.31E-12	2.90E-12	2.53E-12	4.15E-13	2.88E-13	1.26E-11	
^{234m} Pa		0.9980	Note: Contribution included with parent.						
²³⁴ Pa		0.0020	7.86E-11	1.87E-11	7.04E-11	2.34E-11	6.06E-12	1.86E-12	1.83E-10
²³¹ Pa			5.78E-06	5.45E-11	5.31E-11	4.53E-11	4.02E-11	6.33E-11	6.08E-11
²³³ Pa			6.89E-11	8.58E-12	2.16E-11	2.10E-11	1.41E-12	4.81E-13	1.03E-10
²³⁴ Pa		7.86E-11	1.87E-11	7.04E-11	2.34E-11	6.06E-12	1.86E-12	1.83E-10	
²³² U		4.19E-07	8.24E-09	8.20E-09	8.26E-09	8.20E-09	8.11E-09	8.14E-09	
²³³ U		7.36E-08	2.62E-09	2.62E-09	2.62E-09	2.62E-09	2.62E-09	2.62E-09	
²³⁴ U		7.21E-08	2.58E-09	2.58E-09	2.58E-09	2.58E-09	2.58E-09	2.58E-09	
²³⁵ U		6.81E-08	2.45E-09	2.46E-09	2.45E-09	2.43E-09	2.45E-09	2.52E-09	
²³⁶ U		6.83E-08	2.45E-09	2.45E-09	2.45E-09	2.45E-09	2.45E-09	2.45E-09	
²³⁷ U		5.69E-11	5.04E-12	1.46E-11	1.21E-11	7.42E-13	2.31E-13	7.38E-11	
²³⁸ U		6.80E-08	2.30E-09	2.30E-09	2.30E-09	2.30E-09	2.30E-09	2.30E-09	
²⁴⁰ U		2.62E-11	5.95E-12	1.69E-11	9.56E-12	1.52E-12	5.59E-13	5.62E-11	
^{240m} Np	1.0000	Note: Contribution included with parent.							
²³⁷ Np		2.18E-06	9.97E-11	1.00E-10	2.46E-07	8.18E-11	1.10E-10	9.69E-11	
²³⁸ Np		2.17E-10	1.84E-11	4.63E-11	4.63E-11	4.58E-12	1.50E-12	1.64E-10	
²³⁹ Np		4.66E-11	5.04E-12	1.51E-11	1.14E-11	8.13E-13	2.07E-13	6.88E-11	
²³⁶ Pu		4.49E-09	2.32E-13	2.38E-13	7.82E-10	2.34E-13	1.56E-13	2.95E-13	
²³⁷ Pu		2.35E-11	1.82E-12	5.47E-12	4.28E-12	2.10E-13	3.28E-14	2.87E-11	
²³⁸ Pu		1.27E-08	9.14E-12	8.89E-14	2.33E-09	8.02E-14	7.99E-14	1.64E-13	
²³⁹ Pu		1.41E-08	8.17E-14	8.47E-14	2.64E-09	7.54E-14	7.50E-14	1.38E-13	
²⁴⁰ Pu		1.41E-08	8.68E-14	8.50E-14	2.64E-09	7.56E-14	7.51E-14	1.61E-13	
²⁴¹ Pu		2.78E-10	1.40E-15	1.77E-15	5.66E-11	1.04E-15	1.01E-15	1.89E-15	
²⁴² Pu		1.34E-08	1.16E-13	1.50E-13	2.51E-09	7.86E-14	7.38E-14	4.39E-13	
²⁴³ Pu		1.82E-12	1.50E-13	9.46E-13	1.65E-13	3.12E-14	5.50E-15	2.60E-12	
²⁴⁴ Pu		1.33E-08	1.97E-11	3.64E-11	2.56E-09	4.65E-12	2.22E-12	1.62E-10	
²⁴¹ Am		1.45E-06	1.61E-11	1.94E-11	2.70E-07	1.36E-11	1.32E-11	3.00E-11	
^{242m} Am		1.41E-06	6.39E-12	7.44E-12	2.66E-07	5.18E-12	3.77E-12	9.83E-12	
²⁴² Am		1.24E-10	2.41E-13	9.10E-13	1.80E-11	5.60E-14	2.61E-14	3.57E-12	
²⁴³ Am		1.44E-06	7.97E-11	1.00E-10	2.71E-07	7.30E-11	6.80E-11	1.28E-10	
²⁴² Cm		3.57E-08	8.84E-12	8.83E-12	5.20E-09	8.82E-12	8.82E-12	8.93E-12	
²⁴³ Cm		9.81E-07	3.93E-11	5.35E-11	1.72E-07	3.37E-11	3.15E-11	1.01E-10	

Table E.5 Ingestion organ dose equivalent factors for organ set 3 (Continued)

Radio-nuclide	Implicit progeny fraction	Organ name (Sv/Bq)						
		R marrow	Skin	Spleen	Testes	Thymus	Thyroid	Uterus
²⁴⁴ Cm		7.82E-07	8.57E-12	8.54E-12	1.33E-07	8.46E-12	8.44E-12	8.61E-12
²⁴⁵ Cm		1.49E-06	3.80E-11	5.04E-11	2.80E-07	3.46E-11	3.02E-11	8.40E-11
²⁴⁶ Cm		1.48E-06	2.65E-11	2.73E-11	2.77E-07	2.08E-11	1.87E-11	3.44E-11
²⁴⁷ Cm		1.36E-06	1.37E-10	1.79E-10	2.55E-07	1.40E-10	1.20E-10	2.57E-10
²⁴³ Pu	1.0000	1.82E-12	1.50E-13	9.46E-13	1.65E-13	3.12E-14	5.50E-15	2.60E-12
²⁴⁸ Cm		5.42E-06	6.60E-09	6.90E-09	1.01E-06	4.63E-09	3.87E-09	9.42E-09
²⁵² Cf		4.69E-07	6.71E-10	9.66E-10	4.83E-08	3.12E-10	2.68E-10	3.11E-09

Table E.6 Inhalation class and gastrointestinal tract uptake fractions for internal dose factors

Radionuclide	Inhalation class	GI tract uptake fraction (f ₁)	Radionuclide	Inhalation class	GI tract uptake fraction (f ₁)
³ H	V ^(a)	1.0	⁶⁵ Zn	Y	5 E-1
¹⁰ Be	Y	5 E-3	^{69m} Zn	Y	5 E-1
¹⁴ C	C ^(b)	1.0	⁶⁹ Zn	Y	5 E-1
¹⁸ F	D	1.0	⁷⁶ As	W	5 E-1
²² Na	D	1.0	⁷⁵ Se	W	8 E-1
²⁴ Na	D	1.0	⁷⁹ Se	W	8 E-1
³² P	W	8E-1	⁸² Br	W	1.0
³³ P	W	8E-1	⁸³ Br	W	1.0
³⁵ S	W	1E-1	⁸⁴ Br	D	1.0
³⁶ Cl	W	1.0	⁸⁶ Rb	D	1.0
⁴⁰ K	D	1.0	⁸⁸ Rb	D	1.0
⁴¹ Ca	W	3E-1	⁸⁹ Rb	D	1.0
⁴⁵ Ca	W	3E-1	⁸⁵ Sr	Y	3 E-1
⁴⁶ Sc	Y	1E-4	⁸⁹ Sr	Y	1 E-2
⁵¹ Cr	Y	1E-1	⁹⁰ Sr	Y	3 E-1
⁵⁴ Mn	W	1E-1	⁹¹ Sr	Y	1 E-2
⁵⁶ Mn	D	1E-1	⁹⁰ Y	Y	1 E-4
⁵⁵ Fe	D	1E-1	^{91m} Y	Y	1 E-4
⁵⁹ Fe	D	1E-1	⁹¹ Y	Y	1 E-4
⁵⁷ Co	Y	3E-1	⁹² Y	Y	1 E-4
⁵⁸ Co	Y	3E-1	⁹³ Y	Y	1 E-4
⁶⁰ Co	Y	3E-1	⁹³ Zr	D	2 E-3
⁵⁹ Ni	V ^(a)	5E-2	⁹³ Zr+C ^(c) (Values for each chain member are used.)		
⁶³ Ni	V ^(a)	5E-2	⁹⁵ Zr	D	2 E-3
⁶⁵ Ni	V ^(a)	5E-2	⁹⁷ Zr	Y	2 E-3
⁶⁴ Cu	Y	5 E-1	^{93m} Nb	Y	1 E-2
			⁹⁴ Nb	Y	1 E-2
			^{95m} Nb	Y	1 E-2
			⁹⁵ Nb	Y	1 E-2
			^{97m} Nb (dose not included: short-lived)		
			⁹⁷ Nb	Y	1 E-2

Table E.6 Inhalation class and gastrointestinal tract uptake fractions for internal dose factors (Continued)

Radionuclide	Inhalation class	GI tract uptake fraction (f1)	Radionuclide	Inhalation class	GI tract uptake fraction (f1)
⁹³ Mo	Y	8 E-1	^{126m} Sb	D	1 E-2
⁹⁹ Mo	Y	5 E-2	¹²⁶ Sb	W	1 E-2
^{99m} Tc	D	8 E-1	¹²⁷ Sb	W	1 E-2
⁹⁹ Tc	D	8 E-1	^{123m} Te	W	2 E-1
¹⁰¹ Tc	D	8 E-1	^{125m} Te	W	2 E-1
¹⁰³ Ru	Y	5 E-2	^{127m} Te	W	2 E-1
¹⁰⁵ Ru	Y	5 E-2	¹²⁷ Te	W	2 E-1
¹⁰⁶ Ru	Y	5 E-2	^{129m} Te	W	2 E-1
^{103m} Rh	D	5 E-2	¹²⁹ Te	D	2 E-1
¹⁰⁵ Rh	Y	5 E-2	^{131m} Te	W	2 E-1
¹⁰³ Pd	Y	5 E-3	¹³¹ Te	D	2 E-1
¹⁰⁷ Pd	Y	5 E-3	¹³² Te	W	2 E-1
¹⁰⁹ Pd	Y	5 E-3	^{133m} Te	D	2 E-1
^{110m} Ag	Y	5 E-2	¹³³ Te	D	2 E-1
¹¹¹ Ag	Y	5 E-2	¹³⁴ Te	D	2 E-1
¹⁰⁹ Cd	D	5 E-2	¹²⁵ I	D	1.0
^{113m} Cd	D	5 E-2	¹²⁹ I	D	1.0
^{115m} Cd	D	5 E-2	¹³⁰ I	D	1.0
¹¹⁵ Cd	Y	5 E-2	¹³¹ I	D	1.0
¹¹¹ In	W	2 E-2	¹³² I	D	1.0
^{114m} In	D	2 E-2	¹³³ I	D	1.0
^{115m} In	D	2 E-2	¹³⁴ I	D	1.0
^{117m} Sn	W	2 E-2	¹³⁵ I	D	1.0
^{119m} Sn	W	2 E-2	^{134m} Cs	D	1.0
^{121m} Sn	W	2 E-2	¹³⁴ Cs	D	1.0
¹²¹ Sn	W	2 E-2	¹³⁵ Cs	D	1.0
¹²³ Sn	W	2 E-2	¹³⁶ Cs	D	1.0
¹²⁵ Sn	W	2 E-2	¹³⁷ Cs	D	1.0
¹²⁶ Sn	W	2 E-2	¹³⁸ Cs	D	1.0
¹²⁶ Sn+C ^(c) (Values for each chain member are used.)			¹³⁹ Ba	D	1 E-1
¹²⁴ Sb	W	1 E-2	¹⁴⁰ Ba	D	1 E-1
¹²⁵ Sb	W	1 E-1	¹⁴¹ Ba	D	1 E-1
			¹⁴² Ba	D	1 E-1
			¹⁴⁰ La	W	1E-3
			¹⁴¹ La	D	1E-3
			¹⁴² La	D	1E-3

Table E.6 Inhalation class and gastrointestinal tract uptake fractions for internal dose factors (Continued)

Radionuclide	Inhalation class	GI tract uptake fraction (f1)	Radionuclide	Inhalation class	GI tract uptake fraction (f1)
¹⁴¹ Ce	Y	3E-4	²¹² Bi	D	5E-2
¹⁴³ Ce	Y	3E-4	²¹⁰ Po	D	1E-1
¹⁴⁴ Ce	Y	3E-4	²²² Rn ^(d) (Values for each chain member are used.)		
¹⁴³ Pr	Y	3E-4	²²³ Ra	W	2E-1
¹⁴⁴ Pr	Y	3E-4	²²⁴ Ra	W	2E-1
¹⁴⁷ Nd	Y	3E-4	²²⁵ Ra	W	2E-1
¹⁴⁷ Pm	Y	3E-4	²²⁶ Ra	W	2E-1
^{148^m} Pm	Y	3E-4	²²⁶ Ra+C ^(c) (Values for each chain member are used.)		
¹⁴⁸ Pm	Y	3E-4	²²⁸ Ra	W	2E-1
¹⁴⁹ Pm	Y	3E-4	²²⁵ Ac	D	1E-3
¹⁵¹ Pm	Y	3E-4	²²⁷ Ac	D	1E-3
¹⁴⁷ Sm	W	3E-4	²²⁷ Ac+C ^(c) (Values for each chain member are used.)		
¹⁵¹ Sm	W	3E-4	²²⁸ Ac	D	1E-3
¹⁵³ Sm	W	3E-4	²²⁷ Th	Y	2E-4
¹⁵² Eu	W	1E-3	²²⁸ Th	Y	2E-4
¹⁵⁴ Eu	W	1E-3	²²⁸ Th+C ^(c) (Values for each chain member are used.)		
¹⁵⁵ Eu	W	1E-3	²²⁹ Th	W	2E-4
¹⁵⁶ Eu	W	1E-3	²²⁹ Th+C ^(c) (Values for each chain member are used.)		
¹⁵³ Gd	D	3E-4	²³⁰ Th	W	2E-4
¹⁶⁰ Tb	W	3E-4	²³⁰ Th+C ^(c) (Values for each chain member are used.)		
^{166^m} Ho	W	3E-4	²³¹ Th	Y	2E-4
¹⁸¹ W	D	1E-2	²³² Th	W	2E-4
¹⁸⁵ W	W	1E-2	²³² Th+C ^(c) (Values for each chain member are used.)		
¹⁸⁷ W	D	1E-2	²³¹ Pa	W	1E-3
¹⁸⁷ Re	W	8E-1	²³¹ Pa+C ^(c) (Values for each chain member are used.)		
¹⁸⁵ Os	D	1E-2	²³³ Pa	Y	1E-3
¹⁹¹ Os	Y	1E-2	²³⁴ Pa	Y	1E-3
¹⁹² Ir	Y	1E-2			
¹⁹² Ir	Y	1E-2			
¹⁹⁸ Au	Y	1E-1			
²⁰³ Hg	D	1.0			
²¹⁰ Pb	D	2E-1			
²¹² Pb	D	2E-1			
²¹⁰ Bi	W	5E-2			

Table E.6 Inhalation class and gastrointestinal tract uptake fractions for internal dose factors (Continued)

Radionuclide	Inhalation class	GI tract uptake fraction (f1)	Radionuclide	Inhalation class	GI tract uptake fraction (f1)
²³² U	Y	5E-2	^{242m} Am	W	1E-3
²³² U+C ^(c) (Values for each chain member are used.)			²⁴² Am	W	1E-3
²³³ U	Y	5E-2	²⁴³ Am	W	1E-3
²³³ U+C ^(c) (Values for each chain member are used.)			²⁴² Cm	W	1E-3
²³⁴ U	Y	5E-2	²⁴³ Cm	W	1E-3
²³⁵ U	Y	5E-2	²⁴⁴ Cm	W	1E-3
²³⁵ U+C ^(c) (Values for each chain member are used.)			²⁴⁵ Cm	W	1E-3
²³⁶ U	Y	5E-2	²⁴⁶ Cm	W	1E-3
²³⁷ U	Y	2E-3	²⁴⁷ Cm	W	1E-3
²³⁸ U	Y	5E-2	²⁴⁸ Cm	W	1E-3
U-Nat ^(f) (same as ²³⁴ U, ²³⁵ U, and ²³⁸ U)			²⁵² Cf	Y	1E-3
²³⁸ U+C ^(c) (Values for each chain member are used.)					
²⁴⁰ U	Y	2E-3			
²³⁷ Np	W	1E-3			
²³⁷ Np+C ^(c) (Values for each chain member are used.)					
²³⁸ Np	W	1E-3			
²³⁹ Np	W	1E-3			
²³⁶ Pu	Y	1E-5			
²³⁷ Pu	Y	1E-5			
²³⁸ Pu	Y	1E-5			
²³⁹ Pu	Y	1E-5			
²⁴⁰ Pu	Y	1E-5			
²⁴¹ Pu	Y	1E-5			
²⁴² Pu	Y	1E-5			
²⁴³ Pu	Y	1E-5			
²⁴⁴ Pu	Y	1E-5			
²⁴¹ Am	W	1E-3			

(a) V denotes that intake is in the form of vapor.

(b) C denotes ¹⁴C is treated as labeled organic compounds.

(c) Radioactive decay chain members with half-lives less than 9 hours and less than 10% of the half-life of the parent are included with the parent. For decay chains having two or more radionuclides that reach secular equilibrium (i.e., a constant activity ratio as a function of time), a "+C" notation is included when all progeny of the chain member have half-lives less than 10% of the half-life of the listed member.

(d) The dose factors for ²²²Rn represent the dose from short-lived daughters that are in equilibrium with the parent radon. These entries are provided because ²²²Rn is an explicit daughter of ²²⁶Ra and dose values for all explicit daughters are needed to estimate dose for non-equilibrium cases.

(e) Where Th-Nat includes an equilibrium mixture of ²³²Th plus 10 daughters in the decay chain. Note that the dose entries for Th-Nat are equal to those for ²³²Th+C.

(f) Where 1 Ci U-Nat equals 48.9% ²³⁸U plus 48.9% ²³⁴U plus 2.25% ²³⁵U.

Appendix F

Glossary

Appendix F

Glossary

Absorbed dose - The energy imparted by ionizing radiation per unit mass of irradiated material. The units of absorbed dose are the rad and the gray (Gy).

Activity - The rate of disintegration (transformation) or decay of radioactive material. The units of activity are the curie (Ci) and the becquerel (Bq).

Airborne radioactive material - Radioactive material dispersed in the air in the form of dusts, fumes, particulates, mists, vapors, or gases.

Annual total effective dose equivalent (annual TEDE) - The total effective dose equivalent (TEDE) received during a year of exposure. The duration of exposure for each pathway is determined by the scenario considered and need not be 8766 h/y. For example, an individual may reside or work at a contaminated site for only a fraction of the year.

Class (or "lung class" or "inhalation class") - A classification scheme for inhaled material according to its rate of clearance from the pulmonary region of the lung. Materials are classified as D, W, or Y, and apply to a range of clearance half-times for D(Days) of less than 10 days, for W(Weeks) from 10 to 100 days, and for Y(Years) of greater than 100 days.

Collective dose - The sum of the individual doses received in a given period of time by a specified population from exposure to a specified source of radiation.

Committed dose equivalent ($H_{T,50}$) - The dose equivalent to organs or tissues of reference (T) that will be received from an intake of radioactive material by an individual during the 50-year period following the intake.

Committed effective dose equivalent ($H_{E,50}$) - The sum of the products of the weighting factors applicable to each of the body organs or tissues that are irradiated by internally deposited radionuclides and the committed dose equivalent to these organs or tissues ($H_{E,50} = \sum w_T H_{T,50}$).

Conservative - The application of a cautious approach to a dose analysis that is likely to produce an overestimate of the expected result. A conservative analysis involves the deliberate selection of parameter values that maximize the expected result.

Deep dose equivalent (H_d) - Applied to external whole-body exposure, H_d is the dose equivalent at a tissue depth of 1 cm (1000 mg/cm²). Note: for this generic application, the annual TEDE is calculated using the external effective dose equivalent, using dose factors from the U.S. Environmental Protection Agency (EPA), as described in Section 6.

Dose or "radiation dose" - A generic term that means absorbed dose, dose equivalent, effective dose equivalent, committed dose equivalent, committed effective dose equivalent, or total effective dose equivalent, as defined in other paragraphs of this appendix.

Appendix F

Dose equivalent (H_T) - The product of the absorbed dose in tissue, quality factor, and all other necessary modifying factors at the location of interest. The units of dose equivalent are the rem and sievert (Sv).

Effective dose equivalent (H_E) - The sum of the products of the dose equivalent to the organ or tissue (H_T) and the weight factors (w_T) applicable to each of the body organs or tissues that are irradiated ($H_E = \sum w_T H_T$).

Exposure - Being exposed to ionizing radiation or to radioactive material.

External dose - That portion of the dose equivalent received from radiation sources outside of the body.

Gray (Gy) - The SI unit of absorbed dose. One gray is equal to an absorbed dose of 1 joule/kg (100 rad).

Internal dose - That portion of the dose equivalent received from radioactive material taken into the body.

Licensed material - Source material, special nuclear material, or byproduct material received, possessed, used, or transferred under a general or specific license issued by the U.S. Nuclear Regulatory Commission (NRC).

Member of the public - An individual in a uncontrolled or unrestricted area. However, an individual is not a member of the public during any period in which the individual receives an occupational dose.

NRC - The U.S. Nuclear Regulatory Commission or its duly authorized representatives.

Pathway - The potential routes through which people may be exposed to radiation or radioactive materials. Typical radiation exposure pathways include external exposure to penetrating radiation, inhalation of airborne materials, and ingestion of materials contained in surface contamination, food products, or drinking water.

Public dose - The dose received by a member of the public from exposure to radiation and to radioactive material released by a licensee, or to another source of radiation either within a licensee's controlled area or in unrestricted areas. It does not include occupational dose, or dose received from natural background, as a patient from medical practices, or from voluntary participation in medical research programs.

Rad - The special unit of absorbed dose. One rad is equal to an absorbed dose of 100 ergs/g or 0.01 joule/kg (0.01 gray).

Radiation (ionizing radiation) - Alpha particles, beta particles, gamma rays, x-rays, neutrons, high-speed electrons, high-speed protons, and other particles capable of producing ions. Radiation, as used here, does not include nonionizing radiation, such as sound, radio, or microwaves, or visible, infrared, or ultraviolet light.

Reference man - A hypothetical aggregation of human physical and physiological characteristics arrived at by international consensus. These characteristics may be used by researchers and public health workers to standardize results of experiments and to relate biological insult to a common base.

Rem - The special unit of dose equivalent. The dose equivalent in rem is equal to the absorbed dose in rad multiplied by the quality factor (1 rem = 0.01 Sv).

Scenario - A combination of radiation exposure pathways used to model conceptually the potential conditions, events, and processes that result in radiation exposure to individuals or groups of people.

Sievert - The SI unit of dose equivalent. The dose equivalent in sieverts is equal to the absorbed dose in grays multiplied by the quality factor (1 Sv = 100 rem).

Total effective dose equivalent (TEDE) - The sum of the deep dose equivalent (for external exposures) and the committed effective dose equivalent (for internal exposures).

Uranium fuel cycle - The operations of milling of uranium ore, chemical conversion of uranium, isotopic enrichment of uranium, fabrication of uranium fuel, generation of electricity by a light-water-cooled nuclear power plant using uranium fuel, and reprocessing of spent uranium fuel, to the extent that these activities directly support the production of electrical power for public use. The uranium fuel cycle does not include mining operations, operations at waste disposal sites, transportation of radioactive material in support of these operations, and the reuse of recovered non-uranium special nuclear and byproduct materials from the cycle.

Weighting factor, w_T for an organ or tissue (T) - The proportion of the risk of stochastic effects resulting from irradiation of that organ or tissue to the total risk of stochastic effects when the whole body is irradiated uniformly. For calculating the effective dose equivalent, the values of w_T are:

Organ or tissue	w_T
Gonads	0.25
Breast	0.15
Red bone marrow	0.12
Lung	0.12
Thyroid	0.03
Bone surfaces	0.03
Remainder	0.30*
Whole body	1.0**

* 0.30 results from 0.06 for each of 5 "remainder organs" (excluding the skin and the lens of the eye) which receive the highest doses.

**For the purpose of weighting the external whole-body dose (for adding it to the internal dose), a single weight factor, $w_T = 1.0$, has been specified. The use of other weighting factors for external exposure will be approved on a case-by-case basis until such time as specific guidance is issued.

Whole body - For purposes of external exposure, head, trunk (including male gonads), arms above the elbow, and legs above the knee.

DISTRIBUTION

No of
Copies

No of
Copies

OFFSITE

U.S. Nuclear Regulatory
Division of Technical Information
and Document Control
7920 Norfolk Avenue
Washington, DC 20555

10 R. A. Meck
U.S. Nuclear Regulatory
Commission
Division of Regulatory Application
Office of Nuclear Regulatory Research
Washington, DC 20555

10 D. A. Cool, Chief
Radiation Protection & Health
Effects Branch
U.S. Nuclear Regulatory Commission
Division of Regulatory Application
Office of Nuclear Regulatory
Research
Washington, DC 20555

Director, Office of NMSS
U.S. Nuclear Regulatory
Commission
Washington, DC 20555

Director, Division of Waste
Management
U.S. Nuclear Regulatory
Commission
Washington, DC 20555

John Austin
Office of Nuclear Material
Safety & Safeguards
U.S. Nuclear Regulatory
Commission
Washington, DC 20555

Jack Bell
Office of Nuclear Reactor
Regulation
U.S. Nuclear Regulatory Commission
Washington, DC 20555

Regis Boyle
Office of Nuclear Material
Safety & Safeguards
U.S. Nuclear Regulatory
Commission
Washington, DC 20555

George Brown
Office for Analysis & Evaluation
U.S. Nuclear Regulatory
Commission
Washington, DC 20555

John Buchanan
Office of Nuclear Reactor Regulation
U.S. Nuclear Regulatory Commission
Washington, DC 20555

Richard Codell
Office of Nuclear Material Safety &
Safeguards
U.S. Nuclear Regulatory Commission
Washington, DC 20555

Christine M. Daily
Office of Nuclear material Safety &
Safeguards
U.S. Nuclear Regulatory
Washington, DC 20555

No of
Copies

No of
Copies

Rateb Eid
Office of Nuclear Material
Safety & Safeguards
U.S. Nuclear Regulatory
Commission
Washington, DC 20555

William Lahs
Office of Nuclear Material
Safety & Safeguards
U.S. Nuclear Regulatory
Commission
Washington, DC 20555

Peter Erickson
Office of Nuclear Reactor Regulation
U.S. Nuclear Regulatory
Commission
Washington, DC 20555

Catherine Mattsen
Office of Nuclear Regulatory
Research
U.S. Nuclear Regulatory
Commission
Washington, DC 20555

David Fauver
Office of Nuclear Material
Safety & Safeguards
U.S. Nuclear Regulatory
Commission
Washington, DC 20555

Thomas Nicholson
Office of Nuclear Regulatory Research
U.S. Nuclear Regulatory Commission
Washington, DC 20555

Carl Feldman
Office of Nuclear Reactor Regulation
U.S. Nuclear Regulatory Commission
Washington, DC 20555

George Ed Powers
Office of Nuclear Regulatory
Research
U.S. Nuclear Regulatory
Commission
Washington, DC 20555

John Hickey
Office of Nuclear Material
Safety & Safeguards
U.S. Nuclear Regulatory
Commission
Washington, DC 20555

Kevin Ramsey
Office of Nuclear Material
Safety & Safeguards
U.S. Nuclear Regulatory
Commission
Washington, DC 20555

Charles Hinson
Office of Nuclear Reactor Regulation
U.S. Nuclear Regulatory
Commission
Washington, DC 20555

Fredrick Ross
Office of Nuclear Material
Safety & Safeguards
U.S. Nuclear Regulatory
Commission
Washington, DC 20555

Davis Hurt
Office of Nuclear Material
Safety & Safeguards
U.S. Nuclear Regulatory
Commission
Washington, DC 20555

No of
Copies

No of
Copies

Edward Shum
Office of Nuclear Material
Safety & Safeguards
U.S. Nuclear Regulatory
Commission
Washington, DC 20555

Dennis Solenberger
Office of Governmental
and Public Affairs
U.S. Nuclear Regulatory
Commission
Washington, DC 20555

R. John Starmer
Office of Nuclear Material
Safety & Safeguards
U.S. Nuclear Regulatory
Commission
Washington, DC 20555

Jerry Swift
Office of Nuclear Material
Safety & Safeguards
U.S. Nuclear Regulatory
Commission
Washington, DC 20555

Michael Weber Office of Nuclear Material
Safety & Safeguards
U.S. Nuclear Regulatory Commission
Washington, DC 20555

Lynn Anspaugh
Lawrence Livermore National Lab
7000 East Avenue
Livermore, CA 94550

Dr. Thomas E. Blue
Ohio State University
2091 Robinson Laboratory
206 West 18th Avenue
Columbus, OH 43210

Dr. Thomas B. Borak
Department of Radiological Health
Sciences
Colorado State University
Ft. Collins, CO 80523

Dr. Alan K. Bruce
State University of New York at Buffalo
Cook Hall - Biology
Buffalo, NY 14260

Dr. Wesley E. Bolch
Department of Nuclear Engineering
Texas A&M University
129 Zachry
College Station, TX 77843-3133

Dr. Robert D. Busch
Department of Chemical and Nuclear
Engineering
University of New Mexico
FEC 209
Albuquerque, NM 87131-1341

Kenneth C. Brog
Decontamination and
Decommissioning Operations
Battelle Memorial Institute
505 King Avenue
Columbus, OH 43201-2693

Dr. Herman Cember
McCormick School of Engineering &
Applied Science
Northwestern University
Evanston, IL 60208

Dr. Ralph C. Christensen
Division of Radiation Sciences
Room 130 Medical Center Annex 2
Lexington, KY 40536-0080

No of
Copies

Dr. Ralph C. Christensen
Division of Radiation Sciences
Room 130 Medical Center Annex 2
Lexington, KY 40536-0080

Dr. Gregg Claycamp
Department of Environmental and
Occupational Health
University of Pittsburgh
130 DeSotto Street
Pittsburgh, PA 15261

Dr. Norman Cohen
Laboratory for Radiological Studies
Institute of Environmental Medicine
New York University Medical Center
Sterling Lake Road
Tuxedo, NY 10987

Dr. Jack G. Couch
Physics Department
Bloomsburg University
Bloomsburg, PA 17815

William Condon
New York State Department of
Health
Bureau of Environmental
Radiation Protection
Environmental Radiation Section
2 University Plaza
Albany, NY 12237

Dr. James C.H. Chu
Department of Medical Physics
Rush-Presbyterian-St. Luke's Medical
Center
Chicago, IL 60612

No of
Copies

Dr. Paul M. DeLuca, Jr.
Department of Medical Physics
University of Wisconsin - Madison
1530 Medical Sciences Center
1300 University Avenue
Madison, WI 53706-1532

Dr. Brian Dodd
Department of Nuclear Engineering
Oregon State University
Radiation Center C116
Corvallis, OR 97331-5902

Donald E. Dunning, Jr.
Environmental Assessment and
Information Sciences Division
9700 South Cass Avenue
EID/900
Argonne, IL 60439-4832

Dr. Roy Eckart
Department of Mechanical, Industrial
& Nuclear Engineering
University of Cincinnati
ML 72
Cincinnati, OH 45221-0072

Dr. Robert A. Fjeld
Department of Environmental Systems
Engineering
Clemson University
Clemson Research Park
Clemson, SC 29634-0919

Ms. Donna R. Foster
Northern New Mexico Community
College
1002 N. Onate
Española, NM 87532

No of
Copies

Dr. Gary D. Fullerton
Department of Radiology
University of Texas Health Science Center
- San Antonio
7703 Floyd Curl Drive
San Antonio, TX 78284-7800

Keith Eckerman
Oak Ridge National Laboratory
PO Box X
Oak Ridge, TN 37830

Dr. Peter A. J. Englert
Nuclear Science Facility
San Jose State University
One Washington Square
San Jose, CA 95192-0163

Dr. Douglas G. Gossen
Health Physics Department
Lakeshore Technical College
1290 North Avenue
Cleveland, WI 53015

Roger W. Granlund
Health Physics Office
The Pennsylvania State University
228 Academic Projects Building
University Park, PA 16802

Wayne Hansen
Los Alamos National Laboratory
PO Box 1663
Los Alamos, NM 87545

Dr. Jesse Y. Harris
Radiological Sciences Program
Department of Physics
University of Massachusetts at Lowell
1 University Avenue
Lowell, MA 01854

No of
Copies

Dr. Francis J. Haughey
Radiation Science Program
Rutgers University
Building 4087
Livingston Campus
New Brunswick, NJ 08903

Dr. Lynn D. Hendrick
Department of Chemistry & Physics
Francis Marion College
PO Box 100547
Florence, SC 29501

Dr. Charles T. Hess
Department of Physics
University of Maine
Bennett Hall
Orono, ME 04469

Dr. David E. Hintelang
Department of Nuclear Engineering
Sciences
University of Florida
202 Nuclear Sciences Center
Gainesville, FL 32611

Ellen Hochheiser
Salem Community College
460 Hollywood Avenue
Carneys Point, NJ 08069

Dr. Keith E. Holbert
Nuclear Engineering Science Program
Electrical & Computer Engineering
Department
Tempe, AZ 85287-5706

Cort Horton
Decontamination and Decommissioning
Operations
Battelle Memorial Institute
505 King Avenue
Columbus, OH 43201-2693

No of
Copies

Lawrence Hough
Department of Radiological & Health
Sciences
Riverdale, NY 10471

Dr. H. K. Huang
Department of Radiological Sciences
Biomedical Physics Graduate Program
University of California - Los Angeles
AR-277 CHS
Los Angeles, CA 90024-1721

George E. Kirsch
RC and HP Oversight operational and
Environmental Health Physics
Battelle Memorial Institute
505 King Avenue
Columbus, OH 43201-2693

Will Ivie
Office of Radiation Safety
Case Western Reserve University
10900 Euclid
Cleveland, OH 44106

Dr. Timothy K. Johnson
Department of Radiology
University of Colorado Health Science
Center
C-278, 4200 East 9th Avenue
Denver, CO 80262

David C. Kocher
Oak Ridge National Laboratory
Building 7509
PO Box 2008
Oak Ridge, TN 37832

No of
Copies

Dr. E. N. Lambremont
Nuclear Science Center
Baton Rouge, LA 70803-5820

David Layton
Los Alamos National Laboratory
PO Box 1663
Los Alamos, NM 87545

David C. Langstaff
U.S. Department of Energy
Richland Field Office
PO Box 550 A5-90
Richland, WA 99352

Albert M. F. Lau
Physical Science Department
Sandia National Laboratories
Livermore, CA 94551-0969

Dr. E. N. Lambremont
Nuclear Science Center
Louisiana State University
Baton Rouge, LA 70803-5820

Dr. Robert R. Landolt
School of Health Sciences
Purdue University
Civil Building
West Lafayette, IN 47907

Don Lee
Oak Ridge National Laboratory
PO Box 2008
Oak Ridge, TN 37832

Gene Leyendecker
Waste Water Utilities
Division City of Albuquerque
4201 Second Street SW
Albuquerque, NM 87015

No of
Copies

Dr. Abraham R. Liboff
Department of Physics
Oakland University
Rochester, MI 48309-4401

Dr. James E. Martin
School of Public Health
University of Michigan
Ann Arbor, MI 48109-2029

Dr. John Luetzelschwab
Department of Physics and Astronomy
Dickinson College
Carlisle, PA 17013-2896

Jerome B. Martin
Battelle Pantax
PO BOX 30020
Amarillo, TX 79117

Charles Massey
Sandia National Laboratory
PO Box 5800
Division 7722
Albuquerque, NM 07185

Richard W. McKinley
Department of Health Services
Health and Welfare Agency
State of California
8455 Jackson Road, Suite 120
Sacramento, CA 95826

Charles W. Miller, Ph.D.
Radiation Studies Branch
Centers for Disease Control
Mail Stop F-28
1600 Clifton Road
Atlanta, GA 30333

No of
Copies

Dr. Laurence F. Miller
Department of Nuclear Engineering
University of Tennessee - Knoxville
208 Pasqua Nuclear Engineering Building
Knoxville, TN 37996-2300

Dr. William Miller
Nuclear Engineering Program
University of Missouri-Columbia
333 EBW
Columbia, MI 65211

Dr. Larry D. Milne
University of Arkansas for Medical
Sciences
Slot #522
4301 W. Markham Street
Little Rock, AR 72205

Dr. Dade W. Moeller
Office of Continuing Education
Harvard School of Public Health
677 Huntington Avenue
Boston, MA 02115

Dr. Sabee Molloy
Department of Radiology
University of California - Irvine
Medical Sciences I, B140
Irvine, CA 92717

National Technological University
Health Physics Program
700 Centre Avenue
Fort Collins, CO 80526-9903

No of
Copies

No of
Copies

Dr. James H. O'Rear
Physics Department
Idaho State University
Campus Box 8106
Pocatello, ID 83209

Dr. James W. Osborne
Radiation Research Laboratory
University of Iowa
14 Medical Laboratories
Iowa City, IA 52242

Dr. Patrick J. Papin
Department of Physics
San Diego State University
San Diego, CA 92182

Hal Peterson
U.S. Department of Energy
Forrestal Building - MS EH-23
Washington, DC 20585

Dr. William J. Potvin
Department of Radiology
Medical College of Ohio
PO Box 10008
Toledo, OH 43699

Dr. James E. Rodgers
Department of Radiation Science LL Bles
Georgetown University
3800 Reservoir Road
Washington, DC 20007

Professor Robert M. Ryan
Department of Nuclear Engineering and
Engineering Physics
Rensselaer Polytechnic Institute
Troy, NY 12180-3590

Dr. Charles E. Roessler/
W. Emmet Bolch
Department of Environmental
Engineering Sciences
University of Florida
A.P. Black Hall
Gainesville, FL 32611

Keith J. Schiager
ALARA, Inc.
3671 Millbrook Terrace
Salt Lake City, UT 84106

Dr. Daniel D. Sprau
Department of Physics
East Carolina University
Greenville, NC 27858-4353

Dr. R. Gene Schreckhise
Environmental Science program
Washington State University
MSIN: K3-54
Richland, WA 99352

John Till
Radiological Assessments Corporation
Rt. 2, Box 122
Neeses, SC 29107

Dr. William F. Tivol
School of Public Health
Wadsworth Center for Laboratories and
Research
State University of New York at Albany
Empire State Plaza
Albany, NY 12201-0509

Dr. Nicholas Tsoulfanidis
Department of Nuclear Engineering
University of Missouri-Rolla
225 Fulton Hall
Rolla, MI 65401

No of
Copies

Dr. Henry N. Wagner
615 North Wolfe Street
Baltimore, MD 21205-2179

Andy Wallo III
Air, Water and Radiation
Division, EH-232
U.S. Department of Energy
1000 Independence Avenue S.W.
Washington, DC 20585

Dr. James E. Watson, Jr
Department of Environmental Science
and Engineering
University of North Carolina
Chapel Hill, NC 27599-7400

Dr. William J. Wepfer
Associate Director
G.W. Woodruff School of Mechanical
Engineering
Georgia Institute of Technology
Atlanta, GA 30332-0405

Ward F. Whicker
Department of Radiology &
Radiation Biology
Colorado State University
Fort Collins, CO 80523

Richard Wheet
Nuclear Technology Department
Texas State Technical College at Waco
3801 Campus Drive
Waco, TX 76705

Dr. Jacquelyn C. Yanch
Massachusetts Institute of Technology
45 Carleton Street
E25-326
Cambridge, MA 02140

No of
Copies

Charley Yu
Argonne National Laboratory
9700 South Cass Avenue, Bldg 362
Argonne, IL 60439-4815

Paul Ziemer
U.S. Department of Energy
1000 Independence Avenue S.W. EH-1
Washington, DC 20585

FOREIGN

L. Baekelandt
Organisme National des Dechets
Radioactifs et des Matieres Fissiles
"ONDRAF"
Place Madou 1 - B^{tes} 24/25
1030 Bruxelles
Brussels
BELGIUM

G. Fraser
Commission of the European
Communities
Batiement Jean Monnet
Pateau du Kirchberg L-2920
LUXEMBORG

Michele Laraia
ENEA/DISP
Via Vitaliano Brancati, 48
00144
ROME

Gordon Linsley
International Atomic Energy
Agency (IAEA)
Division of Nuclear Fuel Cycle
Waste Management Fuel Cycle
Wagramerstrasse 5
P.O. Box 100, A-1400
Vienna
AUSTRIA

No of
Copies

Marsha Sheppard
Atomic Energy of Canada Limited
Research Company
Whiteshell Nuclear Research
Establishment
Pinawa, Manitoba
ROEIL0
CANADA

Yuji Nakamura
National Institute of
Radiological Sciences
9-1, Anagawa-4
Chiba 260
JAPAN

Marlene Sauk
Atomic Energy of Canada Limited
Scientific Document Distribution
Office
Station 14
Chalk River Nuclear Laboratories
Chalk River, Ontario
KOJ 1JO
CANADA

Graham M. Smith
Environmental Sciences Group
Intera-Exploration Consultants, Limited
Highlands Farm, Greys Road
Henley-on-Thames
Oxon RG9 4PS
ENGLAND

No of
Copies

ONSITE

50 Pacific Northwest Laboratory

W. J. Bair
C. R. Cole
E. E. Hickey
T. A. Ikenberry
D. J. Hanley
J. R. Johnson
W. E. Kennedy, Jr. (10)
R. A. Kennedy (10)
C. T. Kincaid
B. A. Napier
S. M. Neuder
L. H. Sawyer
J. M. Selby
S. F. Snyder
J. K. Soldat
P. S. Stansbury
D. L. Strenge (10)
D. J. Strom
HPD Technical Library
NRC Program Office Publishing
Coordinator (2)
Technical Information RL
Office (2)

NRC FORM 335 (2-89) NRCM 1102, 3201, 3202	U.S. NUCLEAR REGULATORY COMMISSION	1. REPORT NUMBER (Assigned by NRC. Add Vol., Supp., Rev., and Addendum Numbers, if any.) NUREG/CR-5512 PNL-7994 Vol. 1				
BIBLIOGRAPHIC DATA SHEET <i>(See instructions on the reverse)</i>		3. DATE REPORT PUBLISHED <table border="1" style="width: 100%;"> <tr> <td style="text-align: center;">MONTH</td> <td style="text-align: center;">YEAR</td> </tr> <tr> <td style="text-align: center;">October</td> <td style="text-align: center;">1992</td> </tr> </table>	MONTH	YEAR	October	1992
MONTH	YEAR					
October	1992					
2. TITLE AND SUBTITLE Residual Radioactive Contamination From Decommissioning Technical Basis for Translating Contamination Levels to Annual Total Effective Dose Equivalent Final Report		4. FIN OR GRANT NUMBER B2908				
5. AUTHOR(S) W. E. Kennedy, Jr., D. L. Strenge		6. TYPE OF REPORT Technical				
8. PERFORMING ORGANIZATION - NAME AND ADDRESS <i>(If NRC, provide Division, Office or Region, U.S. Nuclear Regulatory Commission, and mailing address; if contractor, provide name and mailing address.)</i> Pacific Northwest Laboratory Richland, WA 99352		7. PERIOD COVERED <i>(Inclusive Dates)</i>				
9. SPONSORING ORGANIZATION - NAME AND ADDRESS <i>(If NRC, type "Same as above"; if contractor, provide NRC Division, Office or Region, U.S. Nuclear Regulatory Commission, and mailing address.)</i> Division of Regulatory Applications Office of Nuclear Regulatory Research U.S. Nuclear Regulatory Commission Washington, DC 20555						
10. SUPPLEMENTARY NOTES						
11. ABSTRACT <i>(200 words or less)</i> <p> This document is the first volume of a three-volume report to provide generic and site-specific estimates of radiation dose for exposures to residual radioactive contamination after decommissioning of facilities licensed by the U.S. Nuclear Regulatory Commission (NRC). The detail included in this volume serves as the basis for user-friendly computer software developed under strict quality-assurance procedures. Volume 1 describes the scenarios, models, mathematical formulations, assumptions, and justifications of parameter selections. The generic modeling addresses residual radioactive contamination inside buildings and in soils. For buildings, two scenarios are presented to relate volume and surface contamination levels to estimates of the annual total effective dose equivalent (TEDE), as defined in 10 CFR 20, received during a year of exposure. Because of concerns about potential ground-water contamination, a generic water-use model was developed to permit evaluation of the annual TEDE for drinking water from wells. The generic water-use model was also used in the evaluation of multiple pathways associated with contaminated soil. The information in this volume is intended to serve as the technical basis for the NRC's derivation of screening values supporting its development of policy applied to residual radioactive contamination from decommissioning. </p>						
12. KEY WORDS/DESCRIPTORS <i>(List words or phrases that will assist researchers in locating the report.)</i> Decommissioning, Residual Radioactivity, Pathway Analysis		13. AVAILABILITY STATEMENT Unlimited 14. SECURITY CLASSIFICATION <i>(This Page)</i> Unclassified <i>(This Report)</i> Unclassified 15. NUMBER OF PAGES 16. PRICE				